



# Safety Equipment

Main Catalogue 2012/2013



# New Products



# Safety Equipment

## PHE III M12 / ZK Voltage Detector Kit

- Safe verification of isolation from supply voltage
- 30 to 60 kV / 50 Hz

- Wide nominal voltage range  
10 to 30 kV / 50 Hz and 60 to 110 kV / 50 Hz

See page 21 / 23

## Earthing Sticks

- Two-part design allows easy transport
- With plug-in coupling for extending the handle

See page 104

## PHE/G I d.c. Voltage Detector for Switchgear Installations

- Modular versions up to 24 kV d.c.
- Great insertion depth
- Earth clamp with adjustable handle and magnet

See page 30 / 171

## PHE/G I d.c. Voltage Detector for Switchgear Installations

- Modular versions up to 24 kV d.c.
- Great insertion depth
- Earth clamp with adjustable handle and magnet

See page 30 / 171

## PHE/G II d.c. Voltage Detector for Switchgear Installations and d.c. Links

- Modular versions up to 24 kV d.c.
- Great insertion depth

See page 31 / 172

## Earthing and Short-circuiting Configurator

- Easy online selection of the adequate earthing and short-circuiting device
- Clear laser printing of the earthing and short-circuiting device
- Individual configuration
- Permanent plausibility check in the background

See page 73

EaS Configurator:  
[www.dehn.de/en/euk](http://www.dehn.de/en/euk)

See page 89

## Safety Helmet for Electricians

- For nominal voltages up to 1000 V
- Adjustable to head sizes from 51 to 62 cm via knob

See page 151

## Face Shield

- Arc-fault-tested in accordance with GS-ET-29 (class 2, 423 kJ/m<sup>2</sup>) and ASTM F2178 (6 cal/cm<sup>2</sup> and 12 cal/cm<sup>2</sup>)
- Energy absorbing nanoparticles homogeneously dispersed in the material ensure a high degree of protection and wear resistance

See page 151

# Safety Equipment for electric Railways

## PHE III Voltage detector Kit

- With 110 to 132 kV / 50 Hz and 16.7 Hz
- Voltage detector for 50 Hz three-phase systems and 16.7 Hz centre-earthed monophas traction current lines
- Range does not have to be switched

See page 167

## PHE III Voltage Detector

- For overhead lines of electric railways
- For single-ended monophas systems

See page 164

## Safety Equipment Main Catalogue 2012/2013

Valid as of 1<sup>st</sup> April 2012

This catalogue replaces the Safety Equipment main catalogue published in 2009/2010.

We reserve the right to introduce changes in configuration and technology, dimensions, weights and materials in the course of technical progress. Illustrations are not binding. Misprints and errors cannot be ruled out and the right to make changes is reserved.

Any reproduction of this catalogue, as a whole or in parts, is only allowed upon approval of DEHN + SÖHNE.

DS396/E/0412

**Safety Equipment**



Voltage Detectors

9



Phase Comparators

33



Voltage Detecting Systems

37



Operating Sticks

47



Insulating Protective Shutters

61



Earthing and Short-Circuiting Devices

69



Equipment for Voltages up to 1000 V

113



Further Equipment

125

**Live Working**



Live Working – Cleaning and Refilling Equipment

129



Live Working – Protective and Auxiliary Equipment

149

**Railways**



Voltage Detectors for electric Railways

161



Earthing Devices for electric Railways

173



Further Equipment

185

**Accessory**



Storage Bags and Transport Cases

187



Accessory and Kit Parts

195

Spare Parts

209

Index

211





Our promise



## DEHN protects

Our family-owned company has been specialising in surge protection, lightning protection and safety equipment for many decades. With the key objective of protecting material assets and workers, we have made a name for ourselves in the market.

It was our pioneering spirit and innovative ideas that have defined our company for more than 100 years and made us a market leader with more than 1,400 employees. Our products and developments reflect our market feasibility, commitment and ideas.

As early as in 1923 our founder Hans Dehn started production of external lightning protection and earthing components to optimise the protection of buildings and installations. In 1954, we launched the first series of surge protective devices. Constant further development of these devices ensures safe operation and permanent availability of electrical and electronic installations. Also in the 1950s, our third sector, safety equipment, was added to our portfolio.

The Bavarian town of Neumarkt is the heart of our activities where product managers and developers advance our protection technologies. Here we manufacture our high-quality safety products.

## We offer the best solution

Our concern is to be a reliable and fair partner for our industrial, commercial and technical customers all over the world. To this end, we always focus on the best solution to protection problems. Our sales teams in Germany and our global network of 11 subsidiaries as well as more than 70 international sales partners are committed to competent and customer-oriented distribution of our products. Proximity and close contact with our customers is of utmost importance to us, be it on-site support by our experienced field staff team, our telephone hotline or personal contact at trade fairs.

In hundreds of seminar, workshops and conferences held every year throughout the world we impart practical knowledge on products and solutions.

Our specialised book "Lightning Protection Guide" and our brochures will broaden your practical knowledge. Or visit us at [www.dehn.de](http://www.dehn.de) for more information.

DEHN stands for innovation, highest quality and consistent customer and market orientation – also in the future.



Thomas Dehn

Dr. Peter Zahlmann

Dr. Philipp Dehn





Algeria  
 Argentina  
 Australia  
 Austria  
 Belgium  
 Belize  
 Bolivia  
 Brazil  
 Bulgaria  
 Canada  
 Cap Verde  
 Chile  
 China  
 Columbia  
 Costa Rica  
 Croatia  
 Cuba  
 Czech Republic  
 Denmark  
 El Salvador  
 Estonia  
 F.Y.R.O.M  
 Finland  
 France  
 Great Britain

Greece  
 Guatemala  
 Honduras  
 Hungary  
 Iceland  
 India  
 Iran  
 Ireland  
 Israel  
 Italy  
 Japan  
 Latvia  
 Lebanon  
 Lithuania  
 Luxembourg  
 Malaysia  
 Mauritius  
 Mexico  
 Netherlands  
 New Zealand  
 Nicaragua  
 Nigeria  
 Norway  
 Oman  
 Pakistan

Panama  
 Peru  
 Poland  
 Portugal  
 Romania  
 Russia  
 Saudi Arabia  
 Serbia  
 Singapore  
 Slovakia  
 Slovenia  
 South Africa  
 South Korea  
 Spain  
 Sri Lanka  
 Sweden  
 Switzerland  
 Syria  
 Taiwan  
 Thailand  
 Turkey  
 Uganda  
 United Arab Emirates  
 USA  
 Venezuela

We shall be pleased to name you the right contact person of our subsidiaries or representatives.

**Export Department**  
 Tel. +49 9181 906 1462  
 Fax +49 9181 906 1444  
[export@dehn.de](mailto:export@dehn.de)



### 1. VDE Regulations for safety equipment and devices

#### DIN VDE 0680

"Personal protective equipment, protective devices and apparatus for work on electrically energized systems up to 1000 V".

- Part 1 "Personal protective equipment and protective insulating devices"
- Part 3 "Operating rods and current collecting devices"
- Part 4 "Fuse handles for low-tension HRC-fuses"
- Part 6 "Single-pole voltage tester up to 250 V a.c."
- Part 7 "Socket spanner"

#### DIN VDE 0681

"Operating, testing and safe-guarding devices for work on electrically energized systems with rated voltages exceeding 1 kV"

- Part 1 "General requirements" for DIN VDE 0681 Parts 2 to 4
- Part 2 "Operating rods"
- Part 3 "Fuse tongs"
- Part 6 "Voltage detectors to be used for overhead contact systems 15 kV, 16 2/3 Hz"

#### DIN VDE 0682

"Apparatus and equipment for live working"

- Part 201 "Live working – Hand tools for use up to 1000 V a.c. and 1500 V d.c." (IEC/EN 60900)
- Part 211 "Live working – Insulating sticks and attachable devices – Part 1: Insulating sticks" (IEC/EN 60832-1:2010)
- Part 212 "Live working – Insulating sticks and attachable devices – Part 2: Attachable devices" (IEC 60832-2:2010)
- Part 213 "Multi-purpose insulating sticks for electrical operations on high voltage installations"; German version" EN 50508:2009
- Part 311 "Live working – Gloves of insulating material" (IEC/EN 60903)
- Part 312 "Sleeves of insulating material for live working" (IEC/EN 60984)
- Part 321 Electrically insulating helmets for use on low voltage installations
- Part 401 "Live working – Voltage detectors – Part 3: Two-pole low voltage type" (IEC/EN 61243-3)
- Part 411 "Live working – Voltage detectors – Part 1: Capacitive type to be used for voltages exceeding 1 kV a.c." (IEC/EN 61243-1)
- Part 412 "Live working – Voltage detectors – Part 2: Resistive type to be used for voltages of 1 kV to 36 kV" (IEC/EN 61243-2)

- Part 415 "Live working – Voltage detectors – Part 5: Voltage detective systems (VDS)" (IEC/EN 61243-5)
- Part 417 "Voltage detectors – Distance voltage detectors" (draft 08.08)
- Part 421 "Capacitive type to be used for voltages exceeding 1 kV a.c. and a frequency of 16.7 Hz" (draft 08.08)
- Part 431 "Live working – Portable phase comparators for voltages of 1 kV to 36 kV a.c." (IEC/EN 61481)
- Part 511 "Electrical insulating blankets" (IEC/EN 61112)
- Part 512 "Electrical insulating matting" (IEC/EN 61111)
- Part 513 "Live working – Flexible conductor covers (line hoses) of insulating material" (IEC/EN 61479)
- Part 551 "Rigid protective covers for live working on a.c. installations" (IEC/EN 61229)
- Part 552 "Live working – Insulating protective barriers above 1 kV"
- Part 603 "Live working – Telescopic sticks and telescopic measuring sticks" (IEC/EN 62193)
- Part 621 "Live working – Suction device for the cleaning of live parts with rated voltages above 1 kV up to 36 kV"
- Part 651 "Saddles, pole clamps (stick clamps) and accessories for live working" (IEC/EN 61236)
- Part 741 "Aerial devices with insulating boom used for live working exceeding 1 kV a.c." (IEC/EN 61057)

#### DIN VDE 0683

"Portable equipment for earthing or earthing and short-circuiting"

- Part 100 "Live working – Portable equipment for earthing or earthing and short-circuiting" (IEC/EN 61230)
- Part 200 "Live working – Earthing or earthing and short-circuiting equipment using lances as a short-circuiting device – Lance earthing" (IEC/EN 61230)

#### 1.1 Further reference:

"Arbeitsschutz in elektrischen Anlagen"  
["Occupational safety in electrical installations"]  
Explanations on DIN VDE 0105, 0680, 0681, 0682 and 0683  
VDE Series, Volume 48  
Dr. P. Hasse, W. Kathrein and H. Kehne  
VDE-Verlag GmbH, Berlin-Offenbach, Germany

"Arbeiten unter Spannung (AuS)"  
["Live working"]  
Practical Examples  
Dr. P. Hasse, W. Kathrein  
WEKA MEDIA GmbH & Co. KG, Kissing, Germany.

## 2. Abbreviations

### 2.1 Materials

Abbreviation used in our catalogue	Material
Al	Aluminium
Cu	Electric copper, copper
St	Steel
StSt	Stainless steel
MCI	Malleable cast iron
ZDC	Zinc die casting
AlMgSi	Aluminium alloy
GRP	Glass-fibre reinforced plastic

### 2.2 Coating materials

Abbreviation used in our catalogue	Coasting material
gal Sn	Tin-plated
gal Zn	Galvanised
tZn	Hot-dip galvanised
Bronze gal Sn	Bronze, tin-plated

### 2.2 Types of conductors

Abbreviation used in our catalogue	Type of conductor
Fl	Flat conductor
Rd	Round conductor

## 5. Maintenance tests



## 3. Minimum lengths of insulating elements for

- 1) Operating sticks acc. to DIN VDE 0681
- 2) Voltage detectors acc. to IEC/EN 61243-1 (DIN VDE 0682 Part 411)
- 3) Phase comparators acc. to IEC/EN 61481 (DIN VDE 0682 Part 431)

Nominal voltage	Rated voltage	Minimum length of the insulating element $L_{I \min}$		
		1)	2)	3)
$U_N^{*)}$	$U_r$	1)	2)	3)
up to 10 kV	12 kV	500 mm	520 mm	525 mm
20 kV	24 kV	500 mm	520 mm	525 mm
30 kV	36 kV	525 mm	520 mm	525 mm
45 kV	52 kV	720 mm	830 mm	—
60 kV	72.5 kV	900 mm	830 mm	—
110 kV	123 kV	1300 mm	1300 mm	—
150 kV	170 kV	1750 mm	1700 mm	—
220 kV	245 kV	2400 mm	2300 mm	—
380 kV	420 kV	3200 mm	3600 mm	—

\*) For nominal voltages higher or lower than the nominal voltage indicated in the table above, a rated voltage closest to the required nominal voltage must be selected. In extreme cases, the nominal voltage is equal to the rated voltage.

## 4. Designs

Operating sticks and equipment are basically subdivided into the following types:



### Not suitable for use in wet weather conditions

For indoor and outdoor installations

For use in indoor and outdoor installations, but not in wet weather conditions.



### Suitable for use in wet weather conditions

For indoor and outdoor installations

For use in indoor and outdoor installation, in all weather conditions (even if the operating stick gets wet).



### For indoor installations only!

### Maintenance test criteria for safety equipment

	BGV A3 (German regulation)	VDE 0105 Part 100 and EN 50110-1*)	Equipment standard
<b>Earthing and short-circuiting devices</b>	§ 5 (1) [... It shall be checked whether equipment is in good order and condition...] (2) [... at certain intervals. The intervals must be chosen so that the defects to be expected are detected in due time.]	5.3.101 Periodic inspections, general information	IEC/EN 61230, Annex C (informative), C 3.2.2 [It is recommended to perform a cut test and visual inspection at least every five years in case of outdoor use and every ten years in case of indoor use.]
<b>Voltage detectors, phase comparators and voltage detecting systems</b>	§ 5: according to table 1C [Tests for compliance with the limit values specified in the electrotechnical rules must be carried out at least every six years]	*) 6.2.3 [Inspection at least before and, if possible, after each use], 5.3.101 Periodic inspections, general information	IEC/EN 61243-1, Annex G (informative): Tests for capacitive voltage detectors > 1 kV [Voltage detectors that have not been subjected to a maintenance test within six years should not be used.]  IEC/EN 61243-5: Tests for voltage detecting systems (VDS)  IEC/EN 61481, Annex G (informative): Tests for phase comparators 1 to 36 kV a.c. [The maximum interval between maintenance tests is six years.]
<b>Operating and earthing sticks</b>	§ 5: according to table 1C [A visual inspection for signs of damage or defect must be carried out prior to each use.]	5.3.101 Periodic inspections, general information	VDE 0681 Part 1 to 3: Tests for operating sticks Note: Operating sticks also have to be subjected to electrotechnical tests. DEHN + SÖHNE recommends to use the test intervals of voltage detectors.

## Tests for our Safety Equipment

Our tried and tested safety equipment allows safe working in electrical installations. It is state of the art, complies with the German accident prevention regulations (UVV) and exceeds the requirements of national and international standards.



One of our high-voltage test laboratories

Numerous process inspections ensure the high quality and reliability of our safety equipment.

The following pictures show type tests performed on our safety equipment.



Testing a PHE III voltage detector for immunity to interference fields



Testing a switchgear installation for protection against bridging



Pull test carried out on an earthing and short-circuiting device



## Safety Equipment

## Design of Voltage Detectors

### Voltage Detectors

Voltage detectors according to IEC/EN 61243-1 (DIN VDE 0682 Part 411) are designed to verify safe isolation from supply voltage on all poles at the work location according to EN 50110-1 (DIN VDE 0105 Part 100).

Safe isolation from supply voltage must be verified on all poles at the work location or as close as possible to the work location by electrotechnically skilled or instructed persons only.

Voltage detectors must be tested for correct operation immediately before and after use. Correct operation of voltage detectors without self-testing element must be verified by contacting a part of the installation connected to operating voltage.

Verifying safe isolation from supply voltage using a voltage detector is considered live working.

Voltage detectors may only be used for the nominal voltages / nominal voltage ranges as indicated on the rating plate. The user may be at risk if they are used for voltages other than indicated on the rating plate (incorrect indication, electric shock, arcing).

Voltage detectors labelled with "For indoor use only" may only be used in indoor installations.

Voltage detectors labelled with "For use in wet weather conditions" may be used in all weather conditions (rain, snow, fog and dew).

Voltage detectors according to IEC/EN 61243-1 (DIN VDE 0682 Part 411) are only suitable to a limited extent for use in **factory assembled (type-tested) installations**. If space in installations is confined, flashover may occur when inserting the test prod into the installation. The user of the voltage detector or the operator of the switchgear installation must contact the manufacturer of the type-tested installation to find out whether the voltage detector may be used (please refer to the table on the next page: Application of voltage detectors in type-tested, factory assembled switchgear installations).

### Design of voltage detectors

Voltage detectors according to IEC/EN 61243-1 (DIN VDE 0682 Part 411) are **single-pole** devices designed to make contact with the part of the installation to be tested.

There are two **mechanically different designs** of voltage detectors: Complete and separate voltage detectors.

**Complete** voltage detectors (PHE III, PHE and PHG II) consist of an insulating stick, indicator and test prod and are tested as a complete unit.

**Separate** voltage detectors (PHE III indicator with test prod) must be attached to a suitably rated insulating stick.

Single-pole **voltage detectors** typically consist of a **handle, insulating element, indicator and test prod with contact electrode**.

The **insulating element** is the section of a voltage detector between the hand guard and the red ring. It ensures that the user maintains an adequate safety distance for safe operation.

The **test prod** (contact electrode extension) with contact electrode **above the red ring** allows to reach remote parts of the installation and to **eliminate** the influences of **interference fields**.

Voltage detectors are classified into two categories based on their behaviour in case of interference fields or their field of application. Voltage detectors of **category "L"** (line) with a short test prod (without contact electrode extension) are designed for use on overhead lines.

Voltage detector of **category "S"** (switchgear) with a long test prod (with contact electrode extension) are resistant to interference fields and are therefore used in switchgear installations. They are also suitable for overhead lines.

The **hand guard** provides a visible barrier between the handle and the insulating element and prevents the user from making contact with the insulating element.

The **red ring** indicates the end of the insulating element in the direction of the test electrode. This provides the user with a visible limit for contact with live parts in the installation. The **insulating element** between the red ring and the hand guard must not contact live parts, however, it may contact earthed parts.

The **test electrode** is the part of the voltage detector that is used to make contact with the part of the installation to be tested.

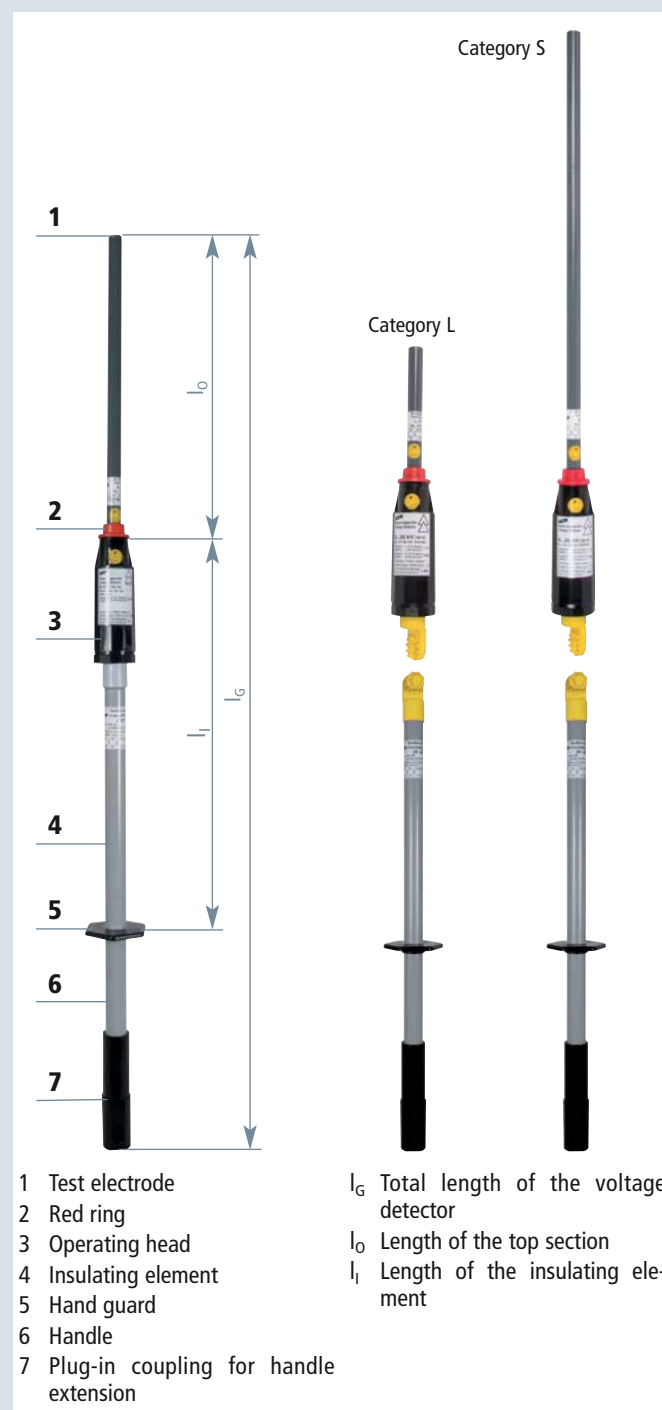

**Application of Voltage Detectors**

Safety Equipment

**in type-tested, factory assembled switchgear installations**

Voltage Detectors

Tests carried out in cooperation with switchgear manufacturers have proven the suitability of PHE, PHE III and PHG II voltage detectors (Category "S") for use in factory assembled switchgear installations

(e.g. in accordance with EN/IEC 62271-200 (DIN VDE 0670 or DIN VDE 0671 Part 200)).

Switchgear manufacturer	Type	Nominal voltages U <sub>N</sub>	Suitable voltage detectors
ABB	BA/BB systems, BAX systems, BD systems BC systems	10 ... 30 kV	PHE, PHE III and PHG II  PHE, PHE III and PHG II
ABB Calor Emag	ZE3/4, ZE7/8, ZK4/5, ZK8 L7.6, ZS1, ZS8 ZW1 Isopond	10 ... 30 kV  10 kV	PHE, PHE III and PHG II PHE and PHE III PHE, PHE III with test probe, Part No. 766 916
AREVA T&D			
AEG	GS, GSD, GSH, H, K, L	10 ... 20 kV	PHE, PHE III and PHG II
Concordia Sprecher + Schuh	PI, PIC, PID, PN 300, PN 500, PN 600, PU, PUADC, PUB, PUD, PUDC, SC, SCC, SCD, SCDC, RMB <sup>1)</sup>	10 ... 30 kV	PHE, PHE III and PHG II
Sachsenwerk	A (HA, MA, SM), FK (A, B, C, E, F), PIX, R (D <sup>1)</sup> , L, LI, M <sup>1)</sup> , MI <sup>1)</sup> , W (AK, BA, BB, BD, DS), WK (A, B, C, D, E, F, M, T), WZ (K, R, RV)	6 ... 30 kV	PHE, PHE III and PHG II
Starkstromanlagen Dresden	D, WKC-D	10 kV	PHE, PHE III and PHG II
VEB Otto Buchwitz	BSIG, CSIM	20 kV	PHE, PHE III and PHG II
BELUK	BET2308, BET231, BK219, BK216, BMB2, BRS; Compact load-break switchgear installations	20 kV	PHE, PHE III and PHG II  PHE, PHE III
Driescher Moosburg	W12, W24, W36, WEL, F24 E2K, E3K, D12, D24; Compact load-break switchgear installations	12 ... 36 kV 12 ... 24 kV	PHE, PHE III und PHG II PHE, PHE III with great insertion depth (e.g. Part No. 767 731)
Driescher Wegberg	Mipak, Minor, Minex, RKL, ZLDT, TSL, TSLG, FL, SK400, BS600, HS24, LDTC	10 ... 20 kV	PHE, PHE III and PHG II or PHE III with test prod, Part No. 767 767 for type Mipak
Eaton Holec	HC, Unitole Magnefix MMS, SVS, Xiria	3 ... 24 kV 3 ... 15 kV 3 ... 24 kV	PHE and PHE III with electrode, Part No. 766 927 PHE and PHE III with electrode, Part No. 766 915 PHE and PHE III with electrode, Part No. 766 913 or 766 925
Eimers	EKS 10 N, ES 20 N, ES 10 N, EMS 12.190	10 ... 20 kV	PHE, PHE III and PHG II
ORMAZABAL (F & G)	HGKN, EA, MA, KE, EF, WA, K-HGK	10 ... 20 kV	PHE, PHE III and PHG II
Pfisterer	MAG	10 kV	PHE with test prod P2/10
Klöpffer	KMG	10 ... 20 kV	PHE, PHE III and PHG II
Krone	KH10, KHS10d, KHS10dp, KHS17I, KHS17II, KHS20, KHS30 KES10	10 ... 30 kV	PHE, PHE III and PHG II  PHE, PHE III with test probe, Part No. 766 916
Miebach	AS, HUK, TE, TSE, DSS, ASR	10 ... 20 kV	PHE, PHE III and PHG II
NATUS	NES, NESCON, NFwZ	3 ... 20 kV	PHE, PHE III and PHG II
Ritter	GT1, GT3	6 ... 30 kV	PHE, PHE III and PHG II
Senteg	AMS12	3 ... 10 kV	PHE, PHE III and PHG II
Siemens	8 BD, 8 CK	6 ... 30 kV	PHE, PHE III with modified contact electrode (on request)
The circuit breaker must be tripped before testing systems containing a circuit breaker	8 BK 20, 8 BJ 20, 8 BK 30, 8 AA 10	6 ... 20 kV	PHE, PHE III and PHG II
Wickmann	DZ switchgear cabinet	20 kV	PHE, PHE III and PHG II
Ziegler	AZ cells	10 ... 20 kV	PHE, PHE III and PHG II

<sup>1)</sup> Switchgear panels with integrated division into busbar or cable compartments require special guide adapters for the fixed isolating contacts.

## Safety Equipment

## Selection Guide

## Voltage Detectors

Device	Nominal Voltage $U_N$ / Frequency $f_N$	Application, Indication	Page
PHE III and PHE III indicator with test prod	3 / 6 / 10 / 20 / 30 kV / 50 Hz 3...10 / 6...20 / 10...30 kV / 50 Hz 3...10 / 10...30 kV / 50 Hz, switchable 6...20 / 10...30 kV / 50 Hz, test set	For use in wet weather conditions For indoor and outdoor installations With self-testing element Visual and acoustic indicator	12 16
PHE III (Kit)	20 kV / 50 Hz 60...110 und 60...132 kV / 50 Hz	Easy transport Fast battery replacement without additional tools	18
PHE	3 / 6 / 10 / 20 / 30 kV / 50 Hz 3...10 / 6...20 / 15...30 kV / 50 Hz 3...10 / 6...20 / 15...30 kV / 50 Hz switchable	For use in wet weather conditions For indoor and outdoor installations With self-testing element Visual indicator Easy transport	24
ASP HSA 205	110...420 kV / 50 Hz 1...30 / 30...220 / 110...420 kV	For use in wet weather conditions Non-contact voltage detector For overhead lines and outdoor switching stations With self-testing element Visual and acoustic indicator	26
PHG II	6 / 10 / 20 kV / 50 Hz	For indoor installations only Three LED indicator lights LEDs staggered at 120° allow for better visibility of the indication Passive voltage detector without batteries	28
PHE/G	1...24 kV / d.c. voltage	For use in wet weather conditions For indoor and outdoor installations With self-testing element Visual indicator Easy transport Two-pole unit (one stick/two sticks)	29
Storage Bags and Transport Cases		Sheet metal or plastic case Artificial leather or canvas bag	187

## Maintenance tests

According to German regulations (BGV A3), voltage detectors have to be tested for compliance with the prescribed limits as stated in the Electrical Safety Rules. This test is performed in the high voltage test laboratory of DEHN + SÖHNE and includes

- measurement of the leakage current,
- test for clear indication,
- test for protection against bridging,
- visual inspection, manual tests and measurements.

This maintenance test is documented in a test report and on the device.

The test intervals depend on the operating conditions of the voltage detector, e.g. frequency of use, environmental conditions and transport. According to German regulations, however, it is advisable to carry out a maintenance test **at least every 6 years**.





## PHE III M12 Voltage Detector

Safety Equipment

Nominal voltages up to 30 kV / 50 Hz

Voltage Detectors



Safe verification of isolation from supply voltage

- Reliable indication
- Easy to use
- Cost-effective/space-saving transport



PHE III voltage detector with visual and acoustic indicator used for an indoor switchgear installation

### General Information:

Standard	EN/IEC 61243-1 (DIN VDE 0682 Part 411)
Temperature range	– 25 °C ... + 55 °C, climatic category N
Design	Complete
Use	Suitable for use in wet weather conditions
For	Indoor and outdoor installations
Indication	Visual and acoustic
Self-testing element	Yes
Material (test electrode)	Copper alloy/gal Sn
Material (test prod)	Glass-fibre reinforced epoxy resin tube
Material (indicator)	Plastic, fully insulated
Material (insulating stick)	Glass-fibre reinforced polyester tube



Testing with integrated electrode



Testing with screwed-on V-shaped electrode



Plugging a HV STK extension handle into an IS PHE STK insulating stick

## Safety Equipment

## PHE III M12 Voltage Detector

## Voltage Detectors

Nominal Voltages up to 30 kV / 50 Hz

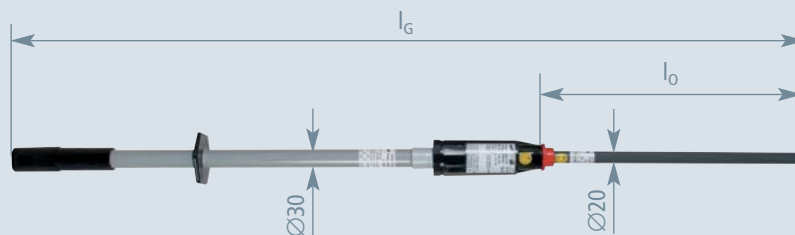

Category "S"

Type	PHE3 3 S	PHE3 6 S	PHE3 10 S	PHE3 20 S	PHE3 30 S
Part No.	767 703	767 706	767 710	767 720	767 730
Nominal voltage (U <sub>N</sub> )	3 kV	6 kV	10 kV	20 kV	30 kV
Total length (l <sub>G</sub> )	1080 mm	1080 mm	1080 mm	1230 mm	1415 mm
Insertion depth (l <sub>o</sub> )	285 mm	285 mm	285 mm	435 mm	620 mm

Type	PHE3 3 10 S	PHE3 6 20 S	PHE3 10 30 S
Part No.	767 711	767 721	767 731
Nominal voltage (U <sub>N</sub> )	3 ... 10 kV	6 ... 20 kV	10 ... 30 kV
Total length (l <sub>G</sub> )	1415 mm	1575 mm	1675 mm
Insertion depth (l <sub>o</sub> )	620 mm	780 mm	880 mm

## Nominal Voltage Ranges up to 30 kV / 50 Hz, switchable

The nominal voltage selector switch allows to switch between two nominal voltage ranges. For safety reasons, the voltage detector can only be switched on if the selector switch is switched to the most sensitive range of 3 kV to 10 kV. The switch snaps into the relevant position, thus providing protection against inadvertent switching. A magnetically operated, wear-resistant reed switch changes the switching position.

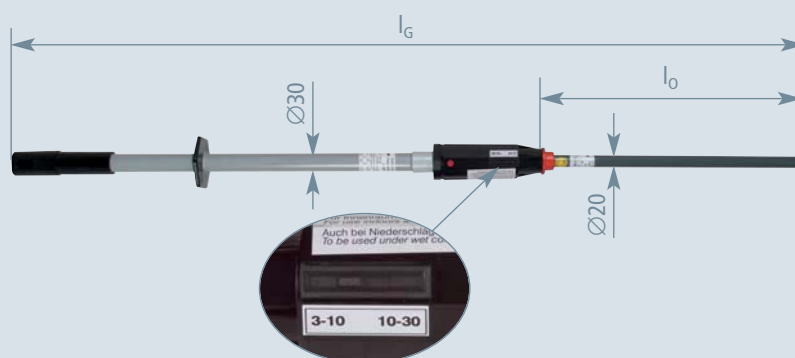

Category "S"

Type	PHE3 U 3 30 S
Part No.	767 733
Nominal voltage (U <sub>N</sub> )	3 ... 10 / 10 ... 30 kV
Total length (l <sub>G</sub> )	1675 mm
Insertion depth (l <sub>o</sub> )	880 mm

## Nominal Voltage Ranges up to 30 kV / 50 Hz, Test Set

The test set includes two test prods of different lengths which are labelled "S" (long test prod) and "L" (short test prod) on the rating plate.

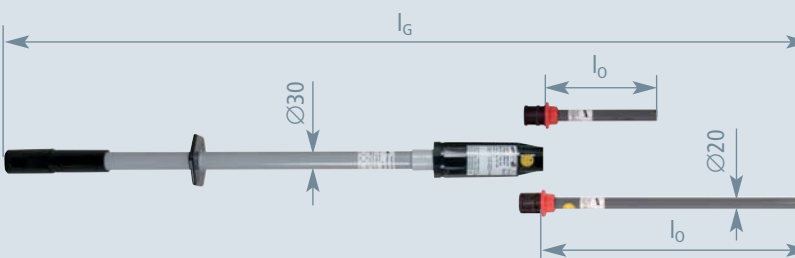

Category "S" and "L"

Type	PHE3 6 20 SL	PHE3 10 30 SL
Part No.	767 740	767 750
Nominal voltage (U <sub>N</sub> )	6 ... 20 kV	10 ... 30 kV
Total length (l <sub>G</sub> )	1575 / 990 mm	1675 / 990 mm
Insertion depth (l <sub>o</sub> )	780 / 185 mm	880 / 185 mm

Voltage detectors for other nominal voltages and frequencies are available on request.

## PHE III ZK Voltage Detector

Safety Equipment

Nominal voltages up to 30 kV / 50 Hz

Voltage Detectors



PHE III ZK voltage detector used in an indoor switchgear installation

Safe verification of isolation from supply voltage

- Reliable indication
- Easy to use
- Cost-effective/space-saving transport



### General Information:

Standard	EN/IEC 61243-1 (DIN VDE 0682 Part 411)
Temperature range	- 25 °C ... + 55 °C, climatic category N
Design	Complete
Use	Suitable for use in wet weather conditions
For	Indoor and outdoor installations
Indication	Visual and acoustic
Self-testing element	Yes
Material (test electrode)	Copper alloy/gal Sn
Material (test prod)	Glass-fibre reinforced epoxy resin tube
Material (indicator)	Plastic, fully insulated
Material (insulating stick)	Glass-fibre reinforced polyester tube

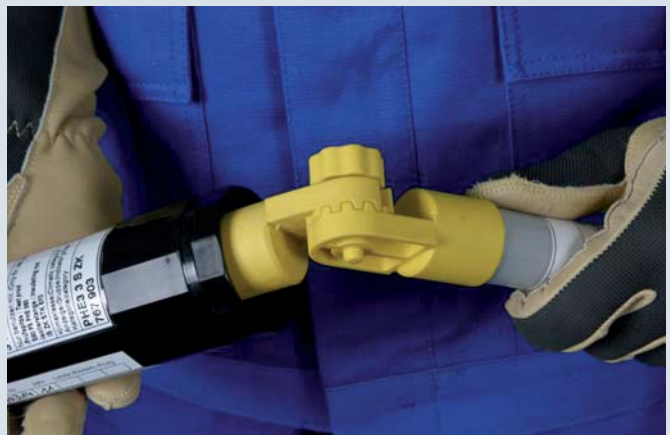
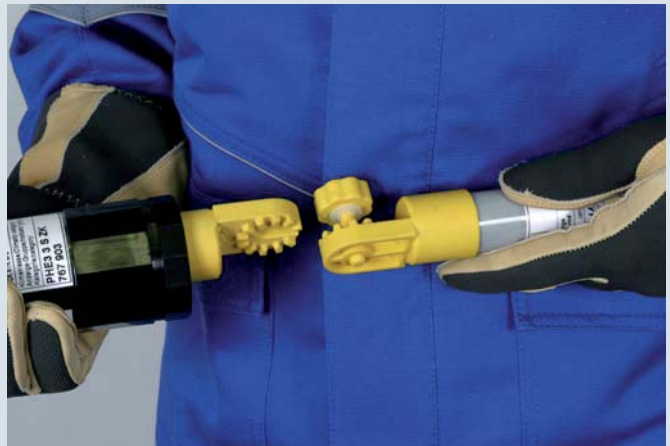

Universal gear coupling allows to adjust the angle of the voltage detector



## Safety Equipment

## PHE III ZK Voltage Detector

## Voltage Detectors

Nominal Voltages up to 30 kV / 50 Hz

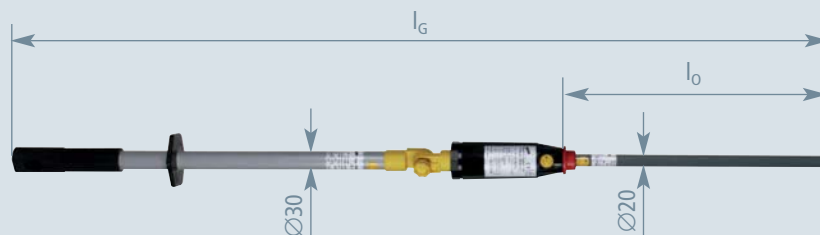

Category "S"

Type	PHE3 3 S ZK	PHE3 6 S ZK	PHE3 10 S ZK	PHE3 20 S ZK	PHE3 30 S ZK
Part No.	767 903	767 906	767 910	767 920	767 930
Nominal voltage (U <sub>N</sub> )	3 kV	6 kV	10 kV	20 kV	30 kV
Total length (l <sub>G</sub> )	1150 mm	1150 mm	1150 mm	1300 mm	1485 mm
Insertion depth (l <sub>o</sub> )	285 mm	285 mm	285 mm	435 mm	620 mm

Type	PHE3 3 10 S ZK	PHE3 6 20 S ZK	PHE3 10 30 S ZK
Part No.	767 941	767 951	767 961
Nominal voltage (U <sub>N</sub> )	3 ... 10 kV	6 ... 20 kV	10 ... 30 kV
Total length (l <sub>G</sub> )	1485 mm	1645 mm	1745 mm
Insertion depth (l <sub>o</sub> )	620 mm	780 mm	880 mm

## Nominal Voltage Ranges up to 30 kV / 50 Hz, switchable

The nominal voltage selector switch allows to switch between two nominal voltage ranges. For safety reasons, the voltage detector can only be switched on if the selector switch is switched to the most sensitive range of 3 kV to 10 kV. The switch snaps into the relevant position and provides protection against inadvertent switching. A magnetically operated, wear-resistant reed switch changes the switching position.

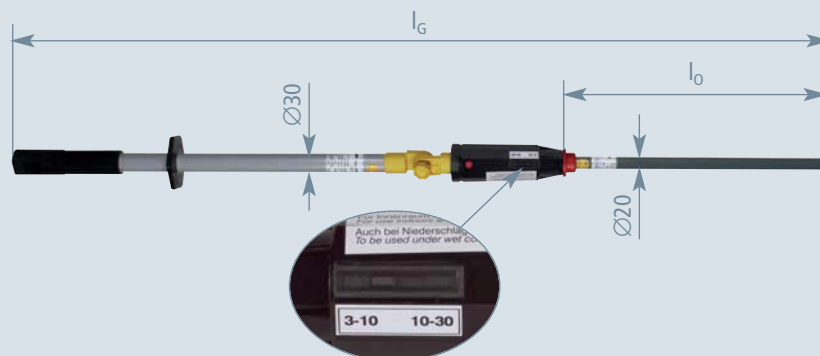

Category "S"

Type	PHE3 U 3 30 S ZK
Part No.	767 960
Nominal voltage (U <sub>N</sub> )	3 ... 10 / 10 ... 30 kV
Total length (l <sub>G</sub> )	1745 mm
Insertion depth (l <sub>o</sub> )	880 mm

## Nominal Voltage Ranges up to 30 kV / 50 Hz, Test Set

The test set includes two test prods of different lengths which are marked "S" (long test prod) and "L" (short test prod) on the rating plate.

Category "S" and "L"

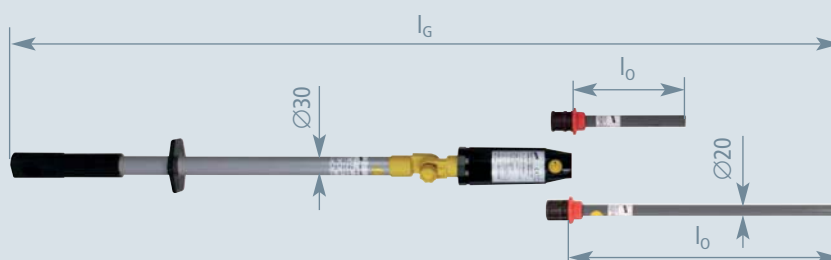

Type	PHE3 6 20 SL ZK	PHE3 10 30 SL ZK
Part No.	767 940	767 950
Nominal voltage (U <sub>N</sub> )	6 ... 20 kV	10 ... 30 kV
Total length (l <sub>G</sub> )	1650 / 1050 mm	1750 / 1050 mm
Insertion depth (l <sub>o</sub> )	780 / 185 mm	880 / 185 mm

Voltage detectors for other nominal voltages and frequencies are available on request.

## PHE III ZK Indicator with Test Prod

Safety Equipment

Nominal voltages up to 30 kV / 50 Hz

Voltage Detectors



PHE III indicator with test prod, universal gear coupling and insulating stick

### General Information:

Standard (indicator with test prod)	EN/IEC 61243-1 (DIN VDE 0682 Part 411)
Standard (universal gear coupling)	EN/IEC 60832 (DIN VDE 0682 Part 211)
Temperature range	– 25 °C ... + 55 °C, climatic category N
Design	Separate
Use	Suitable for use in wet weather conditions
For	Indoor and outdoor installations
Indication	Visual and acoustic
Self-testing element	Yes
Material (test electrode)	Copper alloy/gal Sn
Material (test prod)	Glass-fibre reinforced epoxy resin tube
Material (indicator)	Plastic, fully insulated

### Standby function

The PHE III indicator with test prod has a standby function that automatically activates the device as soon as contact with energised equipment is made (without previous self-test) and visually and acoustically indicates "voltage present". When making contact with de-energised equipment, the indicator is not activated.

### Attention

The PHE III indicator with test prod may only be used in combination with a suitably rated insulating stick from the same equipment range.

Safe verification of isolation from supply voltage

- Reliable indication with standby function
- Easy to use
- Cost-effective/space-saving transport

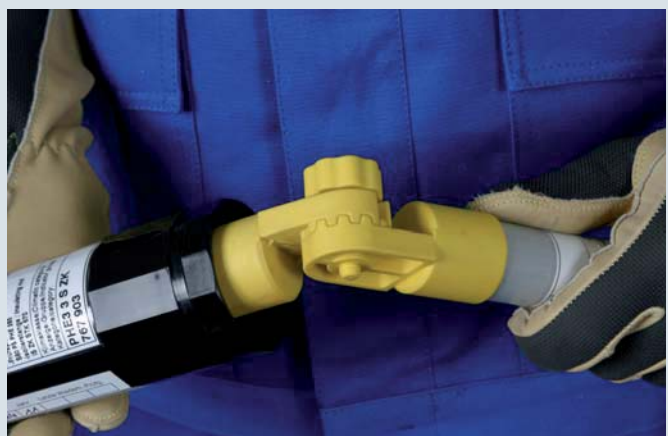
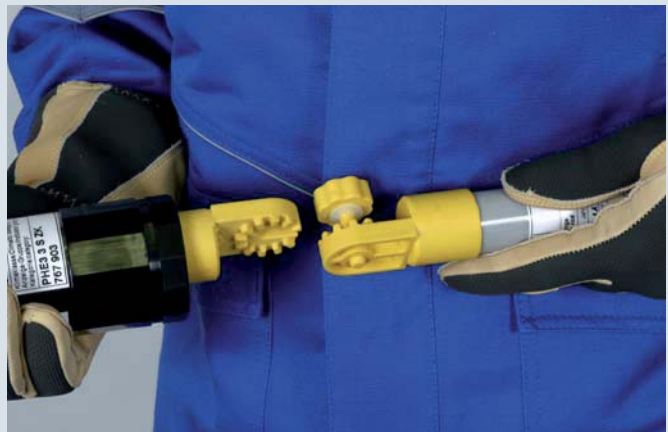

Universal gear coupling allows to adjust the angle of the voltage detector

## Safety Equipment

## PHE III ZK Indicator with Test Prod

## Voltage Detectors

## Nominal Voltage Ranges up to 30 kV / 50 Hz, Category "S"

Category "S"

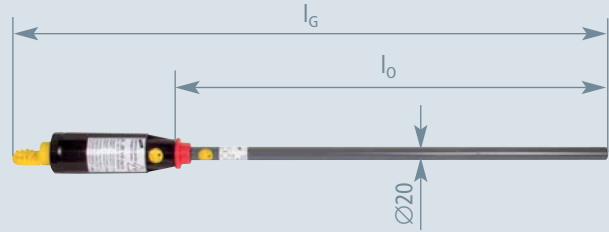

Type	PHE3 PK6 20 S SB ZK	PHE3 PK10 30 S SB ZK
Part No.	767 921	767 931
Nominal voltage ( $U_N$ )	6 ... 20 kV	10 ... 30 kV
Total length ( $l_G$ )	1010 mm	1110 mm
Insertion depth ( $l_o$ )	780 mm	880 mm

## Nominal Voltage Ranges up to 30 kV / 50 Hz, Category "L"

Category "L"

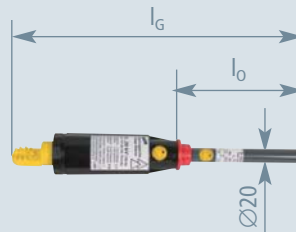

Type	PHE3 PK6 20 L SB ZK	PHE3 PK10 30 L SB ZK
Part No.	767 922	767 932
Nominal voltage ( $U_N$ )	6 ... 20 kV	10 ... 30 kV
Total length ( $l_G$ )	415 mm	415 mm
Insertion depth ( $l_o$ )	185 mm	185 mm

Voltage detectors for other nominal voltages and frequencies as well as indicators with permanent light and acoustic signal instead of flashing light and intermittent acoustic signal are available on request.

## Accessory for PHE III ZK Indicator with Test Prod

## Insulating Stick with universal Gear Coupling

Type	IS ZK STK 670
Part No.	766 368
Nominal voltage ( $U_N$ )	Up to 36 kV
Total length ( $l_G$ )	670 mm
Material	Glass-fibre reinforced polyester tube

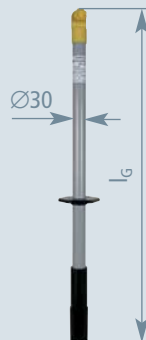

## Accessory for PHE III ZK Indicator with Test Prod

## Telescopic Insulating Stick

With scale for measuring the ground clearance, mounted support included

Type	ISMTC N 36 ZK 10600
Part No.	766 037
Nominal voltage ( $U_N$ )	Up to 36 kV
Total length ( $l_{G \max} / l_{G \min}$ )	10,600 / 1750 mm
Material	Glass-fibre reinforced epoxy resin tube
End fitting	Non-slip plastic cap



**PHE III ZK Voltage Detector Kit**

Safety Equipment

Nominal voltage 20 kV / 50 Hz

Voltage Detectors

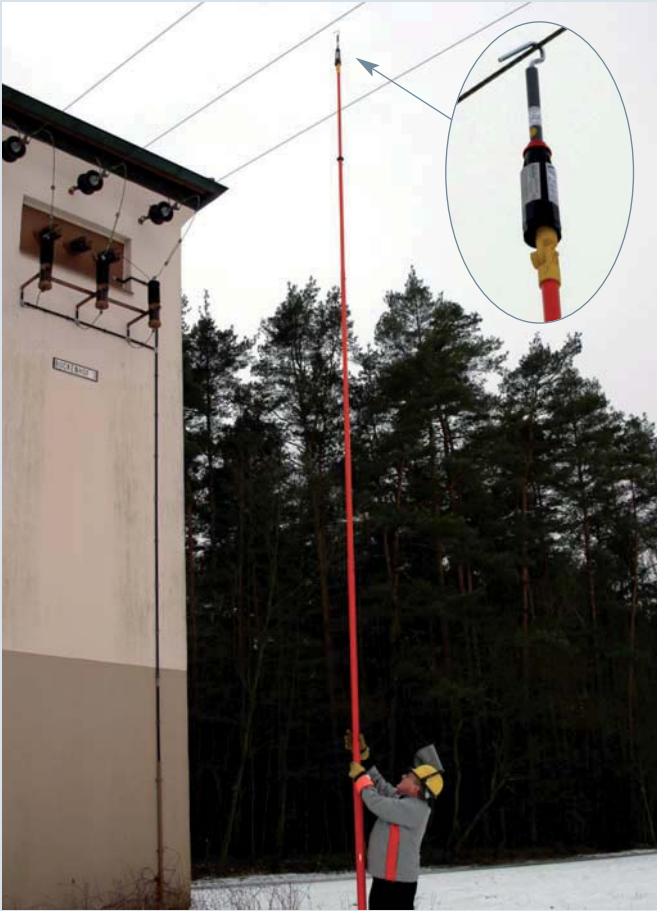

PHE III voltage detector with telescopic insulating stick

**Safe verification of isolation from supply voltage**

- Reliable indication
- Easy to use
- Multi-purpose kit
- Cost-effective/space-saving transport

**General Information:**

Standard (indicator with test prod)	EN/IEC 61243-1 (DIN VDE 0682 Part 411)
Standard (universal gear coupling)	EN/IEC 60832 (DIN VDE 0682 Part 211)
Temperature range	– 25 °C ... + 55 °C, climatic category N
Design	Complete
Use	Suitable for use in wet weather conditions
For	Indoor and outdoor installations
Type	Telescopic insulating stick (10.6 m)
Indication	Visual and acoustic
Self-testing element	Yes
Material (test electrode)	Copper alloy/gal Sn
Material (test prod)	Glass-fibre reinforced epoxy resin tube
Material (indicator)	Plastic, fully insulated
Material (insulating stick)	Glass-fibre reinforced polyester tube
Material (telescopic insulating stick)	Glass-fibre reinforced epoxy resin tube
End fitting (insulating stick)	Plug-in coupling for extending the handle
End fitting (telescopic insulating stick)	Non-slip plastic cap

**Kit includes:**

Pos. No.	Part No.	Pos. No.	Part No.
<b>1</b>	766 927	<b>8</b>	766 037
<b>2</b>	766 923	<b>9</b>	766 335
<b>3</b>	766 960	<b>10</b>	766 049
<b>4</b>	767 763	<b>11</b>	767 996
<b>5</b>	767 766	<b>12</b>	766 036
<b>6</b>	767 722	<b>13</b>	766 039
<b>7</b>	766 368		

For more detailed information on these products, see Accessory chapter

Safety Equipment

PHE III ZK Voltage Detector Kit

Voltage Detectors

Nominal Voltage 20 kV / 50 Hz, Category "S"

The diagram shows the components of the PHE III ZK Voltage Detector Kit 'S'. It includes a main detector (1), a secondary detector (3), a probe (4), a connector (6), a sleeve (7), a handle (9), and a carrying case (11). Dimensions are indicated:  $l_{G \text{ max}}$  for the total length,  $l_{o \text{ max}}$  for the insertion depth, and diameters  $\varnothing 30$ ,  $\varnothing 20$ , and  $\varnothing 20$ .

Possible lengths:		
Length $l_G$	Insertion depth $l_o$	No.
3080 mm	1600 mm	3+4+6+7+9
2290 mm	800 mm	1+4+6+7+9
1660 mm	800 mm	1+4+6+7

Type	PHE3S 20 S ZK
Part No.	767 724
Nominal voltage ( $U_N$ )	20 kV
Total length ( $l_G$ )	3080 mm
Insertion depth ( $l_o$ )	1600 mm

Category "S"

Nominal Voltage 20 kV / 50 Hz, Category "L"

The diagram shows the components of the PHE III ZK Voltage Detector Kit 'L'. It includes a main detector (8), a secondary detector (10), a probe (5), a connector (6), a sleeve (2), and a carrying case (12). Dimensions are indicated:  $l_{G \text{ max}} / l_{G \text{ min}} (5 + 6 + 8)$  for the total length,  $\varnothing 63$  for the main detector diameter,  $\varnothing 27$  for the sleeve diameter, and  $l_o$  for the insertion depth.

Type	PHE3S 20 L ZK
Part No.	767 725
Nominal voltage ( $U_N$ )	20 kV
Total length ( $l_G$ )	11000 / 2150 mm
Insertion depth ( $l_o$ )	190 mm

Category "L"

Voltage detectors for other nominal voltages and frequencies as well as indicators with permanent light and acoustic signal instead of flashing light and intermittent acoustic signal are available on request.



**PHE III M12 / ZK Voltage Detector Kit**

Safety Equipment

Nominal voltage 10 ... 132 kV / 50 Hz

Voltage Detectors



PHE III voltage detector used on a 110 kV outdoor station

**General Information:**

Standard	EN/IEC 61243-1 (DIN VDE 0682 Part 411)
Temperature range	– 25 °C ... + 55 °C, climatic category N
Design	Complete
Use	Suitable for use in wet weather conditions
For	Indoor and outdoor installations
Indication	Visual and acoustic
Self-testing element	Yes
Material (test electrode)	Copper alloy/gal Sn
Material (test prod)	Glass-fibre reinforced epoxy resin tube
Material (indicator)	Plastic, fully insulated
Material (insulating stick)	Glass-fibre reinforced polyester tube

**Safe verification of isolation from supply voltage**

- Reliable indication
- Easy to use
- Multi-purpose kit
- Cost-effective/space-saving transport

**Kit includes:**

Pos. No.	Part No.	Pos. No.	Part No.
<b>1</b>	766 924	<b>13</b>	767 965
<b>2</b>	766 923	<b>14</b>	766 352
<b>3</b>	767 771	<b>15</b>	766 359
<b>4</b>	767 772	<b>16</b>	766 358
<b>5</b>	767 764	<b>17</b>	766 114
<b>6</b>	767 972	<b>18</b>	766 115
<b>7</b>	767 974	<b>19</b>	766 128
<b>8</b>	767 734	<b>20</b>	766 120
<b>9</b>	767 726	<b>21</b>	766 889
<b>10</b>	767 732	<b>22</b>	766 996
<b>11</b>	767 735	<b>23</b>	766 998
<b>12</b>	767 963		

For more detailed information on these products,  
see Accessory chapter

Safety Equipment

**PHE III M12 / ZK Voltage Detector Kit**

Voltage Detectors

Nominal Voltage Range 30 ... 60 kV / 50 Hz, Category "S"

Category "S"

Kit includes:		
Type	Part No.	No.
PHE3 30 60 S	767 971	1+3+6+17+20+21
KLT 133 34 10	766 996	22

Type	PHE3S 30 60 S
Part No.	767 970
Nominal voltage (U <sub>N</sub> )	30 ... 60 kV
Total length (l <sub>G</sub> )	2530 mm
Insertion depth (l <sub>o</sub> )	880 mm

Nominal Voltage Range 30 ... 60 kV / 50 Hz, Category "L"

Category "L"

Kit includes:		
Type	Part No.	No.
PHE3 30 60 L	767 973	2+4+7+17+20+21
KLT 133 34 10	766 996	22

Type	PHE3S 30 60 L
Part No.	767 975
Nominal voltage (U <sub>N</sub> )	30 ... 60 kV
Total length (l <sub>G</sub> )	2030 mm
Insertion depth (l <sub>o</sub> )	380 mm

Nominal Voltage Range 60 ... 110 kV / 50 Hz, Category "S"

Category "S"

Kit includes:		
Type	Part No.	No.
PHE3 60 110 S	767 990	1+3+8+18+20+21
KKL PHE3 60 110	766 998	23

Type	PHE3S2 60 110 S
Part No.	767 980
Nominal voltage (U <sub>N</sub> )	60 ... 110 kV
Total length (l <sub>G</sub> )	2980 mm
Insertion depth (l <sub>o</sub> )	880 mm

## PHE III M12 / ZK Voltage Detector Kit

Safety Equipment

Nominal Voltage Range 60 ... 110 kV / 50 Hz, Category "L"

Voltage Detectors

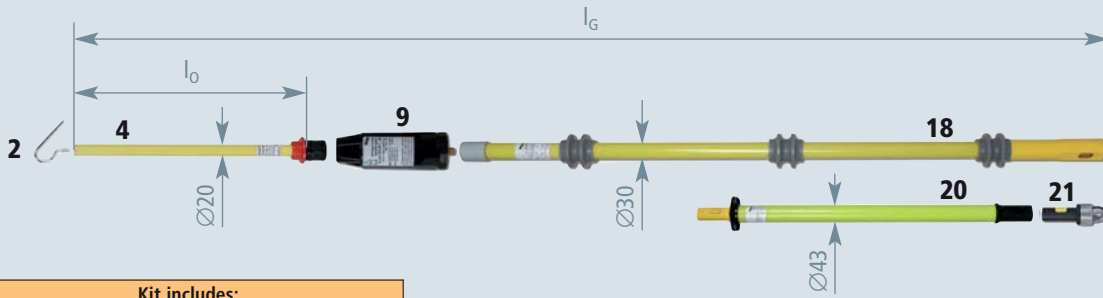

Kit includes:		
Type	Part No.	No.
PHE3 60 110 L	767 991	2+4+9+18+20+21
KKL PHE3 60 110	766 998	23

Category "L"

Type	PHE3S2 60 110 L
Part No.	767 981
Nominal voltage ( $U_N$ )	60 ... 110 kV
Total length ( $l_G$ )	2540 mm
Insertion depth ( $l_0$ )	380 mm



## Nominal Voltage Range 60 ... 132 kV / 50 Hz, Category "S / L"

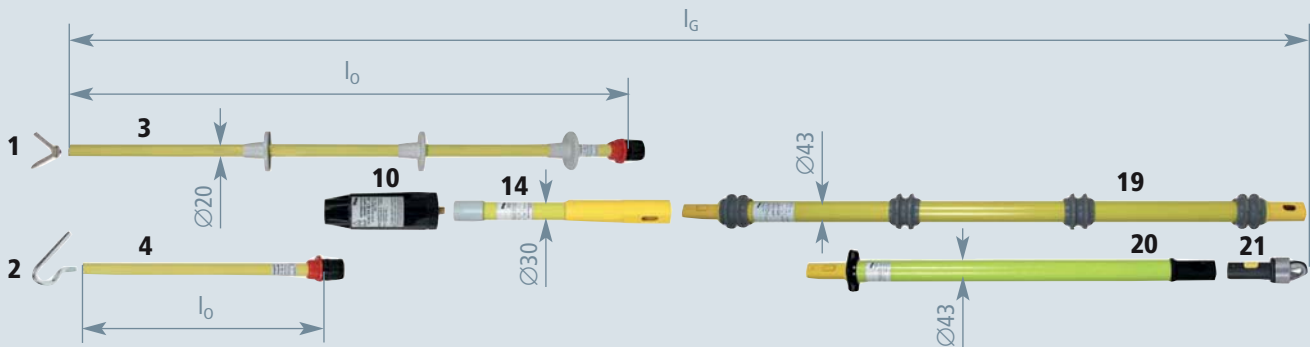

Kit includes:		
Type	Part No.	No.
PHE3 60 132 SL	767 992	1+3+2+4+10+14+19+20+21
KLT 133 34 10	766 996	22

The test set includes two test prods of different lengths which are labelled "S" (long test prod) and "L" (short test prod) on the rating plate.

Category "S" and "L"

Type	PHE3S2 60 132 SL
Part No.	767 982
Nominal voltage ( $U_N$ )	60 ... 132 kV
Total length ( $l_G$ )	3440 / 2950 mm
Insertion depth ( $l_0$ )	880 / 380 mm



## Safety Equipment

## PHE III M12 / ZK Voltage Detector Kit

## Voltage Detectors

## Nominal Voltage Range 60 ... 132 kV / 50 Hz with Gear Coupling, Category "S / L"

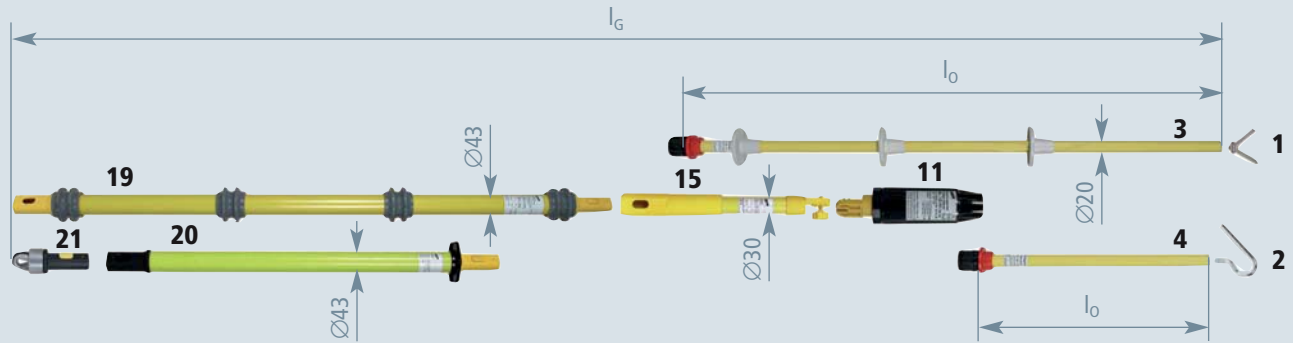

The test set includes two test prods of different lengths which are labelled "S" (long test prod) and "L" (short test prod) on the rating plate.

Category "S" and "L"

Kit includes:		
Type	Part No.	No.
PHE3 60 132 SL ZK	767 993	1+3+2+4+11+15+19+20+21
KLT 133 34 10	766 996	22

Type	PHE3S2 60 132 SL ZK
Part No.	767 983
Nominal voltage (U <sub>N</sub> )	60 ... 132 kV
Total length (l <sub>G</sub> )	3490 / 3000 mm
Insertion depth (l <sub>o</sub> )	880 / 380 mm

## Nominal Voltage Range 10 ... 30 kV / 50 Hz and 60 ... 110 kV / 50 Hz, Category "S"

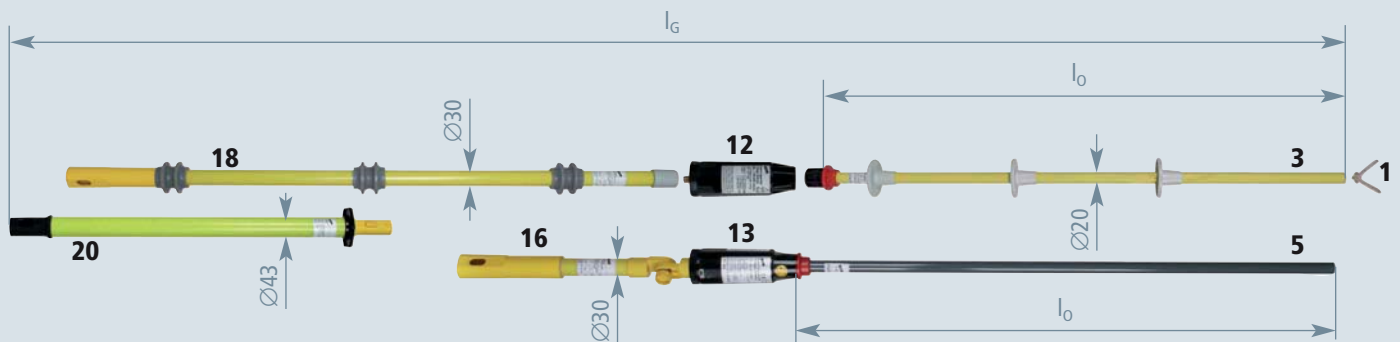

Category "S"

Kit includes:		
Type	Part No.	No.
PHE3 60 110 S IT	767 962	1+3+12+18
PHE3 10 30 S ZK30	767 964	5+13+16
H STK 43 800	766 120	20
KLT 133 34 10	766 996	22

Type	PHE3S 10 110 S
Part No.	767 984
Nominal voltage (U <sub>N</sub> )	10 ... 30 / 60 ... 110 kV
Total length (l <sub>G</sub> )	2160 / 2910 mm
Insertion depth (l <sub>o</sub> )	880 / 880 mm

Voltage detectors for other nominal voltages and frequencies as well as indicators with permanent light and continuous acoustic signal instead of flashing light and intermittent acoustic signal are available on request.

## PHE Voltage Detector

Safety Equipment

Nominal voltages up to 30 kV / 50 Hz

Voltage Detectors



PHE voltage detector with visual indication

Easy and safe testing

- Reliable indication
- Easy to use



### General Information:

Standard	EN/IEC 61243-1 (DIN VDE 0682 Part 411)
Temperature range	- 25 °C ... + 55 °C, climatic category N
Design	Complete
Use	Suitable for use in wet weather conditions
For	Indoor and outdoor installations
Indication	Visual
Self-testing element	Yes
Material (test electrode)	Copper alloy/gal Sn
Material (test prod)	Glass-fibre reinforced epoxy resin tube
Material (indicator)	Plastic, fully insulated
Material (insulating stick)	Glass-fibre reinforced polyester tube



Before testing the installation for safe isolation from supply voltage, the voltage detector must be tested for correct operation. When pressing the "TEST" button, the red indicator light flashes.



As soon as the button is released, the green indicator light lights up. The test for correct operation was successful and the voltage detector is operational.



## Safety Equipment

## PHE Voltage Detector

## Voltage Detectors

## Nominal Voltages up to 30 kV / 50 Hz

Category "S"

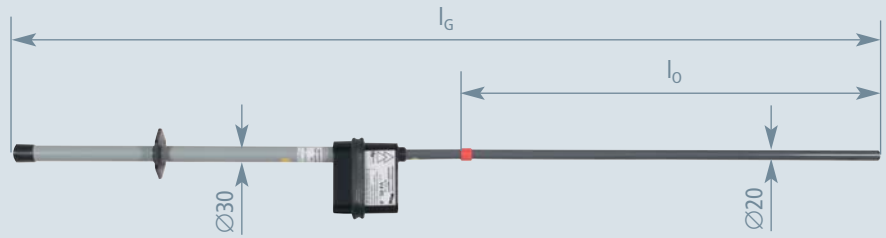

Type	PHE 3 S	PHE 6 S	PHE 10 S	PHE 20 S	PHE 30 S
Part No.	767 403	767 406	767 418	767 428	767 438
Nominal voltage (U <sub>N</sub> )	3 kV	6 kV	10 kV	20 kV	30 kV
Total length (l <sub>G</sub> )	1115 mm	1115 mm	1115 mm	1300 mm	1460 mm
Insertion depth (l <sub>o</sub> )	320 mm	320 mm	320 mm	505 mm	670 mm

Type	PHE 3 10 S	PHE 6 20 S	PHE 15 30 S
Part No.	767 410	767 420	767 430
Nominal voltage (U <sub>N</sub> )	3 ... 10 kV	6 ... 20 kV	15 ... 30 kV
Total length (l <sub>G</sub> )	1375 mm	1565 mm	1565 mm
Insertion depth (l <sub>o</sub> )	580 mm	770 mm	770 mm

## Nominal Voltage Ranges up to 30 kV / 50 Hz, switchable

The nominal voltage selector switch allows to switch between three voltage ranges. For safety reasons, the voltage detector can only be switched on if the selector switch is switched to the most sensitive range of 3 kV to 10 kV. The switch snaps into the relevant position and provides protection against inadvertent switching. A magnetically operated, wear-resistant reed switch changes the switching position.

Kategorie "S"

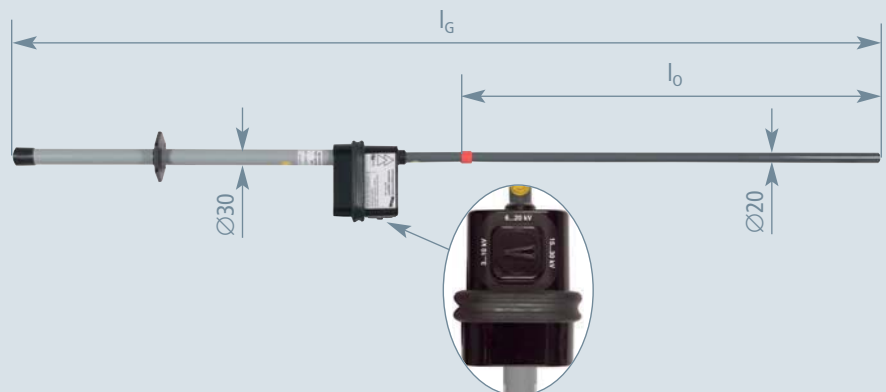

Type	PHE U 3 30 S
Part No.	767 433
Nominal voltage (U <sub>N</sub> )	3 ... 10 / 6 ... 20 / 15 ... 30 kV
Total length (l <sub>G</sub> )	1565 mm
Insertion depth (l <sub>o</sub> )	770 mm

Voltage detectors for other nominal voltages and frequencies are available on request.

## ASP Non-Contact Voltage Detector

Nominal voltage range 110 ... 420 kV / 50 Hz

Safety Equipment

Voltage Detectors



ASP non-contact voltage detector used in an outdoor switching station

### General Information:

Temperature range	– 25 °C ... + 55 °C
Use	Suitable for use in wet weather conditions
For	Overhead lines and outdoor switching stations
Indication	Visual and acoustic
Self-testing element	Yes
Design	With universal gear coupling for adjusting the angle of the indicator with test prod
Material (indicator)	Plastic, fully insulated (black)
Material (electric field sensor)	Plastic (black)
Material (insulating stick)	Glass-fibre reinforced polyester tube

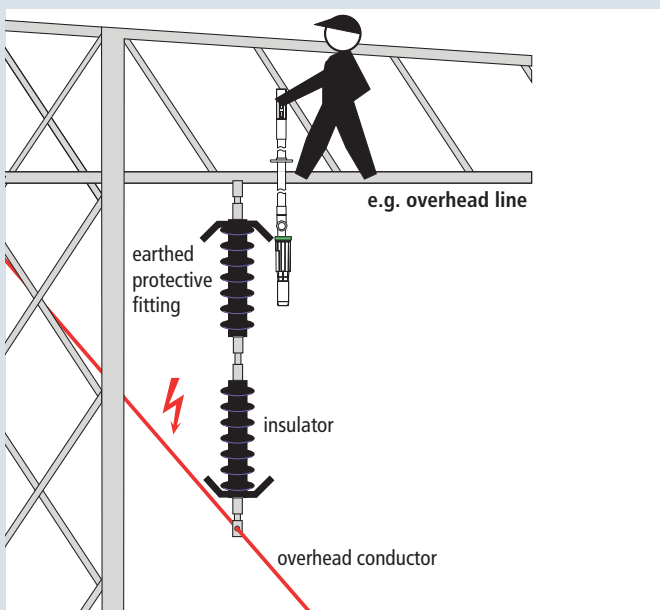

### Use for overhead lines

The green ring on the ASP non-contact voltage detector with category "L" electric field sensor is used to make contact with the last earthed protective fitting in such a way that the electric field sensor points in the direction of the overhead conductor fixed at the other end of the insulator.

### Easy and safe testing

- Easy-to-use due to compact design
- Cost-effective/space-saving transport



### Kit includes:

Pos. No.	Part No.	Pos. No.	Part No.
1	767 576	5	767 593
2	767 577	6	766 369
3	767 591	7	767 574
4	767 592	8	767 996

For more detailed information on these products, see Accessory chapter

### Category "S" and "L"

Devices of category "S" may only be used in outdoor switching stations, devices of category "L" for overhead lines only. Devices of category "S" / "L" may be used both for outdoor switching stations and overhead lines.

### e.g. 110 kV switching stations without earth-sided protective fitting

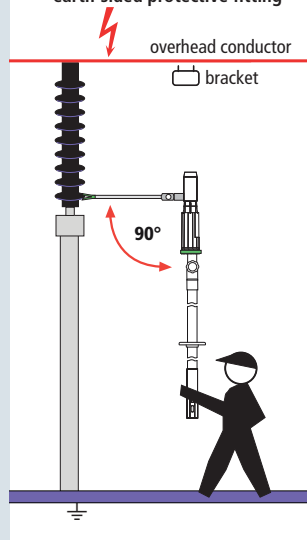

### e.g. 110 kV switching stations with earth-sided protective fitting

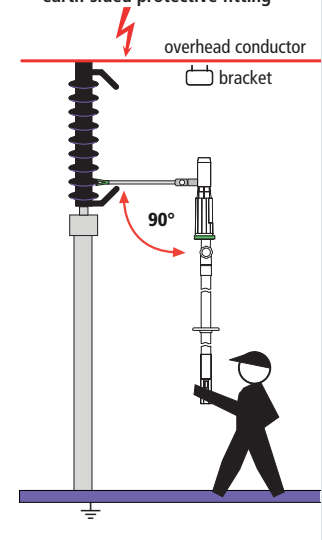

### Use in outdoor switching stations

The green marking on the arm of the ASP non-contact voltage detector with category "S" electric field sensor is used to make contact with the lowest insulator plate at a right angle. If a protective fitting is located on the earth side, contact is made at the next possible insulator plate above the protective fitting.

## Safety Equipment

## ASP Non-Contact Voltage Detector

## Voltage Detectors

## ASP Non-Contact Voltage Detector Kit, Category "L"

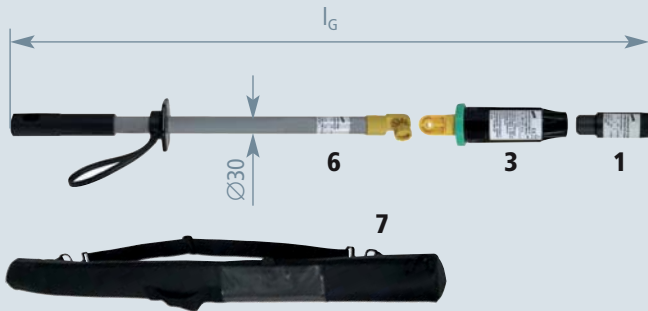

For overhead lines in accordance  
with E DIN VDE 0682-417  
Category "L"

Kit includes:		
Type	Part No.	No.
ASP 110 420 L	767 581	1+3+6
KLT 104 9	767 574	7

Type	ASP 110 420 L
<b>Part No.</b>	<b>767 571</b>
Nominal voltage (U <sub>N</sub> )	110 ... 420 kV
Total length (l <sub>G</sub> )	960 mm

## ASP Non-Contact Voltage Detector Kit, Category "S"

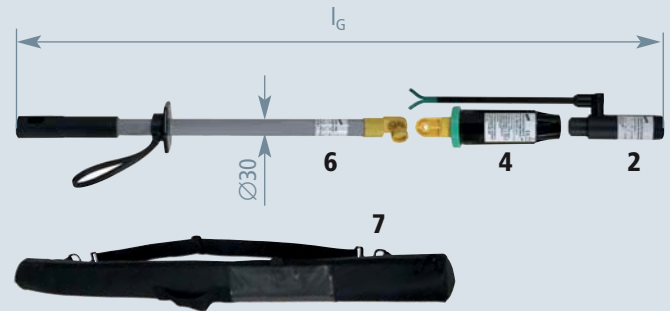

For outdoor switching stations  
Category "S"

Kit includes:		
Type	Part No.	No.
ASP 110 420 S	767 582	2+4+6
KLT 104 9	767 574	7

Type	ASP 110 420 S
<b>Part No.</b>	<b>767 572</b>
Nominal voltage (U <sub>N</sub> )	110 ... 420 kV
Total length (l <sub>G</sub> )	1000 mm

## ASP Non-Contact Voltage Detector

## ASP Non-Contact Voltage Detector Kit, Category "S / L"

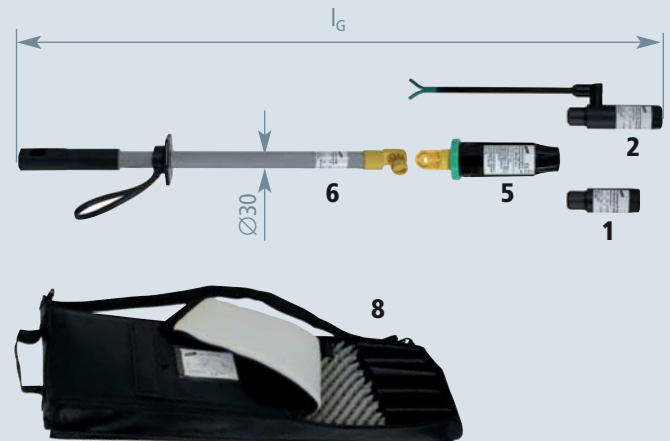

For overhead lines and outdoor  
switching stations  
Category "L" and "S"

Kit includes:		
Type	Part No.	No.
ASP 110 420 S L	767 583	1+2+5+6
KLT 101 30 10	767 996	8

Type	ASP 110 420 S L
<b>Part No.</b>	<b>767 573</b>
Nominal voltage (U <sub>N</sub> )	110 ... 420 kV
Total length (l <sub>G</sub> )	1000 mm

Voltage detectors for other nominal voltages and frequencies as well as indicators with permanent light and continuous acoustic signal instead of flashing light and intermittent acoustic signal are available on request.

## HSA 205 High-Voltage Indicator

Safety Equipment

Nominal voltage range 1 ... 420 kV / 50 Hz

Voltage Detectors



HSA 205 non-contact voltage detector with insulating cap used on a switchgear installation

### General Information:

Temperature range	– 25 °C ... + 55 °C, climatic category N
Use	Suitable for use in wet weather conditions
Indication	Visual and acoustic
Self-testing element	Yes
Material (insulating stick)	Glass-fibre reinforced polyester tube

- For contactless verification of safe isolation from supply voltage on switchgear installations and high-voltage overhead lines
- Wide nominal voltage range
- Storage bag included

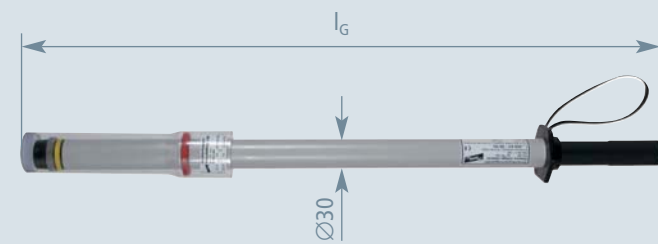

With insulating cap and plug-in coupling as end fitting for extending the handle

Type	HSA205 U 1 420 STK
Part No.	767 552
Nominal voltage range ( $U_N$ )	1 ... 30 / 30 ... 220 / 110 ... 420 V
Frequency	50 Hz
Total length ( $l_G$ )	950 mm

HSA 205 non-contact voltage detectors with Lithium batteries for other nominal voltages and frequencies are available on request.  
**ATTENTION: These HSA 205 non-contact voltage detectors may not be sold in Germany!**

Minimum distances A according to nominal voltage:		
Selected voltage range	Nominal voltage acc. to DIN VDE 0105 Part 1	Min. safety distance A
Red 1 ... 30 kV	1 up to 6 kV	90 mm indoor installations
	6 up to 10 kV	120 mm indoor installations
	1 up to 10 kV	150 mm outdoor installations
	10 up to 20 kV	220 mm indoor and outdoor installations
	20 up to 30 kV	320 mm indoor and outdoor installations
White 30 ... 220 kV	30 up to 45 kV	480 mm indoor and outdoor installations
	45 up to 60 kV	630 mm indoor and outdoor installations
	60 up to 110 kV	1100 mm indoor and outdoor installations
Yellow 110 ... 420 kV	110 up to 220 kV	2100 mm indoor and outdoor installations
	220 up to 420 kV	2900/3400 mm indoor and outdoor installations

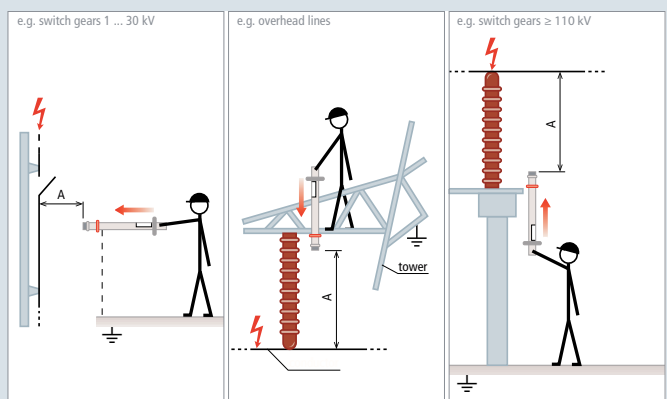

### Application notes

The operating head of HSA 205 non-contact voltage detectors is fitted with a yellow switching ring, which is used to set the required nominal voltage range, either 1 to 30 kV, 30 to 220 kV or 110 to 420 kV. Provided that the insulating tube and cap of the non-contact voltage detector is in a dry and clean condition, the minimum distance A can be reduced for nominal voltages up to 30 kV. If these conditions cannot be ensured, the minimum distance A must be maintained!



## Safety Equipment

## PHG II Voltage Detector

## Voltage Detectors

Nominal voltages up to 20 kV / 50 Hz

## Easy and safe testing

- Cost-effective
- Reliable indication



PHG II voltage detector used in a type-tested switchgear installation

## Test for correct operation

EN 50110-1 (DIN VDE 0105 Part 100) requires that voltage detectors are tested for correct operation directly before and after they are used.

Voltage detectors without self-testing element must be tested for correct operation by attaching them to parts of the installation connected to operating voltage.

A fork-shaped electrode is situated on the test prod of the voltage detector.

## General Information:

Standard	EN/IEC 61243-1 (DIN VDE 0682 Part 411)
Temperature range	– 25 °C ... + 55 °C, climatic category N
Design	Complete
Use	Not suitable for use in wet weather conditions
For	Indoor installations
Indication	Visual, 3 LEDs
Type	Passive voltage detector without batteries
Material (test electrode)	Cu/gal Sn
Material (test prod)	Glass-fibre reinforced polyester tube
Material (indicator)	Plastic
Material (insulating stick)	Glass-fibre reinforced polyester tube

Nominal voltages up to 20 kV / 50 Hz

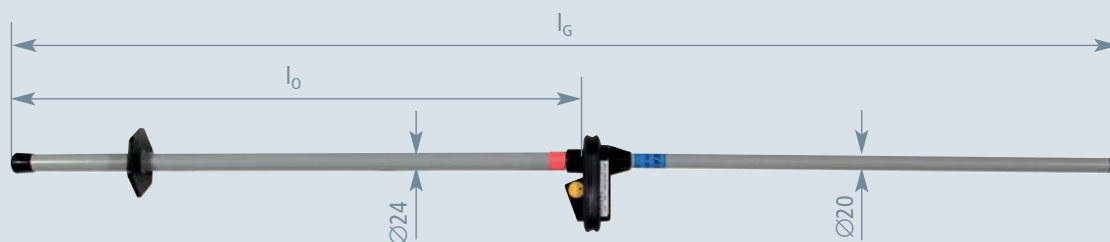

Category "S"

Type	PHG2 6	PHG2 10	PHG2 20
Part No.	766 706	766 710	766 720
Nominal voltage (U <sub>N</sub> )	6 kV	10 kV	20 kV
Total length (l <sub>G</sub> )	1425 mm	1425 mm	1425 mm
Insertion depth (l <sub>0</sub> )	720 mm	720 mm	720 mm

Voltage detectors for special switchgear installations are available on request.

## PHE/G d.c. Voltage Detector

Safety Equipment

Nominal voltage up to 24 kV d.c.

Voltage Detectors



PHE/G II d.c. voltage detector for d.c. links (ICE power car)

### Safe verification of isolation from supply voltage

- For use in direct voltage systems (electrified rail networks, d.c. links)
- Reliable indication
- Easy to use due to compact design
- User-friendly



### General Information:

Standard	Based on EN/IEC 61243-2 (DIN VDE 0682 Part 412)
Temperature range	– 25 °C ... + 55 °C, climatic category N
Use	Suitable for use in wet weather conditions
For	Indoor and outdoor installations, for example d.c. voltage systems (electrified rail networks, d.c. links)
Indication	Visual
Self-testing element	Yes
Material (test prod)	Glass-fibre reinforced polyester tube
Material (indicator)	Plastic, fully insulated
Material (insulating stick)	Glass-fibre reinforced polyester tube
Material (earthing/ connecting cable)	Copper cable, highly flexible

The test prod of d.c. voltage detectors is colour-coded according to the polarity of the test prod:

positive pole – red;

negative pole – blue.

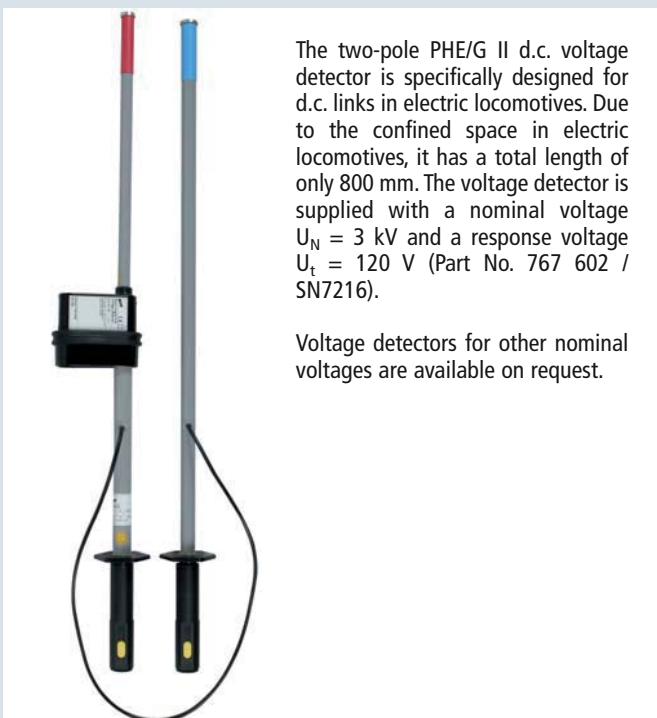

The two-pole PHE/G II d.c. voltage detector is specifically designed for d.c. links in electric locomotives. Due to the confined space in electric locomotives, it has a total length of only 800 mm. The voltage detector is supplied with a nominal voltage  $U_N = 3 \text{ kV}$  and a response voltage  $U_t = 120 \text{ V}$  (Part No. 767 602 / SN7216).

Voltage detectors for other nominal voltages are available on request.



Earth clamp with adjustable handle and magnet

Safety Equipment

PHE/G d.c. Voltage Detector

Voltage Detectors

PHE/G I for Overhead Contact Lines, positive Pole

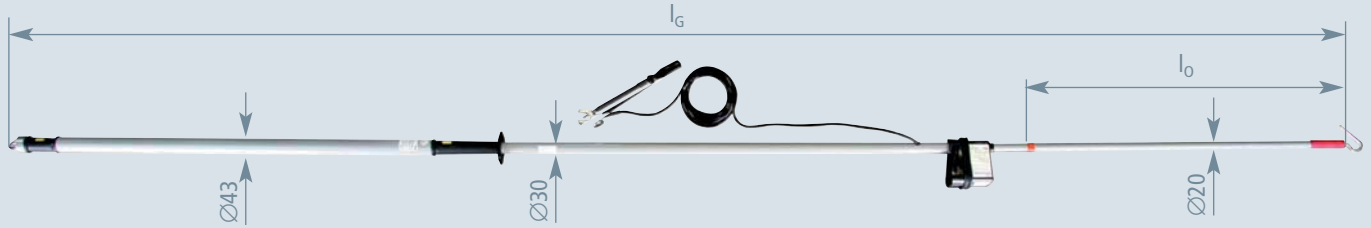

One stick (four elements)

- For direct voltage systems with earthed negative pole
- For nominal voltages up to 24 kV d.c.
- Positive pole: Indicator with test prod
- Negative pole: Earth clamp
- Response voltage  $U_t = 0.5 \times U_N$
- **Nominal voltage ( $U_N$ ) to be specified at order!**

Type	PHEG1.FD P SN7...
Part No.	767 650
Length (earthing cable)	6000 mm
Total length ( $l_G$ )	4120 mm
Insertion depth ( $l_0$ )	1020 mm

PHE/G I for Overhead Contact Lines, negative Pole

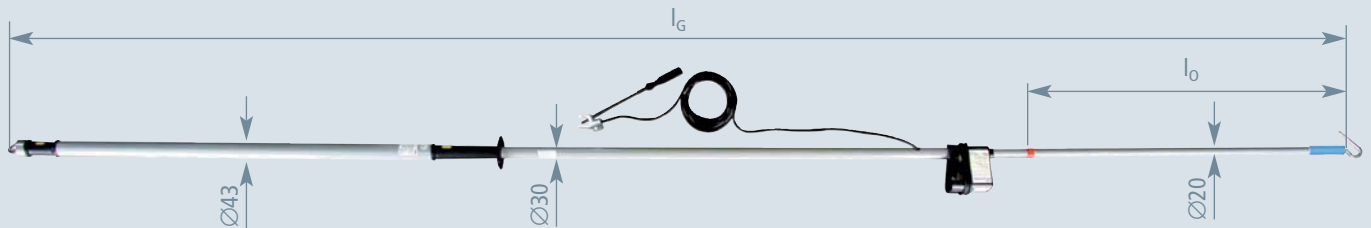

One stick (four elements)

- For direct voltage systems with earthed positive pole
- For nominal voltages up to 24 kV d.c.
- Negative pole: Indicator with test prod
- Positive pole: Earth clamp
- Response voltage  $U_t = 0.5 \times U_N$
- **Nominal voltage ( $U_N$ ) to be specified at order!**

Type	PHEG1.FD M SN7...
Part No.	767 655
Length (earthing cable)	6000 mm
Total length ( $l_G$ )	4120 mm
Insertion depth ( $l_0$ )	1020 mm

PHE/G I for Switchgear Installations, positive Pole

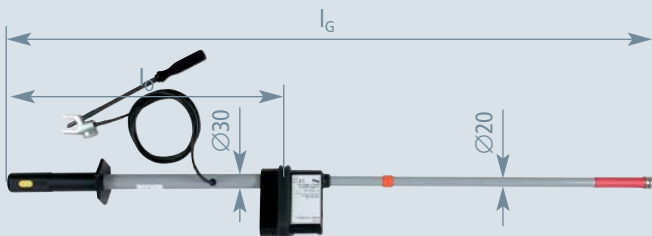

One stick

- For direct voltage systems with earthed negative pole
- For nominal voltages up to 24 kV d.c.
- Positive pole: Indicator with test prod
- Negative pole: Earth clamp
- Response voltage  $U_t = 0.5 \times U_N$
- **Nominal voltage ( $U_N$ ) to be specified at order!**

Type	PHEG1.S P SN7...
Part No.	767 660
Length (earthing cable)	2000 mm
Total length ( $l_G$ )	1260 mm
Insertion depth ( $l_0$ )	530 mm

PHE/G I for Switchgear Installations, negative Pole

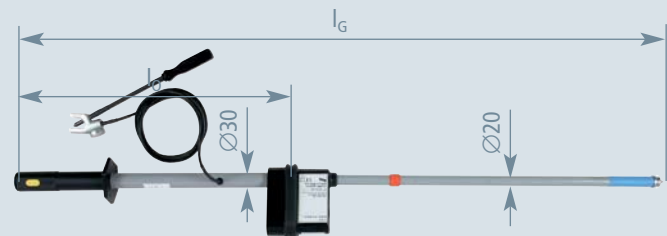

One stick

- For direct voltage systems with earthed positive pole
- For nominal voltages up to 24 kV d.c.
- Negative pole: Indicator with test prod
- Positive pole: Earth clamp
- Response voltage  $U_t = 0.5 \times U_N$
- **Nominal voltage ( $U_N$ ) to be specified at order!**

Type	PHEG1.S M SN7...
Part No.	767 665
Length (earthing cable)	2000 mm
Total length ( $l_G$ )	1260 mm
Insertion depth ( $l_0$ )	530 mm

## PHE/G d.c. Voltage Detector

Safety Equipment

Voltage Detectors

### PHE/G II for Switchgear Installations and d.c. Links up to 24 kV d.c.

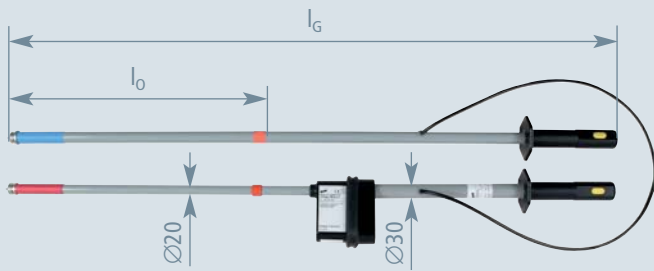

Two sticks

- For unearthed direct voltage systems
- For nominal voltages up to **24 kV d.c.**
- For d.c. links
- Positive pole: Indicator with test prod
- Negative pole: Insulating stick
- Response voltage  $U_t = 0.5 \times U_N$
- **Nominal voltage ( $U_N$ ) to be specified at order!**

Type	PHEG2.P SN7...
Part No.	767 670
Length (connecting cable)	1250 mm
Total length ( $l_G$ )	1250 mm
Insertion depth ( $l_0$ )	540 mm

### PHE/G II for Switchgear Installations and d.c. Links up to 7.5 kV d.c.

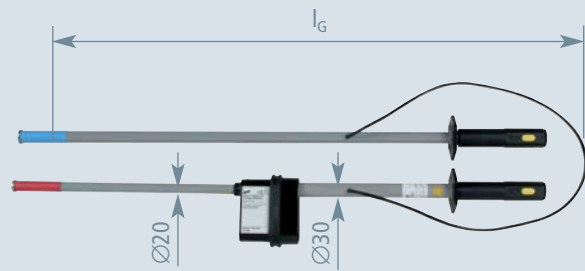

Two sticks

- For unearthed direct voltage systems
- For nominal voltages up to **7.5 kV d.c.**
- For d.c. links (e.g. electric locomotive;  $U_A \leq 120 \text{ V}$ ,  $l_G = 800 \text{ mm}$ )
- Positive pole: Indicator with test prod
- Negative pole: Insulating stick
- Response voltage  $U_t = 0.5 \times U_N$
- **Nominal voltage ( $U_N$ ) to be specified at order!**

Type	PHEG2 P SN7...
Part No.	767 602
Length (connecting cable)	1200 mm
Total length ( $l_G$ )	1075 mm

Other lengths and response values ( $U_t$ ) are available on request.



## Safety Equipment

### Phase Comparators

Phase comparators in accordance with EN/IEC 61481 (DIN VDE 0682 Part 431) are designed for testing in-phase conditions of three-phase systems.

Only electrically skilled or instructed persons are allowed to test in-phase conditions.

Phase comparators have to be tested for correct operation immediately before and after use.

Phase comparators without self-testing element have to be tested for correct operation by making contact with a part of the installation connected to operating voltage.

Testing in-phase conditions by means of a phase comparator is considered live working.

Phase comparators may only be used for the nominal voltage / nominal voltage range as indicated on the rating plate. The user may be at risk if the phase comparator is used for voltages other than indicated on the rating plate (incorrect indication, electric shock, arcing).

Phase comparators labelled "For indoor and outdoor installations" must not be used in wet weather conditions.

Phase comparators labelled "Also suitable for use in wet weather conditions" may be used in all weather conditions such as rain, snow, fog and dew.

Phase comparators in accordance with IEC/EN 61481 (VDE 0682 Part 431) are only suitable to a limited extent for use in factory assembled (type tested) installations.

Due to the restricted space in these installations, flashover may occur when inserting the test prod into the installation. The user of the phase comparator or the operator of the switchgear installation must contact the manufacturer of the type-tested installation to find out whether the phase comparator may be used in the installation.

#### Design of phase comparators

Phase comparators in accordance with IEC/EN 61481 (VDE 0682 Part 431) can be designed as **two-pole devices** (resistive phase comparators) or as **single-pole devices** (capacitive phase comparators).

The design of single-pole phase comparators is similar to that of capacitive voltage detectors. The functional principle of single-pole phase comparators is based on a microprocessor controlled electronic storage system.

Classified as complete devices, PHV and PHV I phase comparators are tested as a complete unit.

Single-pole phase comparators consist of a handle with hand guard, insulating element, indicator and test prod with test electrode. Two-pole phase comparators additionally have a connecting cable.

The **insulating element** is the section of a phase comparator between the hand guard and the red ring. It ensures that the user maintains an adequate safety distance for safe operation.

The **test prod** with contact electrode above the red ring allows to reach remote parts of the installation and to eliminate the influence of interference fields.

The **hand guard** provides a visible barrier between the handle and the insulating element and prevents the user from making contact with the insulating element.

The **red ring** indicates the end of the insulating element in the direction of the test electrode. This provides the user with a visible limit of contact with live parts in the installation. The insulating element situated between the red ring and the hand guard must not contact live parts, however, it may contact earthed parts.

The **test electrode** is the part of the phase comparator that is used to make contact with the part of the installation to be tested.

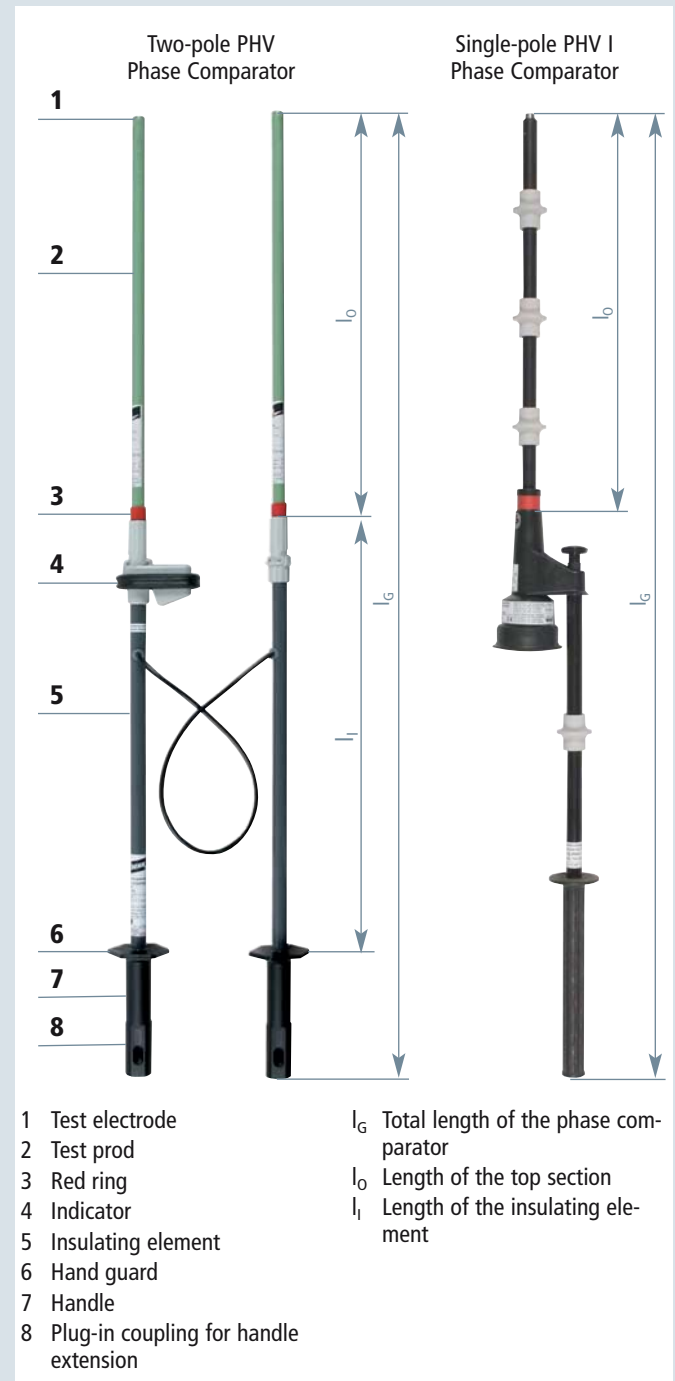

### Storage Bags and Transport Cases

Sheet metal or plastic case  
Artificial leather or canvas bag

187



## Two-pole PHV Phase Comparator

Safety Equipment

Nominal voltages up to 36 kV / 50 Hz

Phase Comparators



### Easy and safe testing

- Easy to use
- User-friendly
- Cost-effective/space-saving transport



Two-pole PHV phase comparator with a pair of green test prods (15 ... 24 kV) used in a 20 kV switchgear installation

#### General Information:

Standard	EN/IEC 61481 (DIN VDE 0682 Part 431)
Temperature range	- 25 °C ... + 55 °C, climatic category N
Use	Not suitable for use in wet weather conditions
Material (test electrode)	Copper alloy/gal Sn
For	Indoor and outdoor installations
Material (test prod)	Glass-fibre reinforced epoxy resin tube
Material (indicator)	Plastic, fully insulated
Material (insulating stick)	Glass-fibre reinforced epoxy resin tube
Connecting cable	Flexible copper cable, plastic-insulated



## PHV Test Unit

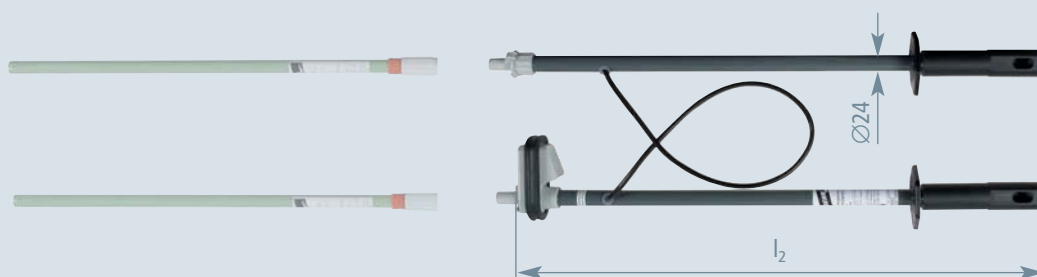

The two-pole PHV phase comparator consists of a test unit and two test prods which are attached to the test unit (to be ordered separately). To avoid confusion, the test prods have different colours according to the nominal voltage.

Type	PHV 3 36 STK
Part No.	759 300
Nominal voltage (U <sub>n</sub> )	3 ... 36 kV
Colour	Grey
Length (test unit) (l <sub>2</sub> )	750 mm
Length (connecting cable)	800 mm

Other connecting cable lengths as well as versions for other nominal voltages and for special switchgear installations are available on request.

## Safety Equipment

## Two-pole PHV Phase Comparator

## Phase Comparators

## Straight Test Prods

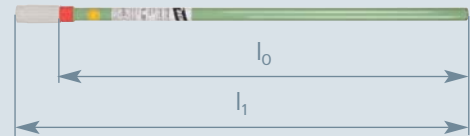

Note: Two tests prods are required for a test unit.

Type	PS 3 3.6 PHV	PS 5 7.2 PHV	PS 10 12 PHV	PS 10 17.5 PHV	PS 15 24 PHV	PS 25 36 PHV
Part No.	759 603	759 605	759 610	759 615	759 620	759 630
Nominal voltage ( $U_N$ )	3 ... 3.6 kV	5 ... 7.2 kV	10 ... 12 kV	10 ... 17.5 kV	15 ... 24 kV	25 ... 36 kV
Colour	Grey	White	Yellow	Grey	Green	Grey
Length (test prod) ( $l_1$ )	381 mm	681 mm	681 mm	681 mm	681 mm	681 mm
Insertion depth ( $l_0$ )	316 mm	616 mm	616 mm	616 mm	616 mm	616 mm
Diameter	20 mm	20 mm	20 mm	20 mm	20 mm	20 mm

## Test Prods (Ø11 mm)

For type-tested, factory assembled switchgear installations with limited access (e.g. Mipak)

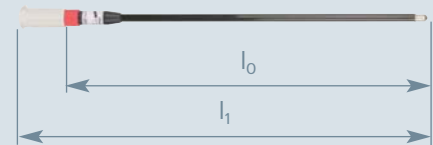

Note: Two tests prods are required for a test unit.

Type	PS 10 12 PHV D11	PS 20 24 PHV D11
Part No.	759 111	759 121
Nominal voltage ( $U_N$ )	10 ... 12 kV	20 ... 24 kV
Colour	Black	Black
Length (test prod) ( $l_1$ )	415 mm	585 mm
Insertion depth ( $l_0$ )	330 mm	520 mm
Diameter	11 mm	11 mm

## Long Test Prods

For type-tested, factory assembled switchgear installations with remotely situated series-connected contacts (e.g. Driescher D600)



Note: Two tests prods are required for a test unit.

Type	PS 15 24 PHV L880
Part No.	759 621
Nominal voltage ( $U_N$ )	15 ... 24 kV
Colour	Grey
Length (test prod) ( $l_1$ )	880 mm
Insertion depth ( $l_0$ )	820 mm
Diameter	20 mm

## 90° angled Test Prods

For type-tested, factory assembled switchgear installations with limited access and contacts situated in a vertical plane (e.g. Alstom)

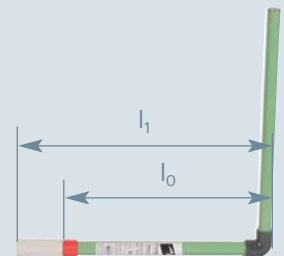

Note: Two tests prods are required for a test unit.

Type	PS 3 3.6 PHV W90	PS 5 7.2 PHV W90	PS 10 12 PHV W90	PS 15 24 PHV W90	PS 25 36 PHV W90
Part No.	759 604	759 608	759 611	759 622	759 633
Nominal voltage ( $U_N$ )	3 ... 3.6 kV	5 ... 7.2 kV	10 ... 12 kV	15 ... 24 kV	25 ... 36 kV
Colour	Grey	White	Yellow	Green	Grey
Length (test prod) ( $l_1$ )	359 mm	359 mm	359 mm	359 mm	359 mm
Insertion depth ( $l_0$ )	274 mm	274 mm	274 mm	274 mm	274 mm
Diameter	20 mm	20 mm	20 mm	20 mm	20 mm

## Single-pole PHV I Phase Comparator

Safety Equipment

Nominal voltages up to 36 kV / 50 Hz

Phase Comparators



Safe testing

- Reliable indication



Single-pole PHV I phase comparator used in a switchgear installation

### General Information:

Standard	EN/IEC 61481 (DIN VDE 0682 Part 431)
Temperature range	-25 °C ... +55 °C, climatic category N
Use	Suitable for use in wet weather conditions
For	Indoor and outdoor installations
Material (test prod)	Plastic
Material (indicator)	Plastic, fully insulated
Material (insulating stick)	Glass-fibre reinforced polyester tube

### Nominal Voltage Ranges up to 36 kV / 50 Hz

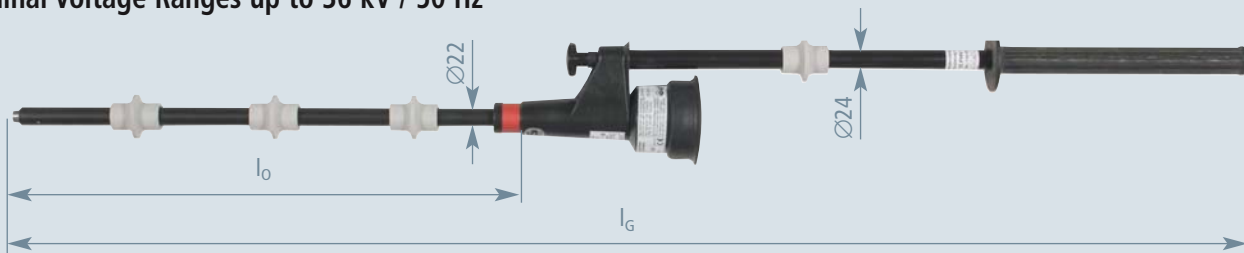

Type	PHV1 6 12	PHV1 12 24	PHV1 24 36
Part No.	759 606	759 612	759 624
Nominal voltage (U <sub>N</sub> )	6 ... 12 kV	12 ... 24 kV	24 ... 36 kV
Total length (l <sub>G</sub> )	1400 mm	1600 mm	1600 mm
Insertion depth (l <sub>0</sub> )	575 mm	775 mm	775 mm

### Nominal Voltage Ranges up to 36 kV / 50 Hz, switchable via Selector Ring



Type	PHV1 U 6 36
Part No.	759 616
Nominal voltage (U <sub>N</sub> )	6 ... 12 / 12 ... 24 / 24 ... 36 kV
Total length (l <sub>G</sub> )	1600 mm
Insertion depth (l <sub>0</sub> )	775 mm

## Voltage Detecting Systems

Metal-encapsulated switchgear installations, typically SF6 gas-insulated, have become widely accepted in the field of switchgear construction. In these types of installation, conventional voltage detectors can often not be used for verifying safe isolation from supply voltage in accordance with EN/IEC 61243-1 (DIN VDE 0682 Part 411).

For this reason, capacitive voltage detecting systems in accordance with IEC/EN 61243-5 (DIN VDE 0682 Part 415) have been developed for verifying safe isolation from supply voltage on all poles at the work location in accordance with EN 50110-1 (DIN VDE 0105 Part 100).

Only electrically skilled or instructed persons are allowed to verify safe isolation from supply voltage.

## Electrical and mechanical interface requirements for separable HR, LR and LRM voltage detecting systems

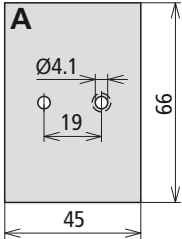
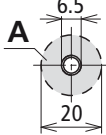
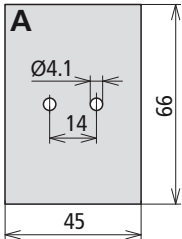
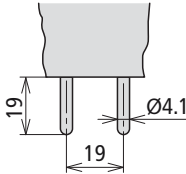
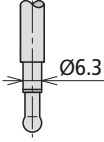
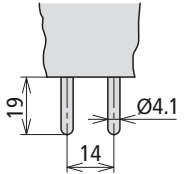
System description		HR High resistance	LR low resistance	LRM low resistance, modified
Input impedance of the indicator	$X_C$	36 M $\Omega$	2 M $\Omega$	2 M $\Omega$
Electrical response conditions of the interface	I	2.5 $\mu$ A	2.5 $\mu$ A	2.5 $\mu$ A
Electrical response conditions of the interface	U	90 V	5 V	5 V
Socket arrangement and minimum spare area A for indicator or plug				
Plug arrangement				





Voltage Detecting Systems

Device	Nominal voltage $U_N$ / Frequency $f_N$	Application, Indication	Page	
DEHNcap/P Voltage Indicator	up to 45 kV / 50 Hz	Passive indicator without batteries LED indication Can also be used as permanent voltage indicator	40	
DEHNcap/P Test Unit	230 V / 50 Hz	For testing for correct operation Plugs into 230 V socket outlets For HR and LRM indicators	41	
DEHNcap/A Voltage Indicator	up to 45 kV / 50 Hz	Active voltage indicator Indication by two separate LEDs With self-testing element and battery monitoring device Automatic deactivation after use	42	
DEHNcap/IT Interface Test Unit	up to 45 kV / 50 Hz	Active indicator for maintenance tests Indication by two separate LEDs With self-testing element and battery monitoring device Automatic deactivation after use	43	
DEHNcap/PC-LRM Phase Comparator	up to 45 kV / 50 Hz	Active indicator for testing in-phase conditions Indication by three separate LEDs Can be used for HR test sockets with two HR-LRM test adapters Comparator detects zero crossings of the installations to be compared With battery monitoring device	44	
DEHNcap HR – LRM Test Set	up to 45 kV / 50 Hz	Fully equipped test set	45	
Storage Bags and Transport Cases		Sheet metal or plastic case Artificial leather or canvas bag	187	

Maintenance tests

According to German regulations (BGV A3), voltage detecting systems have to be tested to compliance with the prescribed limits as stated in the Electrical Safety Rules. This test is performed in the high voltage test laboratory of DEHN + SÖHNE and includes

- measurement of for leakage current,
- test for clear indication,
- test for protection against bridging,
- visual inspection, manual tests and measurements.

This maintenance test is documented in a test report and on the device.

The test intervals depend on the operating conditions of the voltage detecting systems, e.g. frequency of use, environmental conditions and transport. According to German regulations, however, it is advisable to carry out a maintenance test **at least every 6 years**.



## DEHNcap/P Voltage Indicator

Safety Equipment

Nominal voltages up to 45 kV / 50 Hz

Voltage Detecting Systems



DEHNcap/P passive voltage indicator used for an encapsulated switchgear installation

### General Information:

Standard	EN/IEC 61243-5 (DIN VDE 0682 Part 415)
Temperature range	- 25 °C ... + 55 °C
Degree of protection	IP 66
Design	Passive indicator without batteries
Field of application	Can also be used as permanent voltage indicator

- Easy verification of isolation from supply voltage
- Cost-effective

### Test for correct operation

EN 50110-1 (DIN VDE 0105 Part 100) requires that voltage indicators are tested for correct operation shortly before and after use.

Passive indicators without self-testing element must be tested for correct operation by plugging them into test sockets connected to operating voltage or into a test unit (DEHNcap/P test unit).

## DEHNcap/P – HR



Type	SAG DCA P HR
Part No.	767 101
Dimensions	40 x 48 x 35 mm
Plug spacing	19 mm
Indication threshold (HR system)	90 V
Input impedance (HR system)	36 Mohms

## DEHNcap/P – LRM



Type	SAG DCA P LRM
Part No.	767 102
Dimensions	40 x 48 x 35 mm
Plug spacing	14 mm
Indication threshold (LRM system)	5 V
Input impedance (LRM system)	2 Mohms

## Safety Equipment

## DEHNcap/P Test Unit

## Voltage Detecting Systems

Nominal voltages up to 230 V / 50 Hz

- Test unit for testing DEHNcap/P voltage indicators for correct operation
- Plugs into 230 V socket outlets



Test unit for testing a DEHNcap/P passive voltage indicator plugged into a 230 V socket outlet for correct operation

Test unit for testing DEHNcap/P voltage indicators or other HR (HO) or LRM indicators for correct operation. Both HR and LRM devices can be used for testing.

The test unit is plugged into the mains socket outlet and generates both test voltages for HR and LRM systems.

**General Information:**

Temperature range	- 25 °C ... + 55 °C
Field of application	For HR and LRM indicators

Nominal voltages up to 230 V / 50 Hz



Type	TG DCA
<b>Part No.</b>	<b>767 110</b>
Dimensions	43 x 75 x 35 mm
Test voltage (HR system)	90 V a.c.
Socket spacing (HR system)	19 mm
Test voltage (LRM system)	5 V a.c.
Socket spacing (LRM system)	14 mm
Nominal capacity	500 mW
Max. short-circuit current at the test socket	approximately 20 µA

## DEHNcap/A Voltage Indicator

Safety Equipment

Nominal voltages up to 45 kV / 50 Hz

Voltage Detecting Systems



Self-test of a DEHNcap/A voltage indicator

### Safe verification of isolation from supply voltage

- User-friendly
- Easy to use



#### General Information:

Standard	EN/IEC 61243-5 (DIN VDE 0682 Part 415)
Temperature range	- 25 °C ... + 55 °C
Field of application	Active voltage indicator for testing
Self-testing element and battery monitoring	Yes

#### Self-testing element

DEHNcap/A electronic voltage indicators have an integrated self-testing element. By simply pressing the test button, the electronic circuit is tested for correct operation. The self-test is automatically performed as soon as the indicator is switched on. The voltage indicator is only operational if the test button is pressed, i.e. the function test was performed successfully.

### DEHNcap/A – HR



Type	SAG DCA A HR
Part No.	767 111
Dimensions	120 x 60 x 25 mm
Plug spacing	19 mm
Type of plug	2 multilam plugs (Ø4 mm)
Indication threshold (HR system)	90 V
Input impedance (HR system)	36 Mohms

### DEHNcap/A – LRM



Type	SAG DCA A LRM
Part No.	767 112
Dimensions	120 x 60 x 25 mm
Plug spacing	14 mm
Type of plug	2 multilam plugs (Ø4 mm)
Indication threshold (LRM system)	5 V
Input impedance (LRM system)	2 Mohms



## Safety Equipment

## Voltage Detecting Systems

## Easy and safe testing

## DEHNcap/IT Interface Test Unit

Nominal voltages up to 45 kV / 50 Hz



DEHNcap/IT interface test unit allows to carry out maintenance tests on coupling systems of switchgear installations according to IEC/EN 61243-5 (DIN VDE 0682 Part 415).

## Self-testing element

The DEHNcap/IT interface test unit has an integrated self-testing element. By simply pressing the test button, the electronic circuit is tested for correct operation. The self-test is automatically performed as soon as the indicator is switched on. The interface test unit is only operational if the test button is pressed i.e. the function test was performed successfully.

## General Information:

Standard	EN/IEC 61243-5 (DIN VDE 0682 Part 415)
Temperature range	- 25 °C ... + 55 °C
Field of application	Active indicator for maintenance test of coupling systems
Self-testing element and battery monitoring	Yes

## DEHNcap/IT – HR



Type	SPG DCA IT HR
Part No.	767 121
Dimensions	120 x 60 x 25 mm
Plug spacing	19 mm
Type of plug	2 multilam plugs (∅4 mm)
Input impedance (HR system)	36 Mohms
Test threshold	3.2 µA

## DEHNcap/IT – LRM



Type	SPG DCA IT LRM
Part No.	767 122
Dimensions	120 x 60 x 25 mm
Plug spacing	14 mm
Type of plug	2 multilam plugs (∅4 mm)
Input impedance (LRM system)	2 Mohms
Test threshold	3.2 µA

## DEHNcap/PC-LRM Phase Comparator

Safety Equipment

Nominal voltages up to 45 kV / 50 Hz

Voltage Detecting Systems



DEHNcap/PC-LRM phase comparator with two HR-LRM test adapters used for an HR switchgear installation

### General Information:

Standard	EN/IEC 61243-5 (DIN VDE 0682 Part 415)
Temperature range	- 25 °C ... + 55 °C
Design	Active indicator for verifying in-phase conditions on LRM test sockets
Field of application	For HR test sockets with two HR-LRM test adapters
Self-testing element and battery monitoring	Yes

## DEHNcap/PC – LRM



Type	PV DCA PC LRM
Part No.	767 132
Dimensions	145 x 85 x 32 mm
Measuring cables	3 measuring cables with multilam plug (Ø4 mm)
Length (measuring cable)	2000 mm
Indication threshold (LRM system)	5 V
Input impedance (LRM system)	2 Mohms

### Easy and safe testing

- User-friendly
- Easy to use



By attaching two optional HR-LRM adapters (Part No. 767 133), the DEHNcap/PC-LRM phase comparator can also be used for phase comparison in HR systems. DEHNcap/PC-LRM is designed as a universal phase comparator in accordance with EN/IEC 61243-5 (DIN VDE 0682 Part 415) and detects zero crossings, but no voltage values.

## DEHNcap/PC – LRM Phase Comparator Kit



Phase comparator in an artificial leather bag, Part No. 767 500

Type	PV DCA PC LRM T
Part No.	767 139
Dimensions	145 x 85 x 32 mm
Measuring cables	3 measuring cables with multilam plug (Ø4 mm)
Length (measuring cable)	2000 mm
Indication threshold (LRM system)	5 V
Input impedance (LRM system)	2 Mohms

## Safety Equipment

## DEHNcap HR – LRM Test Set

## Voltage Detecting Systems

Nominal voltages up to 45 kV / 50 Hz

## Easy and safe testing

- Complete test set for universal use
- Easy to use



Set in a plastic case for verifying safe isolation from supply voltage and in-phase conditions in HR and LRM systems

**General Information:**

Standard	EN/IEC 61243-5 (DIN VDE 0682 Part 415)
Temperature range	- 25 °C ... + 55 °C

Nominal voltages up to 45 kV / 50 Hz

Kit includes:			
Pos. No.	Part No.	Pos. No.	Part No.
1	1x 767 112	4	2x 767 133
2	1x 767 122	5	1x 767 107
3	1x 767 132		
For more detailed information on these products, see Accessory chapter			



Set in a plastic case for verifying safe isolation from supply voltage and in-phase conditions in HR and LRM systems

**Type**

PS DCA HR LRM

**Part No.**

767 150

## Dimensions

395 x 295 x 105 mm

## DEHNcap Test Adapter /Measuring Impedance

Safety Equipment

Voltage Detecting Systems



The HR-LRM test adapter allows to plug an LRM indicator into a HR test socket

- Easy and safe testing
- Easy mechanical and electrical adaptation to HR, LR or XC test sockets
- Measuring impedance for maintenance tests on coupling systems with suitable  $\mu\text{A}$  meter
- 4 mm safety plugs or sockets
- Energised HR plug, insulated

### General Information:

Standard	EN/IEC 61243-5 (DIN VDE 0682 Part 415)
Temperature range	- 25 °C ... + 55 °C

### HR-LRM Test Adapter



For electrical and mechanical adaptation of HR (HO) to LRM systems. Used as a measuring impedance with  $X_C = 36$  Mohms for maintenance tests on HR coupling systems (with suitable  $\mu\text{A}$  meter).

Type	MA DCA HR LRM
Part No.	767 133
Dimensions	90 x 50 x 30 mm
Plug spacing	19 mm
Socket spacing	14 mm
Type of plug	2 multilam plugs ( $\varnothing 4$ mm)
Type of test socket	2 sockets ( $\varnothing 4$ mm)

### LR-LRM Test Adapter



For mechanical adaptation of LR (NO) to LRM systems

Type	MA DCA LR LRM
Part No.	767 136
Dimensions	100 x 50 x 30 mm
Plug spacing	jack, 6.3 mm
Socket spacing	14 mm
Type of plug	1 jack
Type of test socket	2 sockets ( $\varnothing 4$ mm)

### XC-LRM Measuring Impedance



Used as a measuring impedance with  $X_C = 2$  Mohms for maintenance tests on LRM coupling systems (with suitable  $\mu\text{A}$  meter).





Type	MA DCA XC LRM
Part No.	767 135
Dimensions	90 x 50 x 30 mm
Plug spacing	14 mm
Socket spacing	16 mm
Type of plug	2 multilam plugs ( $\varnothing 4$ mm)
Type of test socket	2 sockets ( $\varnothing 4$ mm)

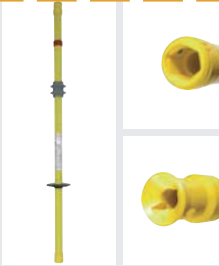

## Safety Equipment

## Selection Guide

## Operating Sticks

Device	Nominal Voltage $U_N$ / Frequency $f_N$	Application	Page	
IS STK Insulating Stick Kit	up to 36 kV / 50 Hz	Suitable for use in wet weather conditions	48	
		For use in indoor and outdoor installations	50	
		Plug-in coupling protected against twisting and bridging		
		Easy transport due to detachable sticks		
		Kits for a variety of applications		
		For use as switching stick, earthing stick or operating stick		
IS Insulating Sticks	up to 123 kV / 50 Hz	For use in wet weather conditions	52	
		For use in indoor and outdoor installations	54	
		Attachable switching stick head allows for use as switching stick		
		Supporting head for hexagon shaft or T pin shaft		
		For use as earthing stick		
		For use as operating stick for insulating protective shutters		
SCS Switching Sticks	up to 123 kV / 50 Hz	For use in wet weather conditions	56	
		For indoor and outdoor installations	57	
		Fully insulated, massive switching stick head		
		Allows deep access into the installation		
		For use as operating stick for insulating protective shutters		
SZ Fuse Tong	up to 36 kV	Not suitable for use in wet weather conditions	58	
		Operating head with two adjustable jaws		
		Straight or 20° angled operating head		
		Secure clamping		
		Wide clamping range $\varnothing 30 \dots 90$ mm		
RST Rescue Rods	up to 36 kV / 50 Hz	Not suitable for use in wet weather conditions	60	
		For use in indoor and outdoor installations		
		Fully insulated and fixed rescue hook		
		For rescuing persons weighing up to approximately 100 kg from the live working zone in the event of an electrical accident		
Storage Bags and Transport Cases		Sheet metal or plastic case	187	
		Artificial leather or canvas bag		

## Maintenance tests

According to German regulations (BGV A3), operating sticks have to be tested for compliance with the prescribed limits as stated in the Electrical Safety Rules. This test is performed in the high voltage test laboratory of DEHN + SÖHNE and includes

- measurement of the leakage current,
- test for protection against bridging,
- visual inspection, manual tests and measurements.

This maintenance test is documented in a test report and on the device.

Prior to each use, operating sticks must be visually inspected for signs of damage or any other defect.





**IS STK Insulating Stick Kit with Silicon Rubber Insulator**

Safety Equipment

Nominal voltages up to 36 kV / 50 Hz

Operating Sticks



IS STK insulating stick fitted with STK switching stick head used as switching stick

**General Information:**

Standard (switching stick head)	DIN VDE 0681 Part 2
Standard (insulating stick)	EN/IEC 61243-1 (DIN VDE 0682 Part 411) test for protection against bridging (section 6.3.2) after wet test and leakage current measurement (section 7.1.2)
Standard (switching stick)	DIN VDE 0681 Part 1 and 2
Standard (operating stick)	DIN VDE 0682 Part 552
Standard (earthing stick)	Based on EN/IEC 61230 (DIN VDE 0683 Part 100)
Use	Suitable for use in wet weather conditions
For	Indoor and outdoor installations



Anti-rotation plastic plug-in coupling used as insulating stick extension (yellow coupling)

**Easy and safe working**

- Cost-effective due to universal use
- Space-saving transport

**Kit includes:**

Pos. No.	Part No.	Pos. No.	Part No.
1	766 164	6	766 468
2	766 365	7	766 456
3	766 465	8	766 466
4	766 356	9	766 996
5	766 367		

For more detailed information on these products, see Accessory chapter



The artificial leather bag with reinforced back panel allows for safe transport and easy storage of the single components.



Dirt-repellent end fittings with plug-in coupling

**Accessory for IS STK Insulating Stick Kit****Operating Head with plug-in Coupling / hexagon Shaft**

For indoor use

Type	AK 36 SK STK 330
Part No.	766 364
Diameter	30 mm
Total length (l <sub>G</sub> )	330 mm
Material	Plastic
Colour	Yellow



## Safety Equipment

## IS STK Insulating Stick Kit with Silicon Rubber Insulator

## Operating Sticks

## Switching Stick Kit (Ø30 mm)

$l_{G \max} (1 + 4 + 4 + 5)$

Possible lengths:	
Length $l_G$	No.
3420 mm	1+4+4+5
2590 mm	1+4+5
1760 mm	1+5

Type	SCSSN 36 STK 30
Part No.	766 324
Nominal voltage ( $U_N$ )	Up to 36 kV
Max. total length ( $l_{G \max}$ )	3450 mm

## Operating Stick Kit (Ø30 mm)

$l_{G \max} (1/2 + 4 + 5)$

Permissible loads for the insulating stick kit:		
Length $l_G$	No.	Max. load on the operating head
2590 mm	1+4+5	5 kg
2390 mm	2+4+5	5 kg
1760 mm	1+5	12 kg
1560 mm	2+5	12 kg

Type	ASSN 36 STK 30
Part No.	766 326
Nominal voltage ( $U_N$ )	Up to 36 kV
Max. total length ( $l_{G \max}$ )	2590 mm

## Operating Stick Kit (Ø43 mm)

$l_{G \max} (1/2 + 4 + 6 + 7)$

Permissible loads for the insulating stick kit:		
Length $l_G$	No.	Max. load on the operating head
3420 mm	1+4+6+7	9 kg
3220 mm	2+4+6+7	9 kg
2590 mm	1+4+6	9 kg
2390 mm	2+4+6	9 kg
1760 mm	1+6	25 kg
1560 mm	2+6	35 kg

Type	ASSN 36 STK 43
Part No.	766 453
Nominal voltage ( $U_N$ )	Up to 36 kV
Max. total length ( $l_{G \max}$ )	3420 mm

## Earthing Stick Kit (Ø43 mm)

$l_{G \max} (2/3 + 6 + 8 + 8)$

Permissible loads for the insulating stick kit:		
Length $l_G$	No.	Max. load on the operating head
3960 mm	2/3+6+8+8	8 kg
2760 mm	2/3+6+8	14 kg
1560 mm	2/3+6	35 kg

Type	ESSN STK 43
Part No.	766 451
Max. total length ( $l_{G \max}$ )	3960 mm

## IS STK Insulating Stick Kit

Safety Equipment

Nominal voltages up to 36 kV / 50 Hz

Operating Sticks



IS STK insulating stick fitted with STK switching stick head used as switching stick

### General Information:

Standard (switching stick head)	DIN VDE 0681 Part 2
Standard (insulating stick)	DIN VDE 0681 Part 1
Standard (switching stick)	DIN VDE 0681 Part 1 and 2
Standard (operating stick)	DIN VDE 0682 Part 552
Standard (earthing stick)	Based on EN/IEC 61230 (DIN VDE 0683 Part 100)
Use	Not suitable for use in wet weather conditions
For	Indoor and outdoor installations



Anti-rotation plastic plug-in coupling used as insulating stick extension (yellow coupling)

- Easy and safe working
- Cost-effective due to universal use
- Space-saving transport



Kit includes:			
Pos. No.	Part No.	Pos. No.	Part No.
1	766 164	6	766 463
2	766 365	7	766 456
3	766 465	8	766 466
4	766 356	9	766 996
5	766 363		

For more detailed information on these products, see Accessory chapter



The artificial leather bag with reinforced back panel allows for safe transport and easy storage of the single components.



Dirt-repellent end fittings with plug-in coupling

### Accessory for IS STK Insulating Stick Kit

#### Operating Head with plug-in Coupling / hexagon Shaft

For indoor use



Type	AK 36 SK STK 330
Part No.	766 364
Diameter	30 mm
Total length (l <sub>G</sub> )	330 mm
Material	Plastic
Colour	Yellow

Safety Equipment

IS STK Insulating Stick Kit

Operating Sticks

Switching Stick Kit (Ø30 mm)

$I_{G \max} (1 + 4 + 4 + 5)$

Possible lengths:	
Length $I_G$	No.
3420 mm	1+4+4+5
2590 mm	1+4+5
1760 mm	1+5

Type	SCSS 36 STK 30
Part No.	766 323
Nominal voltage ( $U_N$ )	Up to 36 kV
Max. total length ( $I_{G \max}$ )	3420 mm

Operating Stick Kit (Ø30 mm)

$I_{G \max} (1/2 + 4 + 5)$

Permissible loads for the insulating stick kit:		
Length $I_G$	No.	Max. load on the operating head
2590 mm	1+4+5	5 kg
2390 mm	2+4+5	5 kg
1760 mm	1+5	12 kg
1560 mm	2+5	12 kg

Type	ASS 36 STK 30
Part No.	766 325
Nominal voltage ( $U_N$ )	Up to 36 kV
Max. total length ( $I_{G \max}$ )	2590 mm

Operating Stick Kit (Ø43 mm)

$I_{G \max} (1/2 + 4 + 6 + 7)$

Permissible loads for the insulating stick kit:		
Length $I_G$	No.	Max. load on the operating head
3420 mm	1+4+6+7	9 kg
3220 mm	2+4+6+7	9 kg
2590 mm	1+4+6	9 kg
2390 mm	2+4+6	9 kg
1760 mm	1+6	25 kg
1560 mm	2+6	35 kg

Type	ASS 36 STK 30 43
Part No.	766 452
Nominal voltage ( $U_N$ )	Up to 36 kV
Max. total length ( $I_{G \max}$ )	3420 mm

Earthing Stick Kit (Ø43 mm)

$I_{G \max} (2/3 + 6 + 8 + 8)$

Permissible loads for the insulating stick kit:		
Length $I_G$	No.	Max. load on the operating head
3960 mm	2/3+6+8+8	8 kg
2760 mm	2/3+6+8	14 kg
1560 mm	2/3+6	35 kg

Type	ESS STK 43
Part No.	766 450
Max. total length ( $I_{G \max}$ )	3960 mm



## IS Insulating Sticks with Silicon Rubber Insulator

Safety Equipment

Nominal voltages up to 123 kV / 50 Hz

Operating Sticks



Switching stick head screwed on an IS SK insulating stick for switching a switch disconnector

### General Information:

Standard (switching stick head)	DIN VDE 0681 Part 2
Standard (insulating stick)	EN/IEC 61243-1 (DIN VDE 0682 Part 411) test for protection against bridging (section 6.3.2) after wet test and leakage current measurement (section 7.1.2)
Standard (operating stick)	DIN VDE 0682 Part 552
Use	Suitable for use in wet weather conditions
For	Indoor and outdoor installations
Material	Glass-fibre reinforced polyester tube
End fitting	Non-slip plastic cap / plug-in coupling for extending the handle



ISN SK insulating stick used for clamps with hexagon shaft of earthing and short-circuiting devices

### Easy and safe working

- Cost-effective since the installation of different supporting heads allows universal use
- Easy to use



SSK M12 switching stick head screwed on ISN SK insulating stick



ISN SQ insulating stick fitted with SSK SQ switching stick head. The insulating stick can be additionally locked by means of the black knurled nut.



The handle of ISN STK insulating sticks can be easily extended via the plug-in coupling

### Accessory for IS Insulating Sticks, rain-proof

#### Screw-on Switching Stick Head for IS SK Insulating Sticks



With M12 thread  
In accordance with DIN VDE 0681 Part 2

Type	SSK M12
Part No.	765 005
Material	Steel, plastic-sheathed

#### Switching Stick Head for IS SQ Insulating Sticks



With T pin shaft (bayonet locking mechanism)  
In accordance with DIN VDE 0681 Part 2  
T pin shaft in accordance with DIN 48087  
Switching stick head is fixed on the insulating stick via the knurled nut

Type	SSK SQ
Part No.	765 009
Material	Polyamide



## Safety Equipment

## IS Insulating Sticks with Silicon Rubber Insulator

## Operating Sticks

## Insulating stick, hexagon Shaft

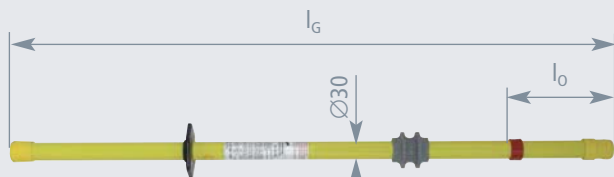

With M12 thread and spring locking mechanism

- Can be used as switching stick by attaching a switching stick head (Part No. 765 005)
- Can be used as earthing stick



NEW

Type	ISN 36 SK 1000	ISN 36 SK 1500
Part No.	766 210	766 215
Nominal voltage (U <sub>N</sub> )	36 kV	36 kV
Total length (l <sub>G</sub> )	1000 mm	1500 mm
Insertion depth (l <sub>o</sub> )	175 mm	475 mm

## Insulating stick, T Pin Shaft



Bayonet locking mechanism

- Can be used as switching stick by attaching a switching stick head (Part No. 765 009)
- Can be used as earthing stick
- Can be used as operating stick for inserting insulating protective shutters



NEW

Type	ISN 36 SQ 1000	ISN 36 SQ 1500
Part No.	766 211	766 216
Nominal voltage (U <sub>N</sub> )	36 kV	36 kV
Max. load on the operating head	17 <sup>*)</sup> kg	17 <sup>*)</sup> kg
Total length (l <sub>G</sub> )	1028 mm	1528 mm
Insertion depth (l <sub>o</sub> )	150 mm	500 mm

<sup>\*)</sup> Max. Shutter weight when used for inserting insulating protective shutters

## Insulating stick, hexagon Shaft, plug-in Coupling

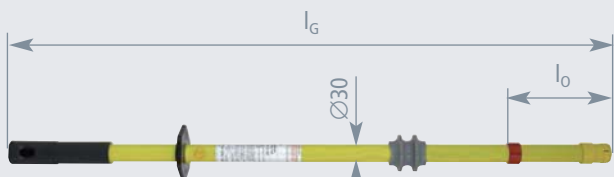

With M12 thread, spring locking mechanism and plug-in coupling for extending the handle

- For use as switching stick with a switching stick head (Part No. 765 005)
- For use as earthing stick



NEW

Type	ISN 36 SK STK 1000
Part No.	766 111
Nominal voltage (U <sub>N</sub> )	36 kV
Total length (l <sub>G</sub> )	1000 mm
Insertion depth (l <sub>o</sub> )	175 mm

## Insulating stick, T Pin Shaft, plug-in Coupling



Bayonet locking mechanism and plug-in coupling for extending the handle

- Can be used as switching stick by attaching a switching stick head (Part No. 765 009)
- Can be used as earthing stick
- Can be used as operating stick for inserting insulating protective shutters



NEW

Type	ISN 36 SQ STK 1000
Part No.	766 310
Nominal voltage (U <sub>N</sub> )	36 kV
Max. load on the operating head	17 <sup>*)</sup> kg
Total length (l <sub>G</sub> )	1025 mm
Insertion depth (l <sub>o</sub> )	150 mm

<sup>\*)</sup> Max. Shutter weight when used for inserting insulating protective shutters

## Modular Insulating stick, hexagon Shaft, plug-in Coupling

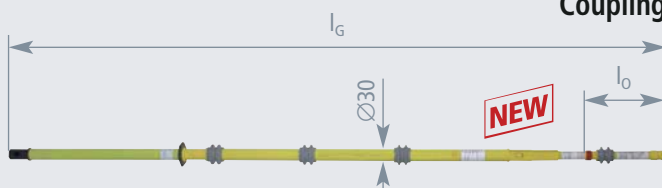

Type	ISN 123 SK STK 2500
Part No.	766 222
Nominal voltage (U <sub>N</sub> )	123 kV
Total length (l <sub>G</sub> )	2500 mm
Insertion depth (l <sub>o</sub> )	287 mm

## Modular Insulating stick, T Pin Shaft, plug-in Coupling

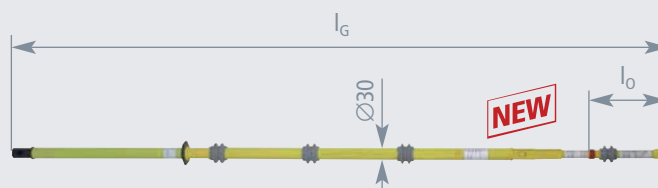

Type	ISN 123 SQ STK 2500
Part No.	766 332
Nominal voltage (U <sub>N</sub> )	123 kV
Total length (l <sub>G</sub> )	2500 mm
Insertion depth (l <sub>o</sub> )	287 mm

## IS Insulating Sticks

Safety Equipment

Nominal voltages up to 123 kV / 50 Hz

Operating Sticks



Switching a disconnector by means of an IS SK insulating stick fitted with switching stick head

### General Information:

Standard (switching stick head)	DIN VDE 0681 Part 2
Standard (insulating stick)	DIN VDE 0681 Part 1
Standard (operating stick)	DIN VDE 0682 Part 552
Use	Not suitable for use in wet weather conditions
For	Indoor and outdoor switchgear installations
Material	Glass-fibre reinforced polyester tube
End fitting	Non-slip plastic cap / plug-in coupling for handle extension



IS SK insulating stick used for clamps with hexagon shaft of earthing and short-circuiting devices

### Easy and safe working

- Cost-effective since the installation of different supporting heads allows universal use
- Easy to use



IS SK insulating stick fitted with SSK M12 switching stick head



IS SQ insulating stick fitted with SSK SQ switching stick head. The black knurled nut is locked into position using the insulating stick.



The handle of IS STK insulating sticks can be easily extended via the plug-in coupling.

## Safety Equipment

## IS Insulating Sticks

## Operating Sticks

## Insulating stick, hexagon Shaft

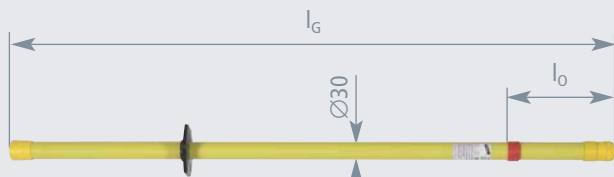

With M12 thread and spring locking mechanism

- Can be used as switching stick by attaching a switching stick head (Part No. 765 005)
- Can be used as earthing stick



Type	IS 36 SK 1000	IS 36 SK 1500
Part No.	766 001	766 002
Nominal voltage (U <sub>N</sub> )	36 kV	36 kV
Total length (l <sub>G</sub> )	1000 mm	1500 mm
Insertion depth (l <sub>o</sub> )	175 mm	475 mm

## Insulating stick, T Pin Shaft

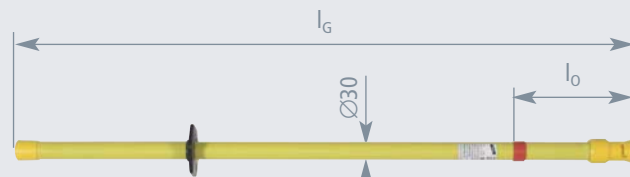

Bayonet locking mechanism

- Can be used as switching stick by attaching a switching stick head (Part No. 765 009)
- Can be used as earthing stick
- Can be used as operating stick for inserting insulating protective shutters



Type	IS 36 SQ 1000	IS 36 SQ 1500
Part No.	766 311	766 315
Nominal voltage (U <sub>N</sub> )	36 kV	36 kV
Max. load on the operating head *)	17 kg	17 kg
Total length (l <sub>G</sub> )	1028 mm	1528 mm
Insertion depth (l <sub>o</sub> )	150 mm	500 mm

\*) Max. shutter weight when inserting insulating protective shutters

## Insulating stick, hexagon Shaft, plug-in Coupling

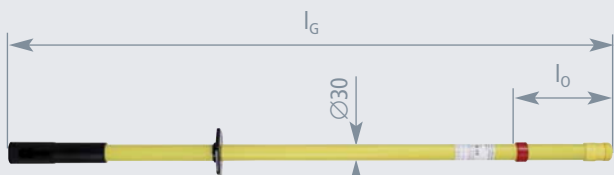

With M12 thread, spring locking mechanism and plug-in coupling for handle extension

- Can be used as switching stick by attaching a switching stick head (Part No. 765 005)
- Can be used as earthing stick



Type	IS 36 SK STK 1000	IS 123 SK STK 2000
Part No.	766 100	766 122
Nominal voltage (U <sub>N</sub> )	36 kV	123 kV
Total length (l <sub>G</sub> )	1000 mm	2000 mm
Insertion depth (l <sub>o</sub> )	175 mm	200 mm

## Insulating stick, T Pin Shaft, plug-in Coupling

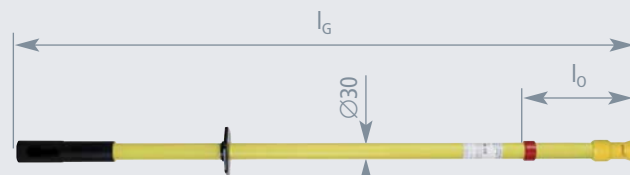

Bayonet locking mechanism and plug-in coupling for extending the handle

- Can be used as switching stick by attaching a switching stick head (Part No. 765 009)
- Can be used as earthing stick
- Can be used as operating stick for inserting insulating protective shutters



Type	IS 36 SQ STK 1000	IS 123 SQ STK 2000
Part No.	766 301	766 322
Nominal voltage (U <sub>N</sub> )	36 kV	123 kV
Max. load on the operating head *)	17 kg	8 kg
Total length (l <sub>G</sub> )	1025 mm	2000 mm
Insertion depth (l <sub>o</sub> )	150 mm	200 mm

\*) Max. shutter weight if used for inserting insulating protective shutters

## Accessory for IS Insulating Sticks

## Screw-on Switching Stick Head for IS SK Insulating Sticks

With M12 thread

In accordance with DIN VDE 0681 Part 2

Type	SSK M12
Part No.	765 005
Material	Steel, plastic-sheathed



## Accessory for IS Insulating Sticks

## Switching Stick Head for IS SQ Insulating Sticks

With T pin shaft (bayonet locking mechanism)

In accordance with DIN VDE 0681 Part 2

T pin shaft in accordance with DIN 48087

Switching stick head is fixed on the insulating stick via the knurled nut

Type	SSK SQ
Part No.	765 009
Material	Polyamide



## SCS Switching Sticks with Silicon Rubber Insulator

Safety Equipment

Nominal voltages up to 123 kV / 50 Hz

Operating Sticks



Switching a disconnector by means of an SCS switching stick

### Easy and safe working

- Cost-effective
- Easy to use



#### General Information:

Standard (switching stick head)	DIN VDE 0681 Part 2
Standard (switching stick)	DIN VDE 0681 Part 1 and Part 2
Standard (insulating stick)	EN/IEC 61243-1 (DIN VDE 0682 Part 411) test for protection against bridging (section 6.3.2) after wet test and leakage current measurement (section 7.1.2)
Standard (operating stick)	DIN VDE 0682 Part 552
Use	Suitable for use in wet weather conditions
For	Indoor and outdoor installations
Design	Fully insulated, massive switching stick head
Material (insulating tube)	Glass-fibre reinforced polyester tube
Material (switching pin)	Steel, sheathed overall in plastic
End fitting	Non-slip plastic cap / plug-in coupling for extending the handle

### Nominal Voltages up to 36 kV

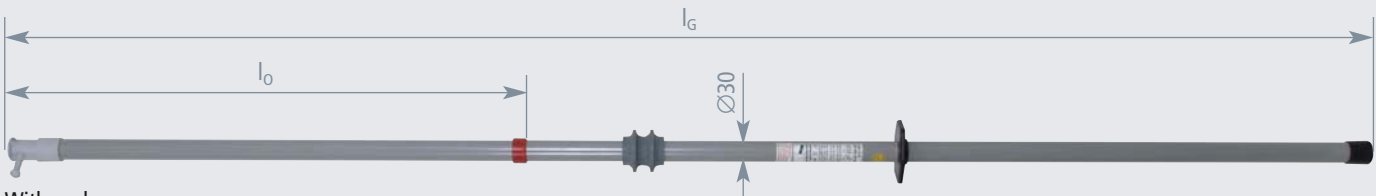

With end cap

Type	SCSN 36 1000	SCSN 36 1500	SCSN 36 2000
Part No.	763 510	763 511	763 512
Nominal voltage (U <sub>N</sub> )	36 kV	36 kV	36 kV
Max. shutter weight	17 kg	17 kg	9 kg
Total length (l <sub>G</sub> )	1030 mm	1500 mm	2000 mm
Insertion depth (l <sub>0</sub> )	135 mm	415 mm	765 mm

### Nominal Voltages up to 36 kV, plug-in Coupling

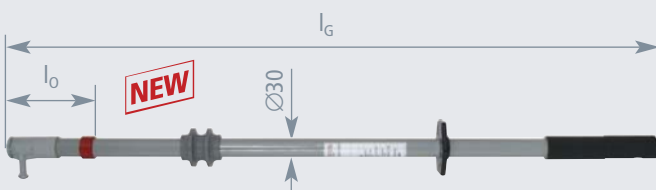

Handle termination with plastic plug-in coupling for extending the handle

Type	SCSN 36 STK 1000
Part No.	763 111
Nominal voltage (U <sub>N</sub> )	36 kV
Max. shutter weight	17 kg
Total length (l <sub>G</sub> )	1000 mm
Insertion depth (l <sub>0</sub> )	135 mm

### Nominal Voltages up to 123 kV, modular

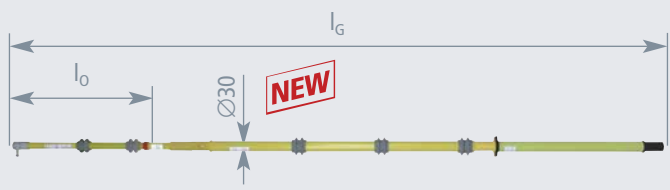

Handle termination with plastic plug-in coupling for extending the handle

Type	SCSN 123 STK 2800
Part No.	763 181
Nominal voltage (U <sub>N</sub> )	123 kV
Total length (l <sub>G</sub> )	2800 mm
Insertion depth (l <sub>0</sub> )	637 mm

## Safety Equipment

## SCS Switching Sticks

## Operating Sticks

Nominal voltages up to 123 kV / 50 Hz

## Easy and safe working

- Cost-effective
- User-friendly



## General Information:

Standard (switching stick head)	DIN VDE 0681 Part 2
Standard (switching stick)	DIN VDE 0681 Part 1 and Part 2
Standard (insulating stick)	DIN VDE 0681 Part 1
Standard (operating stick)	DIN VDE 0682 Part 552
Use	Not suitable for use in wet weather conditions
For	For indoor and outdoor switchgear installations
Design	Fully insulated, massive switching stick head
Material (insulating tube)	Glass-fibre reinforced polyester tube
Material (switching pin)	Steel, sheathed overall in plastic
End fitting	Non-slip plastic cap / plug-in coupling for extending the handle



Switching a disconnector by means of an SCS switching stick

## Nominal Voltages up to 72.5 kV

With end cap

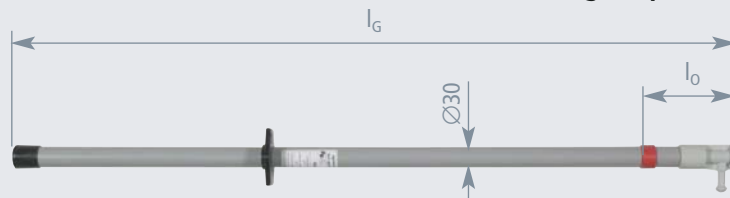

Type	SCS 36 1000	SCS 36 1500	SCS 36 2000	SCS 72 1500	SCS 72 2000
Part No.	763 610	763 611	763 612	763 615	763 620
Nominal voltage (U <sub>N</sub> )	36 kV	36 kV	36 kV	72.5 kV	72.5 kV
Max. shutter weight	17 kg	17 kg	9 kg	—	—
Total length (l <sub>G</sub> )	1030 mm	1500 mm	2000 mm	1500 mm	2000 mm
Insertion depth (l <sub>o</sub> )	135 mm	415 mm	765 mm	290 mm	690 mm

## Nominal Voltages up to 123 kV

Handle termination with plastic plug-in coupling for extending the handle

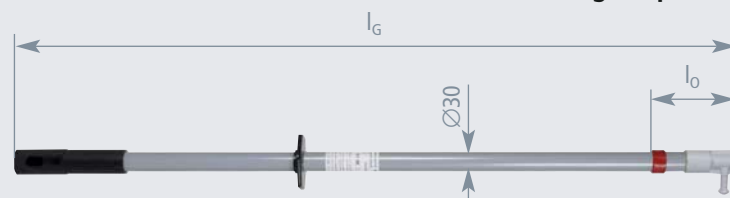

Type	SCS 36 STK 1000	SCS 72 STK 1500	SCS 123 STK 2000
Part No.	763 100	763 150	763 180
Nominal voltage (U <sub>N</sub> )	36 kV	72.5 kV	123 kV
Max. shutter weight	17 kg	—	—
Total length (l <sub>G</sub> )	1000 mm	1500 mm	2000 mm
Insertion depth (l <sub>o</sub> )	135 mm	290 mm	200 mm

Other lengths are available on request.



## SZ Fuse Tongs

Safety Equipment

Nominal voltages up to 36 kV

Operating Sticks



SZ fuse tongs for inserting and removing HH fuses

### Easy and safe working

- User-friendly



### General Information:

Standard	DIN VDE 0681 Part 3
Use	Not suitable for use in wet weather conditions
Design	Straight and 20° angled operating head
Clamping range	Wide clamping range Ø30 ... 90 mm
Material (insulating stick)	Glass-fibre reinforced polyester tube
Material (operating head)	Glass-fibre reinforced polyamide
Material (adjustable handle)	Polyamide
Material (reducing insert)	Polyamide
Colour	Grey

A fuse tong is an operating stick used for working on live parts of an installation with voltages exceeding 1 kV a.c. The operating head is used to remove and insert high-voltage high-breaking-capacity fuses (HH fuses). The clamping jaws are opened and closed by simply turning the adjustable handle.



In practice, the 20° angled operating head allows safe and easy actuation of HH fuses that are not easily accessible.



The reducing insert allows low clamping ranges from Ø30 to 50 mm. Without reducing insert, HH fuses from Ø50 to 90 mm can be actuated.

## Safety Equipment

## SZ Fuse Tong

## Operating Sticks

## Straight SZ Fuse Tong



Type	SZ HH 1060	SZ HH 1250	SZ HH 1500
Part No.	765 040	765 041	765 042
Clamping range	30 ... 50*) / 50 ... 90 mm	30 ... 50*) / 50 ... 90 mm	30 ... 50*) / 50 ... 90 mm
Total length ( $l_G$ )	1060 mm	1250 mm	1500 mm
Insertion depth ( $l_o$ )	185 mm	185 mm	185 mm

\*) Only if used with reducing insert

## 20° angled SZ Fuse Tong

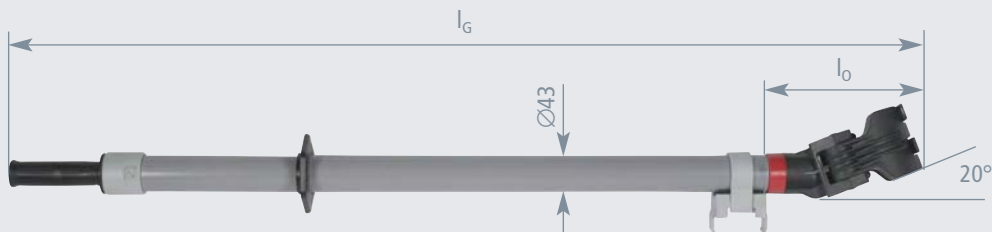

Type	SZ HH W20 1070	SZ HH W20 1250	SZ HH W20 1500
Part No.	765 050	765 051	765 052
Clamping range	30 ... 50*) / 50 ... 90 mm	30 ... 50*) / 50 ... 90 mm	30 ... 50*) / 50 ... 90 mm
Total length ( $l_G$ )	1070 mm	1250 mm	1500 mm
Insertion depth ( $l_o$ )	195 mm	195 mm	195 mm

\*) Only if used with reducing insert

Other lengths are available on request.

## Accessory for SZ Fuse tongs

## Storage Devices for HH Fuses

Wall-mounted

Type	HV 3HH ET
Part No.	700 005
For	HH fuses



## Accessory for SZ Fuse tongs

## Storage Devices for HH Fuses and Fuse Tong

Wall-mounted

Type	HV 3HH SZ ET
Part No.	700 004
For	HH fuses and fuse tong



## Storage Device Kit for HH Fuses or HH fuses and Fuse Tong

Wall-mounted

Type	HV 3HH	HV 3HH SZ
Part No.	700 015	700 014
Consisting of	2x HV 3HH ET	1x HV 3HH ET and 1x HV 3HH ZS ET



**RST Rescue Rods**

Safety Equipment

Nominal voltages up to 36 kV / 50 Hz

Operating Sticks



- For use in indoor and outdoor installations
- Fixed rescue hook (protected against bridging)
- For rescuing persons weighing up to approximately 100 kg from the live working zone in the event of an electrical accident

**General Information:**

Standard	Based on DIN VDE 0681 Part 1
Use	Not suitable for use in wet weather conditions
Material (hook)	PVC-HI solid stick
Material (insulating tube)	Glass-fibre reinforced polyester tube
End fitting	Non-slip plastic cap

Insulated RST rescue rod used to rescue an electrified victim from the live working zone

Nominal voltages up to 36 kV / 50 Hz

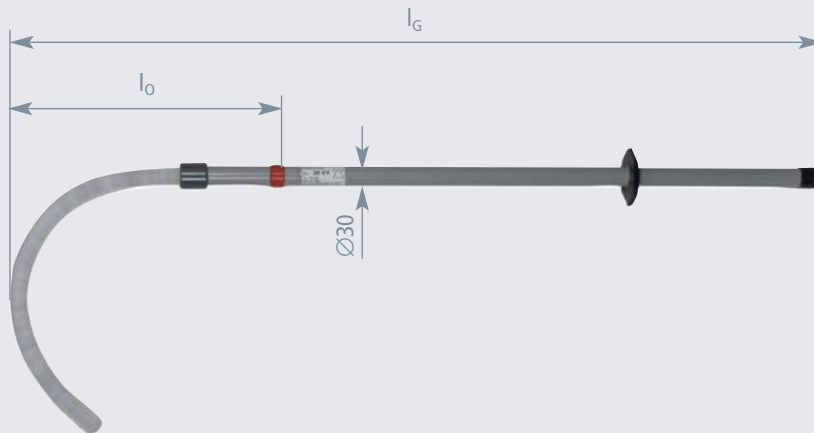

Type	RST 36 1000	RST 36 1500	RST 36 2000
Part No.	766 040	766 041	766 042
Total length ( $l_G$ )	1000 mm	1500 mm	2000 mm
Insertion depth ( $l_0$ )	175 mm	425 mm	775 mm

- Protection against accidental contact with live parts of installations with rated voltages from 1 kV to 36 kV
- Four different designs for use in almost all types of switchgear installations



Inserting an insulating protective shutter (type A1) by hand

**General Information:**

Standard	DIN VDE 0682 Part 552
For	Use in indoor installations only

According to the five safety rules, adjacent parts are parts situated in the vicinity zone. If parts of an installation near the work location cannot be isolated, additional safety measures must be taken before beginning work as is the case with work near live parts.

Insulating protective shutters according to DIN VDE 0682 Part 522 are used to provide protection against accidental contact with live parts of an installation. They are portable and are inserted by hand or by using an operating stick under live conditions.

Insulating protective shutters are designed for short-term use in indoor electrical installations according to DIN VDE 0101 with voltages exceeding 1 kV to 36 kV a.c. at nominal frequencies below 100 Hz to provide protection against direct contact according to DIN VDE 0105 Part 100 when working near live parts.

When used in medium-voltage systems, insulating protective shutters might have to be adapted, for example if it is not possible to insert shutters in the live working zone without risk due to unfavourably located drives, switch components or isolating plates. In such cases, a standard-compliant solution can be found by cutting out parts of the insulating protective shutter or cutting it to size. For that purpose, technical details must be provided. We have developed a special template for insulating protective shutters which can be used, for example, to mark the exact location of the cut-outs.

For enquiries and orders, please fill in the template on pages 66 to 68 or visit our website [www.dehn.de](http://www.dehn.de).

## Example of a Live Working Zone

### Rated voltages from 1 kV to 36 kV

### Insulating Protective Shutters

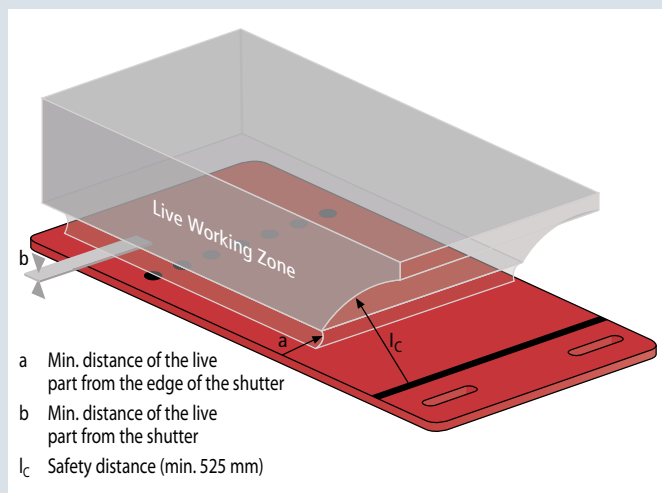

Rated voltage	Minimum distance of the live part	
	from shutter edge a	from shutter b
3.6 kV	60 mm	0 mm
7.2 kV	90 mm	0 mm
12.0 kV	120 mm	20 mm
24.0 kV	220 mm	60 mm
36.0 kV	320 mm	100 mm

Example of a live working zone with an insulating protective shutter of type A1

#### Note

Insulating protective shutters do not protect against reconnection. The protected area is the area which is separated from the area containing live parts by the insulating protective shutter. The minimum distances shown in the above table between shutters / shutter edges and live parts must be observed.

The protective part (with length  $l_s$  and, if required, height  $h_s$ ) of insulating protective shutters is the part that provides protection against accidental contact with live parts. It is fitted with either a handle or a coupling for attaching an operating stick.

Outside the live working zone, the following gaps are permissible between shutter edge and cell wall:

- Up to 10 mm without restriction
- Up to 40 mm, if the distance between the shutter edge and the live working zone is at least 100 mm
- Up to 100 mm near a switch subconstruction



Insulating Protective Shutters

Rated voltages from 1 kV to 36 kV

Due to the various designs of switchgear installations, DIN VDE 0682 Part 552 defines four different basic types of protective shutters:

A1, safety distance provides protection during inserting and removing insulating protective shutters

A2, protective section provides protection during inserting and removing insulating protective shutters

A3, operating stick provides protection during inserting and removing insulating protective shutters

A4, protective device installed on the installation provides protection during inserting and removing insulating protective shutters

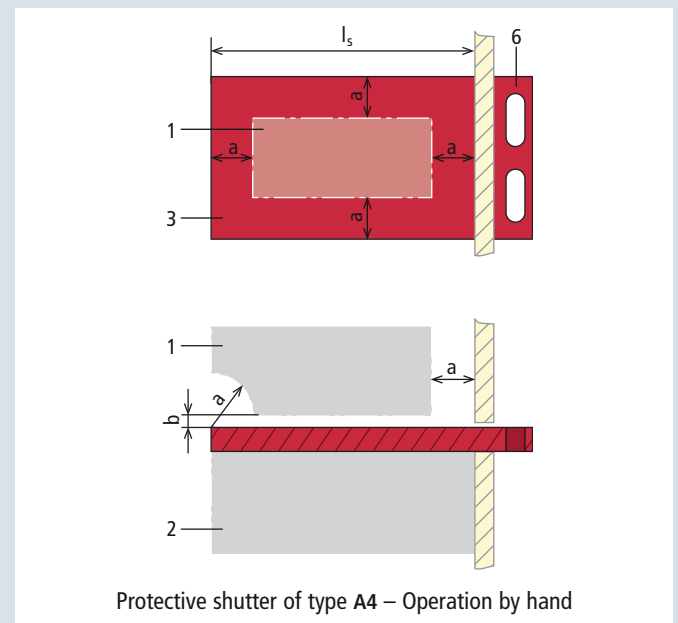
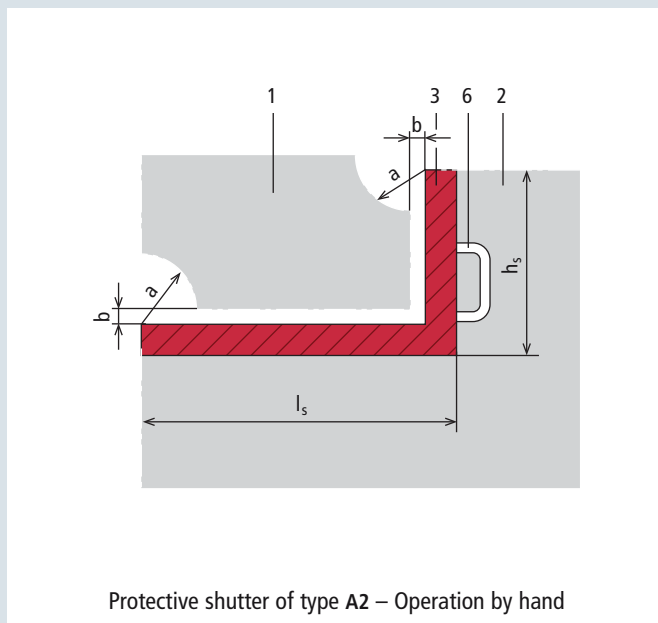
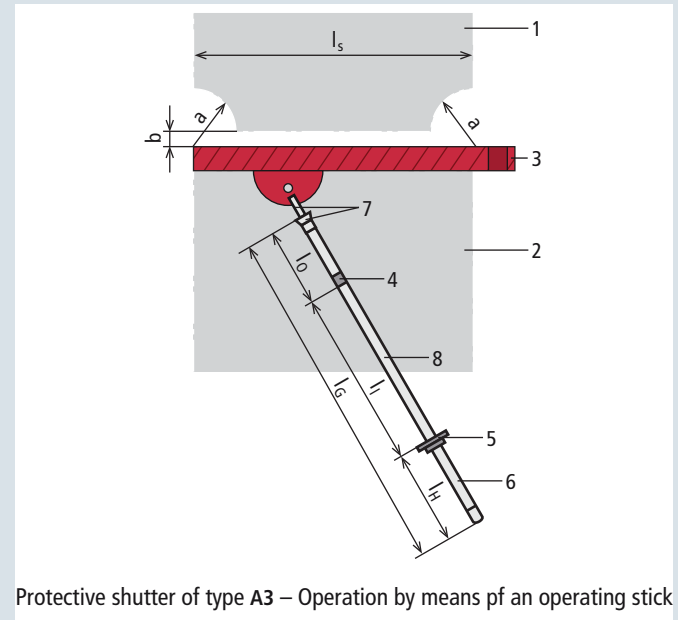
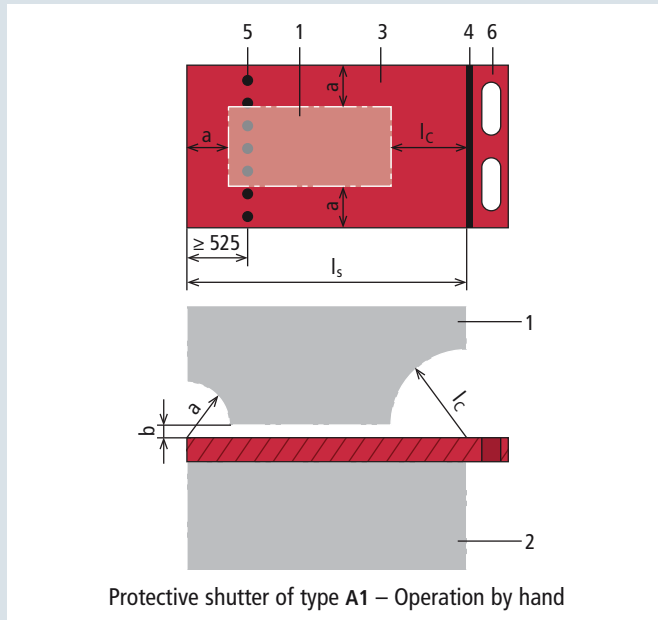

- 1 Live working zone
- 2 Protected area
- 3 Protective section with length  $l_s$  (and height  $h_s$ )
- 4 Limit mark or red ring
- 5 Guide mark / hand guard
- 6 Handle
- 7 Coupling
- 8 Insulating element of the operating stick with length  $l_I$

- $l_G$  Total length of the operating stick
- $l_0$  Length of the top section of the operating stick
- $l_H$  Length of the handle of the operating stick
- $l_I$  Length of the insulating element of the operating stick
- $l_s$  Length of the protective section
- $l_c$  Protection distance

- a Minimum distance of live parts from the edge of the insulating shutter
- b Minimum distance of live parts from the insulating shutter

## Insulating Protective Shutters

### Type A1



Inserting an insulating protective shutter of type A1

### Insulating Protective Shutters

With finger holes, guide and limit mark for inserting and removing insulating protective shutters into / from guide rails by hand.

The guide mark is a dotted line with a minimum distance of 525 mm from the rear shutter edge. The section beyond this mark must not be contacted when inserting the insulating protective shutter.

The limit mark is a continuous line and separates the handle from the protective section. The section beyond this mark must not be contacted when inserting the insulating protective shutter and must be at least 525 mm away from live parts when the shutter has been inserted.

<b>Type</b>	<b>ISP 36 PVC A1...</b>
<b>Part No.</b>	<b>763 211</b>
Rated voltage (U <sub>n</sub> )	Up to 36 kV
Material	Rigid PVC

### Type A2

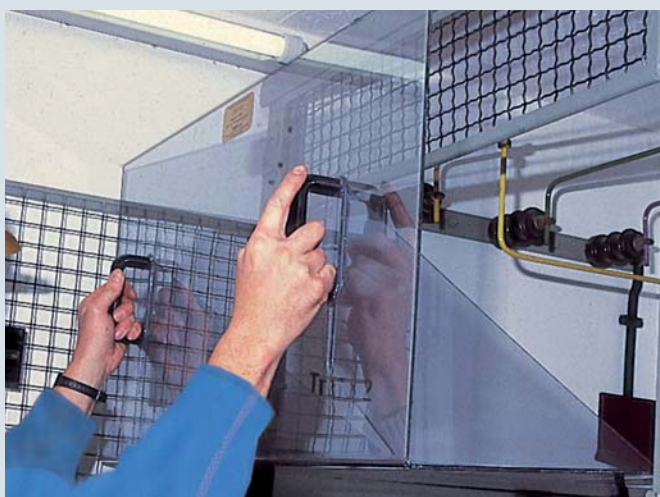

Inserting a transparent insulating protective shutter of type A2

With 90° angled handle and hand grips for inserting or removing insulating protective shutters into / from guide rails by hand. Other angled handles (70° to 270°) are available on request.

The height of the handle has to be selected in such a way that live parts of the installation above the shutter are completely covered.

<b>Type</b>	<b>ISP 36 PVC A2...</b>
<b>Part No.</b>	<b>763 221</b>
Rated voltage (U <sub>n</sub> )	Up to 36 kV
Material	Rigid PVC

Guide rails and other accessories are listed in our template.

Insulating Protective Shutters

Type A3

With retaining device with bayonet pin for inserting and removing insulating protective shutters into / from guide rails using an operating stick.

This shutter type is also available with a longitudinal slot and a retaining device (rotatable shutter). In this case, the shutter is operated using an operating stick with switching stick head.

Two persons are required to insert/remove shutter sizes exceeding 1 m<sup>2</sup>. For this purpose, two retaining devices for attaching operating sticks are required.

Moreover, insulating protective shutters are also available with rolls.



Inserting an insulating protective shutter of type A3

<b>Type</b>	<b>ISP 36 PVC A3...</b>
<b>Part No.</b>	<b>763 231</b>
Rated voltage (U <sub>r</sub> )	Up to 36 kV
Material	Rigid PVC

Operating stick with bayonet coupling and insulating protective shutter with bayonet pin



With finger holes (without additional marks) for use in factory assembled switchgear panels. Instead of finger holes, the shutters are also available with a grip (minimum height: 35 mm).

The shutter is inserted through a slot into the closed installation.

The protective device of the installation must ensure full protection when inserting and removing the shutter.

In type-tested switchgear installations in accordance with DIN VDE 0670 Parts 6 and 7 or EN/IEC 62271-200 (DIN VDE 0671 Part 200), insulating protective shutters may only be used in consultation with the manufacturer of the switchgear installation.

Type A4



Inserting an insulating protective shutter of type A4

<b>Type</b>	<b>ISP 36 PVC A4...</b>
<b>Part No.</b>	<b>763 241</b>
Rated voltage (U <sub>r</sub> )	Up to 36 kV
Material	Rigid PVC

Guide rails and other accessories are listed in our template.

# Template

DEHN form No. 2090/E/0112

Page 1

## Template for Insulating Protective Shutters used in Switchgear Installation with Voltages up to 36 kV

acc. to DIN VDE 0682, Part 552

Material: Rigid PVC

Customer:			
Customer No.:			
Company:			
Address:			
Address, Country:			
Contact:			
Phone / fax:		E-Mail:	
<input type="checkbox"/> Enquiry	<input type="checkbox"/> Order	Quantity:	pc(s) Signature:

1 Switchgear installation:	
Type:	Rated voltage:

ISP	/
for internal use only, please do not fill in	

2 Remark:	
Created / released by:	Signature:
	Date:

3 Recorded by:			
for internal use only, please do not fill in	Name:		
	Date:		
Person in charge:			
Dept.	Name	Date	Remark
Sales			
Purchasing			

4 Confirmation of delivery:	
The protective shutter(s) has/have been delivered to the above mentioned customer according to the information stated in the template on _____ (date).	
This delivery has been subject to random tests in accordance with DIN VDE 0682, Part 552.	
Place, Date	Stamp / Signature

Template for Insulating Protective Shutters used in Switchgear Installation with Voltages up to 36 kV

acc. to DIN VDE 0682, Part 552

Material: Rigid PVC

<b>ISP</b>	/
for internal use only, please do not fill in	

1 Type of insulating protective shutter:		
Thickness:	Type/Application	* Note:
<input type="checkbox"/> 5 mm	<input type="checkbox"/> with finger holes for operation by hand (A1)	Type A4 – when inserting and removing the shutter, the front of the switchgear installation protects the operator from electrical shocks!
<input type="checkbox"/> 6 mm	<input type="checkbox"/> with finger holes for operation by hand (A4*)	
<input type="checkbox"/> _____ mm	<input type="checkbox"/> with 1 bayonet pin for use with an operating stick (A3)	
	<input type="checkbox"/> with 2 bayonet pins for use with an operating stick (A3)	
	<input type="checkbox"/> rotatable shutter for use with an operating stick (A3)	
	<input type="checkbox"/> with handle (A2)	

Colour:	Type / Insertion	Note:
<input type="checkbox"/> red	<input type="checkbox"/> Standard type (can be inserted into guide rails, Part No. 9030)	Two persons are required to insert / remove shutter sizes exceeding 1 m <sup>2</sup> !
<input type="checkbox"/> transparent	<input type="checkbox"/> Rotable shutters (by bearing pin guide)	

2 Dimensions of the insulating protective shutter:					
Dimensions:		A1: 763 211	A2: 763 221	A3: 763 231	A4: 763 241
<b>W</b>	mm				
<b>L</b>	mm				
<b>L<sub>s</sub></b>	mm				
<b>H</b>	mm				
<b>γ</b>	mm				
The angle of the handle can be selected from 70° to 290°.					

Additional sketch for other types



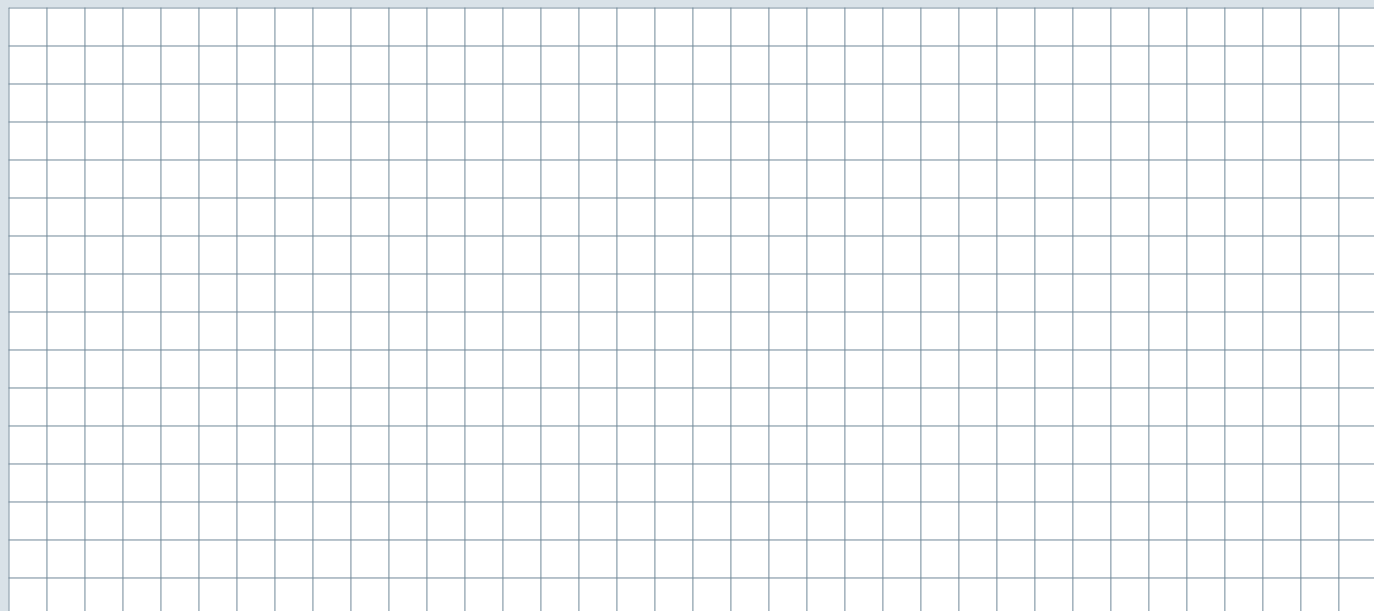

Template







DEHN form No. 2090/E/0112

Page 3

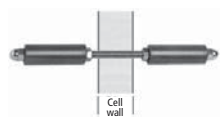
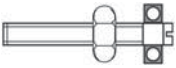
Template for Insulating Protective Shutters used in Switchgear Installation with Voltages up to 36 kV

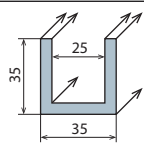
acc. to DIN VDE 0682, Part 552

Material: Rigid PVC

Accessories:			
<input type="checkbox"/> <b>Bayonet pin</b> Part No.: 9040 Quantity: _____ pc(s).		<input type="checkbox"/> <b>Bearing pins</b> Part No.: 9010 Quantity: _____ pc(s).	
<input type="checkbox"/> <b>Ball bearing</b> Part No.: 9041 Quantity: _____ pc(s).		<input type="checkbox"/> <b>Bearing pins</b> Part No.: 9020 Quantity: _____ pc(s).	
<input type="checkbox"/> <b>Handle</b> Part No.: 9050 Quantity: _____ pc(s).		<input type="checkbox"/> <b>Guide rails</b> Part No.: 9030 Quantity: _____ mm	
<input type="checkbox"/> <b>Keyhole</b> Part No.: 9070 Quantity: _____ pc(s).		<input type="checkbox"/> <b>Magnet holder</b> Part No.: 9060 Quantity: _____ pc(s).	
<input type="checkbox"/> <b>45° angled swivelling eye</b> Part No.: 9080 Quantity: _____ pc(s).			

IS insulating stick – T pin shaft

For rotatable shutters with bayonet pin.  
For use as operating stick.

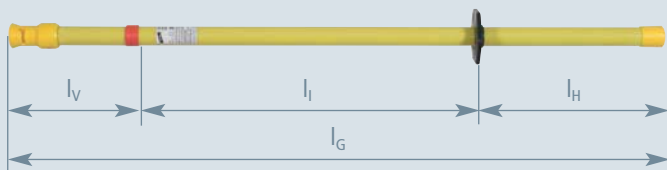

SCS switching stick

For rotatable shutters with longitudinal hole.  
For use as operating stick.

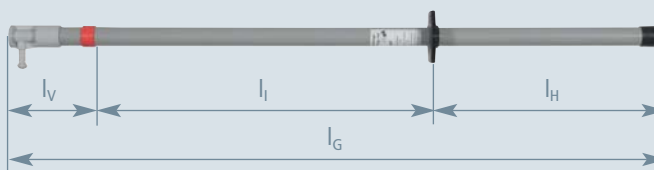

Nominal voltage	$l_G$	$l_i$	$l_H$	$l_v$	Part No. of insulating stick	Part No. of switching stick	Part No. of operating stick kit
up to 36 kV	1028 mm	525 mm	350 mm	140 mm	<input type="checkbox"/> 766 311		
up to 36 kV	1528 mm	525 mm	500 mm	490 mm	<input type="checkbox"/> 766 315		
up to 36 kV	1030 mm	525 mm	370 mm	115 mm		<input type="checkbox"/> 763 610	
up to 36 kV	1500 mm	525 mm	550 mm	395 mm		<input type="checkbox"/> 763 611	
up to 36 kV	2000 mm	525 mm	700 mm	745 mm		<input type="checkbox"/> 763 612	
up to 36 kV		525 mm	560 mm				<input type="checkbox"/> 766 452

## Safety Equipment

## Earthing and Short-Circuiting Devices

## Earthing and Short-Circuiting Devices

Earthing and short-circuiting at the work location is a key element of the five safety rules. This measure ensures that the installation is de-energised when working on electrical equipment even in case of interference voltages, atmospheric surges or accidental reconnection.

Isolation from supply voltage must be verified at the point of installation immediately before portable earthing and short-circuiting equipment is installed.

When installing earthing and short-circuiting devices, the earthing cable always has to be connected to the earthing system first to ensure that residual or interference voltages are discharged.

**Portable earthing and short-circuiting equipment** according to IEC/EN 61230 (DIN VDE 0683 Part 100) is a hand-held device used to approach fixed connection points of parts of an electrical installation for earthing and short-circuiting purposes (according to IEN 50110-1 (DIN VDE 0105 Part 100), section 6.2.4) and for connection with the fixed connection points without guide slots, bushings or guide rails. It consists of an earthing and short-circuiting device (EaS device) and an earthing sticks.

The purpose of **earthing and short-circuiting devices** is to earth and short-circuit electrical conductors. They consist of an earthing and short-circuiting device. The **earthing device** connects the earthing system with a short-circuiting device or with the equipment to be earthed. It consists of an earth clamp (1) and an earthing cable (4).

The short-circuiting device connects the phase conductors that have to be short-circuited. It consists of clamps (1+2), short-circuiting cables or bars (3) and connecting clusters (5), if required.

The **short-circuiting bar** is a rigid short-circuiting device.

**Connecting clusters** connect the short-circuiting cables with each other and with the earthing cable or the short-circuiting bar with the earthing cable.

**Clamps** connect the earthing and short-circuiting cables or bars to the earthing system either directly or via connecting links such as cable lugs and parts of the installation via fixed connection points, if required.

**Fixed connection points** are parts of the installation, to which earthing and short-circuiting devices are connected (e.g. conductors, bars, fixed ball points, cylinder bolts, bows etc.). Maximum short-circuit strength can be achieved by connecting the fixed ball point with the ball head cap of the earthing and short-circuiting device.

An **earthing stick** is a hand-held insulating stick for approaching clamps of earthing and short-circuiting devices to parts of electrical installations for earthing and short-circuiting purposes. It consists of an insulating element, black ring, handle and coupling for attaching clamps. Earthing sticks are selected according to the **weight** of the earthing and short-circuiting devices to be connected (see "max. load on operating head in kg").

The **insulating element** is the part of the earthing stick between the black ring and the end of the earthing stick in the direction of the clamp. It ensures that the user maintains the required safe distance and provides sufficient insulation. The insulating element II must have a minimum length of 500 mm in installations exceeding 1 kV.

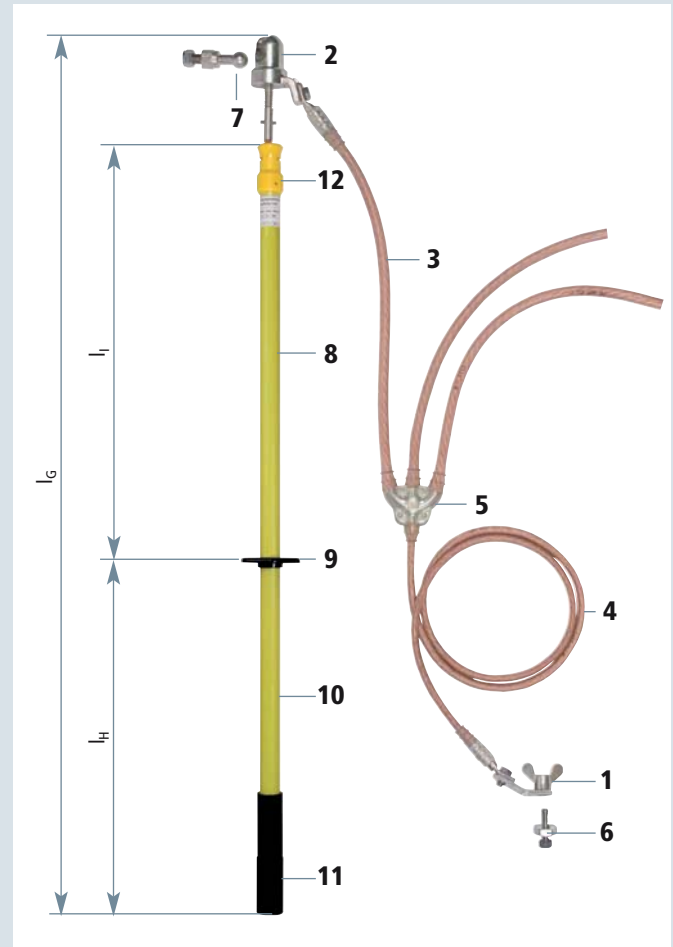

Portable earthing and short-circuiting equipment

- |                          |  |
|--------------------------|--|
| 1 Earth clamp            | 7 Line connection point                |
| 2 Line clamp             | 8 Insulating element with length $I_I$ |
| 3 Short-circuiting cable | 9 Hand guard                           |
| 4 Earthing cable         | 10 Handle with length $I_H$            |
| 5 Connecting cluster     | 11 End fitting with plug-in coupling   |
| 6 Earth connection point | 12 Coupling                            |

A complete earthing and short-circuiting device according to IEC/EN 61230 (DIN VDE 0683 Part 100) includes, for example

- Fixed point / Fixed ball point
- Single-pole or three-pole earthing and short-circuiting device or short-circuiting bar
- Fixed earthing point
- Earthing stick

**Earthing and short-circuiting devices** as well as the fixed ball and earthing points must be rated to withstand the **short-circuit current conditions** expected on site. The required cable cross-section depends on the maximum short-circuit current ( $I_k$  in A) and the maximum short-circuit time ( $T_k$  in s).

## Earthing and Short-Circuiting Devices

Safety Equipment

### Earthing and Short-Circuiting Devices

#### Note:

In the event of a short-circuit, the short-circuit current will flow through the short-circuiting device. However, this is different for earthing devices as they do not conduct short-circuit currents and can therefore be rated for lower values.

#### Cable cross-section:

For short-circuiting cables of our three-pole earthing and short-circuiting devices with cross-sections of 50 mm<sup>2</sup> and higher, the **cross-section of the earthing cable** can be reduced according to the following table.

Cable Cross-Section	
Short-circuiting cable	Earthing cable
16 mm <sup>2</sup>	16 mm <sup>2</sup>
25 mm <sup>2</sup>	25 mm <sup>2</sup>
35 mm <sup>2</sup>	35 mm <sup>2</sup>
50 mm <sup>2</sup>	25 mm <sup>2</sup>
70 mm <sup>2</sup>	35 mm <sup>2</sup>
95 mm <sup>2</sup>	35 mm <sup>2</sup>
120 mm <sup>2</sup>	50 mm <sup>2</sup>
150 mm <sup>2</sup>	50 mm <sup>2</sup>

These earthing and short-circuiting devices with reduced earthing cable cross-sections can be used for all non-solidly earthed neutral systems (e.g. compensated systems with impedance neutral earthing). For **solidly earthed neutral systems**, earthing and short-circuiting cables must have the same cross-sections.

The **current carrying capacity** of the short-circuiting cable and the short-circuiting bar depends on the material, the cross-section (A) and the short-circuit time (T<sub>k</sub>).

Calculations were based on the most critical case, i.e. an off-generator short circuit (μ = 1) and a maximum d.c. components (χ = 1.8) with I<sub>k</sub><sup>''</sup> being the maximum initial short-circuit alternating current, which, according to DIN VDE 0102, is equal to the permanent short-circuit current I<sub>k</sub> and the breaking current I<sub>a</sub>:

$$I_k'' = I_k = I_a$$

The diagrams or the table help to determine the required cable or busbar cross-sections of short-circuiting devices according to the short-circuit current and the short-circuit time of an installation.

### Current carrying capacity of E-Cu F20 short-circuiting bars

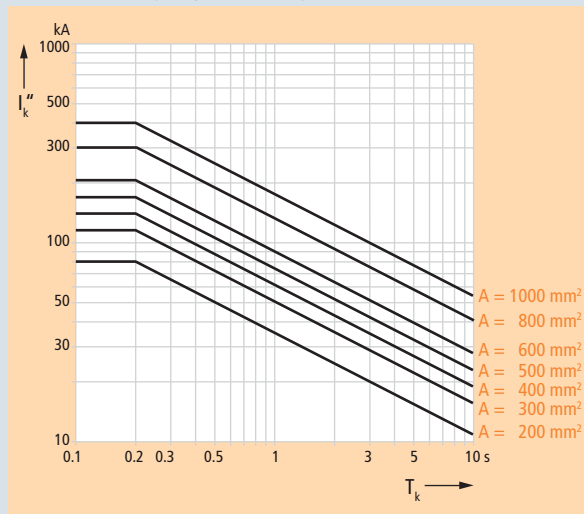

Initial cable temperature 20 °C

Final cable temperature 250 °C

$$A = 5.54 I_k'' \sqrt{T_k} \quad \text{for } T_k \geq 0.2 \text{ s}$$

where:

A Busbars cross-section in mm<sup>2</sup>

I<sub>k</sub><sup>''</sup> Maximum initial short-circuit alternating current in kA according to DIN VDE 0102

T<sub>k</sub> Short-circuit time in s

### Current carrying capacity of E-AlMgSi 0.5 F17 short-circuiting bars

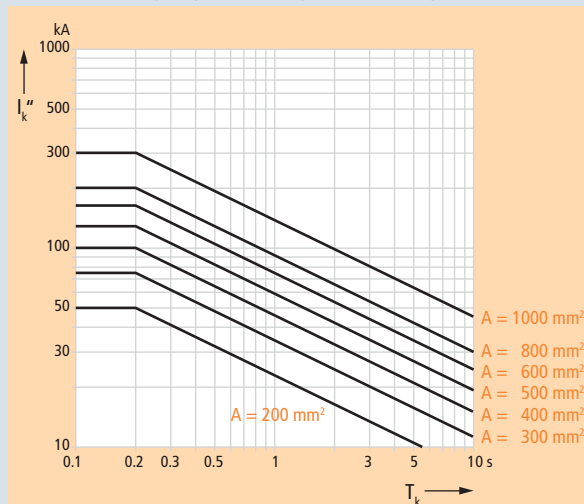

Initial cable temperature 20 °C

Final cable temperature 250 °C

$$A = 8.79 I_k'' \sqrt{T_k} \quad \text{for } T_k \geq 0.2 \text{ s}$$

where:

A Busbars cross-section in mm<sup>2</sup>

I<sub>k</sub><sup>''</sup> Maximum initial short-circuit alternating current in kA according to DIN VDE 0102

T<sub>k</sub> Short-circuit time in s

## Earthing and Short-Circuiting Devices

## Current carrying capacity of copper short-circuiting cables for use in a.c. and three-phase installations

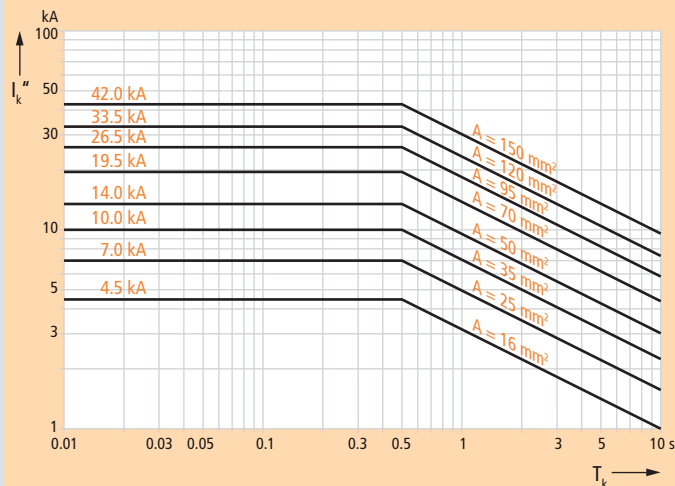

Initial cable temperature 20 °C

Final cable temperature 250 °C

$$A = 5.07 I_k'' \sqrt{T_k} \quad \text{for } T_k \geq 0.5 \text{ s}$$

where:

A Cable cross-section in mm<sup>2</sup>I<sub>k</sub>'' Maximum initial short-circuit alternating current in kA according to DIN VDE 0102T<sub>k</sub> Short-circuit time in s

## Current carrying capacity of copper short-circuiting cables for use in d.c. installations

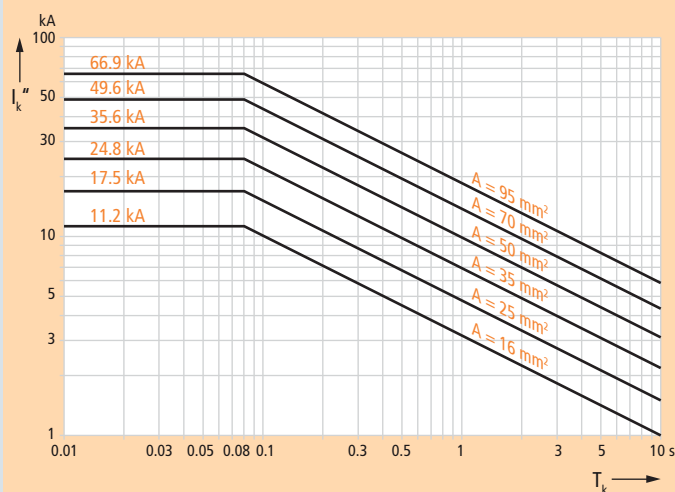

Initial cable temperature 20 °C

Final cable temperature 250 °C

$$A = 5.07 I_k'' \sqrt{T_k} \quad \text{for } T_k \geq 0.08 \text{ s}$$

where:

A Cable cross-section in mm<sup>2</sup>I<sub>k</sub>'' Maximum initial short-circuit alternating current in kA according to DIN VDE 0102T<sub>k</sub> Short-circuit time in s

## Current carrying capacity of copper short-circuiting cables for use on overhead contact lines of electric railways

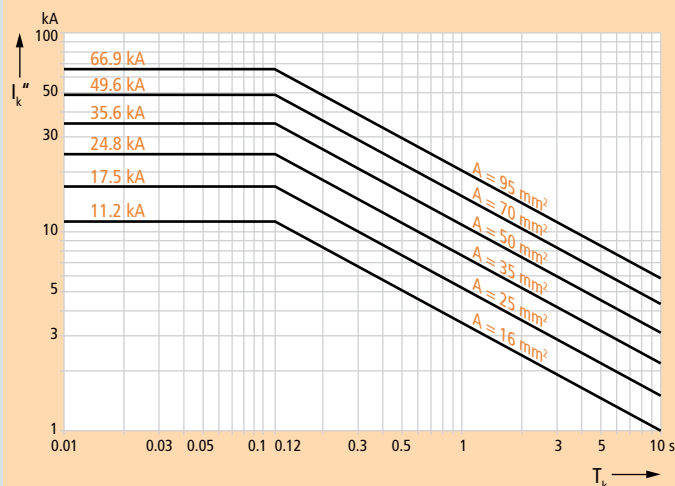

Initial cable temperature 20 °C

Final cable temperature 400 °C

$$A = 4.1 I_k'' \sqrt{T_k} \quad \text{for } T_k \geq 0.12 \text{ s}$$

where:

A Cable cross-section in mm<sup>2</sup>I<sub>k</sub>'' Maximum initial short-circuit alternating current in kA according to DIN VDE 0102T<sub>k</sub> Short-circuit time in s

**Calculation example:**

Known: Mains breaking capacity  $S_a$   
Short-circuit time  $T_k$

Unknown: Required cable or bar cross-section  $A$ .

The calculation is based on an off-generator short-circuit.

$$\text{Three-phase current } I_k'' = I_k = I_a = \frac{S_a}{\sqrt{3} \cdot U_N}$$

$$\text{Single-phase a.c. current } I_k'' = I_k = I_a = \frac{S_a}{U_N}$$

The required cable or bar cross-section can now be calculated based on  $I_k''$ , of the above equations or can be taken from the diagrams. The permissible current carrying capacity of an earthing and short-circuiting device is based on the cross-section printed on the short-circuiting cables or bars.

**Notes:**

- Earthing and short-circuiting devices can only be loaded once with the permissible short-circuit currents depending on the short-circuit time.
- Short-circuiting cables of multi-pole earthing and short-circuiting devices must have the same cross-sections.
- Cable lengths of earthing and short-circuiting devices should be as short as possible as the cables move violently during a short-circuit. They should be at least 120% of the distance between two fixed connection points.
- When connecting earthing and short-circuiting devices in parallel with cables for achieving certain total cable cross-sections, the following conditions must be fulfilled:
  1. Identical cable lengths and cross-sections,
  2. Identical clamps and fixed connection points,
  3. Installing the devices directly next to each other, with parallel arrangement of cables,
  4. The current carrying capacity per cable must be reduced to 75% of the current carrying capacity of the cable cross-section.

**Remark:**

If it is ensured that earthing and short-circuiting devices connected in parallel are loaded with short-circuit currents only once (no interruption of the short circuit), the devices may be exposed to the full load. Generally, this applies to installations with nominal voltages above 110 kV.

**Table:**

Cable cross-section of the earthing and short-circuiting device depending on the maximum short-circuit  $I_k$  and maximum short-circuit time  $T_k$

Cross-section of the copper cable	Max. short-circuit current $I_k$ at a duration of				
	10 s	5 s	2 s	1 s *)	≤ 0.5 s *)
16 mm <sup>2</sup>	1 000 A	1 400 A	2 200 A	3 200 A	4 500 A
25 mm <sup>2</sup>	1 600 A	2 200 A	3 500 A	4 900 A	7 000 A
35 mm <sup>2</sup>	2 200 A	3 100 A	4 900 A	6 900 A	10 000 A
50 mm <sup>2</sup>	3 100 A	4 400 A	7 000 A	9 900 A	14 000 A
70 mm <sup>2</sup>	4 400 A	6 200 A	9 800 A	13 800 A	19 500 A
95 mm <sup>2</sup>	5 900 A	8 400 A	13 200 A	18 700 A	26 500 A
120 mm <sup>2</sup>	7 500 A	10 600 A	16 700 A	23 700 A	33 500 A
150 mm <sup>2</sup>	9 400 A	13 200 A	20 900 A	29 600 A	42 000 A

\*) catalogue data



## Earthing and Short-Circuiting Devices

- A suitable earthing and short-circuiting device can be easily selected online
- Unique laser printing on the earthing and short-circuiting device
- Individual configuration
- Permanent plausibility check in the background
- User-friendly interface
- To start the configuration, simply enter the Variant No., Part No. or product configuration

**EaS Configurator:**  
[www.dehn.de/en/euk](http://www.dehn.de/en/euk)

With the help of the earthing and short-circuiting configurator, customised earthing and short-circuiting (EaS) devices for switchgear installations and overhead lines can be individually configured online at [www.dehn.de/en/euk](http://www.dehn.de/en/euk).

The configurator provides you with two options to begin with the configuration (product or system view).

The product view is ideally suited for users who know exactly what they need and already have a concrete idea of, for example, the cable cross-section and clamps to be used.

As an alternative, the system view can be selected. For this extended version of the product view, information on the installation must be provided.

The place of use (switchgear installation or overhead line) of the earthing and short-circuiting device is decisive for the selection of the clamps.

A permanent plausibility check ensures reliable selection of the right device. Further accessory such as earthing sticks is optionally displayed for the configured earthing and short-circuiting devices.

At the end of the configuration the result is graphically shown and a detailed description of the earthing and short-circuiting device is provided. Moreover, a unique variant No. is assigned to the application-specific earthing and short-circuiting device, which will be lasered on the device later.



You will find the earthing and short-circuiting configurator and a demo version at [www.dehn.de/en/euk](http://www.dehn.de/en/euk)

**Note:**

If you have no internet access, please fill in the template on page 109 and send it to us!



The earthing and short-circuiting configurator is graphically divided into three parts:

- On the left side a tree structure of the given information is displayed. You can return to the history and change already selected information at any time. The tree structure allows a clearly structured configuration.
- In the centre you may select or change the required information via the keyboard or the mouse. This is done step by step meaning that a detail must be provided before the next detail is visible and selectable.
- On the right side the current state is graphically displayed to ensure and facilitate optimal selection. Moreover, data may be entered in the relevant field.

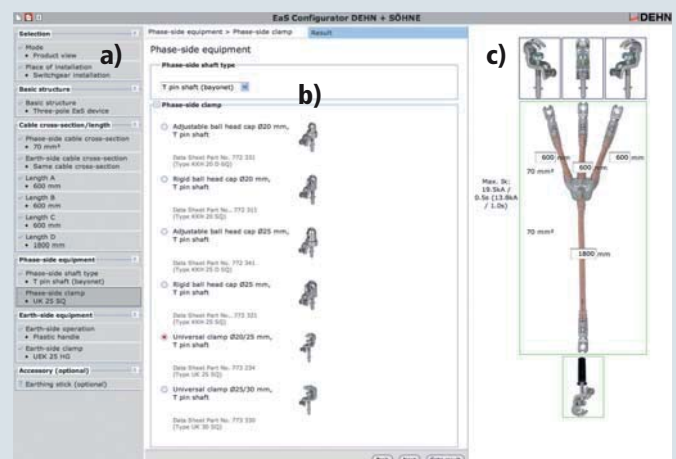

## Earthing and Short-Circuiting Device in eight Steps with the Earthing and Short-Circuiting Configurator

Safety Equipment

Earthing and Short-Circuiting Devices

### 1. Selection mode

First select

- a. **Product view** or
- b. **System view.**

If you already know which cable cross-section and clamps are to be used, select the product view.

In the system view the parameters of the switchgear installation are entered, for example the maximum short-circuit current and the type of earthing. Whether product or system view – both solutions lead to a technically sound earthing and short-circuiting device.

### 2. Basic structure

Define the basic **structure** of the earthing and short-circuiting device.

### 3. Phase cable end cross-section

Select the **phase cable end cross-section** of the short-circuiting cables.

### 4. Earth cable end cross-section

Decide whether the **earth cable end** should have the same cable cross-section or a reduced cable cross-section.

### 5. Phase cable end equipment

Select the **shaft type** and **connection element** to be used for the phase cable end.

### 6. Earth cable end equipment

Select the **type of operation** and **connection element** to be used for the earth cable end.

### 7. Earthing stick

Optional earthing sticks are available as **accessory** in different lengths and versions.

### 8. PDF of your selection

You can send the configured **result** via e-mail, add it to the DEHN + SÖHNE shopping cart or created a pdf file of the result.

#### Note:

If you have no internet access, please fill in the template on page 109 and send it to us!

**EaS Configurator:**  
[www.dehn.de/en/euk](http://www.dehn.de/en/euk)



## Safety Equipment

## Selection Guide

## Earthing and Short-Circuiting Devices

Components	Type	Page	
Fixed Points		76	
Short-circuiting Bars	Template	84	 <i>EaS Configurator: www.dehn.de/en/euk</i>
Earthing and Short-circuiting Cables	one- to five-pole	87	
Phase Connecting Elements	for Switchgear Installations	90	
	for Overhead Lines	92	
Earth Connecting Elements	Earthing Kit	97	
		98	
Earthing Sticks	for Switchgear Installations (single- and two-part)	102	
	for Overhead Lines (telescopic and multi-part)	105	
Template		109	 <i>EaS Configurator: www.dehn.de/en/euk</i>
Easy Choice		110	
Storage Bags and Transport Cases	Sheet metal or plastic case Artificial leather or canvas bag	187	

## Fixed Ball Points

Safety Equipment

Ø20 or 25 mm

Fixed Phase and Earthing Points



Straight fixed ball point mounted on a busbar

- Suitable for fixing cable lugs or connecting busbars in accordance with DIN 43673 Part 1
- Self-locking nut
- M12 or M16 female thread (not cut)
- M12 or M16 threaded pin

### General Information:

Standard	EN/IEC 61230 (DIN VDE 0683 Part 100) and DIN 48088 Part 1
Material (fixed ball point)	E-Cu/gal Sn
Material (threaded pin)	StSt A2-70
Hexagon nut	DIN 985-M12-8 / gal Zn; DIN 985-M16-8 / gal Zn
Tightening torque	M12: 80 Nm; M16: 150 Nm



Angled fixed ball point

## Angled with Terminal Lug



Type	KFP 20 S AL 12	KFP 25 S AL 12
Part No.	706 300	756 300
Fixed ball point Ø	20 mm	25 mm
Dimensions	45 x 30 x 9 mm	50 x 30 x 9 mm
Max. cable cross-section	50 mm <sup>2</sup>	95 mm <sup>2</sup>
Max. short-circuit current I <sub>k</sub> 0.5 s	14 kA	26.5 kA
Max. short-circuit current I <sub>k</sub> 1 s	9.9 kA	18.7 kA

## Safety Equipment

## Fixed Ball Points

## Fixed Phase and Earthing Points

## Straight with threaded Pin and Nut



Type	KFP 20 M12 35 SSM	KFP 20 M16 45 SSM	KFP 25 M12 25 SSM	KFP 25 M12 45 SSM	KFP 25 M16 45 SSM
<b>Part No.</b>	<b>754 235</b>	<b>754 645</b>	<b>755 225</b>	<b>755 245</b>	<b>755 645</b>
Fixed ball point Ø	20 mm	20 mm	25 mm	25 mm	25 mm
Dimensions	M12 x 35 mm	M16 x 45 mm	M12 x 25 mm	M12 x 45 mm	M16 x 45 mm
Width A/F	24 mm	24 mm	27 mm	27 mm	27 mm
Max. cable cross-section	120 mm <sup>2</sup>	120 mm <sup>2</sup>	150 mm <sup>2</sup>	150 mm <sup>2</sup>	150 mm <sup>2</sup>
Max. short-circuit current I <sub>k</sub> 0.5 s	33.5 kA	33.5 kA	42.0 kA	42.0 kA	42.0 kA
Max. short-circuit current I <sub>k</sub> 1 s	23.7 kA	23.7 kA	29.6 kA	29.6 kA	29.6 kA

## Straight with female Thread



Type	KFP 20 M12	KFP 20 M16	KFP 25 M12	KFP 25 M16
<b>Part No.</b>	<b>754 200</b>	<b>754 600</b>	<b>755 200</b>	<b>755 600</b>
Fixed ball point Ø	20 mm	20 mm	25 mm	25 mm
Dimensions	M12 mm	M16 mm	M12 mm	M16 mm
Width A/F	24 mm	24 mm	27 mm	27 mm
Max. cable cross-section	120 mm <sup>2</sup>	120 mm <sup>2</sup>	150 mm <sup>2</sup>	150 mm <sup>2</sup>
Max. short-circuit current I <sub>k</sub> 0.5 s	33.5 kA	33.5 kA	42.0 kA	42.0 kA
Max. short-circuit current I <sub>k</sub> 1 s	23.7 kA	23.7 kA	29.6 kA	29.6 kA

## 45° angled with threaded Pin and Nut



Type	KFP 20 W45 M12 35SSM	KFP 20 W45 M16 45SSM	KFP 25 W45 M12 45SSM	KFP 25 W45 M16 45SSM
<b>Part No.</b>	<b>706 235</b>	<b>706 645</b>	<b>756 245</b>	<b>756 645</b>
Fixed ball point Ø	20 mm	20 mm	25 mm	25 mm
Dimensions	M12 x 35 mm	M16 x 45 mm	M12 x 45 mm	M16 x 45 mm
Width A/F	24 mm	24 mm	27 mm	27 mm
Max. cable cross-section	70 mm <sup>2</sup>	70 mm <sup>2</sup>	95 mm <sup>2</sup>	95 mm <sup>2</sup>
Max. short-circuit current I <sub>k</sub> 0.5 s	19.5 kA	19.5 kA	26.5 kA	26.5 kA
Max. short-circuit current I <sub>k</sub> 1 s	13.8 kA	13.8 kA	18.7 kA	18.7 kA

Other threaded pin lengths are available on request.



## Fixed Ball Points

Safety Equipment

## 45° angled with female Thread

Fixed Phase and Earthing Points



Type	KFP 20 W45 M12	KFP 20 W45 M16	KFP 25 W45 M12	KFP 25 W45 M16
<b>Part No.</b>	<b>706 200</b>	<b>706 600</b>	<b>756 200</b>	<b>756 600</b>
Fixed ball point Ø	20 mm	20 mm	25 mm	25 mm
Dimensions	M12 mm	M16 mm	M12 mm	M16 mm
Width A/F	24 mm	24 mm	27 mm	27 mm
Max. cable cross-section	70 mm <sup>2</sup>	70 mm <sup>2</sup>	95 mm <sup>2</sup>	95 mm <sup>2</sup>
Max. short-circuit current I <sub>k</sub> 0.5 s	19.5 kA	19.5 kA	26.5 kA	26.5 kA
Max. short-circuit current I <sub>k</sub> 1 s	13.8 kA	13.8 kA	18.7 kA	18.7 kA

## 90° angled with threaded Pin and Nut



Type	KFP 20 W90 M12 35SSM	KFP 20 W90 M16 45SSM	KFP 25 W90 M12 45SSM	KFP 25 W90 M16 45SSM
<b>Part No.</b>	<b>707 235</b>	<b>707 645</b>	<b>757 245</b>	<b>757 645</b>
Fixed ball point Ø	20 mm	20 mm	25 mm	25 mm
Dimensions	M12 x 35 mm	M16 x 45 mm	M12 x 45 mm	M16 x 45 mm
Width A/F	24 mm	24 mm	27 mm	27 mm
Max. cable cross-section	70 mm <sup>2</sup>	70 mm <sup>2</sup>	95 mm <sup>2</sup>	95 mm <sup>2</sup>
Max. short-circuit current I <sub>k</sub> 0.5 s	19.5 kA	19.5 kA	26.5 kA	26.5 kA
Max. short-circuit current I <sub>k</sub> 1 s	13.8 kA	13.8 kA	18.7 kA	18.7 kA

## 90° angled with female Thread



Type	KFP 20 W90 M12	KFP 20 W90 M16	KFP 25 W90 M12	KFP 25 W90 M16
<b>Part No.</b>	<b>707 200</b>	<b>707 600</b>	<b>757 200</b>	<b>757 600</b>
Fixed ball point Ø	20 mm	20 mm	25 mm	25 mm
Dimensions	M12 mm	M16 mm	M12 mm	M16 mm
Width A/F	24 mm	24 mm	27 mm	27 mm
Max. cable cross-section	70 mm <sup>2</sup>	70 mm <sup>2</sup>	95 mm <sup>2</sup>	95 mm <sup>2</sup>
Max. short-circuit current I <sub>k</sub> 0.5 s	19.5 kA	19.5 kA	26.5 kA	26.5 kA
Max. short-circuit current I <sub>k</sub> 1 s	13.8 kA	13.8 kA	18.7 kA	18.7 kA

Other threaded pin lengths are available on request.

## Safety Equipment

## Fixed Ball Points for round Conductors

## Fixed Phase and Earthing Points

Ø20 or 25 mm

- To be mounted on round copper conductors
- Stainless steel fixing bolts



Fixed ball point attached to the round copper conductor of a switchgear installation

## General Information:

Standard EN/IEC 61230 (DIN VDE 0683 Part 100)

## Ball (Ø20 mm) for round Conductors (Ø10 – 20 mm)

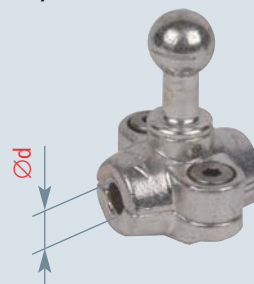

Type	KFP 20 RL 10	KFP 20 RL 12	KFP 20 RL 14	KFP 20 RL 16	KFP 20 RL 18	KFP 20 RL 20
Part No.	720 010	720 012	720 014	720 016	720 018	720 020
Fixed ball point Ø	20 mm	20 mm	20 mm	20 mm	20 mm	20 mm
For round conductor Ø d	10 mm	12 mm	14 mm	16 mm	18 mm	20 mm
Max. cable cross-section	50 mm <sup>2</sup>	50 mm <sup>2</sup>	50 mm <sup>2</sup>	50 mm <sup>2</sup>	50 mm <sup>2</sup>	50 mm <sup>2</sup>
Max. short-circuit current I <sub>k</sub> 0.5 s	14 kA	14 kA	14 kA	14 kA	14 kA	14 kA
Max. short-circuit current I <sub>k</sub> 1 s	9.9 kA	9.9 kA	9.9 kA	9.9 kA	9.9 kA	9.9 kA

## Ball (Ø25 mm) for round Conductors (Ø10 – 20 mm)

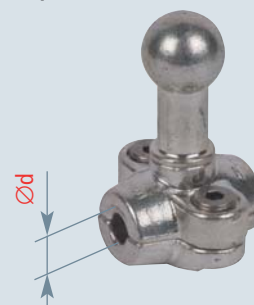

Type	KFP 25 RL 10	KFP 25 RL 12	KFP 25 RL 14	KFP 25 RL 16	KFP 25 RL 18	KFP 25 RL 20
Part No.	725 010	725 012	725 014	725 016	725 018	725 020
Fixed ball point Ø	25 mm	25 mm	25 mm	25 mm	25 mm	25 mm
For round conductor Ø d	10 mm	12 mm	14 mm	16 mm	18 mm	20 mm
Max. cable cross-section	95 mm <sup>2</sup>	95 mm <sup>2</sup>	95 mm <sup>2</sup>	95 mm <sup>2</sup>	95 mm <sup>2</sup>	95 mm <sup>2</sup>
Max. short-circuit current I <sub>k</sub> 0.5 s	26.5 kA	26.5 kA	26.5 kA	26.5 kA	26.5 kA	26.5 kA
Max. short-circuit current I <sub>k</sub> 1 s	18.7 kA	18.7 kA	18.7 kA	18.7 kA	18.7 kA	18.7 kA

Fixed ball points for round conductors with other diameters are available on request.

Note: Conductor diameter d to be specified at order!

## Fixed Earthing Points with Ring Groove

Safety Equipment

### Ring groove (Ø16 mm)

Fixed Phase and Earthing Points



Fixed earthing point with ring groove and earth bushing

- For connecting earth bushings or earth connecting plates in accordance with DIN 48088 Part 2
- Self-locking nut
- M12 or M16 female thread (not cut)
- M12 or M16 threaded pin

#### General Information:

Standard	EN/IEC 61230 (DIN VDE 0683 Part 100) and DIN 48088 Part 2
Material (fixed point)	Brass (CuNi2Si) / gal Sn
Material (threaded pin)	StSt A2-70
Hexagon nut	DIN 985-M12-8 / gal Zn; DIN 985-M16-8 / gal Zn
Tightening torque	M12: 80 Nm; M16: 150 Nm

### Ring Groove (Ø16 mm) with threaded Pin and Nut



Type	EFP 16 RN M12 35 SSM	EFP 16 RN M16 45 SSM
Part No.	790 251	790 261
Dimensions	M12 x 35 mm	M16 x 45 mm
Width A/F	22 mm	22 mm
Max. cable cross-section	150 mm <sup>2</sup>	150 mm <sup>2</sup>
Max. short-circuit current I <sub>k</sub> 0.5 s	42 <sup>1)</sup> kA	42 <sup>1)</sup> kA
Max. short-circuit current I <sub>k</sub> 1 s	29.6 <sup>1)</sup> kA	29.6 <sup>1)</sup> kA

### Ring Groove (Ø16 mm) with female Thread



Type	EFP 16 RN M12	EFP 16 RN M16
Part No.	790 250	790 260
Dimensions	M12 mm	M16 mm
Width A/F	22 mm	22 mm
Max. cable cross-section	150 mm <sup>2</sup>	150 mm <sup>2</sup>
Max. short-circuit current I <sub>k</sub> 0.5 s	42 <sup>1)</sup> kA	42 <sup>1)</sup> kA
Max. short-circuit current I <sub>k</sub> 1 s	29.6 <sup>1)</sup> kA	29.6 <sup>1)</sup> kA

<sup>1)</sup> For earthing and short-circuiting devices with cable lengths > 4000 mm: 26.5 kA / 0.5 s (18.7 kA / 1 s)

## Safety Equipment

## Fixed Earthing Points

## Fixed Phase and Earthing Points

## Connectors

- For welding or screwing earth connectors with wing nut or wing bolt
- Connectors with M12 or M16 threaded pin
- M12 or M16 female thread

## General Information:

Standard	EN/IEC 61230 (DIN VDE 0683 Part 100) and DIN 48088 Part 5
----------	---



Earth connector with M12 threaded pin screwed to an earthed part of an installation

## Welding-type Connector with threaded Pin



Type	AS SCHW M12 25	AS SCHW M16 30
Part No.	705 501	755 501
Dimensions	M12 x 25 mm	M16 x 30 mm
Material	St/gal Zn	St/gal Zn
Max. cable cross-section	150 mm <sup>2</sup>	150 mm <sup>2</sup>
Max. short-circuit current $I_k$ 0.5 s	42 kA	42 kA
Max. short-circuit current $I_k$ 1 s	29.6 kA	29.6 kA

## Welding-type Connector with female Thread



Type	AS SCHW M12	AS SCHW M16
Part No.	336 020	336 025
Dimensions	M12 mm	M16 mm
Material	St/gal Zn	St/gal Zn
Max. cable cross-section	150 mm <sup>2</sup>	150 mm <sup>2</sup>
Max. short-circuit current $I_k$ 0.5 s	42 kA	42 kA
Max. short-circuit current $I_k$ 1 s	29.6 kA	29.6 kA

## Bolted-type Connector with female Thread



Type	AS SCHR M12 M12 40
Part No.	705 504
Dimensions	M12 / M12 x 40 mm
Width A/F	27 mm
Material	Copper alloy/gal Sn
Max. cable cross-section	150 mm <sup>2</sup>
Max. short-circuit current $I_k$ 0.5 s	42 kA
Max. short-circuit current $I_k$ 1 s	29.6 kA

## Bolted-type Connector with threaded Pin and separate hexagon Nut



Type	AS SCHR M12 55	AS SCHR M16 65
Part No.	705 500	750 500
Dimensions	M12 x 55 mm	M16 x 65 mm
Width A/F	32 mm	41 mm
Material (threaded pin)	StSt	StSt
Material (nut)	Copper alloy/gal Sn / St/tZn	Copper alloy/gal Sn / St/tZn
Max. cable cross-section	150 mm <sup>2</sup>	150 mm <sup>2</sup>
Max. short-circuit current $I_k$ 0.5 s	42 kA	42 kA
Max. short-circuit current $I_k$ 1 s	29.6 kA	29.6 kA

## Bolted-type Connector for converting from M12 to M16 threaded Pin



Type	AS SCHR M16 55 M12
Part No.	705 510
Dimensions	M12 x 20 / M16 x 55 mm
Width A/F	41 mm
Material (threaded pin)	StSt
Material (nut)	Copper alloy/gal Sn
Max. cable cross-section	150 mm <sup>2</sup>
Max. short-circuit current $I_k$ 0.5 s	42 kA
Max. short-circuit current $I_k$ 1 s	29.6 kA

## Earth Connecting Plates

Safety Equipment

Fixed Phase and Earthing Points



Earth connecting plate with fixed ball points and ball head cap with plastic handle

- For indoor and outdoor installations
- Connecting plate with high short-circuit carrying capacity
- Allows for connection of the short-circuiting cables (single-pole)
- For fixed ball points Ø20 mm, Ø25 mm or ring groove bolts Ø16 mm

### General Information:

Standard	EN/IEC 61230 (DIN VDE 0683 Part 100) and fixed points in accordance with DIN 48088 Part 1
Material (fixed point)	E-Cu / brass (CuNi2Si) / gal Sn
Material (threaded pin)	StSt A2-70
Hexagon nut	DIN 985-M12-8 / gal Zn; DIN 985-M16-8 / gal Zn

### With Ball Head Cap and three fixed Ball Points

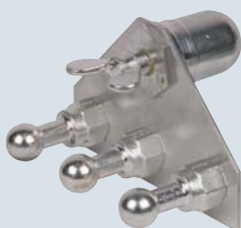

Type	EAP 3 KFP 20 KKH	EAP 3 KFP 25 KKH
Part No.	728 300	728 500
Fixed point Ø	20 mm	25 mm
Max. cable cross-section	120 mm <sup>2</sup>	150 mm <sup>2</sup>
Max. short-circuit current I <sub>k</sub> 0.5 s	33.5 kA	42.0 kA
Max. short-circuit current I <sub>k</sub> 1 s	23.7 kA	29.6 kA

### With three fixed Ball Points



To be mounted on earth connecting clamps with protection against twisting (PK1)

Type	EAP 3 KFP 20 B13	EAP 3 KFP 25 B13
Part No.	728 320	728 325
Fixed point Ø	20 mm	25 mm
Max. cable cross-section	120 mm <sup>2</sup>	150 mm <sup>2</sup>
Max. short-circuit current I <sub>k</sub> 0.5 s	33.5 kA	42.0 kA
Max. short-circuit current I <sub>k</sub> 1 s	23.7 kA	29.6 kA

### With Earth Bushing and three fixed Earthing Points with Ring Groove



Type	EAP 3 RN 16 EAB
Part No.	728 520
Fixed point Ø	16 mm
Max. cable cross-section	95 mm <sup>2</sup>
Max. short-circuit current I <sub>k</sub> 0.5 s	26.5 kA
Max. short-circuit current I <sub>k</sub> 1 s	18.7 kA

### With three fixed Earthing Points with Ring Groove



To be mounted on earth connecting clamps with protection against twisting (PK1)

Type	EAP 3 RN 16 B13
Part No.	728 316
Fixed point Ø	16 mm
Max. cable cross-section	95 mm <sup>2</sup>
Max. short-circuit current I <sub>k</sub> 0.5 s	26.5 kA
Max. short-circuit current I <sub>k</sub> 1 s	18.7 kA



## Fixed Phase and Earthing Points

- Coupling aid (clamp) for phase screw clamps
- For high-voltage installations up to 220 kV
- Other types of clamps, e.g. for twin conductors or greater clamp widths available on request



Fixed phase point mounted on an overhead line conductor

**General Information:**

Standard	Clamp in accordance with DIN 48088 Part 3
Clamp material	Aluminium / copper alloy
Bolt material	StSt

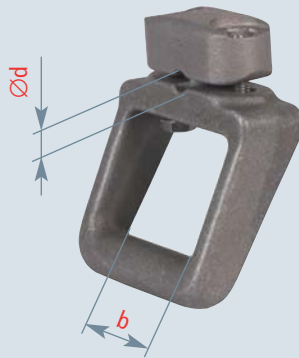
Fixed Phase Points for Al and Al/St Overhead Line  
Conductors

Type PFP ...	11 33 AL 60 82	34 48 AL 60 98	49 70 AL 60 126
Part No.	731 011	731 013	731 015
Clamp width b	82 mm	98 mm	126 mm
For conductors Ø d	11.0 ... 33 mm	33.1 ... 48 mm	48.1 ... 70 mm
Max. short-circuit current $I_k$ 0.5 s	33.5 kA	33.5 kA	33.5 kA
Max. short-circuit current $I_k$ 1 s	23.7 kA	23.7 kA	23.7 kA

## Fixed Phase Points for round Copper Conductors

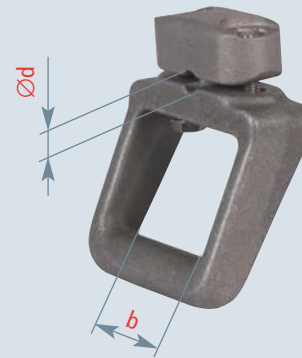

Type PFP ...	11 33 CU 60 82	PFP 34 48 CU 60 98
Part No.	731 027	731 037
Clamp width b	82 mm	98 mm
For conductors Ø d	11.0 ... 33 mm	33.1 ... 48 mm
Max. short-circuit current $I_k$ 0.5 s	33.5 kA	33.5 kA
Max. short-circuit current $I_k$ 1 s	23.7 kA	23.7 kA

Note: Conductor diameter d to be specified at order!

## Short-Circuiting Bar

## Earthing and Short-Circuiting Devices

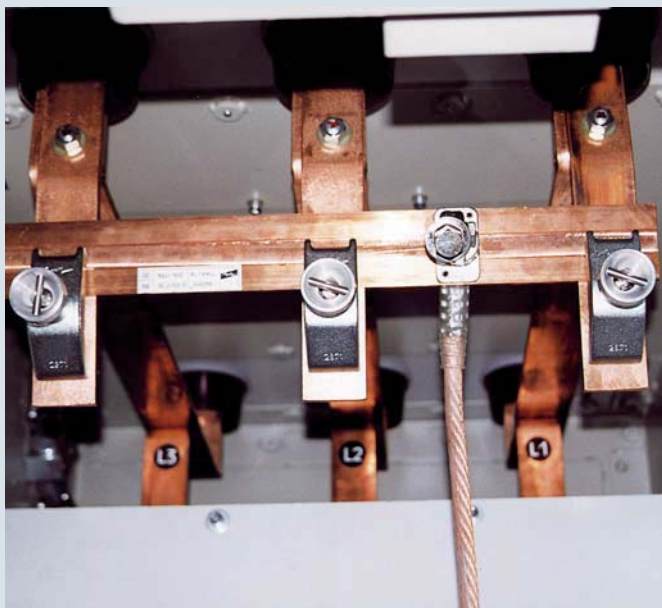

Short-circuiting bar with earthing cable on a switchgear installation

**General Information:**

Standard	EN/IEC 61230 (DIN VDE 0683 Part 100)
Temperature range	- 25 °C ... + 55 °C
Material (earthing cable)	Highly flexible copper
Cable cross-section	50 mm <sup>2</sup>

The short-circuiting bar with longitudinal slot can be used for installations without direct neutral point earthing.

For connecting the earthing cable to the earthing system it is fitted with a rigid ball head cap with a wing bolt for fixed ball points (Ø20 mm) (Part No. 772 312 (type KKH 20 FS)). Other equipment or cable lengths can be selected online via the earthing and short-circuiting configurator. Short-circuiting bars are available with two different coupling mechanisms for earthing sticks:



SK: Hexagon shaft



SQ: T pin shaft (bayonet locking mechanism)

- With longitudinal slot for reliable contact
- For copper or aluminium busbars up to a thickness of 25 mm
- For use with earthing sticks for hexagon or T pin shafts
- Other bar and earthing cable lengths can be selected online via the earthing and short-circuiting configurator

**EaS Configurator:**  
[www.dehn.de/en/euk](http://www.dehn.de/en/euk)

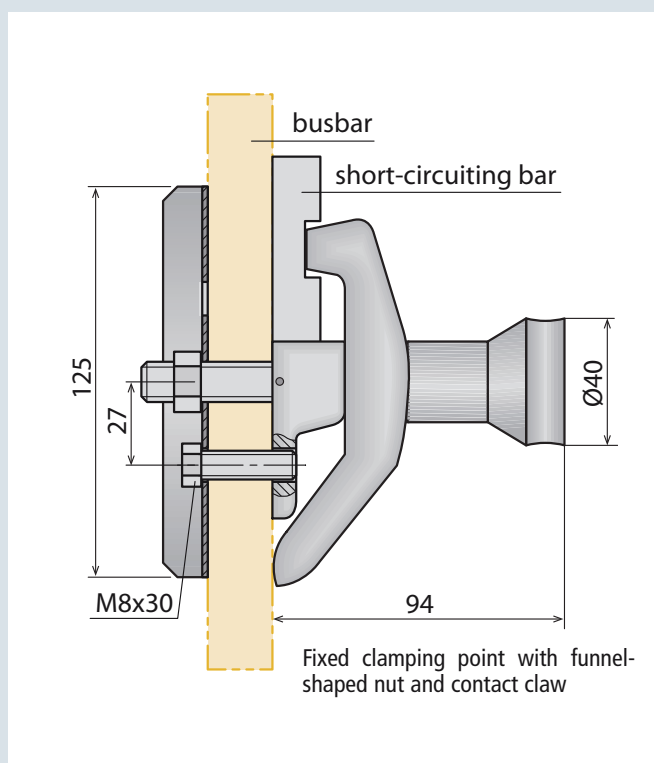
**Accessory for Short-Circuiting Bar****Fixed Clamping Point for Busbars**

Clamping point with fixing elements for a busbar thickness up to 25 mm and contact claw for short-circuiting bars with longitudinal slot

Type	KLFP M12 KSS
Part No.	795 040
Type	Screw-on shaft with aluminium funnel-shaped nut



Safety Equipment

Short-Circuiting Bar

Earthing and Short-Circuiting Devices

Short-Circuiting Bar made of Copper (E-Cu F20)

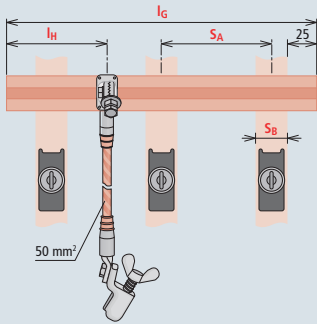

Type	KS60 8SK C	KS60 12SK C	KS60 8SQ C	KS60 12SQ C
Part No.	795 138	795 139	795 141	795 145
Variant No.	V96QGHR	VRECHFQ	VWRQLGM	VGCXPNC
Coupling mechanism	SK	SK	SQ	SQ
Position of the coupling mechanism ( $L_H$ )	200 mm	200 mm	200 mm	200 mm
Profile	60 x 8 mm	60 x 12 mm	60 x 8 mm	60 x 12 mm
Total length ( $l_G$ )	550 mm	550 mm	550 mm	550 mm
Bar spacing ( $S_A$ )	150 mm	150 mm	150 mm	150 mm
Max. short-circuit current $I_k$ 0.5 s	100 kA	130 kA	100 kA	130 kA
Max. short-circuit current $I_k$ 1 s	70 kA	90 kA	70 kA	90 kA

Short-Circuiting Bar made of Aluminium (AlMgSi 0.5)

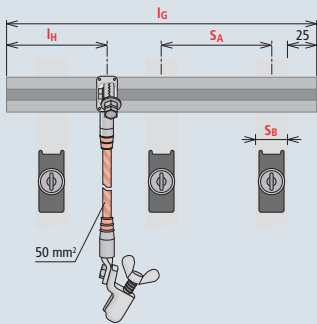

Type	KS60 8SK A	KS60 12SK A	KS60 8SQ A	KS60 12SQ A
Part No.	795 142	795 143	795 148	795 149
Variant No.	VF6L7FP	VLPGVCB	VW4QY2	VZS98VH
Coupling mechanism	SK	SK	SQ	SQ
Position of the coupling mechanism ( $L_H$ )	200 mm	200 mm	200 mm	200 mm
Profile	60 x 8 mm	60 x 12 mm	60 x 8 mm	60 x 12 mm
Total length ( $l_G$ )	550 mm	550 mm	550 mm	550 mm
Bar spacing ( $S_A$ )	150 mm	150 mm	150 mm	150 mm
Max. short-circuit current $I_k$ 0.5 s	60 kA	100 kA	60 kA	100 kA
Max. short-circuit current $I_k$ 1 s	45 kA	70 kA	45 kA	70 kA

Two coupling mechanisms are required for a total length > 1000 mm.

Note: When ordering, please specify the variant No. generated online via the earthing and short-circuiting configurator or fill in the template on page 86 and send it to us.

Accessory for Short-Circuiting Bar

SQ Screw-Type Adapter

Screw-type adapter for plugging into earthing sticks for tightening/loosening the funnel-shaped nut of the fixed clamping point

T pin shaft (bayonet coupling mechanism)

Type	SA KLFP SQ
Part No.	795 213
Total length ( $l_G$ )	100 mm



Accessory for Short-Circuiting Bar

SK Screw-Type Adapter

Screw-type adapter for plugging into earthing sticks for tightening/loosening the funnel-shaped nut of the fixed clamping point

Hexagon shaft (width across flats 19)

Type	SA KLFP SK
Part No.	795 214
Total length ( $l_G$ )	60 mm
Width A/F	19 mm



## Template

Safety Equipment

DEHN Form No. 2150/E/0412

Earthing and Short-Circuiting Devices

## Template for Short-circuiting Bars

acc. to IEC/EN 61230 (DIN VDE 0683-100)

EaS Configurator:  
www.dehn.de/en/euk

Customer:			
Customer No.:			
Company:			
Address:			
Address, country:			
Contact:			
Phone / fax:		E-Mail:	
<input type="checkbox"/> Enquiry	<input type="checkbox"/> Order	Quantity:	pc(s). Signature:

## 1 Material and short-circuit current:

Material	Short-circuit current 0.5 s	Short-circuit current 1 s	Bar profile
<input type="checkbox"/> Copper (E-Cu F20)	100 kA	70 kA	60 x 8 mm
<input type="checkbox"/> Copper (E-Cu F20)	130 kA	90 kA	60 x 12 mm
<input type="checkbox"/> Aluminium (AlMgSi 0.5)	60 kA	45 kA	60 x 8 mm
<input type="checkbox"/> Aluminium (AlMgSi 0.5)	100 kA	70 kA	60 x 12 mm

## 2 Coupling mechanism:

<input type="checkbox"/> T pin shaft (bayonet)	<input type="checkbox"/> Hexagon shaft
--	--

## 3 Dimensions:

Bar spacing $S_A$ (in the installation):	Bar width $S_B$ (in the installation):	OR	Total length $l_G$ :	Bar spacing $S_A$ (in the installation):
mm	mm		mm	mm
From 30 up to 500 mm at intervals of 5 mm	From 40 up to 150 mm at intervals of 5 mm		From 200 up to 2000 mm at intervals of 50 mm	From 30 up to 500 mm at intervals of 5 mm

4 Cable length D (50 mm<sup>2</sup>):

Standard: D = 2500 mm	mm
	From 250 up to 25000 mm at intervals of 100 mm

## 5 Equipment of the earth cable end:

Standard:	see easy choice:
Type or Part No. KKH 20 FD	<input type="checkbox"/> Type or Part No.
Type or Part No. 772 312	

## 6 Accessory (optional):

<input type="checkbox"/> Fixed clamping points for busbars 3x Part No. 795 040	
<input type="checkbox"/> SQ screw-type adapter Part No. 795 213	<input type="checkbox"/> SK screw-type adapter Part No. 795 214
<input type="checkbox"/> see easy choice	Type or Part No.
<input type="checkbox"/> Earthing Stick	

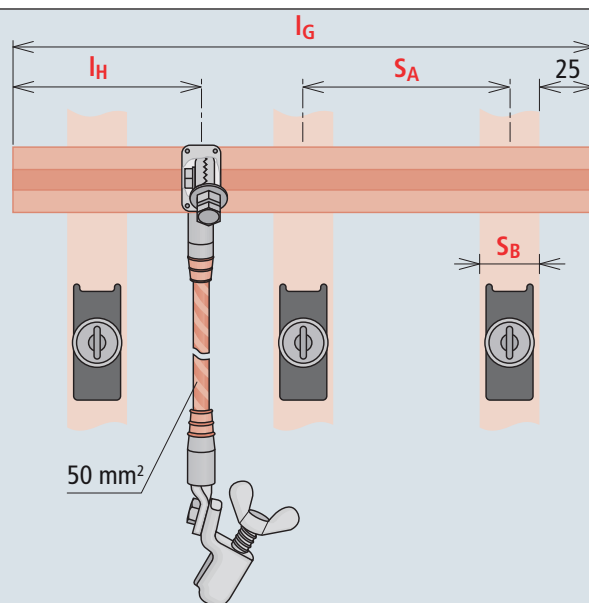
DEHN + SÖHNE  
GmbH + Co.KG.Hans-Dehn-Str. 1  
Postfach 1640  
92306 Neumarkt  
GermanyTel. +49 9181 906-0  
Fax +49 9181 906-1444  
info@dehn.de  
www.dehn.deTechnical Support:  
Tel. +49 9181 906-1510

## Earthing and Short-Circuiting Devices

- To be equipped with connecting components
- Transparent sheath
- Waterproof plastic-sheathed cable entries and node unit, additional anti-kink protection
- Standard anti-rotation crimped cable lugs (type PK1)
- Other cable lengths and crimped cable lugs can be selected online via the earthing and short-circuiting configurator
- Earthing and short-circuiting devices can be configured online via the earthing and short-circuiting configurator

**EaS Configurator:**  
[www.dehn.de/en/euk](http://www.dehn.de/en/euk)



Equipped three-pole earthing and short-circuiting device in a switchgear installation

**General Information:**

Standard	EN/IEC 61138 (DIN VDE 0283 Part 3) and EN/IEC 61230 (DIN VDE 0683 Part 100)
Temperature range	- 25 °C ... + 55 °C
Material (cable)	E-Cu, extra finely stranded and highly flexible
Material (sheath)	Thermoplastic polymer (flexible PVC compound YM2)
Hole (cable lug)	Ø12.5 mm



Crimped cable lugs, type **PK1**:  
 Standard anti-rotation cable lug with cut-out.

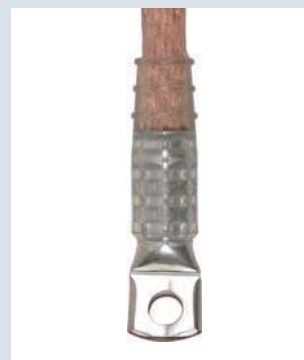

Crimped cable lugs, type **PK2**:  
 Cable lug without cut-out for connecting parts from other manufacturers are available on request.



Crimped cable lugs, type **PK3**:  
 Hook-type cable lugs up to cable cross-sections of 35 mm<sup>2</sup> are available on request.



## Earthing and Short-Circuiting Cables, unequipped

Sicherheitsgeräte

## Single-pole Earthing and Short-Circuiting Cables

Earthing and Short-Circuiting Devices



Type	EKV1+0 16	EKV1+0 25	EKV1+0 35	EKV1+0 50	EKV1+0 70	EKV1+0 95	EKV1+0 120	EKV1+0 150
Part No.	716 100	725 100	735 100	750 100	770 100	795 100	712 100	715 100
Variant No.	V4YPRGE	VSY71K4	V9JF26K	VRJG23Y	VPZBBSL	VZC3FST	V797FE6	VB53TC9
Crimped cable lug	PK1	PK1	PK1	PK1	PK1	PK1	PK1	PK1
Cable cross-section	16 mm <sup>2</sup>	25 mm <sup>2</sup>	35 mm <sup>2</sup>	50 mm <sup>2</sup>	70 mm <sup>2</sup>	95 mm <sup>2</sup>	120 mm <sup>2</sup>	150 mm <sup>2</sup>
Max. short-circuit current $I_k$ 0.5 s	4.5 kA	7.0 kA	10.0 kA	14.0 kA	19.5 kA	26.5 kA	33.5 kA	42.0 kA
Max. short-circuit current $I_k$ 1 s	3.2 kA	4.9 kA	6.9 kA	9.9 kA	13.8 kA	18.7 kA	23.7 kA	29.6 kA

## Two-pole Earthing and Short-Circuiting Cables



Type	EKV2+0 16 G	EKV2+0 25 G	EKV2+0 35 G	EKV2+0 50 G	EKV2+0 70 G	EKV2+0 95 G	EKV2+0 120 G	EKV2+0 150 G
Part No.	716 200	725 200	735 200	750 202	770 200	795 200	712 200	715 200
Variant No.	V7265NS	VZL6TGH	VPHPZV2	VJ13VWW	VTJKEZU	VAM7M6H	VFV1Z7K	VLL6JWS
Crimped cable lug	PK1	PK1	PK1	PK1	PK1	PK1	PK1	PK1
Cable cross-section	16 mm <sup>2</sup>	25 mm <sup>2</sup>	35 mm <sup>2</sup>	50 mm <sup>2</sup>	70 mm <sup>2</sup>	95 mm <sup>2</sup>	120 mm <sup>2</sup>	150 mm <sup>2</sup>
Max. short-circuit current $I_k$ 0.5 s	4.5 kA	7.0 kA	10.0 kA	14.0 kA	19.5 kA	26.5 kA	33.5 kA	42.0 kA
Max. short-circuit current $I_k$ 1 s	3.2 kA	4.9 kA	6.9 kA	9.9 kA	13.8 kA	18.7 kA	23.7 kA	29.6 kA

## Three-pole Earthing and Short-Circuiting Cables, same Cable Cross-Section

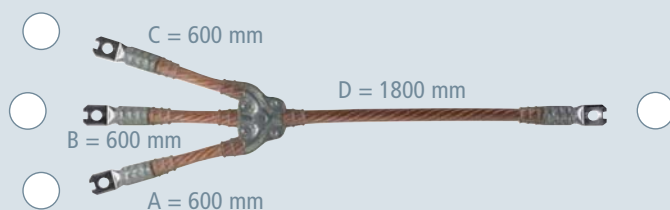

Type	EKV3+0 16 G	EKV3+0 25 G	EKV3+0 35 G	EKV3+0 50 G	EKV3+0 70 G	EKV3+0 95 G	EKV3+0 120 G	EKV3+0 150 G
Part No.	716 300	725 300	735 300	750 300	770 300	795 300	712 300	715 300
Variant No.	VE5MT89	VNC1S9W	V18JQHQ	VJ7VGZD	VH95BZZ	VM2J7S3	V8D4AQ2	VG3V6T2
Crimped cable lug	PK1	PK1	PK1	PK1	PK1	PK1	PK1	PK1
Cable cross-section	16 mm <sup>2</sup>	25 mm <sup>2</sup>	35 mm <sup>2</sup>	50 mm <sup>2</sup>	70 mm <sup>2</sup>	95 mm <sup>2</sup>	120 mm <sup>2</sup>	150 mm <sup>2</sup>
Max. short-circuit current $I_k$ 0.5 s	4.5 kA	7.0 kA	10.0 kA	14.0 kA	19.5 kA	26.5 kA	33.5 kA	42.0 kA
Max. short-circuit current $I_k$ 1 s	3.2 kA	4.9 kA	6.9 kA	9.9 kA	13.8 kA	18.7 kA	23.7 kA	29.6 kA

## Three-pole Earthing and Short-Circuiting Cables, reduced Cable Cross-Section

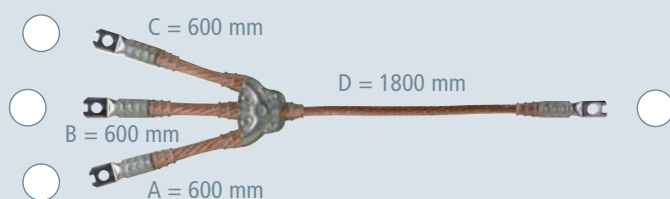

Type	EKV3+0 50 R	EKV3+0 70 R	EKV3+0 95 R	EKV3+0 120 R	EKV3+0 150 R
Part No.	750 301	770 301	795 301	712 301	715 301
Variant No.	VN35H5D	VTC2SXV	VLB2F3G	V8115WA	V11E77B
Crimped cable lug	PK1	PK1	PK1	PK1	PK1
Cable cross-section	50/25 mm <sup>2</sup>	70/35 mm <sup>2</sup>	95/35 mm <sup>2</sup>	120/50 mm <sup>2</sup>	150/50 mm <sup>2</sup>
Max. short-circuit current $I_k$ 0.5 s	14.0 kA	19.5 kA	26.5 kA	33.5 kA	42.0 kA
Max. short-circuit current $I_k$ 1 s	9.9 kA	13.8 kA	18.7 kA	23.7 kA	29.6 kA

Safety Equipment

Earthing and Short-Circuiting Cables, unequipped

Earthing and Short-Circuiting Devices

Four-pole Earthing and Short-Circuiting Cables

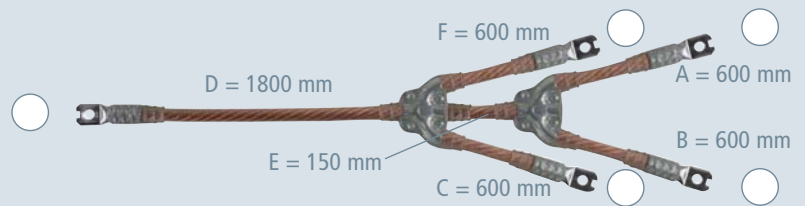

Type	EKV4u0 16 G	EKV4u0 25 G	EKV4u0 35 G	EKV4u0 50 G	EKV4u0 70 G	EKV4u0 95 G	EKV4u0 120 G	EKV4u0 150 G
Part No.	716 401	725 401	735 401	750 401	770 401	795 401	712 401	715 401
Variant No.	VGUVRRG	VGM214B	V93UVAP	V3NC SHX	V7GN8WU	VABRSSE	V27E2GP	V291ZZT
Crimped cable lug	PK1	PK1	PK1	PK1	PK1	PK1	PK1	PK1
Cable cross-section	16 mm <sup>2</sup>	25 mm <sup>2</sup>	35 mm <sup>2</sup>	50 mm <sup>2</sup>	70 mm <sup>2</sup>	95 mm <sup>2</sup>	120 mm <sup>2</sup>	150 mm <sup>2</sup>
Max. short-circuit current I <sub>k</sub> 0.5 s	4.5 kA	7.0 kA	10.0 kA	14.0 kA	19.5 kA	26.5 kA	33.5 kA	42.0 kA
Max. short-circuit current I <sub>k</sub> 1 s	3.2 kA	4.9 kA	6.9 kA	9.9 kA	13.8 kA	18.7 kA	23.7 kA	29.6 kA

Five-pole Earthing and Short-Circuiting Cables

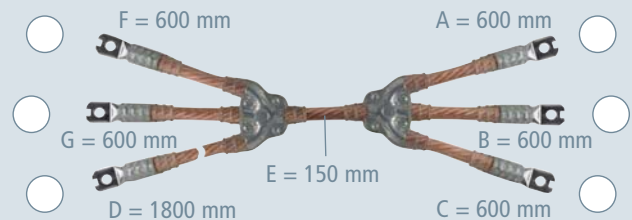

Type	EKV5+0 16 G	EKV5+0 25 G	EKV5+0 35 G	EKV5+0 50 G	EKV5+0 70 G	EKV5+0 95 G	EKV5+0 120 G	EKV5+0 150 G
Part No.	716 500	725 500	735 500	750 510	770 500	795 500	712 500	715 500
Variant No.	VQ7PF5A	VZKQZB5	V76D5TH	V6VE249	VDXTBGF	VGCMAA5	VVL7AKP	VHV1NKR
Crimped cable lug	PK1	PK1	PK1	PK1	PK1	PK1	PK1	PK1
Cable cross-section	16 mm <sup>2</sup>	25 mm <sup>2</sup>	35 mm <sup>2</sup>	50 mm <sup>2</sup>	70 mm <sup>2</sup>	95 mm <sup>2</sup>	120 mm <sup>2</sup>	150 mm <sup>2</sup>
Max. short-circuit current I <sub>k</sub> 0.5 s	4.5 kA	7.0 kA	10.0 kA	14.0 kA	19.5 kA	26.5 kA	33.5 kA	42.0 kA
Max. short-circuit current I <sub>k</sub> 1 s	3.2 kA	4.9 kA	6.9 kA	9.9 kA	13.8 kA	18.7 kA	23.7 kA	29.6 kA

Note: When ordering please specify the Variant No.

Earthing Cable in accordance with IEC 61138

The cable is delivered without crimped cable lugs and can be ordered by the metre.



Type	ES YM2 16	ES YM2 25	ES YM2 35	ES YM2 50	ES YM2 70	ES YM2 95	ES YM2 120	ES YM2 150
Part No.	716 001	725 001	735 001	750 001	770 001	795 001	712 001	715 001
Cable cross-section	16 mm <sup>2</sup>	25 mm <sup>2</sup>	35 mm <sup>2</sup>	50 mm <sup>2</sup>	70 mm <sup>2</sup>	95 mm <sup>2</sup>	120 mm <sup>2</sup>	150 mm <sup>2</sup>
Minimum order quantity <sup>*)</sup>	1 m	1 m	1 m	1 m	1 m	1 m	1 m	1 m

<sup>\*)</sup> Please specify the length of the earthing cable when ordering (in whole metres)

## Phase Connecting Elements for Switchgear Installations

Safety Equipment

### Ball head caps and universal clamps

Phase Connecting Elements



Connecting the phase cable end with universal clamp to a fixed ball point

**EaS Configurator:**  
[www.dehn.de/en/euk](http://www.dehn.de/en/euk)

- To be fitted to the phase cable end of single-pole to five-pole earthing and short-circuiting devices
- Anti-rotation cable lug of type PK1
- Other cable lengths can be configured online via the earthing and short-circuiting configurator

#### General Information:

Standard	EN/IEC 61230 (DIN VDE 0683 Part 100), threaded T pin shaft DIN 48087
Temperature range	– 25 °C ... + 55 °C
Material (clamp body)	Copper alloy/gal Sn
Material (shaft)	Copper alloy/gal Sn
Material (pressure plate)	Copper alloy/gal Sn / St/Zn

Two types of ball head caps are available:

- Rigid ball head cap
- Adjustable ball head cap (4x 90°)

The adjustable ball head cap allows the user to connect the earthing and short-circuiting device to fixed points that are installed in unfavourable positions. Thus, in the vast majority of cases, angled fixed ball points no longer have to be used.



Rigid ball head cap

Adjustable ball head cap (4 x 90°)



SK: Hexagon shaft

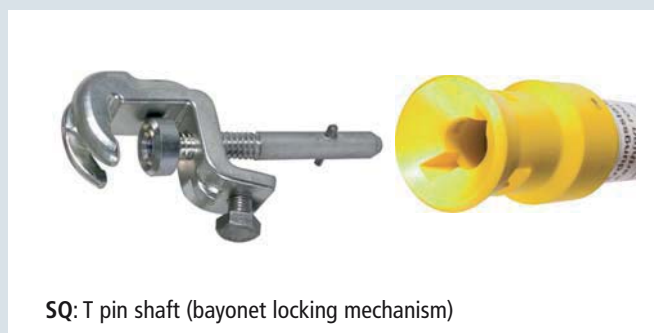

SQ: T pin shaft (bayonet locking mechanism)

#### \*) Clamping range and maximum cable cross-section of universal clamps used for:

Fixed ball point Ø	Phase T pin collar width	Rd / Fl clamping range	Cable cross-section
20 / 25 / 30 mm	15 / 18 mm	20 / 30 mm	70 mm <sup>2</sup>
20 / 25 / 30 mm	15 / 18 mm	–	95 mm <sup>2</sup>
– / 25 / 30 mm	–	–	120 mm <sup>2</sup>

*The clamps must have the same maximum short-circuit current as the earthing and short-circuiting cables!*

## Safety Equipment

## Phase Connecting Elements for Switchgear Installations

## Phase Connecting Elements

## Rigid Ball Head Cap, hexagon Shaft



Type	KKH 20 SK	KKH 25 SK
Part No.	772 310	772 320
For fixed ball point Ø	20 mm	25 mm
For cable cross-sections	16 ... 120 mm <sup>2</sup>	16 ... 150 mm <sup>2</sup>
Max. short-circuit current I <sub>k</sub> 0.5 s	33.5 kA	42.0 kA
Max. short-circuit current I <sub>k</sub> 1 s	23.7 kA	29.6 kA

## Rigid Ball Head Cap, T Pin Shaft



Type	KKH 20 SQ	KKH 25 SQ
Part No.	772 311	772 321
For fixed ball point Ø	20 mm	25 mm
For cable cross-sections	16 ... 120 mm <sup>2</sup>	16 ... 150 mm <sup>2</sup>
Max. short-circuit current I <sub>k</sub> 0.5 s	33.5 kA	42.0 kA
Max. short-circuit current I <sub>k</sub> 1 s	23.7 kA	29.6 kA

## Adjustable Ball Head Cap (4 x 90°), hexagon Shaft



Type	KKH 20 D SK	KKH 25 D SK
Part No.	772 330	772 340
For fixed ball point Ø	20 mm	25 mm
For cable cross-sections	16 ... 120 mm <sup>2</sup>	16 ... 150 mm <sup>2</sup>
Max. short-circuit current I <sub>k</sub> 0.5 s	33.5 kA	42.0 kA
Max. short-circuit current I <sub>k</sub> 1 s	23.7 kA	29.6 kA

## Adjustable Ball Head Cap (4 x 90°), T Pin Shaft



Type	KKH 20 D SQ	KKH 25 D SQ
Part No.	772 331	772 341
For fixed ball point Ø	20 mm	25 mm
For cable cross-sections	16 ... 120 mm <sup>2</sup>	16 ... 150 mm <sup>2</sup>
Max. short-circuit current I <sub>k</sub> 0.5 s	33.5 kA	42.0 kA
Max. short-circuit current I <sub>k</sub> 1 s	23.7 kA	29.6 kA

## Universal Clamp, hexagon Shaft



Type	UK 25 SK	UK 30 SK
Part No.	773 034	773 130
For fixed ball point Ø	20 / 25 mm	25 / 30 mm
For T pins with a collar width of	15 mm	18 mm
Rd / Fl clamping range	20 mm	30 mm
For cable cross-sections	16 ... 120 <sup>*)</sup> mm <sup>2</sup>	16 ... 120 <sup>*)</sup> mm <sup>2</sup>
Max. short-circuit current I <sub>k</sub> 0.5 s	33.5 kA	33.5 kA
Max. short-circuit current I <sub>k</sub> 1 s	23.7 kA	23.7 kA

<sup>\*)</sup> see table for clamping ranges and maximum cable cross-sections for universal clamps

## Universal Clamp, T Pin Shaft



Type	UK 25 SQ	UK 30 SQ
Part No.	773 234	773 330
For fixed ball point Ø	20 / 25 mm	25 / 30 mm
For T pins with a collar width of	15 mm	18 mm
Rd / Fl clamping range	20 mm	30 mm
For cable cross-sections	16 ... 120 <sup>*)</sup> mm <sup>2</sup>	16 ... 120 <sup>*)</sup> mm <sup>2</sup>
Max. short-circuit current I <sub>k</sub> 0.5 s	33.5 kA	33.5 kA
Max. short-circuit current I <sub>k</sub> 1 s	23.7 kA	23.7 kA

<sup>\*)</sup> see table for clamping range and maximum cable cross-section for universal clamps

## Phase Connecting Elements for Overhead Lines up to Ø85 mm

Safety Equipment

### Phase screw clamps for overhead line conductors Ø4 to 85 mm

Phase Connecting Elements



Phase screw clamps used on an overhead line

- To be fitted to the phase cable end of single-pole and three-pole earthing and short-circuiting devices used for overhead lines
- Coupling aid for safe installation of the phase screw clamps on overhead line conductors
- Easy coupling due to spring-loaded clamp
- Anti-rotation cable lugs of type PK1 or PK2 and long threaded T pin shaft
- Earthing and short-circuiting devices can be configured online via the earthing and short-circuiting configurator

**EaS Configurator:**  
[www.dehn.de/en/euk](http://www.dehn.de/en/euk)

#### General Information:

Standard	EN/IEC 61230 (DIN VDE 0683 Part 100), threaded T pin shaft DIN 48087
Temperature range	- 25 °C ... + 55 °C
Material (pressure plate)	Aluminium alloy
Material (clamp body)	Aluminium alloy
Material (shaft)	Copper alloy/gal Sn or StSt
Material (coupling aid)	St/gal Zn



Phase screw clamp fitted with fixed coupling aid allows safe coupling



Spring-loaded phase screw clamp



Clamp with long shaft and earthing stick with aluminium cone coupling



Crimped cable lugs, type PK1: Standard anti-rotation cable lug with cut-out.



Crimped cable lugs, type PK2: Cable lug without cut-out for connecting parts from other manufacturers are available on request.

### Accessory for Phase Connecting Elements

#### Two-pole Phase Connecting Plate

Two screw connections for phase screw clamps with anti-rotation cable lug of type PK1



Type	PAP 2 M12 SSM B13
Part No.	728 312
Anti-rotation cable lug	PK1
Max. short-circuit current $I_k$ 0.5 s	33.5 kA
Max. short-circuit current $I_k$ 1 s	23.7 kA



## Safety Equipment

## Phase Connecting Elements for Overhead Lines up to Ø85 mm

## Phase Connecting Elements

## Standard Phase Screw Clamp

Short-circuit-proof, even in case of corroded overhead conductors due to weathering



Type	PSK 4 30 SQL	PSK 10 65 SQL
Part No.	784 201	784 301
Clamping range Ø	4 ... 30 mm	10 ... 65 mm
Anti-rotation cable lug	PK1	PK1
For cable cross-sections	16 ... 70 mm <sup>2</sup>	16 ... 120 mm <sup>2</sup>
Max. short-circuit current I <sub>k</sub> 0.5 s	19.5 kA	33.5 kA
Max. short-circuit current I <sub>k</sub> 1 s	13.8 kA	23.7 kA

## Phase Screw Clamp with Coupling Aid

Short-circuit-proof, even in case of corroded overhead conductors due to weathering



Type	PSK 4 30 SQL EH	PSK 10 65 SQL EH
Part No.	784 401	784 501
Clamping range Ø	4 ... 30 mm	10 ... 65 mm
Anti-rotation cable lug	PK1	PK1
For cable cross-sections	16 ... 70 mm <sup>2</sup>	16 ... 120 mm <sup>2</sup>
Max. short-circuit current I <sub>k</sub> 0.5 s	19.5 kA	33.5 kA
Max. short-circuit current I <sub>k</sub> 1 s	13.8 kA	23.7 kA

## Spring-loaded Phase Screw Clamp

Easy coupling due to spring-loaded clamp



Type	PSK FV 4 30 SQL
Part No.	784 480
Clamping range Ø	4 ... 30 mm
Anti-rotation cable lug	PK1
For cable cross-sections	16 ... 70 mm <sup>2</sup>
Max. short-circuit current I <sub>k</sub> 0.5 s	19.5 kA
Max. short-circuit current I <sub>k</sub> 1 s	13.8 kA

## Phase Screw Clamp with wide Clamping Range

Ideally suited for use with Al and Al/St overhead conductors, pipes and fixed phase points



Type	PSK 10 85 SQL
Part No.	784 085
Clamping range Ø	10 ... 85 mm
Anti-rotation cable lug	PK2
For cable cross-sections	16 ... 150 mm <sup>2</sup>
Max. short-circuit current I <sub>k</sub> 0.5 s	29.6 kA
Max. short-circuit current I <sub>k</sub> 1 s	29.6 kA

## Phase Screw Clamp

Ideally suited for angled positions



Type	PSK 10 32 SQL
Part No.	784 032
Clamping range Ø	10 ... 32 mm
Anti-rotation cable lug	PK2
For cable cross-sections	16 ... 95 mm <sup>2</sup>
Max. short-circuit current I <sub>k</sub> 0.5 s	18.7 kA
Max. short-circuit current I <sub>k</sub> 1 s	18.7 kA

## Phase Screw Clamp with Safety Bow

Ideally suited for use in inclined positions



Type	PSK 10 32 SQL SB
Part No.	784 038
Clamping range Ø	10 ... 32 mm
Anti-rotation cable lug	PK2
For cable cross-sections	16 ... 95 mm <sup>2</sup>
Max. short-circuit current I <sub>k</sub> 0.5 s	18.7 kA
Max. short-circuit current I <sub>k</sub> 1 s	18.7 kA

*The clamps must have the same maximum short-circuit current as the earthing and short-circuiting cables!*

## Phase Connecting Elements for Overhead Lines up to Ø25 mm

Safety Equipment

### Phase clamp for overhead line conductors Ø4 to 25 mm

Phase Connecting Elements



Removal of a phase clamp using a single-pole coupling aid

- Spring-loaded clamp for overhead lines without shaft
- Single-pole or three-pole coupling aid for easy coupling and removal of the clamp
- Light-weight construction
- With two screw connections for type PK1 cable lugs
- To be fitted to the phase cable end of single-pole to three-pole earthing and short-circuiting cables

#### General Information:

Standard	EN/IEC 61230 (DIN VDE 0683 Part 100)
Temperature range	- 25 °C ... + 55 °C
Material (pressure plate)	Aluminium alloy
Material (clamp body)	Aluminium alloy
Material ( tension spring)	St
Material (bolt)	StSt A2-70

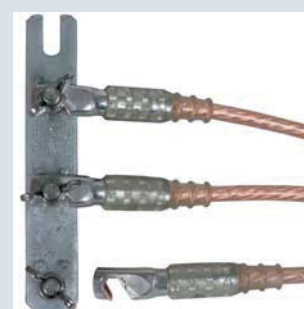
Crimped cable lugs of type PK1:  
Cable lug with cut-out mounted to the phase clampCrimped cable lugs of type PK3:  
Anti-rotation hook-type cable lug mounted to a three-pole earthing busbar

**Single-pole coupling aid:**  
with telescopic insulating stick.  
Recommended earthing cable cross-section between 16 mm<sup>2</sup> and max. 25 mm<sup>2</sup>.



**Three-pole coupling aid:**  
with earthing stick (T pin shafts)  
and lock nut for positioning the coupling aid in the cone coupling.

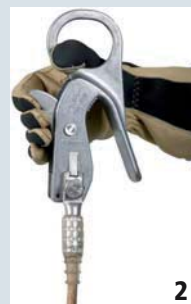

Figure 1 and 2:  
Biassing the clamp via the pressure plate

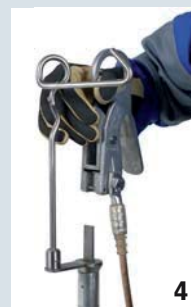

Figure 3 and 4:  
Attaching the clamp to the coupling aid

## Safety Equipment

## Phase Connecting Elements for Overhead Lines up to Ø25 mm

## Phase Connecting Elements

The pre-loaded clamp is connected by simply removing the coupling aid

Type	PK FV 4 25
Part No.	784 490
Clamping range Ø	4 ... 25 mm
Anti-rotation cable lug	PK1 / PK1
For cable cross-sections	16 ... 70 mm <sup>2</sup>
Max. short-circuit current I <sub>k</sub> 0.5 s	13.8 kA
Max. short-circuit current I <sub>k</sub> 1 s	13.8 kA



## Accessory for Phase Connecting Elements

## Single-pole Coupling Aid with Gear Coupling

For ISMTC N 36 ZK 10600 telescopic sticks for use from the ground

Type	EH1 PK FV ZK
Part No.	784 461
Total length	520 mm



## Accessory for Phase Connecting Elements

## Three-pole Coupling Aid with T Pin Shaft

For earthing sticks with bayonet locking mechanism for use from towers or aerial working platforms

Type	EH3 PK FV SQL
Part No.	784 463
Total length	500 mm



## Earthing Kit

Type	ES 3P FL ER
Part No.	799 009
Length (drill)	1000 mm



## Phase Connecting Elements for Overhead Lines

Safety Equipment

### Clamps with long shaft

Phase Connecting Elements



Rigid ball head cap with long shaft and earthing stick

#### General Information:

Standard	EN/IEC 61230 (DIN VDE 0683 Part 100), threaded T pin shaft DIN 48087
Temperature range	- 25 °C ... + 55 °C
Material (clamp body)	Copper alloy/gal Sn
Material (shaft)	Copper alloy/gal Sn
Material (pressure plate)	Copper alloy/gal Sn / St/Zn

### Rigid Ball Head Cap, long T Pin Shaft



Type	KKH 20 SQL	KKH 25 SQL
Part No.	772 314	772 324
For fixed ball point Ø	20 mm	25 mm
For cable cross-sections	16 ... 120 mm <sup>2</sup>	16 ... 150 mm <sup>2</sup>
Max. short-circuit current I <sub>k</sub> 0.5 s	3.5 kA	42.0 kA
Max. short-circuit current I <sub>k</sub> 1 s	23.7 kA	29.6 kA

- To be fitted to the phase cable end of single-pole and three-pole earthing and short-circuiting devices used for overhead lines
- Long threaded T pin shaft for earthing sticks with robust aluminium cone coupling
- Anti-rotation cable lug of type PK1
- Other cable lengths can be configured online via the earthing and short-circuiting configurator

EaS Configurator:  
[www.dehn.de/en/euk](http://www.dehn.de/en/euk)



Clamp with long shaft and earthing stick with aluminium cone coupling

#### \*) Clamping range and maximum cable cross-section of universal clamps used for:

Fixed ball point Ø	Phase T pin collar width	Rd / Fl clamping range	Cable cross-section
20 / 25 / 30 mm	15 / 18 mm	20 / 30 mm	70 mm <sup>2</sup>
20 / 25 / 30 mm	15 / 18 mm	–	95 mm <sup>2</sup>
– / 25 / 30 mm	–	–	120 mm <sup>2</sup>

### Universal Clamp, long T Pin Shaft



Type	UK 25 SQL	UK 30 SQL
Part No.	773 236	773 331
Clamping range	20 mm	30 mm
For fixed ball point Ø	20 / 25 mm	25 / 30 mm
For T pins with a collar width of	15 mm	18 mm
Rd / Fl clamping range	20 mm	30 mm
For cable cross-sections	16 ... 120 <sup>1)</sup> mm <sup>2</sup>	16 ... 120 <sup>1)</sup> mm <sup>2</sup>
Max. short-circuit current I <sub>k</sub> 0.5 s	33.5 kA	33.5 kA
Max. short-circuit current I <sub>k</sub> 1 s	23.7 kA	23.7 kA

<sup>1)</sup> See table for the clamping range and max. cable cross-section of universal clamps

*The clamps must have the same maximum short-circuit current as the earthing and short-circuiting cables!*

## Safety Equipment

## Earthing Kit

## Earth Connecting Elements

- For overhead line systems
- For driving the tubular earth electrode with drill into the ground
- Kit includes tubular earth electrode, three-pole earthing busbar and artificial leather bag



Earthing busbar and earthing cables mounted on a tubular earth electrode



Crimped cable lugs, type PK3:  
Anti-rotation hook-type cable lug mounted on a three-pole earthing busbar.

**General Information:**

Material (tubular earth electrode)	St/tZn
Material (bolt)	StSt (V2A)
Material (handle)	Wood
Material (earthing bar)	St/tZn

**Kit includes:**

Pos. No.	Part No.
1	644 000
2	799 019
3	766 601

For more detailed information on these products, see Accessory chapter

**Accessory for Earthing Kit****Tubular earth electrode with drill**

Part No.	644 000
Total length ( $l_G$ )	1000 mm
Military No.	VG 96953 T10 A0001
Supply No.	5975-12-120-0006



Type	ES 3P FL ER
Part No.	799 009
Total length ( $l_G$ )	1000 mm
Bolt	M10 x 35 mm

**Three-pole Earthing Busbar**

With slot for mounting the earthing busbar on the tubular earth electrode, for hook-type cable lug of type PK3

Type	ESS 3P M10 FM
Part No.	799 019
Dimensions	180 x 30 x 5 mm
Bolt	3x M10 x 35 mm





## Earth Connecting Elements – Universal Earth Clamps

Safety Equipment

Clamping range 20 or 30 mm

Earth Connecting Elements



Universal earth clamp with handle connected to a fixed ball point

- To be fitted to the earth cable end for connection to fixed ball points, T pins, round and flat conductors
- For wide clamping ranges up to 30 mm
- Anti-rotation cable lug of type PK1
- Earthing and short-circuiting devices can be configured online by means of the earthing and short-circuiting configurator

EaS Configurator:  
[www.dehn.de/en/euk](http://www.dehn.de/en/euk)

### General Information:

Standard	EN/IEC 61230 (DIN VDE 0683 Part 100)
Temperature range	- 25 °C ... + 55 °C
Material (clamp body)	Copper alloy/gal Sn
Material (shaft)	Copper alloy/gal Sn
Material (pressure plate)	St/gal Zn

*) Clamping range and maximum cable cross-section of universal clamps used for:			
Fixed ball point Ø	Phase T pin collar width	Rd / Fl clamping range	Cable cross-section
20 / 25 / 30 mm	15 / 18 mm	20 / 30 mm	70 mm <sup>2</sup>
20 / 25 / 30 mm	15 / 18 mm	–	95 mm <sup>2</sup>
– / 25 / 30 mm	–	–	120 mm <sup>2</sup>

### Universal Clamps with plastic Handle



Type	UEK 25 HG	UEK 30 HG
Part No.	774 234	774 330
For fixed ball point Ø	20 / 25 mm	25 / 30 mm
For T pins with a collar width of	15 mm	18 mm
Rd / Fl clamping range	20 mm	30 mm
For cable cross-sections	16 ... 120 <sup>1)</sup> mm <sup>2</sup>	16 ... 120 <sup>1)</sup> mm <sup>2</sup>
Max. short-circuit current I <sub>k</sub> 0.5 s	33.5 kA	33.5 kA
Max. short-circuit current I <sub>k</sub> 1 s	23.7 kA	23.7 kA

\*) See table for clamping ranges and maximum cable cross-sections of universal clamps

### Universal Clamps with Wing Bolt



Type	UEK 25 FS	UEK 30 FS
Part No.	774 034	774 130
For fixed ball point Ø	20 / 25 mm	25 / 30 mm
For T pins with a collar width of	15 mm	18 mm
Rd / Fl clamping range	20 mm	30 mm
For cable cross-sections	16 ... 120 <sup>1)</sup> mm <sup>2</sup>	16 ... 120 <sup>1)</sup> mm <sup>2</sup>
Max. short-circuit current I <sub>k</sub> 0.5 s	33.5 kA	33.5 kA
Max. short-circuit current I <sub>k</sub> 1 s	23.7 kA	23.7 kA

\*) See table for clamping ranges and maximum cable cross-sections of universal clamps

### Universal Clamps with Tommy Bar

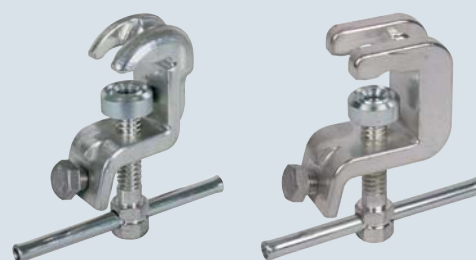

Type	UEK 25 SKN	UEK 30 SKN
Part No.	774 434	774 530
For fixed ball point Ø	20 / 25 mm	30 mm
For T pins with a collar width of	15 mm	18 mm
Rd / Fl clamping range	20 mm	30 mm
For cable cross-sections	16 ... 120 <sup>1)</sup> mm <sup>2</sup>	16 ... 120 <sup>1)</sup> mm <sup>2</sup>
Max. short-circuit current I <sub>k</sub> 0.5 s	33.5 kA	33.5 kA
Max. short-circuit current I <sub>k</sub> 1 s	23.7 kA	23.7 kA

\*) See table for clamping ranges and maximum cable cross-sections of universal clamps

The clamps must have the same maximum short-circuit current as the earthing and short-circuiting cables!

## Sicherheitsgeräte

## Earth Connecting Elements – Ball Head Caps

## Earth Connecting Elements

Ø20 or 25 mm, rigid

- To be fitted to the earth cable end for connection to fixed ball points (Ø20 or 25 mm)
- Ball head cap with wing bolt or handle
- Anti-rotation cable lug of type PK1
- Earthing and short-circuiting devices can be configured online by means of the earthing and short-circuiting configurator

EaS Configurator:  
[www.dehn.de/en/euk](http://www.dehn.de/en/euk)

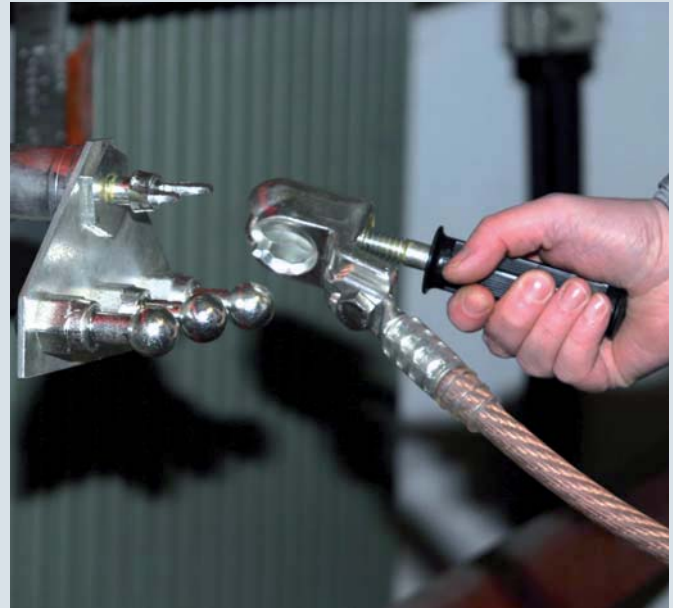

Ball head cap with handle to be connected to an earth connecting plate

**General Information:**

Standard	EN/IEC 61230 (DIN VDE 0683 Part 100)
Temperature range	– 25 °C ... + 55 °C
Material (clamp body)	Copper alloy/gal Sn
Material (shaft)	Copper alloy/gal Sn
Material (pressure plate)	Copper alloy/gal Sn

## Rigid Ball Head Caps with Wing Bolt



Type	KKH 20 FS	KKH 25 FS
Part No.	772 312	772 322
For fixed ball point Ø	20 mm	25 mm
For cable cross-sections	16 ... 120 mm <sup>2</sup>	16 ... 150 mm <sup>2</sup>
Max. short-circuit current I <sub>k</sub> 0.5 s	33.5 kA	42.0 kA
Max. short-circuit current I <sub>k</sub> 1 s	23.7 kA	29.6 kA

## Rigid Ball Head Caps with plastic Handle



Type	KKH 20 HG	KKH 25 HG
Part No.	772 313	772 323
For fixed ball point Ø	20 mm	25 mm
For cable cross-sections	16 ... 120 mm <sup>2</sup>	16 ... 150 mm <sup>2</sup>
Max. short-circuit current I <sub>k</sub> 0.5 s	33.5 kA	42.0 kA
Max. short-circuit current I <sub>k</sub> 1 s	23.7 kA	29.6 kA

*The clamps must have the same maximum short-circuit current as the earthing and short-circuiting cables!*

## Earth Connecting Elements – Earth Connectors

Safety Equipment

Earth Connecting Elements



Earth connector with wing bolt

- To be fitted to the earth cable end for connection to M12/M16 connectors or ring groove (Ø16 mm)
- Wing bolt or tommy bar
- Anti-rotation cable lug of type PK1 / PK2
- Earthing and short-circuiting devices can be configured online by means of the earthing and short-circuiting configurator

### General Information:

Standard	EN/IEC 61230 (DIN VDE 0683 Part 100)
Temperature range	- 25 °C ... + 55 °C
Material (terminal lug)	E-Cu/gal Sn
Material (wing nut)	Copper alloy/gal Sn

**EaS Configurator:**  
[www.dehn.de/en/euk](http://www.dehn.de/en/euk)

### Earth Connector with Wing Nut



Type	EAS EK FM 12	EAS EK FM 16
Part No.	775 621	775 631
Dimensions	M12	M16
Anti-rotation cable lug	PK1	PK1
For cable cross-sections	16 ... 150 mm <sup>2</sup>	16 ... 150 mm <sup>2</sup>
Max. short-circuit current I <sub>k</sub> 0.5 s	42.0 kA	42.0 kA
Max. short-circuit current I <sub>k</sub> 1 s	29.6 kA	29.6 kA

### Earth Connector with Wing Bolt



Type	EAS EK FS 12	EAS EK FS 16
Part No.	775 626	775 636
Dimensions	M12 x 15 mm	M16 x 15 mm
Anti-rotation cable lug	PK1	PK1
For cable cross-sections	16 ... 150 mm <sup>2</sup>	16 ... 150 mm <sup>2</sup>
Max. short-circuit current I <sub>k</sub> 0.5 s	42.0 kA	42.0 kA
Max. short-circuit current I <sub>k</sub> 1 s	29.6 kA	29.6 kA

### Earth Bushing with Wing Bolt

For fixed earthing points with ring groove



Type	EAB RN 16 FS
Part No.	790 150
Dimensions	Ø16 mm
Anti-rotation cable lug	PK1
For cable cross-sections	16 ... 150 <sup>*)</sup> mm <sup>2</sup>
Max. short-circuit current I <sub>k</sub> 0.5 s	42.0 kA
Max. short-circuit current I <sub>k</sub> 1 s	29.6 kA

<sup>\*)</sup> For cable lengths > 4000 mm: max. up to 95 mm<sup>2</sup> (26.5 kA / 0.5 s)

### Earth Bushing with Tommy Bar

For fixed earthing points with ring groove



Type	EAB RN 16 SKN
Part No.	790 160
Dimensions	Ø16 mm
Anti-rotation cable lug	PK2
For cable cross-sections	16 ... 150 <sup>**)</sup> mm <sup>2</sup>
Max. short-circuit current I <sub>k</sub> 0.5 s	29.6 kA
Max. short-circuit current I <sub>k</sub> 1 s	29.6 kA

<sup>\*\*)</sup> Max. short-circuit current of 29.6 kA even in case of I<sub>k</sub> 1 s

*The clamps must have the same maximum short-circuit current as the earthing and short-circuiting cables!*

## Earth Connecting Elements

- To be fitted to the earth cable end for connection to flat profiles up to 40 mm
- Milling plate, disc springs and long tommy bar for reliable contact
- Anti-rotation cable lug of type PK1
- Earthing and short-circuiting devices can be configured online by means of the earthing and short-circuiting configurator

EaS Configurator:  
[www.dehn.de/en/euk](http://www.dehn.de/en/euk)



Earth milling clamp used on a coated steel tower

**General Information:**

Standard	EN/IEC 61230 (DIN VDE 0683 Part 100)
Temperature range	- 25 °C ... + 55 °C
Material (clamp body)	MCl/gal Zn
Material (shaft)	Brass/gal Zn
Material (milling plate)	St, hardened/chrome-plated
Material (spring)	Spring steel

## Earth Milling Clamp with Tommy Bar and Disc Springs



Type	EFK FL40 SKN
Part No.	792 190
Clamping range	Up to 40 mm
For cable cross-sections	25 ... 95 mm <sup>2</sup>
Max. short-circuit current $I_k$ 0.5 s	26.5 kA
Max. short-circuit current $I_k$ 1 s	18.7 kA

## Earth Milling Clamp with Tommy Bar



Type	EFK FL30 SKN
Part No.	792 030
Clamping range	Up to 30 mm
For cable cross-sections	25 ... 50 mm <sup>2</sup>
Max. short-circuit current $I_k$ 0.5 s	14.0 kA
Max. short-circuit current $I_k$ 1 s	9.9 kA

*The clamps must have the same maximum short-circuit current ( $I_k$  0.5 s or  $I_k$  1 s) as the earthing and short-circuiting cables!*



## Single-Part Earthing Sticks for Switchgear Installations

Safety Equipment

Earthing Sticks



Earthing stick used for attaching an earthing and short-circuiting device to an installation

### General Information:

Standard	T pin shaft DIN 48087
Temperature range	- 25 °C ... + 55 °C
Material (insulating tube)	Glass-fibre reinforced polyester tube
End fitting	Non-slip plastic cap or plug-in coupling for extending the handle



The plug-in coupling allows for easy handle extension of ES STK earthing sticks.

- For attaching earthing and short-circuiting devices
- Available in different lengths
- Light-weight construction
- Hexagon shaft (width across flats 19 mm) or T pin shaft

**Earthing sticks** are hand-held insulating sticks for approaching clamps of earthing and short-circuiting devices to parts of electrical installations for earthing and short-circuiting purposes.

They consist of an insulating element, black ring, handle and coupling for attaching clamps. Earthing sticks have to be selected according to the **weight** of the earthing and short-circuiting device (see also "max. load on the operating head in kg").

The **insulating element** is the part of the earthing stick between the black ring and the end of the earthing stick in the direction of the connecting component. It ensures that the user maintains the required safety distance and provides sufficient insulation. In installations exceeding 1 kV, the insulating element must have a minimum length of 500 mm.



Earthing sticks with bayonet locking mechanism (T pin shaft) can also be used for clamps with hexagon shafts by attaching an AES SQ SK adapter is used.



## Safety Equipment

## Single-Part Earthing Sticks for Switchgear Installations

## Earthing Sticks

## Earthing Stick, hexagon Shaft

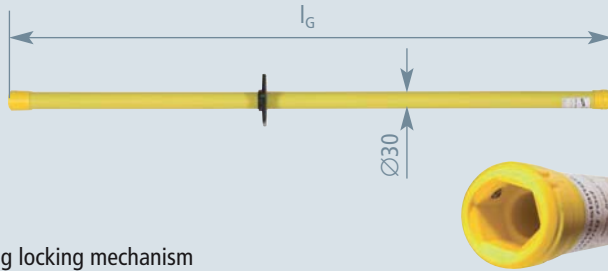

Spring locking mechanism

Type	ES SK 1000	ES SK 1500
Part No.	761 010	761 015
Total length ( $l_G$ )	1000 mm	1500 mm
Length (handle) ( $l_H$ )	430 mm	930 mm
Max. load on the operating head	35 kg	35 kg

## Earthing Stick, T Pin Shaft

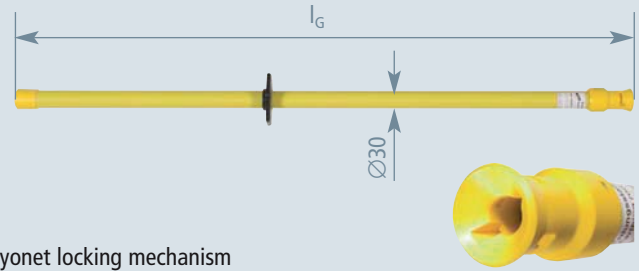

Bayonet locking mechanism

Type	ES SQ 1000	ES SQ 1500
Part No.	761 011	761 016
Total length ( $l_G$ )	1000 mm	1500 mm
Length (handle) ( $l_H$ )	430 mm	930 mm
Max. load on the operating head	35 kg	35 kg

## Earthing Stick, hexagon Shaft, plug-in Coupling

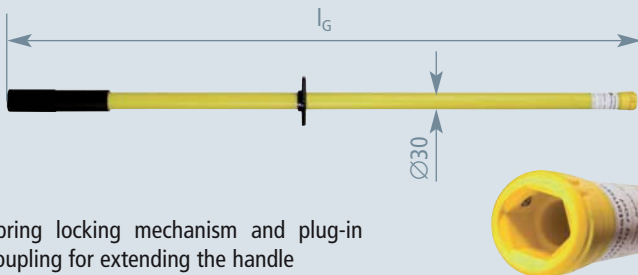

Spring locking mechanism and plug-in coupling for extending the handle

Type	ES SK STK 1000	ES SK STK 2000
Part No.	761 001	761 003
Total length ( $l_G$ )	1000 mm	2000 mm
Length (handle) ( $l_H$ )	430 mm	1430 mm
Max. load on the operating head	35 kg	20 kg

## Earthing Stick, T Pin Shaft, plug-in Coupling

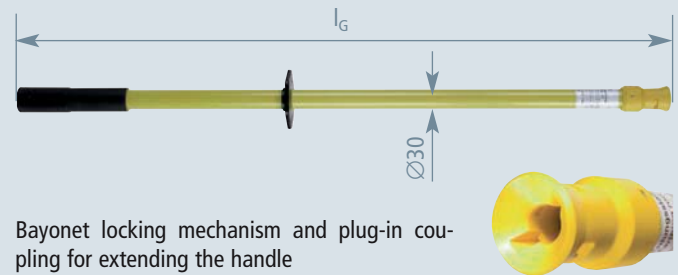

Bayonet locking mechanism and plug-in coupling for extending the handle

Type	ES SQ STK 1000	ES SQ STK 2000
Part No.	761 002	761 004
Total length ( $l_G$ )	1000 mm	2000 mm
Length (handle) ( $l_H$ )	430 mm	1430 mm
Max. load on the operating head	35 kg	20 kg

## Accessory for Single-Part Earthing Sticks for Switchgear Installations

## Adapter with hexagon Shaft / T Pin Shaft

Suitable for insertion into earthing sticks with coupling for T pin shafts (bayonet locking mechanism) to accept clamps with hexagon shaft.

The lock nut allows to fix the adapter on the earthing stick.

Type	AD ES SQ SK
Part No.	765 001
Length	130 mm

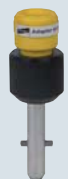

## Two-Part Earthing Sticks for Switchgear Installations

Safety Equipment

Earthing Sticks



- For attaching earthing and short-circuiting devices
- Modular for easy transport
- Light-weight construction
- Hexagon shaft (width across flats 19) or T pin shaft



### General Information:

Standard	T pin shaft DIN 48087
Temperature range	- 25 °C ... + 55 °C
Material (insulating tube)	Glass-fibre reinforced polyester tube
End fitting	Plug-in coupling for extending the handle

### Earthing Stick, hexagon Shaft

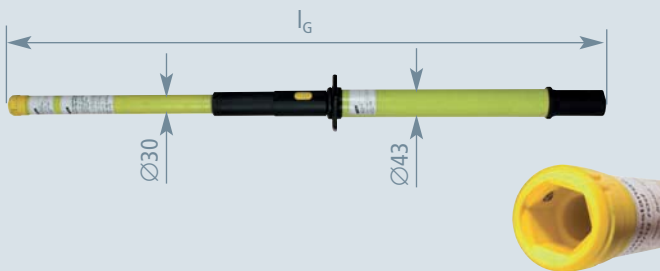

Spring locking mechanism and plug-in coupling for extending the handle

Type	EST SK STK 920
Part No.	761 070
Total length (l <sub>G</sub> )	920 mm
Handle length (l <sub>H</sub> )	415 mm
Max. load on the operating head	35 kg

### Earthing Stick, T Pin Shaft

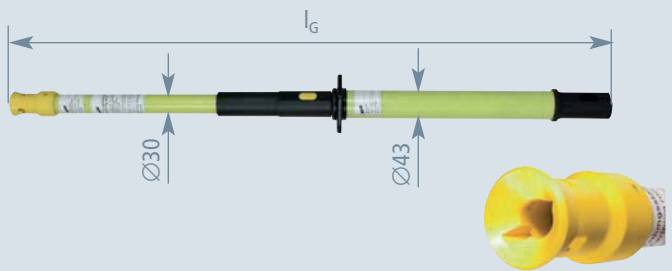

Bayonet locking mechanism and plug-in coupling for extending the handle

Type	EST SQ STK 920
Part No.	761 075
Total length (l <sub>G</sub> )	920 mm
Handle length (l <sub>H</sub> )	415 mm
Max. load on the operating head	35 kg

## Safety Equipment

## Earthing Sticks

- For use in outdoor installations
- Robust aluminium cone coupling
- Telescopic stick, length gradually adjustable
- For phase screw clamps and clamps with long T pin shaft



Earthing stick with aluminium cone coupling used for clamps with long shaft in accordance with DIN 48087.

A square tube (26 mm) can be pulled out of the round insulating tube and can be fixed in any position between  $l_{\min}$  and  $l_{\max}$  using the star-shaped handle.



End fitting with eye (Al/rubber) or plug-in coupling with eye (Al/rubber) for extending the handle

**Lockable adjusting ring**

The adjusting ring on the cone has the following functions:

- Position "AUF" (= OPEN): Stick can be removed from the clamp after the earthing and short-circuiting device has been attached
- Position "ZU" (= CLOSED): Stick and clamp remain coupled even after the earthing and short-circuiting device has been attached

## Telescopic Earthing Sticks for Overhead Lines



Telescopic earthing stick with aluminium cone coupling and phase screw clamp

**General Information:**

Temperature range	– 25 °C ... + 55 °C
Material (insulating tube)	Glass-fibre reinforced polyester tube
Material (threaded coupling, star-shaped handle)	Aluminium alloy
End fitting	Aluminium/rubber eye / Plug-in coupling for extending the handle

## Telescopic Earthing Sticks for Overhead Lines

Safety Equipment

## Telescopic Earthing Stick, T Pin Shaft

Earthing Sticks

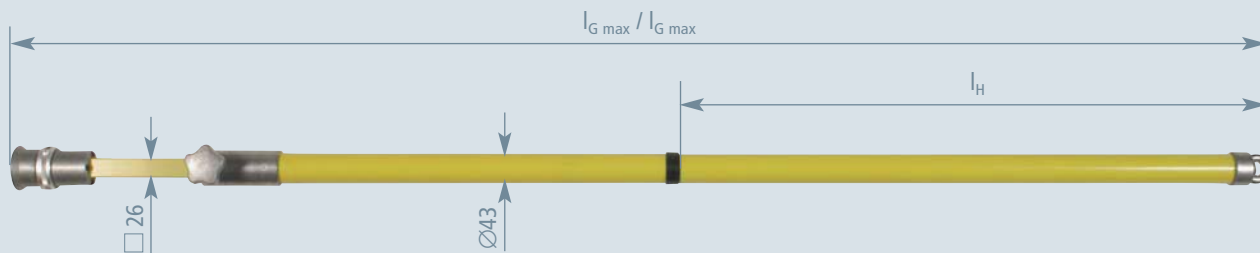

Type	ESTC SQL 4000	ESTC SQL 5000
Part No.	769 400	769 500
Total length ( $l_{G \max} / l_{G \min}$ )	4000 / 2170 mm	5000 / 2670 mm
Length (handle) ( $l_H$ )	1400 mm	1900 mm
Max. load on the operating head ( $l_{\max} / l_{\min}$ )	12 / 35 kg	10 / 35 kg

## Telescopic Earthing Stick, T Pin Shaft, plug-in Coupling

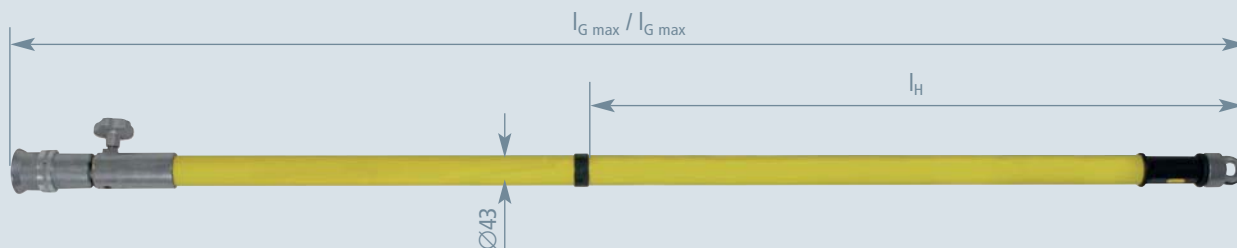

Type	ESTC SQL STK 3000
Part No.	769 300
Total length ( $l_{G \max} / l_{G \min}$ )	3000 / 1670 mm
Length (handle) ( $l_H$ )	900 mm
Max. load on the operating head ( $l_{\max} / l_{\min}$ )	18 / 35 kg

## Earthing Sticks

- For outdoor use
- Robust aluminium cone coupling
- Positive and non-positive threaded coupling
- Transport length of 1500 mm
- Total lengths up to 6000 mm
- For phase screw clamps and clamps with long T pin shaft



Earthing stick consisting of a top section, intermediate section and end fitting



Robust aluminium threaded coupling allows positive and non-positive connection due to the screw connection and gearing

**Lockable adjusting ring**

The adjusting ring on the cone has the following functions:

- Position "AUF" (= OPEN): Stick can be removed from the clamp after the earthing and short-circuiting device has been attached
- Position "ZU" (= CLOSED): Stick and clamp remain coupled even after the earthing and short-circuiting device has been attached

**General Information:**

Temperature range	– 25 °C ... + 55 °C
Material (insulating tube)	Glass-fibre reinforced polyester tube
Material (threaded coupling)	Aluminium alloy
Material (end fitting)	Al/rubber eye



## Multi-Part Earthing Sticks for Overhead Lines

Safety Equipment

Earthing Sticks

### Possible combinations:

- Top section (1) only
- Top section (1) + end fitting (3)
- Top section (1) + max. 2 intermediate sections (2) + end fitting (3)

### Load values for extendible earthing sticks:

Total length $l_G$	Pos. No.	Max. load on operating head
6000 mm	1+2+2+3	8 kg
4500 mm	1+2+3	15 kg
3000 mm	1+3	30 kg
1500 mm	1	35 kg

### Telescopic Earthing Stick – Top Section

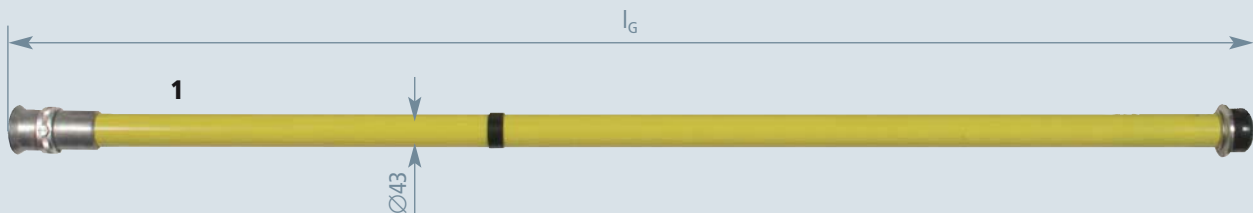

With plastic cap above the coupling element

<b>Type</b>	<b>EST KS SQL 1500</b>
<b>Part No.</b>	<b>769 503</b>
Diameter	43 mm
Total length ( $l_G$ )	1500 mm

### Telescopic Earthing Stick – Intermediate Section

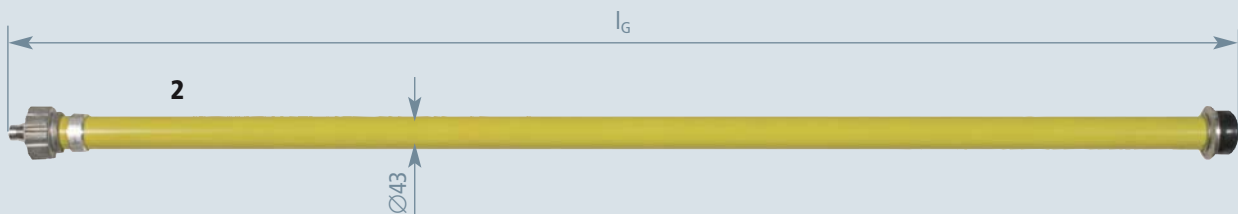

With plastic cap above the coupling element

<b>Type</b>	<b>EST ZS 1500</b>
<b>Part No.</b>	<b>769 504</b>
Diameter	43 mm
Total length ( $l_G$ )	1500 mm

### Telescopic Earthing Stick – End Fitting

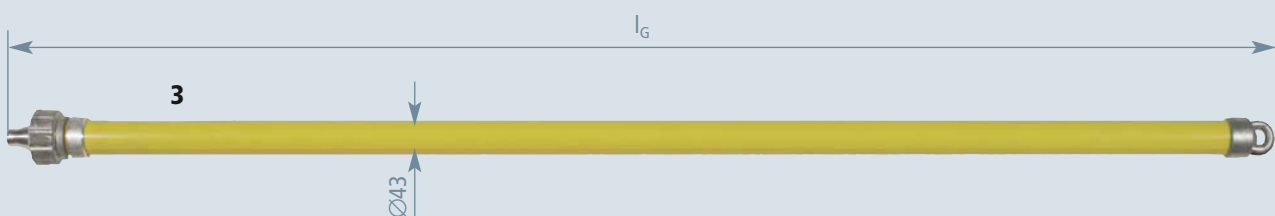

With aluminium / rubber eye

<b>Type</b>	<b>EST ES 1500</b>
<b>Part No.</b>	<b>769 505</b>
Diameter	43 mm
Total length ( $l_G$ )	1500 mm

## Template for portable Earthing and Short-circuiting devices (EaS)

acc. to IEC/EN 61230 (DIN VDE 0683-100)





EaS Configurator:  
www.dehn.de/en/euk

<b>Customer:</b>	
Customer No.:	
Company:	
Address:	
Address, country:	
Contact:	
Phone / fax:	E-Mail:
<input type="checkbox"/> Enquiry	<input type="checkbox"/> Order
Quantity:	pc(s).
Signature:	

## 1 For use with:

 Switchgear Installations
  Overhead Lines

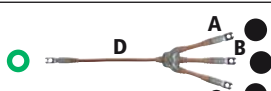
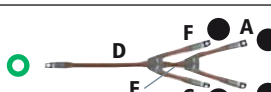
## 2 Earthing and Short-circuiting device:

<input type="checkbox"/> 1-pole		<input checked="" type="checkbox"/> Same cable cross-section
<input type="checkbox"/> 2-pole		<input checked="" type="checkbox"/> Same cable cross-section
<input type="checkbox"/> 3-pole		<input type="checkbox"/> Same cable cross-section <input type="checkbox"/> Reduced cable cross-section ( $\geq 50 \text{ mm}^2$ )
<input type="checkbox"/> 4-pole		<input checked="" type="checkbox"/> Same cable cross-section
<input type="checkbox"/> 5-pole		<input checked="" type="checkbox"/> Same cable cross-section

3 Cross-section of the copper cable:	Max. short-circuit current $I_k$ for a duration of	
	$\leq 0.5 \text{ s}$	1 s
<input type="checkbox"/> 16 mm <sup>2</sup>	4.5 kA	3.2 kA
<input type="checkbox"/> 25 mm <sup>2</sup>	7.0 kA	4.9 kA
<input type="checkbox"/> 35 mm <sup>2</sup>	10.0 kA	6.9 kA
<input type="checkbox"/> 50 mm <sup>2</sup>	14.0 kA	9.9 kA
<input type="checkbox"/> 70 mm <sup>2</sup>	19.5 kA	13.8 kA
<input type="checkbox"/> 95 mm <sup>2</sup>	26.5 kA	18.7 kA
<input type="checkbox"/> 120 mm <sup>2</sup>	33.5 kA	23.7 kA
<input type="checkbox"/> 150 mm <sup>2</sup>	42.0 kA	29.6 kA

## 4 Cable lengths:

A	mm	From: 200 up to 6000 mm at intervals of 50 mm
B	mm	From: 200 up to 6000 mm at intervals of 50 mm
C	mm	From: 200 up to 6000 mm at intervals of 50 mm
D	mm	From: 250 up to 25000 mm at intervals of 50 mm
E	mm	From: 150 up to 6000 mm at intervals of 50 mm
F	mm	From: 200 up to 6000 mm at intervals of 50 mm
G	mm	From: 200 up to 6000 mm at intervals of 50 mm

## 5 ● Phase connecting element (see easy choice):

Type or  
Part No.

## 6 ● Earth connecting element (see easy choice):

Type or  
Part No.







## 7 Accessory (optional) (see easy choice):

 Earthing stick
  Type or  
Part No.

## Easy Choice – Phase Connecting Elements and Earthing Sticks

Safety Equipment







## Phase Connecting Elements for Switchgear Installations:

Design	Type	Part No.	Clamping range	Collar width	Rd / Fl	Max. cable cross-section	Max. short-circuit current	Max. short-circuit current
			∅	Clamping range	Clamping range		$I_k$ 0.5 s	$I_k$ 1 s
	KKH 20 D SK	772 330	∅20 mm	–	–	16-120 mm <sup>2</sup>	33.5 kA	23.7 kA
	KKH 20 D SQ	772 331	∅20 mm	–	–	16-120 mm <sup>2</sup>	33.5 kA	23.7 kA
	KKH 20 SK	772 310	∅20 mm	–	–	16-120 mm <sup>2</sup>	33.5 kA	23.7 kA
	KKH 20 SQ	772 311	∅20 mm	–	–	16-120 mm <sup>2</sup>	33.5 kA	23.7 kA
	KKH 25 D SK	772 340	∅25 mm	–	–	16-150 mm <sup>2</sup>	42.0 kA	29.6 kA
	KKH 25 D SQ	772 341	∅25 mm	–	–	16-150 mm <sup>2</sup>	42.0 kA	29.6 kA
	KKH 25 SK	772 320	∅25 mm	–	–	16-150 mm <sup>2</sup>	42.0 kA	29.6 kA
	KKH 25 SQ	772 321	∅25 mm	–	–	16-150 mm <sup>2</sup>	42.0 kA	29.6 kA
	UK 25 SK	773 034	∅20/25 mm	15 mm (-95 mm <sup>2</sup> )	20 mm (-70 mm <sup>2</sup> )	16-120 mm <sup>2</sup>	33.5 kA	23.7 kA
	UK 25 SQ	773 234	∅20/25 mm	15 mm (-95 mm <sup>2</sup> )	20 mm (-70 mm <sup>2</sup> )	16-120 mm <sup>2</sup>	33.5 kA	23.7 kA
	UK 30 SK	773 130	∅25/30 mm	18 mm (-95 mm <sup>2</sup> )	30 mm (-70 mm <sup>2</sup> )	16-120 mm <sup>2</sup>	33.5 kA	23.7 kA
	UK 30 SQ	773 330	∅25/30 mm	18 mm (-95 mm <sup>2</sup> )	30 mm (-70 mm <sup>2</sup> )	16-120 mm <sup>2</sup>	33.5 kA	23.7 kA

## Earthing Sticks for Switchgear Installations:

Design	Type	Part No.	Length $l_G$	Max. load on operating head	Design	Type	Part No.	Length $l_G$	Max. load on operating head
	ES SK 1000	761 010	1000 mm	35 kg		ES SQ 1000	761 011	1000 mm	35 kg
	ES SK 1500	761 015	1500 mm	35 kg		ES SQ 1500	761 016	1500 mm	35 kg
	ES SK STK 1000	761 001	1000 mm	35 kg		ES SQ STK 1000	761 002	1000 mm	35 kg
	ES SK STK 2000	761 003	2000 mm	20 kg		ES SQ STK 2000	761 004	2000 mm	20 kg
	ES SK STK 920	761 070	920 mm	35 kg		ES SQ STK 920	761 075	920 mm	35 kg

## Phase Connecting Elements for Overhead Lines:





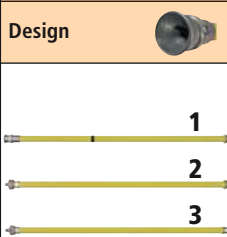
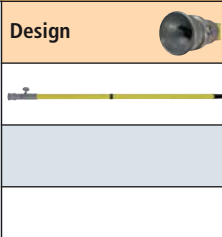







Design	Type	Part No.	Clamping range	Collar width	Rd / Fl	Max. cable cross-section	Max. short-circuit current	Max. short-circuit current
			∅	Clamping range	Clamping range		$I_k$ 0.5 s	$I_k$ 1 s
	PSK 4 30 SQL	784 201	–	–	∅4-30 mm	16-70 mm <sup>2</sup>	19.5 kA	13.8 kA
	PSK 10 65 SQL	784 301	–	–	∅10-65 mm	16-120 mm <sup>2</sup>	33.5 kA	23.7 kA
	PSK 4 30 SQL EH	784 401	–	–	∅4-30 mm	16-70 mm <sup>2</sup>	19.5 kA	13.8 kA
	PSK 10 65 SQL EH	784 501	–	–	∅10-65 mm	16-120 mm <sup>2</sup>	33.5 kA	23.7 kA
	PSK FV 4 30 SQL	784 480	–	–	∅4-30 mm	16-70 mm <sup>2</sup>	19.5 kA	13.8 kA
	PSK 10 85 SQL	784 085	–	–	∅10-85 mm	16-150 mm <sup>2</sup>	29.6 kA	29.6 kA
	PSK 10 32 SQL	784 032	–	–	∅10-32 mm	16-95 mm <sup>2</sup>	18.7 kA	18.7 kA
	PSK 10 32 SQL SB	784 038	–	–	∅10-32 mm	16-95 mm <sup>2</sup>	18.7 kA	18.7 kA
	KKH 20 SQL	772 314	∅20 mm	–	–	16-120 mm <sup>2</sup>	33.5 kA	23.7 kA
	KKH 25 SQL	772 324	∅25 mm	–	–	16-150 mm <sup>2</sup>	42.0 kA	29.6 kA
	UK 25 SQL	773 236	∅20/25 mm	15 mm (-95 mm <sup>2</sup> )	20 mm (-70 mm <sup>2</sup> )	16-120 mm <sup>2</sup>	33.5 kA	23.7 kA
	UK 30 SQL	773 331	∅25/30 mm	18 mm (-95 mm <sup>2</sup> )	30 mm (-70 mm <sup>2</sup> )	16-120 mm <sup>2</sup>	33.5 kA	23.7 kA

## Earthing Sticks for Overhead Lines:

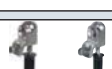

Design	Type	Part No.	Length $l_G$	Max. load on operating head	Design	Type	Part No.	Length $l_{G \max} / l_{G \min}$	Max. load on operating head	
	EST KS SQL 1500 Pos. No. 1	1x 769 503	1500 mm	35 kg		ESTC SQL STK 3000	769 300	3000 mm / 1670 mm	18 / 35 kg	
	Pos. No. 1 + 3	1x 769 503 1x 769 504	3000 mm	30 kg						
	Pos. No. 1 + 2 + 3	1x 769 503 1x 769 504 1x 769 505	4500 mm	15 kg			ESTC SQL 4000	769 400	4000 mm / 2170 mm	12 / 35 kg
	Pos. No. 1 + 2 + 2 + 3	1x 769 503 2x 769 504 1x 769 505	6000 mm	8 kg			ESTC SQL 5000	769 500	5000 mm / 2670 mm	10 / 35 kg

## Safety Equipment

## Easy Choice – Earth Connecting Elements

Earth Connecting Elements:								
Design	Type	Part No.	Clamping range Ø	Collar width Clamping range	Rd / Fl Clamping range	Max. cable cross-section	Max. short- circuit current	Max. short- circuit current
							$I_k$ 0.5 s	$I_k$ 1 s
 *	UEK 25 FS	774 034	Ø20/25 mm	15 mm (-95 mm <sup>2</sup> )	20 mm (-70 mm <sup>2</sup> )	16-120 mm <sup>2</sup>	33.5 kA	23.7 kA
	UEK 30 FS	774 130	Ø25/30 mm	18 mm (-95 mm <sup>2</sup> )	30 mm (-70 mm <sup>2</sup> )	16-120 mm <sup>2</sup>	33.5 kA	23.7 kA
 *	UEK 25 HG	774 234	Ø20/25 mm	15 mm (-95 mm <sup>2</sup> )	20 mm (-70 mm <sup>2</sup> )	16-120 mm <sup>2</sup>	33.5 kA	23.7 kA
	UEK 30 HG	774 330	Ø25/30 mm	18 mm (-95 mm <sup>2</sup> )	30 mm (-70 mm <sup>2</sup> )	16-120 mm <sup>2</sup>	33.5 kA	23.7 kA
 *	UEK 25 SKN	774 434	Ø20/25 mm	15 mm (-95 mm <sup>2</sup> )	20 mm (-70 mm <sup>2</sup> )	16-120 mm <sup>2</sup>	33.5 kA	23.7 kA
	UEK 30 SKN	774 530	Ø30 mm	18 mm (-95 mm <sup>2</sup> )	30 mm (-70 mm <sup>2</sup> )	16-120 mm <sup>2</sup>	33.5 kA	23.7 kA
	KKH 20 FS	772 312	Ø20 mm	–	–	16-120 mm <sup>2</sup>	33.5 kA	23.7 kA
	KKH 25 FS	772 322	Ø25 mm	–	–	16-150 mm <sup>2</sup>	42.0 kA	29.6 kA
	KKH 20 HG	772 313	Ø20 mm	–	–	16-120 mm <sup>2</sup>	33.5 kA	23.7 kA
	KKH 25 HG	772 323	Ø25 mm	–	–	16-150 mm <sup>2</sup>	42.0 kA	29.6 kA
Design	Type	Part No.	Dimensions		Clamping range Fl 	Max. cable cross-section	Max. short- circuit current $I_k$ 0.5 s	Max. short- circuit current $I_k$ 1 s
	EAS EK FM 12	775 621	M12		–	16-150 mm <sup>2</sup>	42.0 kA	29.6 kA
	EAS EK FM 16	775 631	M16		–	16-150 mm <sup>2</sup>	42.0 kA	29.6 kA
	EAS EK FS 12	775 626	M12 x 15 mm		–	16-150 mm <sup>2</sup>	42.0 kA	29.6 kA
	EAS EK FS 16	775 636	M16 x 15 mm		–	16-150 mm <sup>2</sup>	42.0 kA	29.6 kA
	EAB RN 16 FS	790 150	Ø16 mm		–	16-150 mm <sup>2</sup>	42.0 kA	29.6 kA
	EAB RN 16 SKN	790 160	Ø16 mm		–	16-150 mm <sup>2</sup>	29.6 kA	29.6 kA
	EFK FL40 SKN	792 190	–		40 mm	16-95 mm <sup>2</sup>	26.5 kA	18.7 kA
	EFK FL30 SKN	792 030	–		30 mm	16-50 mm <sup>2</sup>	14.0 kA	9.9 kA







## \*) Clamping range and maximum cable cross-section of universal clamps used for:

Fixed ball point Ø	Phase T Pin Collar width	Rd / Fl Clamping range	Max. cable cross- section	Max. short- circuit current	Max. short- circuit current
				$I_k$ 0.5 s	$I_k$ 1 s
20 / 25 / 30 mm	15 / 18 mm	20 / 30 mm	16 mm <sup>2</sup>	4.5 kA	3.2 kA
20 / 25 / 30 mm	15 / 18 mm	20 / 30 mm	25 mm <sup>2</sup>	7.0 kA	4.9 kA
20 / 25 / 30 mm	15 / 18 mm	20 / 30 mm	35 mm <sup>2</sup>	10.0 kA	6.9 kA
20 / 25 / 30 mm	15 / 18 mm	20 / 30 mm	50 mm <sup>2</sup>	14.0 kA	9.9 kA
20 / 25 / 30 mm	15 / 18 mm	20 / 30 mm	70 mm <sup>2</sup>	19.5 kA	13.8 kA
20 / 25 / 30 mm	15 / 18 mm	–	95 mm <sup>2</sup>	26.5 kA	18.7 kA
– / 25 / 30 mm	–	–	120 mm <sup>2</sup>	33.5 kA	23.7 kA
–	–	–	150 mm <sup>2</sup>	42.0 kA	29.6 kA



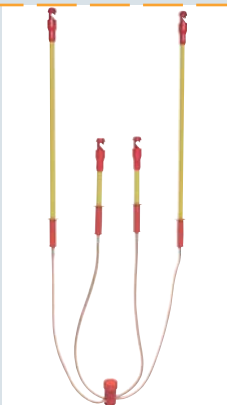

## Equipment for Voltages up to 1000 V

Device	Nominal voltage $U_N$	Application	Page	
<b>Earthing and Short-circuiting Device, fully insulated, Type VI</b>	up to 1000 V	Fully insulated, shock-proof version Earthing cartridges with T connection Fully equipped kit for cable distribution cabinets	114	
<b>Earthing and Short-circuiting Device, partly insulated, Type TI</b>	up to 1000 V	Earthing cartridges with M10 connection Screw-in earthing insert for D-type fuse links Fully equipped kit for cable distribution cabinets	116	
<b>Earthing and Short-circuiting Device</b> For crane conductor bars	up to 1000 V	Allows to lock the clamping range For insulated or uninsulated conductor bars	119	
<b>Earthing and Short-circuiting Device</b> For overhead lines up to $\varnothing 12$ mm	up to 1000 V	Insulated clamps for overhead conductors 4-pole version, extendible up to 6 poles Reliable conductivity due to a copper bar in the insulating tube	120	
<b>Earthing and Short-circuiting Device</b> For street lighting systems	up to 1000 V	For D-type fuse links of junction and fuse boxes of street lighting systems Fully equipped kit	121	
<b>Earthing Handle</b>	up to 1000 V	For applying earthing and short-circuiting devices in low-voltage installations End fitting with plug-in coupling for handle extension Light-weight construction Hexagon shaft or T pin shaft	122	
<b>SPN</b> <b>Two-pole Voltage Detector</b>	100 ... 500 V 120 ... 1000 V	For use in wet weather conditions 2 versions with different measuring ranges No batteries required Can also be used in overhead line networks by attaching extension prods	123	
<b>Storage Bags and Transport Cases</b>		Sheet metal or plastic case Artificial leather or canvas bag	187	

## Three-pole Earthing and Short-Circuiting Kit VI

Safety Equipment

Kit for low-voltage installations, fully insulated type VI

Equipment for Voltages up to 1000 V



Attaching a fully insulated earthing and short-circuiting device using an earthing handle of type VI

- Fully insulated, shock-proof version
- Fully equipped kit for cable distribution cabinets
- Safe operation with insulated earthing handle of type VI (with dual function), suitable for both inserting and removing earthing cartridges with T connection as well as for attaching earthing and short-circuiting devices (EaS devices)
- Waterproof, plastic-sheathed cable entry and node unit, additionally protected against twisting
- Other cable lengths can be selected online via the earthing and short-circuiting configurator

**EaS Configurator:**  
[www.dehn.de/en/euk](http://www.dehn.de/en/euk)

### General Information:

Standard	EN/IEC 61230 (DIN VDE 0683 Part 100)
Temperature range	- 25 °C ... + 55 °C

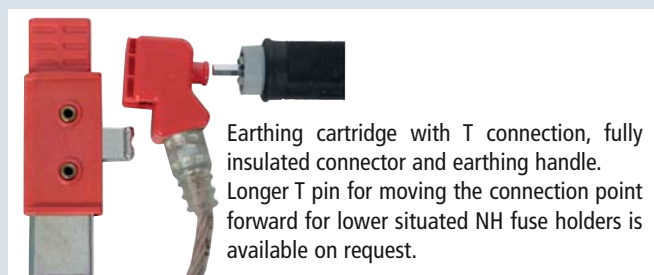

Earthing cartridge with T connection, fully insulated connector and earthing handle. Longer T pin for moving the connection point forward for lower situated NH fuse holders is available on request.

### Kit in plastic Case



Type	EKS VI 2F KVS KK
Part No.	745 903
Variant No. of the earthing and short-circuiting device	V162LDM
Dimensions	445 x 345 x 100 mm

Note: When ordering please specify the Variant No.

### Kit in Sheet Metal Case

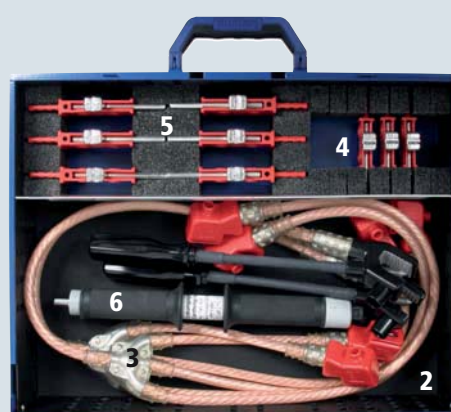

Type	EKS VI 2F KVS SBK
Part No.	745 901
Variant No. of the earthing and short-circuiting device	V162LDM
Dimensions	440 x 330 x 100 mm

Note: When ordering please specify the Variant No.

## Safety Equipment

### Equipment for Voltages up to 1000 V

#### Plastic Case, empty

With foam padding

Type	KKL EKS VI KVS
Part No.	745 902
Dimensions	445 x 345 x 100 mm



#### Earthing and Short-Circuiting Device VI, Earth Clamp with flexible adjustable Handle

Adjustable handle with two positions, clamping range up to 20 mm, for cable distribution cabinets

Type	EKV3 25VI DG	EKV3 35VI DG
Part No.	745 325	745 335
Variant No.	V162LDM	VE5K3HM
Cable cross-section	25/25 mm <sup>2</sup>	35/35 mm <sup>2</sup>
Max. short-circuit current I <sub>k</sub> 0.5 s	7.0 kA	10.0 kA
Max. short-circuit current I <sub>k</sub> 1 s	4.9 kA	6.9 kA

Note: When ordering please specify the Variant No.

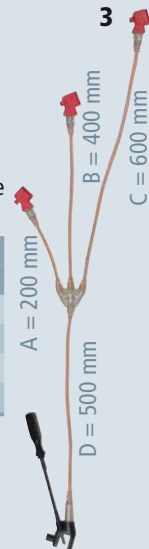

#### Earthing and Short-Circuiting Device VI, spring-loaded Earth Clamp

Clamping range up to 24 mm, installation via adjustable handle (Part No. 745 921), for service entrance boxes

Type	EKV3 16VI EK
Part No.	745 340
Variant No.	VZPW9LG
Cable cross-section	16/16 mm <sup>2</sup>
Max. short-circuit current I <sub>k</sub> 0.5 s	4.5 kA
Max. short-circuit current I <sub>k</sub> 1 s	3.2 kA

Note: When ordering please specify the Variant No.

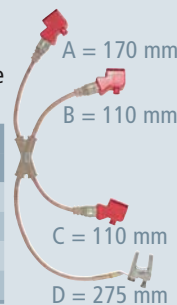

#### VI Earthing Handle

With dual function

- For installing earthing cartridges with T connection into NH fuse holders
- For connecting VI earthing and short-circuiting devices to earthing cartridges

Type	EG 00 4A VI
Part No.	745 922
Length	285 mm



#### Adjustable Handle with flexible Shaft

With magnetic socket wrench insert

For connecting spring-loaded earth clamps

Type	DGF EKV VI
Part No.	745 921
Length	290 mm



#### Plastic Case, empty

With foam padding and hook-and-loop fastener

Type	KK 56 41 17 EK VI TI
Part No.	745 952
Dimensions	565 x 410 x 170 mm



## Three-pole Earthing and Short-Circuiting Kit VI

### Kit Parts

#### Sheet Metal Case, empty

With foam padding

Type	SBKL EKS VI KVS
Part No.	745 900
Dimensions	440 x 330 x 100 mm



#### Earthing and Short-Circuiting Device VI, spring-loaded Earth Clamp

Clamping range up to 24 mm, installation via adjustable handle (Part No. 745 921), for cable distribution cabinets

Type	EKV3 25VI EK	EKV3 35VI EK
Part No.	745 326	745 336
Variant No.	VMRSJWD	VEH4JQY
Cable cross-section	25/25 mm <sup>2</sup>	35/35 mm <sup>2</sup>
Max. short-circuit current I <sub>k</sub> 0.5 s	7.0 kA	10.0 kA
Max. short-circuit current I <sub>k</sub> 1 s	4.9 kA	6.9 kA

Note: When ordering please specify the Variant No.



#### Spring-loaded compact Clamp

With T connection and hexagon bolt (width A/F 10) for installation via VI earthing handle and fixation via flexible shaft

Type	KK TA 0 24 SK10
Part No.	745 503
Clamping range	Up to 24 mm
Max. short-circuit current I <sub>k</sub> 0.5 s	10.0 kA
Max. short-circuit current I <sub>k</sub> 1 s	6.9 kA



#### NH 00 Earthing Cartridges

With T connection for installation into NH fuse holders and blocks of size NH 00

For use with VI earthing handle

Type	EP NH00 VI TA
Part No.	745 905
Size	00
Max. cable cross-section	35 mm <sup>2</sup>
Max. short-circuit current I <sub>k</sub> 0.5 s	10.0 kA
Max. short-circuit current I <sub>k</sub> 1 s	6.9 kA



#### NH 1 ... 3 Earthing Cartridges

With T connection for installation into NH fuse holders and blocks of size NH 1 ... 3

For use with VI earthing handle

Type	EP NH1 3 VI TA
Part No.	745 910
Size	1 ... 3
Max. cable cross-section	35 mm <sup>2</sup>
Max. short-circuit current I <sub>k</sub> 0.5 s	10.0 kA
Max. short-circuit current I <sub>k</sub> 1 s	6.9 kA



#### NH 4a Earthing Cartridges

Type	EP NH4A VI TA
Part No.	745 915
Size	4a
Max. cable cross-section	35 mm <sup>2</sup>
Max. short-circuit current I <sub>k</sub> 0.5 s	10.0 kA
Max. short-circuit current I <sub>k</sub> 1 s	6.9 kA





## Three-pole Earthing and Short-Circuiting Kit TI

Safety Equipment

Kit for low-voltage installations, partly insulated type TI

Equipment for Voltages up to 1000 V



Attaching a partly insulated earthing and short-circuiting device using an earthing handle of type TI

- Fully equipped kit for cable distribution cabinets
- Safe operation with insulated earthing handle of type TI (with dual function), suitable both for installing and removing earthing cartridges with M10 connection as well as for attaching earthing and short-circuiting devices (EaS devices)
- Waterproof, plastic-sheathed cable entry and node unit, additionally protected against twisting
- Other cable lengths can be selected online via the earthing and short-circuiting configurator

**EaS Configurator:**  
[www.dehn.de/en/euk](http://www.dehn.de/en/euk)

### General Information:

Standard	EN/IEC 61230 (DIN VDE 0683 Part 100)
Temperature range	- 25 °C ... + 55 °C

### Additional locking mechanism:

The claws of size 1 ... 3 earthing cartridges spread out when attaching the earthing and short-circuiting device to the NH fuse holder (increased short-circuit withstand capability).

Adapter for moving the connection point of the earthing cartridge forward for lower situated NH fuse holders is available on request.

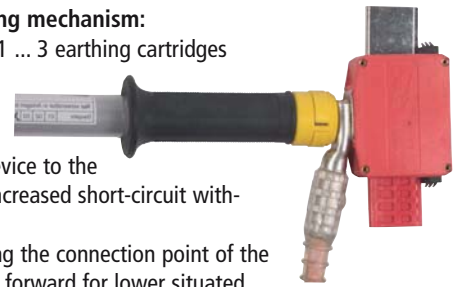

## Kit I in Sheet Metal Case

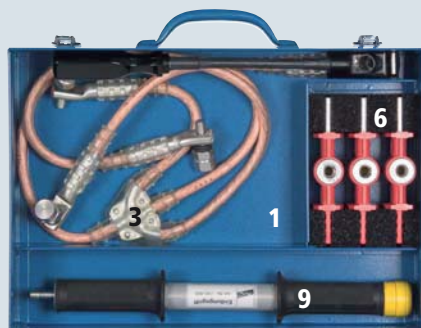

Type	EKS TI KVS SBK
Part No.	766 302
Variant No. of the earthing and short-circuiting device	VSUN6NV
Dimensions	380 x 260 x 80 mm

Note: When ordering please specify the Variant No.

## Kit II in Sheet Metal Case



Type	EKS TI 2F KVS SBK
Part No.	745 500
Variant No. of the earthing and short-circuiting device	VUKMT58
Dimensions	440 x 330 x 66 mm

Note: When ordering please specify the Variant No.

Other cable lengths or customised kits are available on request.

Safety Equipment

Equipment for Voltages up to 1000 V

Sheet Metal Case, empty

Type	SBKL EKS TI KVS
Part No.	766 300
Colour	Blue
Dimensions	380 x 260 x 80 mm



Earthing and Short-Circuiting Device TI, Earth Clamp with flexible adjustable Handle

Adjustable handle with two positions, clamping range up to 20 mm, for cable distribution cabinets

Type	EKV3 25TI DG	EKV3 35TI DG
Part No.	745 345	745 346
Variant No.	VSUN6NV	VSHDQZB
Cable cross-section	25/25 mm <sup>2</sup>	35/35 mm <sup>2</sup>
Max. short-circuit current I <sub>k</sub> 0.5 s	7.0 kA	10.0 kA
Max. short-circuit current I <sub>k</sub> 1 s	4.9 kA	6.9 kA

Note: When ordering please specify the Variant No.



Earthing and Short-Circuiting Device TI, spring-loaded Earth Clamp

Clamping range up to 24 mm and fixation via adjustable handle (Part No. 745 921), fixed earthing cartridges of size 00 on the phase cable end, for service entrance boxes

Type	EKV3 NH00 TI
Part No.	745 365
Variant No.	V1RC3P2
Cable cross-section	16/16 mm <sup>2</sup>
Max. short-circuit current I <sub>k</sub> 0.5 s	4.5 kA
Max. short-circuit current I <sub>k</sub> 1 s	3.2 kA

Note: When ordering please specify the Variant No.

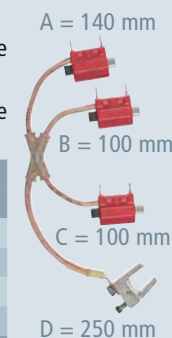

NH 00 Earthing Cartridges

With M10 connection for insertion into NH fuse holders and blocks of size NH 00

For use with TI earthing handle

Type	EP NH00 TI M10
Part No.	745 302
Size	00
Max. cable cross-section	35 mm <sup>2</sup>
Max. short-circuit current I <sub>k</sub> 0.5 s	10.0 kA
Max. short-circuit current I <sub>k</sub> 1 s	6.9 kA



NH 4a Earthing Cartridges

With M10 connection for insertion into NH fuse holders and blocks of size NH 4a

For use with TI earthing handle (Part No. 745 400/S03)

Type	EP NH4A TI M10
Part No.	745 016
Size	4a
Max. cable cross-section	35 mm <sup>2</sup>
Max. short-circuit current I <sub>k</sub> 0.5 s	10.0 kA
Max. short-circuit current I <sub>k</sub> 1 s	6.9 kA



Three-pole Earthing and Short-Circuiting Kit TI

Kit Parts

Sheet Metal Case, empty

With foam padding

Type	SBKL EKS TI KVS 2F
Part No.	766 298
Colour	Blue
Dimensions	440 x 330 x 66 mm



Earthing and Short-Circuiting Device TI with hook-shaped Cable Lug on the Earth Cable End

For installation of earth clamps Part No. 745 602 or 745 502, for cable distribution cabinets

Typ EKV3 ...	16TI HK	25TI HK	35TI HK
Part No.	745 358	745 359	745 360
Variant No.	V3RQASE	VUKMT58	VDZ2VDX
Cable cross-section	16/16 mm <sup>2</sup>	25/25 mm <sup>2</sup>	35/35 mm <sup>2</sup>
Max. short-circuit current I <sub>k</sub> 0.5 s	4.5 kA	7.0 kA	10.0 kA
Max. short-circuit current I <sub>k</sub> 1 s	3.2 kA	4.9 kA	6.9 kA

Note: When ordering please specify the Variant No.

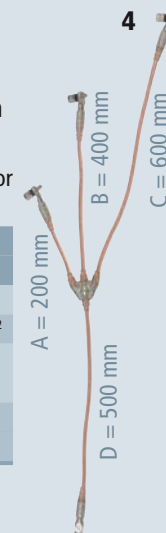

Earthing and Short-Circuiting Device TI, spring-loaded Earth Clamp

Clamping range up to 24 mm and fixation via adjustable handle (Part No. 745 921), screw-on cable lugs with M10 hexagon pin on the phase cable end, to be screwed onto earthing cartridges with M10 connection of service entrance boxes

Type	EKV3 16TI EK
Part No.	745 363
Variant No.	VS29AH
Cable cross-section	16/16 mm <sup>2</sup>
Max. short-circuit current I <sub>k</sub> 0.5 s	4.5 kA
Max. short-circuit current I <sub>k</sub> 1 s	3.2 kA

Note: When ordering please specify the Variant No.

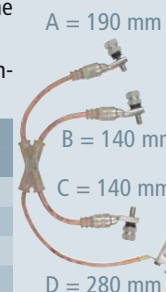

NH 1 ... 3 Earthing Cartridges

With M10 connection for insertion into NH fuse holders and blocks of size NH 1 ... 3

For use with TI earthing handle

Type	EP NH1 3 TI M10
Part No.	745 018
Size	1 ... 3
Max. cable cross-section	35 mm <sup>2</sup>
Max. short-circuit current I <sub>k</sub> 0.5 s	10.0 kA
Max. short-circuit current I <sub>k</sub> 1 s	6.9 kA



NH 1 ... 3 Earthing Cartridges with Grip Lugs

With M10 connection for use with TI earthing handle or NH fuse handle with sleeve (Part No. 785 645)

Type	EP NH1 3 TI GL M10
Part No.	745 017
Size	1 ... 3
Max. cable cross-section	35 mm <sup>2</sup>
Max. short-circuit current I <sub>k</sub> 0.5 s	10.0 kA
Max. short-circuit current I <sub>k</sub> 1 s	6.9 kA





## Three-pole Earthing and Short-Circuiting Kit TI

Safety Equipment

### Kit Parts

Equipment for Voltages up to 1000 V

#### Screw-in Earthing Insert with M10 Connection, insulated

Insulated thread

To be screwed into E27 and E33 threaded fuse holders using a TI earthing handle

Type	ESE E27 TI M10	ESE E33 TI M10
Part No.	745 201	745 202
Size	E27	E33
Contact pin	Brass/gal CuSn	Brass/gal CuSn
Thread	Plastic	Plastic
Max. cable cross-section	25 mm <sup>2</sup>	25 mm <sup>2</sup>
Max. short-circuit current $I_k$ 0.5 s	7.0 kA	7.0 kA
Max. short-circuit current $I_k$ 1 s	4.9 kA	4.9 kA



#### Screw-in Earthing Insert with M10 Connection

Conductive thread

To be screwed into E27 and E33 threaded fuse holders using TI earthing handle

Type	ESE E27 KBI M10	ESE E33 KBI M10
Part No.	745 203	745 204
Size	E27	E33
Contact pin	Plastic	Plastic
Thread	Brass/gal CuSn	Brass/gal CuSn
Max. cable cross-section	25 mm <sup>2</sup>	25 mm <sup>2</sup>
Max. short-circuit current $I_k$ 0.5 s	7.0 kA	7.0 kA
Max. short-circuit current $I_k$ 1 s	4.9 kA	4.9 kA



#### Earth Clamp with flexible adjustable Handle and two Setting Positions

To be connected to the earth cable end of earthing and short-circuiting devices for cable distribution cabinets, with M8 terminal stud, protection against twisting and nut

Type	EK I FL20 DGF
Part No.	745 602
Clamping range	Up to 20 mm



#### Bare Earth Clamp with Wing Bolt

To be connected to the earth cable end of earthing and short-circuiting devices for cable distribution cabinets, with M8 bolt, protection against twisting and nut

Type	EK FL20 FS
Part No.	745 502
Clamping range	Up to 20 mm



#### TI Earthing Handle

With dual function

- For installing earthing cartridges or screw-in earthing inserts with M10 terminal
- For connecting TI earthing and short-circuiting devices to earthing cartridges (socket wrench insert size 19)

Type	EG TI EKV
Part No.	745 400
Length	355 mm



#### Adjustable Handle with flexible Shaft

With magnetic socket wrench insert

For connecting spring-loaded earth clamps

Type	DGF EKV VI
Part No.	745 921
Length	290 mm



#### Plastic Case, empty

With foam padding and hook-and-loop fastener

Type	KK 56 41 17 EK VI TI
Part No.	745 952
Dimensions	565 x 410 x 170 mm



Safety Equipment

Three-pole Earthing and Short-Circuiting Devices

Equipment for Voltages up to 1000 V

- For insulated or uninsulated conductor bars of cranes and lifting equipment
- Allows to lock the clamping range of the clamps in several positions
- Waterproof, plastic-sheathed cable entries and node unit, with additional protection against twisting
- Other cable lengths can be selected online via the earthing and short-circuiting configurator

EaS Configurator:  
[www.dehn.de/en/euk](http://www.dehn.de/en/euk)

With clamps for crane conductor bars

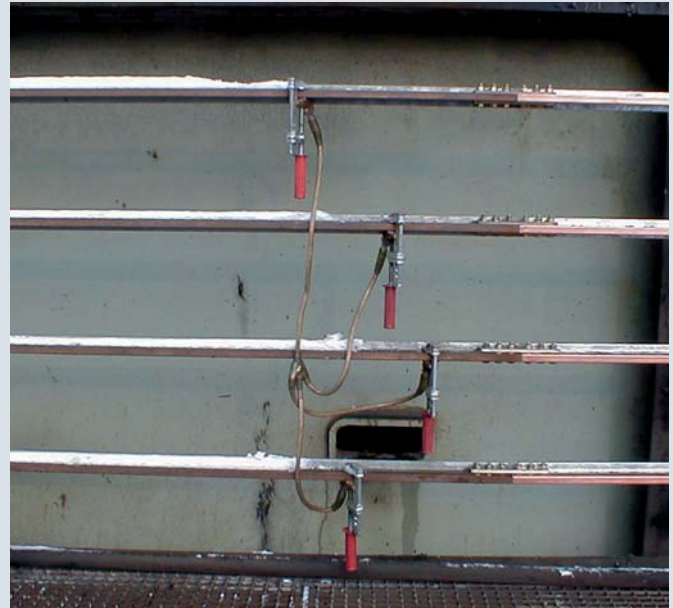

Three-pole earthing and short-circuiting device with clamps

General Information:

Standard	EN/IEC 61230 (DIN VDE 0683 Part 100)
Temperature range	- 25 °C ... + 55 °C
Material (clamp body)	MCl/gal Zn
Material (pressure plates)	Copper alloy
Material (short-circuiting cables)	Highly flexible copper

With Clamps for insulated Conductor Bars

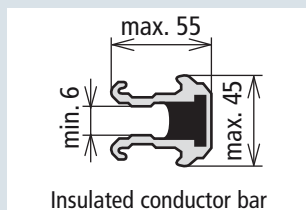
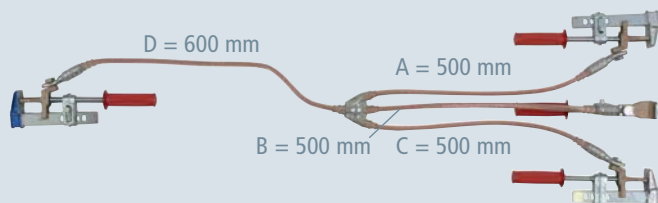

With Clamps for uninsulated Conductor Bars

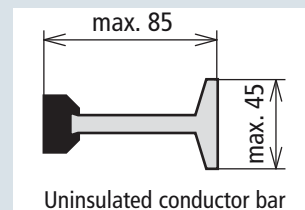
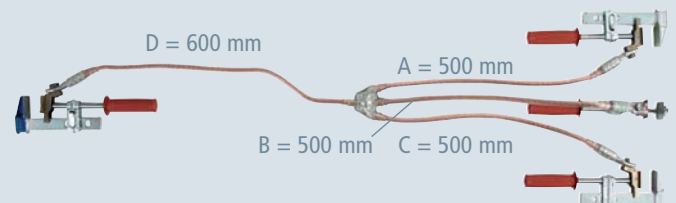

Type	EKV3 25IS ZK	EKV3 35IS ZK	EKV3 50IS ZK
Part No.	745 370	745 371	745 372
Variant number	VH8QTCZ	VKB2Q6J	VP6YV4T
Clamping range	55 mm	55 mm	55 mm
Cable cross-section	25/25 mm <sup>2</sup>	35/35 mm <sup>2</sup>	50/50 mm <sup>2</sup>
Max. short-circuit current I <sub>k</sub> 0.5 s	7.0 kA	10.0 kA	14.0 kA
Max. short-circuit current I <sub>k</sub> 1 s	4.9 kA	6.9 kA	9.9 kA

Note: When ordering please specify the Variant No.

Type	EKV3 25BS ZK	EKV3 35BS ZK
Part No.	745 375	745 376
Variant number	VQTK4T	VN63A91
Clamping range	85 mm	85 mm
Cable cross-section	25/25 mm <sup>2</sup>	35/35 mm <sup>2</sup>
Max. short-circuit current I <sub>k</sub> 0.5 s	7.0 kA	10.0 kA
Max. short-circuit current I <sub>k</sub> 1 s	4.9 kA	6.9 kA

Note: When ordering please specify the Variant No.

The clamp for the PEN conductor is marked in blue.

## Four-pole to six-pole Earthing and Short-Circuiting Devices

Safety Equipment

For low-voltage overhead conductors up to  $\varnothing 12$  mm (95 mm<sup>2</sup>)

Equipment for Voltages up to 1000 V



Sample construction of a four-pole short-circuiting device

- Insulated screw clamps for overhead conductors
- Four-pole version, extendible up to six poles
- Reliable conductivity due to copper bar in the insulating tube

The devices have an insulated threaded stick (with handle) for safe contact with the overhead lines and for fast installation (reliable contact due to spring-loaded screw clamp) at the overhead conductors. The fully insulated device is available as four-pole (with fixed node unit), five-pole or six-pole version (with extendible node unit).

### General Information:

Standard	EN/IEC 61230 (DIN VDE 0683 Part 100)
Temperature range	- 25 °C ... + 55 °C
Material (insulating tube)	Glass-fibre reinforced polyester tube
Length (insulating tube)	2x 300 mm, 2x 800 mm
Material (clamp body)	Copper alloy, insulated
Material (short-circuiting cables)	Highly flexible copper
Length (short-circuiting cables)	600 mm

### Four-pole Node Unit

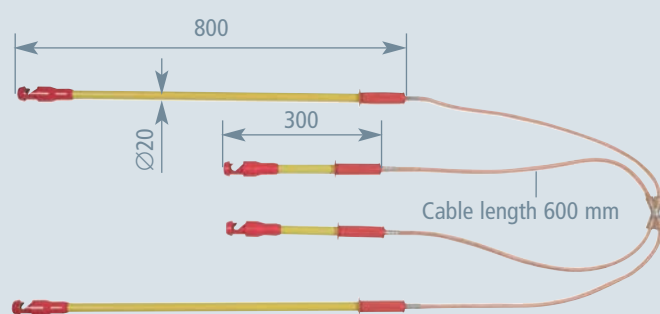

Type	KV4 25 NSFL ISK95
Part No.	742 225
Cable cross-section	25 mm <sup>2</sup>
Max. short-circuit current $I_k$ 0.5 s	7.0 kA
Max. short-circuit current $I_k$ 1 s	4.9 kA

### Four-pole Node Unit, extendible up to five to six-pole

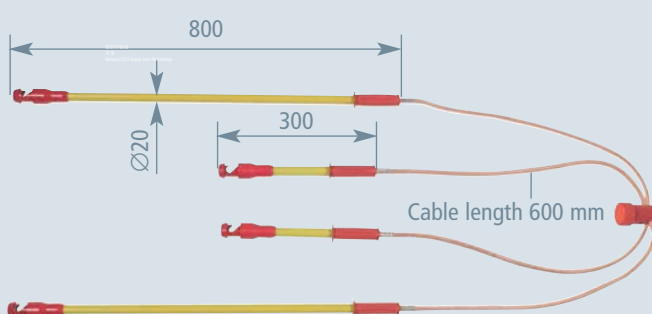

Type	KV4 25 NSFL ISK95 E
Part No.	742 425
Cable cross-section	25 mm <sup>2</sup>
Max. short-circuit current $I_k$ 0.5 s	7.0 kA
Max. short-circuit current $I_k$ 1 s	4.9 kA

### Additional single-pole Conductors

Type	ZA 25 ISK95 300	ZA 25 ISK95 800
Part No.	740 300	740 800
Cable cross-section	25 mm <sup>2</sup>	25 mm <sup>2</sup>
Length( insulating tube)	300 mm	800 mm
Max. short-circuit current $I_k$ 0.5 s	7.0 kA	7.0 kA
Max. short-circuit current $I_k$ 1 s	4.9 kA	4.9 kA

Other cable or insulating tube length are available on request.

Safety Equipment

**Three-pole Earthing and Short-Circuiting Kit for Street Lighting Systems**

Equipment for Voltages up to 1000 V

- For junction and fuse boxes of street lighting systems
- For E14 fuse links
- E27 to E14 aluminium adapter
- Max. backup fuse 32 A power circuit breaker (B characteristic)



Type	EKV ÜGK MB S
Part No.	745 105
Dimensions	395 x 295 x 105 mm



Earthing and short-circuiting device installed at a junction and fuse box of a street lighting mast

**Accessory for Earthing and Short-Circuiting Kit**

**E27 / E14 Adapter**

Reducing insert for converting from E27 to E14 threads  
Allows to use earthing and short-circuiting devices with E14 screw-in earthing inserts even for E27 threads

Type	RED E27 E14 ÜGK MB
Part No.	745 108
Dimensions	∅30 x 25 mm
Material	Aluminium



**Installation Adapter**

For installing E27 / E14 adapters and gauge rings for D-fuses DII and DIII

Type	PSS DII
Part No.	745 109
Dimensions	∅30 x 110 mm
Material	Plastic



**Adjustable Handle with flexible Shaft**

With magnetic socket wrench insert  
For connecting spring-loaded earth clamps

Type	DGF EKV VI
Part No.	745 921
Length	290 mm



**Accessory for Earthing and Short-Circuiting Kit**

**Plastic Case, empty**

With foam padding

Type	KKL EKV ÜGK MB
Part No.	745 106
Dimensions	395 x 295 x 105 mm



**Earthing and Short-Circuiting device for Street Lighting Systems**

With 3 fixed E14 screw-in earthing inserts and spring-loaded earth clamp, clamping range up to 24 mm (fixation using an adjustable handle, Part No. 745 921)

Type	EKV ÜGK MB
Part No.	745 107
Cable cross-section	6 mm <sup>2</sup>

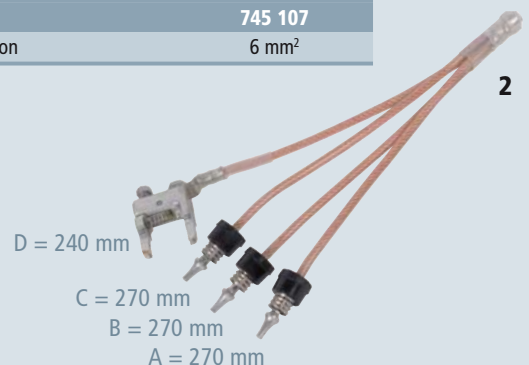



## Earthing Handle

Safety Equipment

### For low-voltage installations

Equipment for Voltages up to 1000 V



Applying an earthing and short-circuiting device in a low-voltage switchgear installation using an earthing handle

- For applying earthing and short-circuiting devices in low-voltage installations
- End fitting with plug-in coupling for handle extension
- Light-weight construction
- Hexagon shaft (width across flats 19) or T pin shaft

#### General Information:

Standard	T pin shaft DIN 48087
Temperature range	- 25 °C ... + 55 °C
Material (insulating tube)	Glass-fibre reinforced polyester tube
Material (coupling)	Plastic
Material (end fitting)	Plug-in coupling for extending the handle

### Earthing Handle, STK hexagon shaft

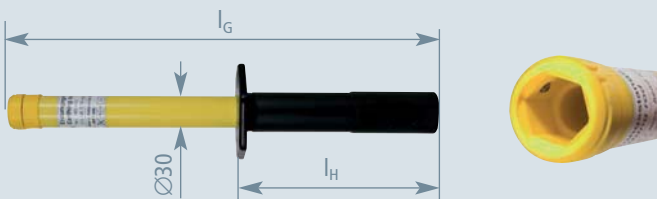

Spring locking mechanism and plug-in coupling for extending the handle

Type	EG SK STK 400
Part No.	745 415
Total length ( $l_G$ )	400 mm
Length (handle) ( $l_H$ )	185 mm

### Earthing Handle, STK T Pin shaft

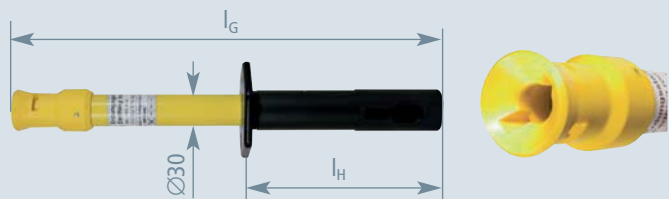

Bayonet locking mechanism and plug-in coupling for extending the handle

Type	EG SQ STK 400
Part No.	745 414
Total length ( $l_G$ )	400 mm
Length (handle) ( $l_H$ )	185 mm



## Safety Equipment

## Equipment for Voltages up to 1000 V

- Extremely shock-resistant, waterproof and dust-proof enclosure
- Sensor with easily identifiable switching point
- Two versions with different measuring ranges
- For use in overhead line networks by attaching extension prods
- No batteries required
- Safe two-hand operation
- CAT IV offers maximum safety against impulse voltage



Each handle of the voltage detector is fitted with a test button. These buttons activate the measuring element and LED display. High-resistance tests (LCD) can be performed without pressing the buttons and low-resistance tests by pressing the buttons.

## Accessory for Two-pole SPN Voltage Detector

## Extension Prod

For use in overhead line networks, to be screwed onto the basic device

Type	VS 500 SPN II
Part No.	766 542
Length	500 mm



## Storage Bag, empty

For SPN voltage detectors (basic device with extension prods)

Type	AT SPN II
Part No.	766 543
Material	Artificial leather



## Two-pole SPN Voltage Detector

Nominal voltages up to 1000 V



Two-pole SPN voltage detector used with extension prods for overhead lines

## General Information:

Standard	EN/IEC 61243-3 (DIN VDE 0682 Part 401)
Temperature range	-10 °C ... +55 °C
Degree of protection	IP 65
Use	Suitable for use in wet weather conditions
Material (indicator)	Safety enclosure made of solid rubber
Indication	Moving-iron instrument, LCD and LED
Connecting cable	Rubber-sheathed cable, highly flexible, 1000 mm
Overvoltage category	CAT IV in accordance with IEC 60664-1



Basic devices

Type	SPN 500	SPN 1000
Part No.	766 541	766 545
Nominal voltage range $U_N$	100 ... 500 V	120 ... 1000 V
Frequency range	0 ... 100 Hz	0 ... 100 Hz
Dimensions (indicator)	274 x 75 x 47 mm	274 x 75 x 47 mm

Other versions are available on request.



Safety Equipment

Single-pole Earthing and Discharge Devices

Further Equipment

- For discharging static charges
- Different contact electrodes
- Coupling electrode, especially for round conductors (Ø12 ... 26.5 mm) of electrostatic precipitator systems
- Waterproof, plastic-sheathed cable entries, additionally protected against twisting



General Information:

Use	Not suitable for use in wet weather conditions
Material (contact electrode)	Copper alloy/gal Sn
Material (contact and coupling electrode)	Zamak
Material (coupling electrode)	Bronze/gal Sn
Material (insulating tube)	Glass-fibre reinforced polyester tube
Material (earthing cable)	Highly flexible copper

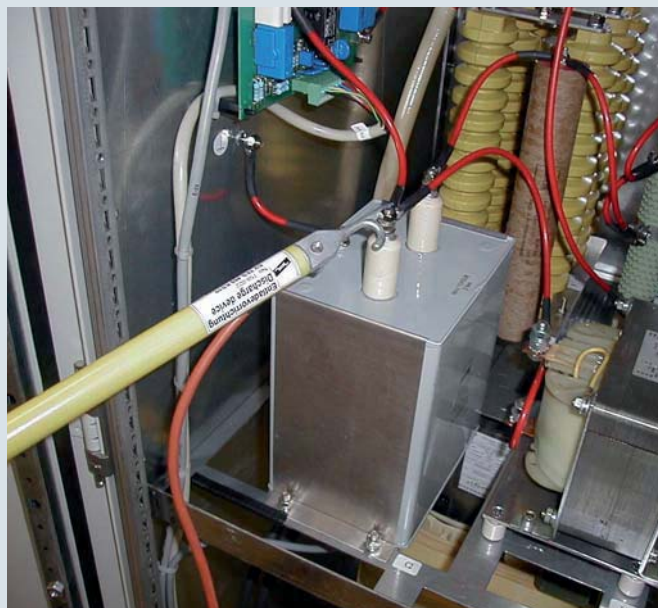

Single-pole device for discharging static charges

with Handle and Earth Clamp with Wing Bolt

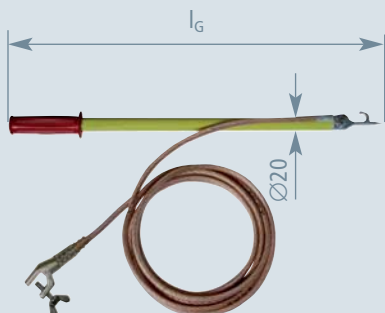

Type	EV TES 465 EK
Part No.	758 020
Cable length	3500 mm
Cable cross-section	16 mm <sup>2</sup>
Cable sheath	Transparent
Total length (l <sub>G</sub> )	550 mm
Clamping range	Up to 20 mm

with Handle and Spring-loaded Earth Clamp

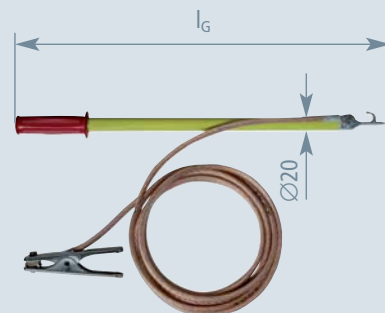

Type	EV TES 465 EZ
Part No.	758 021
Cable length	3500 mm
Cable cross-section	16 mm <sup>2</sup>
Cable sheath	Transparent
Total length (l <sub>G</sub> )	550 mm
Clamping range	Up to 18 mm

with Handle and Earth Cable Lug

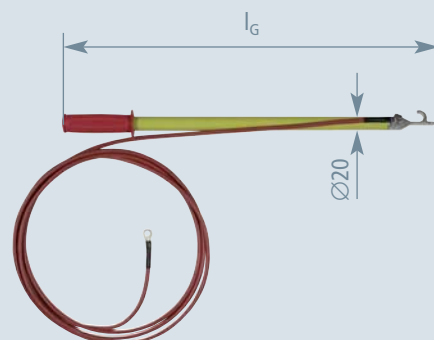

Type	EV TES 465 KS10
Part No.	758 022
Cable length	3500 mm
Cable cross-section	10 mm <sup>2</sup>
Cable sheath	Red silicone cable
Total length (l <sub>G</sub> )	550 mm

Hole (Ø8.4 mm) and silicone conductor

## Single-pole Earthing and Discharge Devices

Safety Equipment

## with Earth Clamp with Wing Bolt

Further Equipment

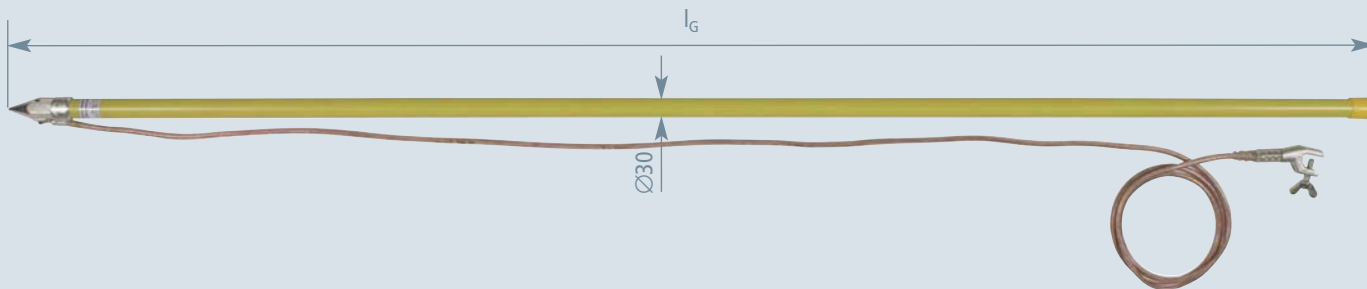

Type	EV TS 2000 EK
Part No.	758 001
Cable length	3500 mm
Cable cross-section	16 mm <sup>2</sup>
Cable sheath	Transparent
Total length (l <sub>G</sub> )	2050 mm
Clamping range	Up to 20 mm

## with Spring-loaded Earth Clamp

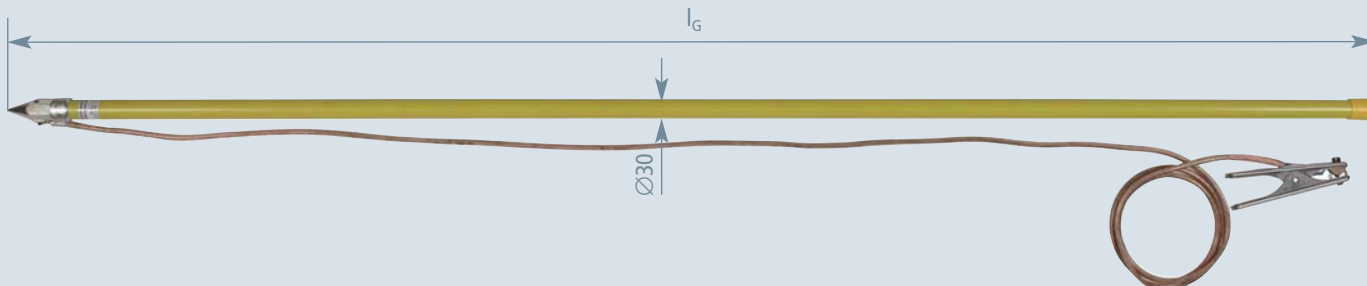

Type	EV TS 2000 EZ
Part No.	758 003
Cable length	3500 mm
Cable cross-section	16 mm <sup>2</sup>
Cable sheath	Transparent
Total length (l <sub>G</sub> )	2050 mm
Clamping range	Up to 18 mm

## with Earth Clamp with Tommy Bar

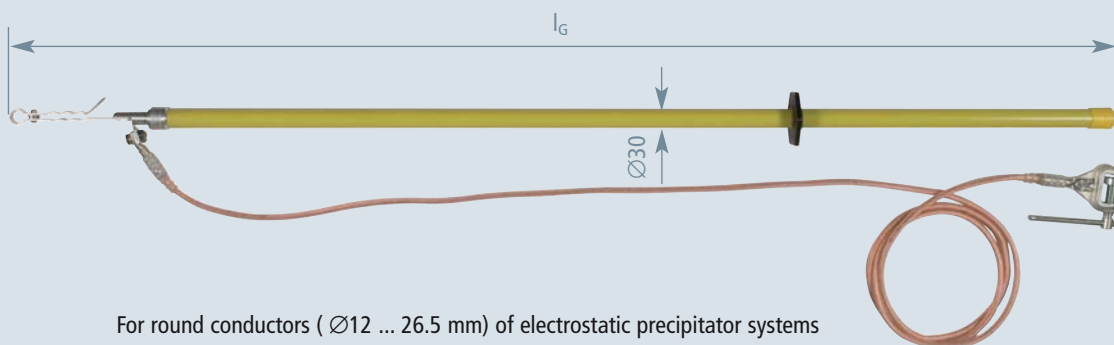

Type	EV EH 1725 EK
Part No.	758 015
Cable length	3500 mm
Cable cross-section	25 mm <sup>2</sup>
Cable sheath	Transparent
Total length (l <sub>G</sub> )	1725 mm
Clamping range	Up to 30 mm

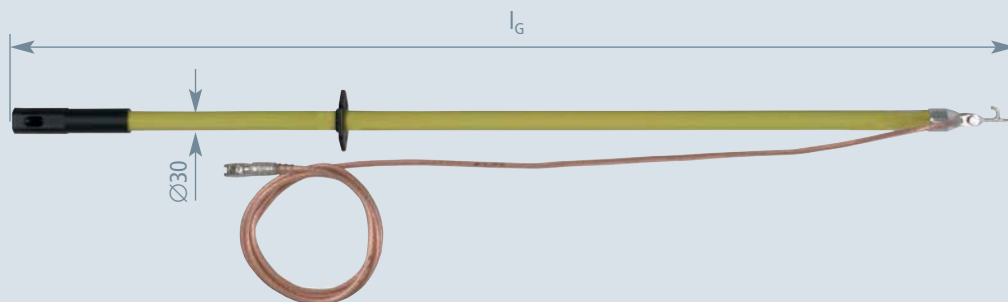
PK1 Crimped cable lug (hole  $\varnothing 12.5$  mm, protected against twisting).

Type	EV TES STK 1500 KS
Part No.	758 025
Cable length	3500 mm
Cable cross-section	16 mm <sup>2</sup>
Cable sheath	Transparent
Total length ( $l_G$ )	1500 mm





## Live Working

Permanent availability of electricity has become a decisive factor in international competition. At the same time, power interruptions must be reduced as a result of the increasing cost pressure. This makes it difficult to ensure reliability of existing installations and to perform maintenance work as entire parts of the installation cannot be isolated and the only alternative is live working. DEHN + SÖHNE has long-standing experience in the field of live working and has developed products which can be found in the DELTEC product range.

### Isolating installations for maintenance work

Electrical equipment and low-voltage, medium-voltage and high-voltage systems such as overhead lines, transformer substations, switchgear installations, distribution boards, transformer cells or cable distribution cabinets cannot be isolated or can only be isolated with great effort due to undesired downtimes and costly work on Sundays and public holidays.

### Live cleaning

#### Clean installations increase system reliability

Soiled electrical installations and adverse weather conditions (moisture) may cause power failure, damage to the equipment and even personal injuries as a result of an electrical arc. In medium-voltage installations, dust layers and residues from lubricants on insulators and cable sealing ends may cause failure. In cable distribution boards and low-voltage installations, cobwebs, weeds and dust are likely to occur.

#### Regular cleaning intervals

Surveys revealed that open indoor installations and cable distribution cabinets have to be cleaned at regular intervals between 6 months and 2 years depending on the type and degree of pollution.

#### Dry suction cleaning combined with damp cleaning

Dry cleaning work is performed by suction cleaning with operating heads or brushing soiled parts of the installation while simultaneously sucking the dirt away. Loose layers of dust and cobwebs are easily cleaned with little effort. Damp cleaning eliminates oily and tough pollutant layers with the help of sponges soaked with special insulating cleaning liquid. This type of work is performed according to "hot stick working" procedure.

#### Dry suction cleaning equipment

Suction cleaning equipment consists of a cleaning head (operating heads, brushes), intake tube with handle, extension, intake hose and suction device.

All single parts are made of plastic and are fully insulated. The shape of the brushes and operating heads is largely adapted to the parts of installations to be cleaned.

The special plug-in coupling system of the dry cleaning equipment prevents accidental use of accessories not intended for this application (e.g. accessories of industrial vacuum cleaners).

### Requirements on the vacuum cleaner

The vacuum cleaner used must meet the following requirements:

- The industrial vacuum cleaner must have a minimum air velocity of 20 m/s and a visual indication of the intake capacity.
- The intake hose must have a continuous inner diameter  $\geq \varnothing 30$  mm and must not contain any metal parts.

### Damp cleaning equipment

Damp cleaning equipment consists of special cleaning heads (sponge holders), an insulating stick with handle and extension elements. All single parts are fully insulated. The plug-in system of operating heads and sponges allows easy and fast replacement of dirty sponges. Only approved sponges may be used for this purpose.

### Refilling cable sealing ends

#### Refilling insulating oil into cable sealing ends

The refilling device considerably reduces the refilling procedure, making it safer and easier. The insulating oil is heated according to the manufacturers' specifications and filled into the cable sealing end by simply pushing a button on the refilling lance. The compact device with rolls has a max. capacity of 5 litres of insulating oil. The screw plug at the cable sealing end is loosened with an insulated screw driver (insulating operating stick with interchangeable operating head). This type of work is performed according to "hot stick working" procedure.

#### Equipment for refilling insulating oil into cable sealing ends

Refilling equipment consists of a pumping unit with a reservoir, regulated heating, pump, refilling lance and an insulated screw driver system consisting of an insulating stick with a manually operated mechanism (adjustable handle) and interchangeable operating heads (straight and angled) with a safety plug-in system accepting different bits and screw plugs. The refilling lance and the pumping unit are connected via a hose and a control line (pump ON/OFF). The refilling lance and the screw driver are fully insulated. Special plastic screw plugs are available for different cable sealing ends which are attached to the insulated screw driver.

### Requirements on installers

#### Selection of electrically skilled persons for live working

Only electrically skilled persons with experience of several years in the operation and maintenance of electrical installations are allowed to perform maintenance and repair work. Electrically skilled persons must be theoretically and practically trained for this type of work.

#### Training as live worker

The training for specialised live workers is based on detailed target descriptions as required by the German professional association for precision and electrical engineering. It includes theoretical and practical training and a "live working" certificate upon completion of the training.

## Live Working Product Range

## Live Working

### Live Working

#### "Live working" procedure

During hot stick working, the worker keeps a predefined distance from live parts of the installation and uses insulating sticks/operating sticks.

#### Design of operating sticks

Operating sticks according to DIN VDE 0681/0682 are hand-held devices for operating, testing and shielding live equipment. They consist of one or several insulating sticks rated for the nominal voltage of the equipment and of an operating head designed for the intended application. **Operating sticks**, are for example **intake tubes**, **insulating sticks**, **locking sticks**, **refilling lances** or **insulated screw drivers**. They are marked with a **triangle symbol**  on the rating plate.

An operating stick consists of a **handle**, an **insulating element** and an **operating head**.

The **operating head** is the part of the operating stick containing the operating element, for example cleaning heads and brushes of a dry cleaning kit or the sponge holders of a damp cleaning kit.

The **insulating element** is the part of the operating stick between the hand guard and red ring. It provides the user with a safety distance and sufficient isolation for safe operation.

The **extension** is the part of the operating stick between the insulating and operating element of the operating head. It allows the user to reach remote parts of the installation and to pass the operating head next to live parts.

The **hand guard** provides a visible barrier between the handle and the insulating element and prevents the user from making contact with the insulating element.

The **red ring** indicates the end of the insulating element in the direction of the operating head. It provides a visible barrier and prevents the user from making contact with live parts of the installation. The insulating element between the red ring and hand guard must not contact live parts, however, contact with earthed parts is allowed.

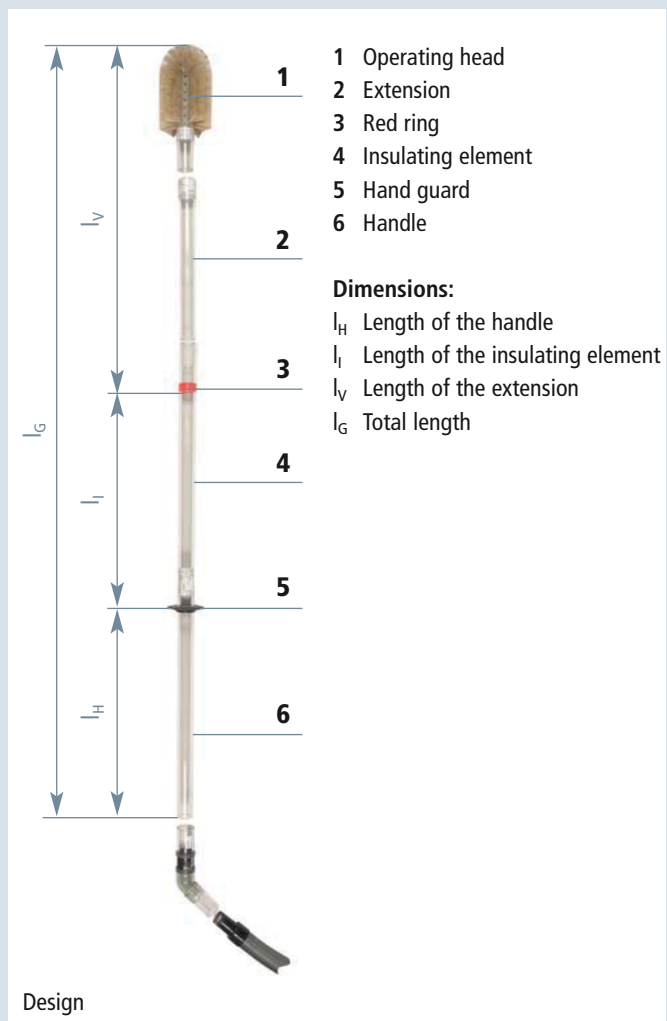

## Live Working

## Selection Guide

## Live Working Product Range

Devices	Nominal voltage $U_N$ / Frequency $f_N$	Application	Page	
TRS NS Dry Cleaning Kit	up to 1000 V / 15 ... 60 Hz	Live cleaning by suction Specially adapted operating heads for intensive cleaning Plug-in coupling system allows fast replacement of operating heads	132	
TRS MS TRS MS V1 Dry Cleaning Kit	up to 36 kV / 15 ... 60 Hz	Live cleaning by suction Transparent intake tubes for enhanced safety Specially adapted operating heads for intensive cleaning Plug-in coupling system allows fast replacement of operating heads	135	
FRS ZK MS Damp Cleaning Kit	up to 36 kV / 15 ... 60 Hz	Damp cleaning element for use under live conditions with special cleaning liquid Universal gear coupling for replacing and adjusting the angle of operating heads Plug-in operating heads allows fast and easy replacement of sponges	137	
TFRS MS Combined Cleaning Kit	up to 36 kV / 15 ... 60 Hz	Combined equipment for dry and damp cleaning Transparent intake tubes for enhanced safety Specially adapted operating heads for intensive cleaning Universal gear coupling for replacing and adjusting the angle of operating heads Plug-in operating heads allows fast and easy replacement of sponges	138	
NFG MS Refilling Device	up to 36 kV / 15 ... 60 Hz	Refilling of insulating oil under live conditions Safe, fast and easy refilling procedure	144	
MS Insulated Screw Driver	up to 36 kV / 15 ... 60 Hz	For loosening and tightening the screw plugs of cable sealing ends under live conditions With interchangeable operating heads	146	

## Maintenance tests

According to German regulations (BGV A3), operating sticks have to be tested for compliance with the prescribed limits as stated in the Electrical Safety Rules. This test includes:

- measurement of the leakage current,
- test for protection against bridging,
- visual inspection

This maintenance test is documented in a test report and on the device.

The test intervals depend on the operating conditions of the operating stick e.g. frequency of use, environmental conditions and transport. According to German regulations, however, it is advisable to carry out a maintenance test **at least every 6 years**.



## TRS NS Dry Cleaning Kit

Live Working

Nominal voltages up to 1000 V / 15 ... 60 Hz

Cleaning Equipment



Live cleaning of a low-voltage switchgear installation using the TRS NS dry cleaning kit

- For indoor and outdoor installations
- Equipment for suction cleaning under live conditions
- For dry cleaning of cable distribution cabinets, open indoor installations and control cabinets
- Specially adapted operating heads for intensive cleaning
- Plug-in coupling system allows fast replacement of operating heads
- Regulation of intake air in the handle area



### General Information:

Standard	Based on DIN VDE 0680 Part 3
Use	Not suitable for use in wet weather conditions

### Requirements

Cleaning work up to 1000 V must be carried out under supervision of a qualified electrician according to EN 50110-1 "Operation of electrical installations – Minimum Requirements". In Germany TRS NS dry cleaning kits are subject to BGV A3 of the national accident prevention regulations (UVV) "Elektrische Anlagen und Betriebsmittel" [Electrical installations and equipment] stipulated by the German Employer's Liability Association for the energy, textile, electrical and media product sector (BGEM).



Chamfered flat cleaning head in use



Tubular brush in use

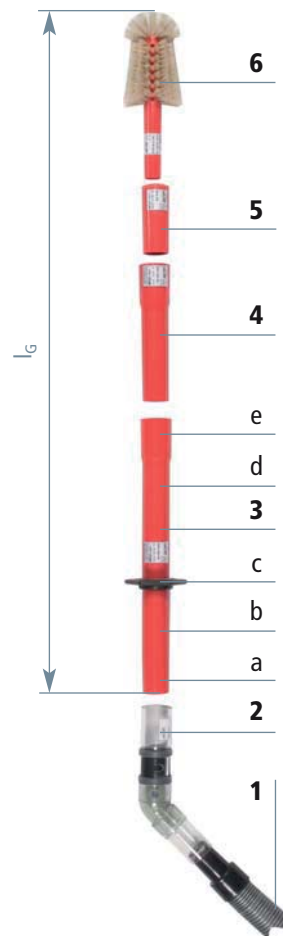

- 1 Intake hose
- 2 Intake hose adapter
- 3 Intake tube with
  - a Lower connecting part
  - b Handle
  - c Hand guard
  - d Insulating element
  - e Top connecting part
- 4 Extension tube
- 5 Intake tube adapter
- 6 Cleaning head

### Dimensions:

$l_{G \min} = 560 \text{ mm}$   
 $l_{G \max} = 1350 \text{ mm}$

Design



## Live Working

## TRS NS Dry Cleaning Kit

## Cleaning Equipment

Fully equipped plastic case



Type	TRS NS
Part No.	785 502
Dimensions	530 x 390 x 170 mm

## Single Parts for TRS NS Dry Cleaning Kit

## Plastic Case, empty

With retaining clips

Type	KKL TRS NS
Part No.	785 506
Colour	Black
Dimensions	530 x 390 x 170 mm



## Extension

Insulating tube, with top and lower connecting part

Type	SRV 200 NS	SRV 300 NS	SRV 400 NS
Part No.	785 521	785 522	785 523
Diameter	40 mm	40 mm	40 mm
Dimensions	200 mm	300 mm	400 mm



## Single Parts for TRS NS Dry Cleaning Kit

## Intake Tube with Handle

For use as operating tube with handle and hand guard, with top and lower connecting part

Type	SRH 400 NS
Part No.	785 520
Dimensions	380 mm



## Adjustable Angle

Lockable, adjustable due to 15° gearing, with top and lower connecting part

Type	SRW V NS
Part No.	785 530
Diameter	40 mm
Dimensions	300 mm



## Flat Cleaning Head 55

Width: 55 mm

Type	FD 55 NS
Part No.	785 540
Diameter	40 mm
Dimensions	200 mm



## Flat Cleaning Head 35

Width: 35 mm

Type	FD 35 NS
Part No.	785 541
Diameter	25 mm
Dimensions	200 mm



## Flat Cleaning Head 35

Width: 35 mm, 60° outlet, chamfered

Type	FD 35 S NS
Part No.	785 542
Diameter	25 mm
Dimensions	200 mm



## Flat Cleaning Head 35

Width: 35 mm, straight, with detachable brush

Type	FD 35 P NS
Part No.	785 590
Diameter	25 mm
Dimensions	230 mm



## Flat Cleaning Head 35

Width: 35 mm, 30° angled, with detachable brush

Type	FD 35 W P NS
Part No.	785 591
Diameter	25 mm
Dimensions	240 mm



## Round Cleaning Head

With scraper (50 mm)

Type	RD 25 S NS
Part No.	785 560
Diameter	25 mm
Dimensions	240 mm



## TRS NS Dry Cleaning Kit

Live Working

### Single Parts

Cleaning Equipment



#### Cross Cleaning Head 35

Width: 35 mm, 30° angled

Type	QD 35 W NS
Part No.	785 543
Diameter	25 mm
Dimensions	200 mm



#### Round Cleaning Head

With brush

Type	RD 25 P NS
Part No.	785 570
Diameter	25 mm
Dimensions	230 mm



#### Tubular Brush 85 mm

Cylindrical bristles

Type	STB 85 Z NS
Part No.	785 550
Diameter	25 mm
Dimensions	240 mm



#### Tubular Brush 85 mm

Conical bristles

Type	STB 85 K NS
Part No.	785 555
Diameter	25 mm
Dimensions	240 mm



#### Intake Tube Adapter

For brushes and cleaning heads (Ø25 mm)

Type	SRA NS
Part No.	785 515
Diameter	40 / 25 mm
Dimensions	100 mm



#### Intake Hose Adapter

Adjustable, 120° angled, regulation of intake air, for use with intake hose system (Ø35 mm)

Type	SSA W D
Part No.	785 200
Diameter	35 / 40 mm



#### Spare Brush

Short bristles, for flat cleaning heads with detachable brush

Type	EP 25 K NS
Part No.	785 595
Dimensions	25 mm
PU	3 pieces



#### Spare Brush

Long bristles, for flat cleaning heads, with detachable brush

Type	EP 25 L NS
Part No.	785 596
Dimensions	40 mm
PU	3 pieces



#### Cleaning Brush

For individual kit parts (Ø40 mm)

Type	RB 40 NS
Part No.	785 580
Diameter	45 mm
Dimensions	410 mm



#### Cleaning Brush

For individual kit parts (Ø25 mm)

Type	RB 20 NS
Part No.	785 585
Diameter	30 mm
Dimensions	330 mm

## Live Working

### Cleaning Equipment

- For indoor and outdoor installations
- Equipment for live cleaning by means of suction
- For dry cleaning of transformers and switch-gear installations
- Transparent intake tubes ensure enhanced safety
- Specially adapted operating heads for intensive cleaning
- Plug-in coupling system allows fast replacement of operating heads



## TRS MS Dry Cleaning Kit

Nominal voltages up to 36 kV / 15 ... 60 Hz



Live cleaning of a transformer using the TRS MS dry cleaning kit

### General Information:

Standard	DIN VDE 0682 Part 621
Use	Not suitable for use in wet weather conditions

### Requirements

Cleaning work from 1 to 36 kV must be carried out under supervision of a qualified electrician according to EN 50110-1 "Operation of electrical installations – Minimum Requirements", observing clauses 6.3.1 to 6.3.12. In Germany TRS MS dry cleaning kits are subject to BGV A3 and BGR A3 of the national accident prevention regulations (UVV) "Elektrische Anlagen und Betriebsmittel" [Electrical installations and equipment] stipulated by the German Employer's Liability Association for the energy, textile, electrical and media product sector (BGETEM).

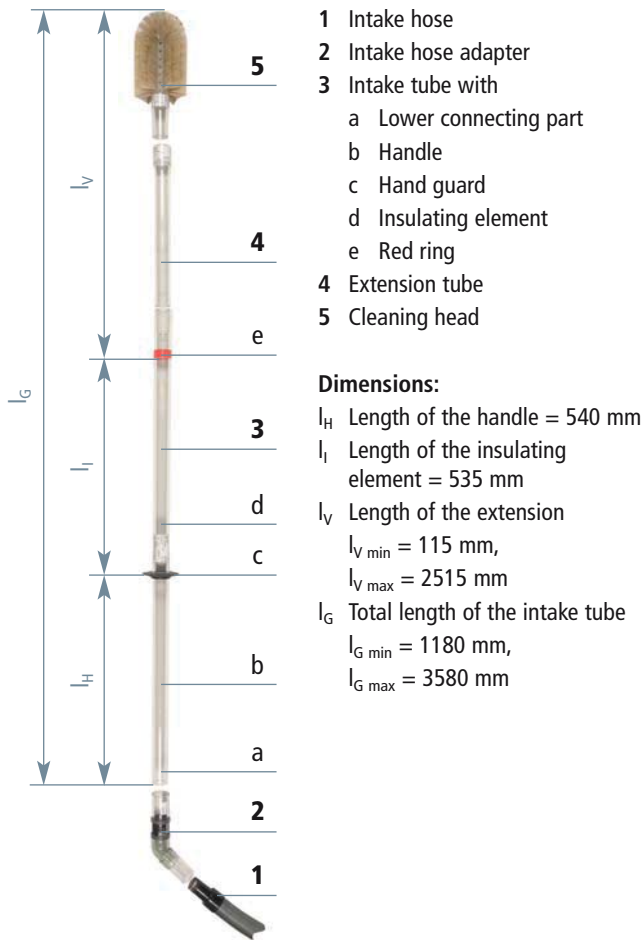

Design



Cleaning an insulator with a flat cleaning head and 135° angled intake tube

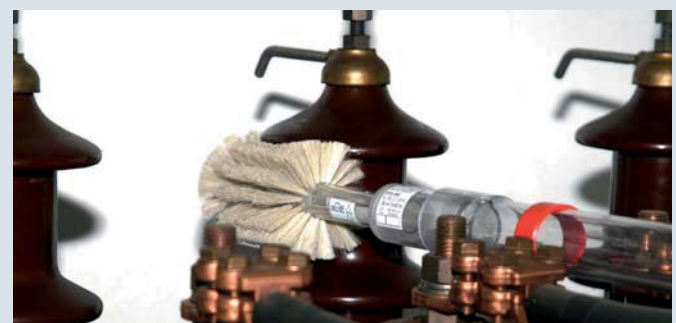

Cleaning an insulator with a tubular brush

## TRS MS Dry Cleaning Kit

Live Working

### TRS MS Dry Cleaning Kit

Cleaning Equipment



Fully equipped GRP case

Type	TRS MS
Part No.	785 100
Dimensions	1200 x 270 x 165 mm

## TRS MS V1 Dry Cleaning Kit



Fully equipped GRP case

Type	TRS MS V1
Part No.	785 112
Dimensions	1200 x 270 x 165 mm



## Live Working

### Cleaning Equipment

- For indoor and outdoor installations
- Damp cleaning equipment for use under live conditions with special cleaning liquid
- Universal gear coupling for replacing and adjusting the angle of operating heads
- Rigid and flexible plug-in operating heads allow fast and easy replacement of the sponges



### Application

Damp sponges allow to remove tough pollution layers and to clean oily transformer surfaces. Special insulating cleaning liquids (e.g. Rivolta SLX 500; SLX TOP or SLX Super from Bremer & Leguil, Duisburg/Germany, and Florin 2000 from Flore, Koblenz/Germany) must be selected according to the rated voltage of the installation and the environmental conditions.

### Requirements

Cleaning work from 1 to 36 kV must be carried out under supervision of a qualified electrician according to EN 50110-1 "Operation of electrical installations – Minimum Requirements", observing clauses 6.3.1 to 6.3.12. In Germany FRS ZK MS damp cleaning kits are subject to BGV A3 and BGR A3 of the national accident prevention regulations (UVV) "Elektrische Anlagen und Betriebsmittel" [Electrical installations and equipment] stipulated by the German Employer's Liability Association for the energy, textile, electrical and media product sector (BGEM).

## FRS ZK MS Damp Cleaning Kit

Nominal voltages up to 36 kV / 15 ... 60 Hz



Damp cleaning of a transformer using the FRS ZK MS damp cleaning kit

### General Information:

Standard	Based on DIN VDE 0681 Part 1 and DIN VDE 0682 Part 621
Standard (universal gear coupling)	EN/IEC 60832 (DIN VDE 0682 Part 211)
Use	Not suitable for use in wet weather conditions



The universal gear coupling permits fast replacement of operating heads and extensions

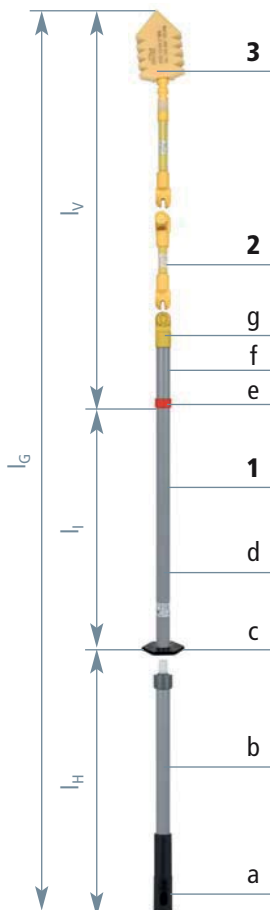

- 1 Insulating stick with
  - a End fitting with plug-in coupling
  - b Handle
  - c Hand guard
  - d Insulating element
  - e Red ring
  - f Extension
  - g Top connecting part
- 2 Extension tube
- 3 Operating head with sponge

### Dimensions:

- $l_H$  Length of the handle = 510 mm  
 $l_I$  Length of the insulating element = 525 mm  
 $l_V$  Length of the extension  
 $l_{V \min}$  = 350 mm,  
 $l_{V \max}$  = 2100 mm  
 $l_G$  Total length  
 $l_{G \min}$  = 1450 mm,  
 $l_{G \max}$  = 3250 mm

Design



Fully equipped GRP case

Type	FRS ZK MS
Part No.	785 940
Dimensions	850 x 300 x 200 mm



## TFRS MS Combined Cleaning Kit

Live Working

Nominal voltages up to 36 kV / 15 ... 60 Hz

Cleaning Equipment



TFRS MS combined cleaning kit used for dry and damp cleaning of a transformer under live conditions

### General Information:

Standard	Based on DIN VDE 0681 Part 1 and DIN VDE 0682 Part 621
Standard (universal gear coupling)	EN/IEC 60832 (DIN VDE 0682 Part 211)
Use	Not suitable for use in wet weather conditions



Fully equipped GRP case and leather bag

Type	TFRS MS
Part No.	785 950
Dimensions (bag)	1400 x 280 mm
Dimensions (case)	850 x 410 x 400 mm

Customised kits are available on request.

- For indoor and outdoor installations
- Combined dry and damp cleaning kit for cleaning under live conditions
- Transparent intake tubes ensure enhanced safety
- Specially adapted operating heads for intensive cleaning
- Universal gear coupling for replacing and adjusting the angle of operating heads
- Rigid and flexible plug-in operating heads allow fast and easy replacement of the sponges



### Application

Dry cleaning work is performed by suction cleaning with operating heads or brushing soiled parts of the installation while simultaneously sucking the dirt away. Loose dust layers and cobwebs are easily removed with little effort. Damp cleaning eliminates oily and tough contaminants with the help of sponges soaked with special insulating cleaning liquids.

### Requirements

Cleaning work from 1 to 36 kV must be carried out under supervision of a qualified electrician according to EN 50110-1 "Operation of electrical installations – Minimum Requirements", observing clauses 6.3.1 to 6.3.12. In Germany TFRS MS combined cleaning kit are subject to BGV A3 and BGR A3 of the national accident prevention regulations (UVV) "Elektrische Anlagen und Betriebsmittel" [Electrical installations and equipment] stipulated by the German Employer's Liability Association for the energy, textile, electrical and media product sector (BGEMEM).



## Live Working

## Single Parts for MS Cleaning Kit

## Cleaning Equipment

## GRP Case, empty

With retaining clips and printed top and bottom insert

Type	KKL TRS MS
Part No.	785 301
Colour	Blue
Dimensions	1200 x 270 x 165 mm



## GRP Case, empty

With retaining clips and printed bottom insert

Type	KKL FRS ZK MS
Part No.	785 229
Colour	Blue
Dimensions	850 x 300 x 200 mm



## GRP Case, empty

With retaining clips and printed top and bottom insert

Type	KKL TFRS MS
Part No.	785 951
Colour	Blue
Dimensions	850 x 410 x 400 mm



## Artificial Leather Bag, empty

With zip and shoulder strap

Type	KLT 140 28
Part No.	785 952
Colour	Black
Dimensions	1400 x 280 mm



## 90° angled Intake Tube

Type	SRW 90 MS
Part No.	785 131
Diameter	40 mm
Dimensions	120 mm



## 135° angled Intake Tube

Type	SRW 135 MS
Part No.	785 132
Diameter	40 mm
Dimensions	100 mm



## Angled Intake Tube

Lockable, adjustable due to 15° gearing, for positioning the cleaning heads

Type	SRW V MS
Part No.	785 130
Diameter	40 mm
Dimensions	160 mm



## Insulating Stick with Handle and plug-in Coupling

For use as operating stick with handle, hand guard, insulating element, red ring and extension, extendible handle

Type	ISH T 1300 ZK MS
Part No.	785 315
Diameter	30 mm
Dimensions	1300 mm



## Intake Tube with Handle

For use as operating tube with handle, hand guard, insulating element, red ring and extension

Type	SRH 1180 MS
Part No.	785 120
Diameter	40 mm
Dimensions	1180, insulating element 525 mm



## Insulating Stick with Handle and plug-in Coupling

Consisting of one element

Type	ISH 1300 ZK MS
Part No.	785 325
Diameter	30 mm
Dimensions	1300 mm



## Extension

Type	ISV 220 ZK MS	ISV 320 ZK MS
Part No.	785 316	785 317
Diameter	20 mm	20 mm
Dimensions	220 mm	320 mm

Type	ISV 420 ZK MS	ISV 820 ZK MS
Part No.	785 318	785 319
Diameter	20 mm	20 mm
Dimensions	420 mm	820 mm



## Extension

Type	SRV 200 MS	SRV 400 MS	SRV 800 MS
Part No.	785 121	785 122	785 123
Diameter	40 mm	40 mm	40 mm
Dimensions	200 mm	400 mm	800 mm



## Single Parts for MS Cleaning Kit

Live Working  
Cleaning Equipment

18



### Rectangular Brush

Type	REB 1095 MS
Part No.	785 160
Diameter	40 mm
Dimensions	105 x 90 x 50 mm

19-20



### Half-round Brush

For cleaning insulators as well as horizontal and vertical openings. The brush can be attached to SRW V MS angled intake tubes that can be adjusted to lead the brush around the complete insulator.

Type	HRB 120 MS	HRB 190 MS
Part No.	785 140	785 150
Diameter	40 / 120 mm	40 / 190 mm

21



### Tubular Brush 120 mm

Cylindrical bristles

Type	STB 120 MS
Part No.	785 170
Diameter	40 mm
Dimensions	250 mm

22



### Tubular Brush 85 mm

Cylindrical bristles

Type	STB 80 MS
Part No.	785 171
Diameter	25 mm
Dimensions	240 mm

23



### Tubular Brush 85 mm

Conical bristles

Type	STB 80 K MS
Part No.	785 172
Diameter	25 mm
Dimensions	240 mm

24



### Round Head Brush

Type	BB 245 MS
Part No.	785 151
Diameter	40 mm
Dimensions	390 mm

25



### Cleaning Head 60

Width: 60 mm

Type	FD 60 MS
Part No.	785 220
Diameter	40 mm
Dimensions	190 mm

26



### Cleaning Head 110

Width: 110 mm

Type	FD 110 MS
Part No.	785 221
Diameter	40 mm
Dimensions	260 mm

27



### Cleaning Head 210

Width: 210 mm

Type	FD 210 MS
Part No.	785 223
Diameter	40 mm
Dimensions	255 mm

28



### Flat Cleaning Head 35

Type	FD 35 S MS
Part No.	785 551
Diameter	40 mm
Dimensions	35 mm

29



### Flat Cleaning Head

Width: 35 mm, 30° angled, with detachable brush

Type	FD 35 W P MS
Part No.	785 552
Diameter	40 mm
Dimensions	35 mm

30



### Scraper

Type	S 30 ZK MS
Part No.	785 320
Diameter	20 mm
Dimensions	280 mm

31



### Round Brush

Type	RP 15 ZK MS
Part No.	785 321
Diameter	20 mm
Dimensions	270 mm

## Live Working

## Single Parts for MS Cleaning Kit

## Cleaning Equipment

## Rigid Operating Head

For attaching cleaning sponges

Type	AK RS S ZK MS
Part No.	785 324
Diameter	20 mm
Dimensions	200 mm



32

## Single Operating Head

Flexible, for attaching cleaning sponges

Type	AK RS ZK MS
Part No.	785 322
Diameter	20 mm
Dimensions	400 mm



33

## Dual Operating Head

Flexible, for attaching cleaning sponges

Type	AK RS 2 ZK MS
Part No.	785 323
Diameter	20 mm
Dimensions	415 mm



34

## Rectangular Cleaning Sponge

Type	RS 1544 MS
Part No.	785 274
Dimensions	150 x 40 x 40 mm
PU	5 pieces



35

## Rectangular Cleaning Sponge

Type	RS 1574 MS
Part No.	785 275
Dimensions	150 x 70 x 40 mm
PU	5 pieces



36

## Rectangular Cleaning Sponge, serrated

Type	RS 15104 Z MS
Part No.	785 279
Dimensions	150 x 100 x 40 mm
PU	5 pieces



37

## Rectangular Cleaning Sponge, serrated

Type	RSD 15104 Z MS
Part No.	785 280
Dimensions	150 x 100 x 40 mm
PU	5 pieces



38

## Intake Hose Adapter

Adjustable, 120° angled, regulation of intake air, for use with intake hose system (Ø35 mm)

Type	SSA W D
Part No.	785 200
Diameter	35 / 40 mm



39

## Intake Tube Adapter

For brushes and cleaning heads (Ø25 mm)

Type	SRA MS
Part No.	785 212
Diameter	40 / 25 mm
Dimensions	100 mm



40

## Operating Head Adapter

Universal gear coupling / transparent tube (Ø25 mm)

Type	AKA TF ZK MS
Part No.	785 259
Diameter	40 mm
Dimensions	125 mm



41

## Single Parts for MS Cleaning Kit

## Live Working

### Cleaning Equipment

#### Digital Hygrometer/Thermometer

For verifying the climatic conditions that must be adhered to.

Measuring range: - 20 °C ... + 70 °C (temperature), 10 ... 95 % (relative air humidity)



42

Type	DHTM
Part No.	785 180
Dimensions	140 x 65 mm

#### Digital Hygrometer/Thermometer

For verifying the climatic conditions that must be adhered to.

Measuring range: 0 °C ... + 50 °C (temperature), 5 ... 95 % (relative air humidity)



43

Type	DHTM T 615
Part No.	785 181
Dimensions	57 x 190 x 42 mm

#### Insulating Mirror

For visual inspection of hidden electrical components



44

Type	ISP 135 MS
Part No.	785 190
Diameter	40 / 135 mm

#### Spray Bottle

For cleaning liquids



45

Type	SF FRF MS
Part No.	785 953
Capacity	500 ml

#### Spare Brush

For FD 39 WP MS flat cleaning heads



46

Type	EP 25 L MS
Part No.	785 224
Dimensions	40 mm
PU	3 pieces

#### Cleaning Brush

For individual kit parts (Ø40 mm), modular



47

Type	RB 50 MS
Part No.	785 210
Diameter	45 mm
Dimensions	1430 mm

#### Cleaning Brush

For individual kit parts (Ø25 mm)



48

Type	RB 20 NS
Part No.	785 585
Diameter	30 mm
Dimensions	330 mm

#### Barrier Rod

Modular, for use as visible working limit

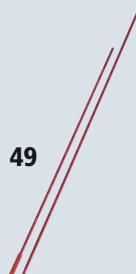

49

Type	AS MS
Part No.	785 109
Dimensions	2200 mm



## Live Working

## Accessory for NS and MS Cleaning Kits

## Cleaning Equipment

## Industrial Vacuum Cleaner

For dry and combined cleaning kits

## Equipment:

The industrial vacuum cleaner consists of a 25 l plastic container, 2 large wheels, 2 guide wheels with locking brakes, handle and cable holder, socket outlet with automatic switch-on mechanism, electromagnetic pulse filter cleaning, automatic vibration function, speed control, volume flow control, acceleration rate controller, electronic running feature, moisture identification with sensor-controlled disconnection, 2 new polyester filter cassettes, FKP 4300, filter area  $2 \times 4300 \text{ cm}^2 = 8600 \text{ cm}^2$ , dust collection capacity in accordance with BIA, class C, cord length: 8 m

## Technical data:

- Intake hose with straight connecting adapter ( $\varnothing 35 \text{ mm}$ ), 5 m long

Type	HIS 1400 TRS
Part No.	785 310
Nominal capacity	1400 W
Nominal voltage	230 V
Max. air flow	61 l/s
Max. low air pressure	248 mbars
Capacity (container)	25 l gross volume, 20 l for dust, 15 l for water
Dimensions	400 x 400 x 560 mm



## Reducing Inserts

For connection between SSA W D intake hose adapter and intake hoses from other manufacturers with different diameters and straight connecting adapter.

Type	RSI 32	RSI 34	RSI 35
Part No.	785 213	785 214	785 215
Diameter	35 / 32 mm	35 / 34 mm	35 / 35 mm
Dimensions	105 mm	105 mm	105 mm

Type	RSI 38	RSI 45
Part No.	785 216	785 217
Diameter	35 / 38 mm	35 / 45 mm
Dimensions	105 mm	105 mm

Type	RSI 51	RSI 58
Part No.	785 218	785 219
Diameter	35 / 51 mm	35 / 58 mm
Dimensions	105 mm	105 mm



## Application:

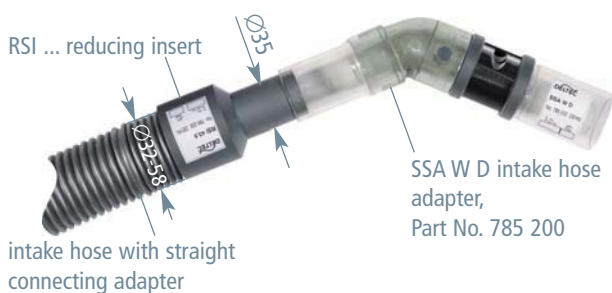

## 90° angled flat Cleaning Head with detachable Brush

For TRS NS dry cleaning kits

Type	FWD 35 P NS
Part No.	785 592
Diameter	25 mm
Dimensions	200 mm



## Intake Tube with Handle

For TRS MS and TFRS MS cleaning kits

Type	SRH 1180 IS 650 MS
Part No.	785 119
Diameter	40 mm
Dimensions	1180 mm, insulating element 650 mm



## HV STK Extension Handle

Plug-in coupling at both ends for extending the handle

Type	HV STK 710
Part No.	766 335
Diameter	30 mm
Total length (l <sub>G</sub> )	710 mm
Material	Glass-fibre reinforced polyester tube
Colour	Grey



## Cover

Type	AP 152 G
Part No.	785 110
Colour	Yellow
Dimensions	1500 x 2000 mm

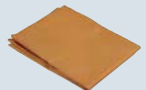

## Canvas Bag, empty

With two separate internal pockets and shoulder strap  
For intake hose, cover, safety helmet with face shield, working gloves

Type	STT 55 27 30
Part No.	785 111
Colour	Olive
Dimensions	550 x 270 x 300 mm



## NFG MS Refilling Device

Live Working

Nominal voltages up to 36 kV / 15 ... 60 Hz

Refilling Equipment



Refilling of hot HT mass under live conditions

- For indoor and outdoor installations
- Equipment for refilling hot HT mass into paper-insulated mass-impregnated cables under live conditions
- Safe, fast and easy refilling procedure
- Transparent insulating refilling lance ensures enhanced safety



### General Information:

Standard	Based on DIN VDE 0681 Part 1 and DIN VDE 0682 Part 621
Design	Not suitable for use in wet weather conditions

### Design

The refilling device consists of a pumping unit with a reservoir, regulated heating and pump as well as an insulating refilling lance. The oil reservoir can be removed for easy transport and can be sealed with a cover. The pump and the insulating refilling lance are connected by means of a temperature-resistant, removable and highly flexible refilling hose and a pump control cable (Ein [On]/Aus [Off] circuit). All components are arranged on a transport vehicle (with additional support brackets), suitable for mounting.

When working under live conditions, the screw plugs of cable sealing ends are removed and replaced with an insulated screw driver. Special plastic screw plugs can be used for sealing the cable ends.

### Requirements

The refilling device is to be used under supervision of a qualified electrician according to EN 50110-1 "Operation of electrical installations – Minimum Requirements", observing clauses 6.3.1 to 6.3.12. In Germany NFG MS refilling devices are subject to BGV A3 and BGR A3 of the national accident prevention regulations (UVV) "Elektrische Anlagen und Betriebsmittel" [Electrical installations and equipment] stipulated by the German Employer's Liability Association for the energy, textile, electrical and media product sectors (BGEMEM).



After lifting the conveying pump out of the HT mass, the oil reservoir can be removed from the NFG MS for refilling.

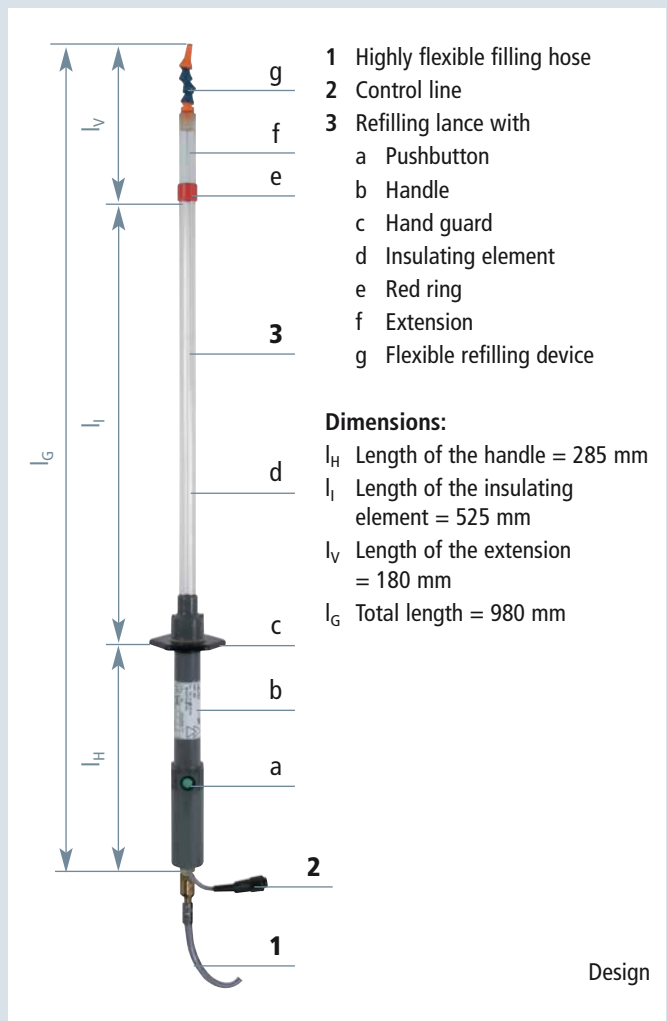

Design

## Live Working

## NFG MS Refilling Device

## Refilling Equipment

## MS Refilling Device

Fully equipped with insulating refilling lance and reservoir

Type	NFG MS
Part No.	785 260
Nominal capacity	1200 W
Supply voltage	230 V
Frequency	50 Hz
Reservoir size	5 litres
Heating control range	0 °C ... + 120 °C
Thermometer indication range	0 °C ... + 120 °C
Dimensions	632 x 329 x 1490 mm



## Accessory for NFG MS Refilling Device

## Insulating Refilling Lance

Operating stick with detachable, highly flexible filling hose (1350 mm), handle, hand guard, insulating element, red ring, extension and flexible lance tip

Type	INFL MS
Part No.	785 261
Diameter	30 / 20 mm
Dimensions	980 mm

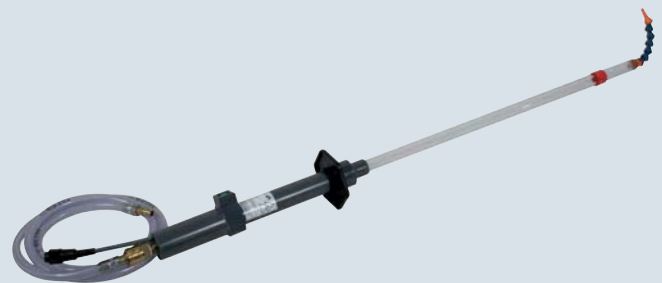

Other lengths of insulating refilling lances are available on request.

## Reservoir

Made of stainless steel, with cover and adjustable ventilation

Type	OEB NFG MS	RFB NFG MS
Part No.	785 264	785 295
Capacity (heating element)	950 W	No heating element
Dimensions	320 x 165 x 164 mm	320 x 165 x 164 mm



## GRP Case, empty

Max. capacity:

3 NFG MS reservoirs

Type	KKL B NFG MS
Part No.	785 299
Colour	Blue
Dimensions	600 x 380 x 220 mm



## MS Screw Driver Set

Live Working

Nominal voltages up to 36 kV / 15 ... 60 Hz

Refilling Equipment



Loosening the locking screw using the MS insulated screw driver

- For indoor and outdoor installations
- For loosening and tightening the screw plugs of cable sealing ends under live conditions
- With interchangeable operating heads (straight and angled)



### General Information:

Standard	Based on DIN VDE 0681 Part 1
Use	Not suitable for use in wet weather conditions

### Application

The insulated screw driver with interchangeable operating heads (straight and angled) for attaching special bits and screw plugs allows to loosen or tighten the screw plugs of cable sealing ends under live conditions. Only tested bits (screw plug blade inserts) and special screw plugs may be used.

### Requirements

Maintenance work from 1 to 36 kV must be carried out under supervision of a qualified electrician according to EN 50110-1 "Operation of electrical installations – Minimum Requirements", observing clauses 6.3.1 to 6.3.12. In Germany MS screw drivers are subject to BGV A3 and BGR A3 of the national accident prevention regulations (UVV) "Elektrische Anlagen und Betriebsmittel" [Electrical installations and equipment] stipulated by the German Employer's Liability Association for the energy, textile, electrical and media product sectors (BGETEM).



Apart from the insulated screw driver kit, the plastic case allows transport of the insulating refilling lance including filling hose and special screw plugs. These elements, however, are not included in delivery.

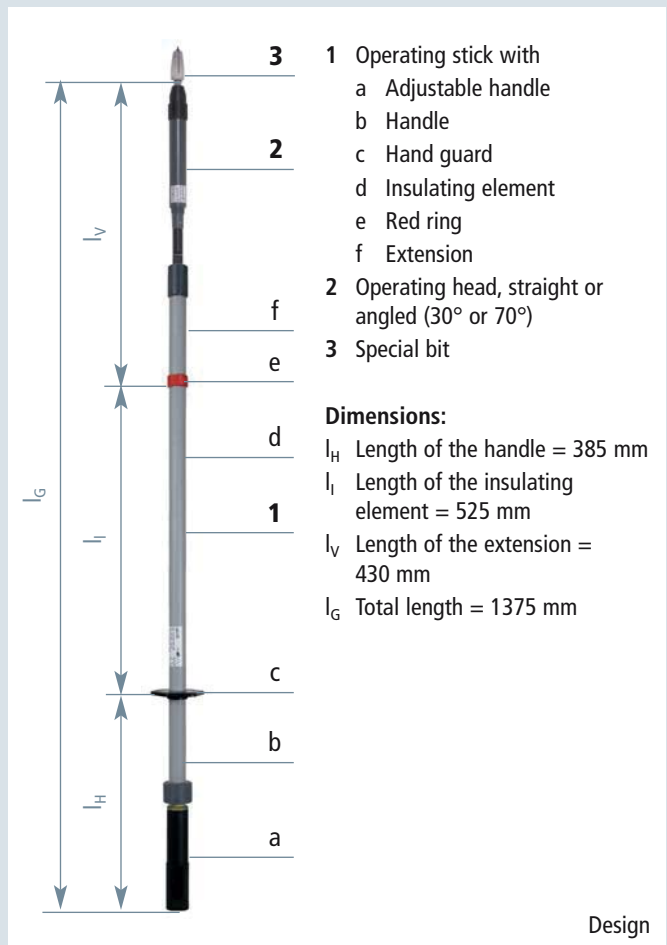

## Live Working

## MS Screw Driver Set

### Refilling Equipment

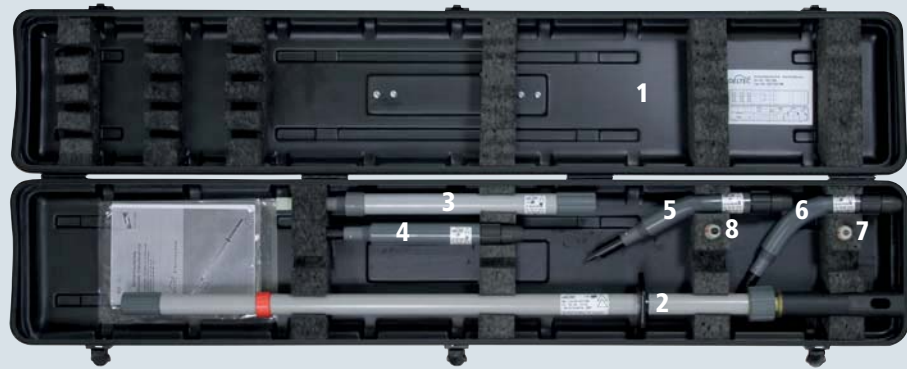

Fully equipped plastic case

<b>Type</b>	<b>SDS KEV MS</b>
<b>Part No.</b>	<b>785 265</b>
Dimensions	1270 x 215 x 140 mm
Material (operating head)	PVC
Material (handle)	Plastic
Material (insulating stick)	Glass-fibre reinforced polyester tube

Further insulating element extensions, operating heads and special bits are available on request.

### Single Parts for MS Screw Driver Set

#### Plastic Case, empty

With foam padding

<b>Type</b>	<b>KKL SDS KEV MS</b>
<b>Part No.</b>	<b>785 298</b>
Colour	Black
Dimensions	1270 x 215 x 140 mm



### Single Parts for MS Screw Driver Set

#### Operating Stick with adjustable Handle

With plug-in coupling for extending the handle, hand guard, insulating element, red ring and extension

<b>Type</b>	<b>BS SD KEV MS 1120</b>
<b>Part No.</b>	<b>785 266</b>
Diameter	30 mm
Dimensions	1135 mm



#### Extension

For operating sticks

<b>Type</b>	<b>VL 350 SD KEV MS</b>
<b>Part No.</b>	<b>785 273</b>
Diameter	30 mm
Dimensions	350 mm



#### Straight Operating Head

With hexagon socket for attaching special bits and special screw plugs

<b>Type</b>	<b>AK SD KEV MS</b>
<b>Part No.</b>	<b>785 267</b>
Diameter	30 mm
Dimensions	310 mm



#### 30° angled Operating Head

With hexagon socket for attaching special bits and special screw plugs

<b>Type</b>	<b>AK SD W30 KEV MS</b>
<b>Part No.</b>	<b>785 268</b>
Diameter	30 mm
Dimensions	270 mm



#### 70° angled Operating Head

With hexagon socket for attaching special bits and special screw plugs

<b>Type</b>	<b>AK SD W70 KEV MS</b>
<b>Part No.</b>	<b>785 269</b>
Diameter	30 mm
Dimensions	300 mm



#### Special Bit 13 mm

With safety plug-in system suitable for AK SD ... operating heads

<b>Type</b>	<b>BIT 13 SD KEV MS</b>
<b>Part No.</b>	<b>785 271</b>
Diameter	25 mm
Dimensions	50 mm



#### Special Bit 8 mm

With safety plug-in system suitable for AK SD ... operating heads

<b>Type</b>	<b>BIT 8 SD KEV MS</b>
<b>Part No.</b>	<b>785 272</b>
Diameter	25 mm
Dimensions	50 mm





## Special Screw Plugs

Live Working

Nominal voltages up to 36 kV

Refilling Equipment



Screwing a special screw plug into a cable sealing end using an angled operating head

- For indoor and outdoor installations
- For sealing cable sealing ends
- For use with operating heads of type AK SD ...
- With safety plug-in system
- UV-resistant

### General Information:

Use Not suitable for use in wet weather conditions

### Special Screw Plug (F & G)

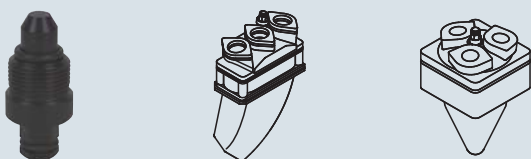

For cable sealing ends

Type	VS F&G M22 F
Part No.	785 281
Dimensions	M22 x 55 mm
PU	12 pc(s)

### Special Screw Plug (Köttgen)

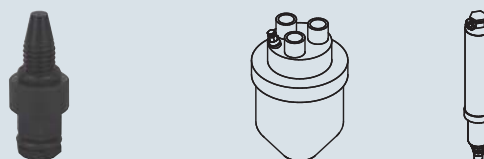

For cable sealing ends

Type	VS KOET M10
Part No.	785 282
Dimensions	M10 x 45 mm
PU	12 pc(s)

### Special Screw Plug (Raychem)

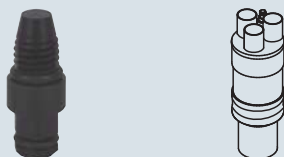

For cable sealing ends

Type	VS RAY M14
Part No.	785 283
Dimensions	M14 x 45 mm
PU	12 pc(s)

### Special Screw Plug (GOW)

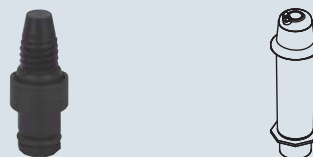

For cable sealing ends







Type	VS GOW M12
Part No.	785 284
Dimensions	M12 x 45 mm
PU	12 pc(s)

Special screw plugs for cable sealing ends from other manufacturers are available on request.

## Live Working

## Selection Guide

## Protective and Auxiliary Equipment

Device	Nominal voltage $U_N$	Application	Page	
DEHNcare APS	up to 1000 V	Arc-fault-tested face shield suitable for all standard safety helmets for electricians	150	
DEHNcare ESH		Insulating safety helmet for electricians (EN 50365) six-point suspension with sweatband		
DEHNcare APG		Arc-fault-tested protective gloves	152	
PPE – Personal Protective Equipment	up to 1000 V	Safety helmet NH fuse puller with sleeve Insulating gloves	154	
Covering Material	up to 1000 V	Insulated platform	156	
		Covering material Insulated mats for insulating the operating location	158	
	up to 50 kV		159	
Lock-out Systems	up to 1000 V	Insulating plugs Insulating blades Lock-out systems	160	

## DEHNcare APS and ESH

Live Working

Nominal voltages up to 1000 V

Protective and Auxiliary Equipment



Attaching an earthing and short-circuiting device using the required personal protective equipment

### Prevent injuries – Stay healthy

- High wearing comfort
- High degree of protection and low wear due to energy-absorbing nanoparticles
- Excellent visibility due to anti-mist coating and high light transmittance
- Face shield with clip for easy insertion into the helmet
- Certified according to the requirements of directive 89/686/EEC on personal protective equipment

### General Information:

Standard	EN 50365 (safety helmet for electricians), EN 166 and EN 177 (face shield), box test in accordance with IEC 61482-1-2, ATPV test in accordance with IEC 61482-1-1
----------	--



Use of the protective equipment



By pressing the rotary knob the head strap is loosened. If the rotary knob is turned, the head strap is adjusted to the head size of the user.

## Live Working

## DEHNcare APS and ESH

## Protective and Auxiliary Equipment

## Arc-fault-tested Face Shield with Clip and Chin Protector



Fits the slot in the ESH safety helmet for electricians

Type	APS CL2 SC	APS 12C SC
Part No.	785 746	785 747
Nominal voltage up to ( $U_N$ )	1000 V	1000 V
Material	Plastic	Plastic
Wall thickness	1.5 mm	1.5 mm
Incident energy after box test	(class 2) 423 kJ / m <sup>2</sup>	(class 2) 423 kJ / m <sup>2</sup>
ATPV (Arc Thermal Performance Value)	—	12 cal / cm <sup>2</sup>
Visible Light Transmittance (VLT)	> 75 %	65 % ... 75 %

## Arc-fault-tested Safety Helmet with Strap and Chin Protector



Suitable for all standard safety helmets for electricians

Type	APS CL2 FS	APS 12C FS
Part No.	785 748	785 749
Nominal voltage up to ( $U_N$ )	1000 V	1000 V
Material	Plastic	Plastic
Wall thickness	1.5 mm	1.5 mm
Incident energy after box test	(class 2) 423 kJ / m <sup>2</sup>	(class 2) 423 kJ / m <sup>2</sup>
ATPV (Arc Thermal Performance Value)	—	12 cal / cm <sup>2</sup>
Visible Light Transmittance (VLT)	> 75 %	65 % ... 75 %

## Safety Helmet for Electricians

- Electrically isolating safety helmet for electricians (EN 50365)
- For nominal voltages up to 1000 V
- With slot for APS ... SC face shield
- Adjustable to head sizes from 51 to 63 cm via push/rotary knob
- Six-point suspension with sweatband
- ABS shell



Type	ESH 1000 S Y	ESH 1000 S W	ESH 1000 S O	ESH 1000 S B	ESH 1000 S R
Part No.	785 740	785 741	785 742	785 743	785 744
Nominal voltage up to ( $U_N$ )	1000 V	1000 V	1000 V	1000 V	1000 V
Colour	Yellow	White	Orange	Blue	Red
Material	ABS plastic	ABS plastic	ABS plastic	ABS plastic	ABS plastic



Actuation of an NH fuse puller using protective gloves

**Prevent injuries – Stay healthy**

- For protection against thermal and mechanical risks
- Excellent fit due to special glove cut
- Good touch sensitivity due to soft leather inner surface of the gloves
- Breathable materials maximise wearing comfort
- Certified according to the requirements of directive 89/686/EEC on personal protective equipment

**General Information:**

Standard	Box test in accordance with IEC 61482-1-2, ATPV test in accordance with IEC 61482-1-1, DIN EN 388, DIN EN 407
Material (glove palm)	Siliconised calf grain leather
Material (glove back)	100% Kevlar® interlock knit
Material (sewing thread)	Kevlar®

**Notes**

Article 5 of the German Labour Protection Law requires employers to perform a hazard analysis. This hazard analysis also involves arc fault protection. Employers must select and provide approved protective clothing including helmets, face shields and gloves to protect personnel against the hazards of arc faults. They must also ensure that each employee who is exposed to the hazards of arc faults wears protective clothing. Protective gloves of type APG are no insulating gloves in accordance with EN/IEC 60903 (DIN VDE 0682 Part 311) for live working.



## Live Working

## DEHNcare APG

## Protective and Auxiliary Equipment

## Arc-Fault-Tested protective Gloves

## Glove size

Measure the circumference around your knuckles to determine your correct glove size.

## Order example

Glove size 10 is recommended for a circumference around your knuckles of 24 cm.

Glove size:	
Circumference around the knuckles	Glove size
20.3 cm	8
22.9 cm	9
25.4 cm	10
27.9 cm	11
30.5 cm	12



Type	APG 8	APG 9	APG 10	APG 11	APG 12
Part No.	785 796	785 797	785 798	785 799	785 800
Incident energy	(class 2) 423 kJ / m <sup>2</sup>	(class 2) 423 kJ / m <sup>2</sup>	(class 2) 423 kJ / m <sup>2</sup>	(class 2) 423 kJ / m <sup>2</sup>	(class 2) 423 kJ / m <sup>2</sup>
ATPV (Arc Thermal Performance Value)	32.8 cal / cm <sup>2</sup>	32.8 cal / cm <sup>2</sup>	32.8 cal / cm <sup>2</sup>	32.8 cal / cm <sup>2</sup>	32.8 cal / cm <sup>2</sup>
Total length	310 mm	320 mm	330 mm	340 mm	350 mm
Gauntlet length	100 mm	100 mm	100 mm	100 mm	100 mm
Size	8	9	10	11	12

## PPE – Personal Protective Equipment

## Live Working

Nominal voltages up to 1000 V

Protective and Auxiliary Equipment



Live working with insulating gloves up to 1000 V

- For working on live parts
- Insulating gloves combine excellent fit and high elasticity with maximum insulation resistance
- Two different models to suit your needs

### General Information:

Standard (gloves)	EN 60903 (DIN VDE 0682 Part 311)
Standard (face shield)	DIN EN 166 and additional GS-ET-29 requirements of the trade association
Standard (NH fuse puller)	DIN VDE 0680 Part 4

### Maintenance test

The pneumatic glove tester allows to perform maintenance tests in compliance with the relevant standard and even detects minimal damage to the insulating gloves. Gloves should be inspected before each use, therefore the glove tester is an indispensable and very practical safety tool.



### Face Shield with Strap



- Arc-fault-tested in accordance with GS-ET-29 test principle
- High Visible Light Transmittance (VLT)
- Coating on both sides prevents misting up, polished edges, 1.5 mm thick
- The face shield can be locked into the use and non-use position
- Suitable for all common safety helmets for electricians

Type	SSC ASH NS
Part No.	785 427
Nominal voltage up to ( $U_N$ )	1000 V
Wall thickness	1.5 mm
Size	Universal
Material	Plastic
Incident energy after box test	(class 1) 135 kJ / m <sup>2</sup>
Visible Light Transmittance (VLT)	> 75 %

### NH Fuse Puller with Sleeve



- NH fuse puller in accordance with DIN VDE 0680 Part 4 with sleeve made of coated cotton fabric
- For actuating fuses of sizes NH00, 1, 2 and 3

Type	NHS AG 00 3 NS
Part No.	785 645
Nominal voltage up to ( $U_N$ )	1000 V
Colour	Brown
Material	Coated cotton fabric

## Live Working

## PPE – Personal Protective Equipment

## Protective and Auxiliary Equipment

## Insulating Gloves, Category M



For high mechanical stress

Type	IHS 00 M 9 NS	IHS 00 M 10 NS	IHS 0 M 9 NS	IHS 0 M 10 NS
Part No.	785 491	785 492	785 493	785 494
Class	00	00	0	0
Nominal voltage up to ( $U_N$ )	500 V	500 V	1000 V	1000 V
Colour	Beige	Beige	Beige	Beige
Wall thickness	0.5 mm	0.5 mm	1.0 mm	1.0 mm
Size	9	10	9	10

## Insulating Gloves, Category RC



Resistant to acid, oil, ozone, high mechanical stress and extremely low temperatures

With inner coating and textured gripping surface

Type	IHS 00 RC 9 NS	IHS 00 RC 10 NS
Part No.	785 495	785 496
Class	00	00
Nominal voltage up to ( $U_N$ )	500 V	500 V
Colour	Orange	Orange
Wall thickness	0.9 mm	0.9 mm
Size	9	10

Sizes 8 and 11 are available on request.

## Accessory for insulating Gloves

## Storage Bag, empty

With hook-and-loop fastener and coupling hook

Type	AT IHS NS
Part No.	785 490
Colour	Brown
Dimensions	400 x 180 x 50 mm



## Accessory for insulating Gloves

## Pneumatic Glove Tester

For performing tests required by the standard

Type	PHSP NS
Part No.	785 497
Colour	Grey



# Insulating Equipment for Airport Lighting Systems

Live Working

Nominal voltages up to 17.5 kV / 15 ... 60 Hz

Protective and Auxiliary Equipment



Replacement of a faulty illuminant (airport lighting system) at a runway

- Equipment for live maintenance and repair work on airport lighting systems
- Insulated platform for insulating the operating location
- Circumferential, fluorescent marker tape indicates the maximum permissible height for plants in green spaces and can be used as reflector at night
- Two removable kneeling cushions for comfortable working
- Replaceable skids for easy positioning and transport



**General Information:**

Standard	Based on DIN VDE 0681 Part 1
Relative air humidity	≤ 90%
Temperature range	– 25 °C ... + 55 °C
Use	Not suitable for use in wet weather conditions
Material (insulated platform)	Glass-fibre reinforced plastic
Material (extension)	Glass-fibre reinforced rod

**Application**

The insulated platform and the insulating extension are used for e.g. replacing illuminants at airport lighting systems under live conditions. The insulated platform insulates the operating location during live working. The insulating extension is used as insulating intermediate section between the ratchet (with 13 mm square) and operating head (e.g. 17 mm bushing).



The insulating extension is used as insulating intermediate section when attaching the illuminant.

**Application:**

Insulating extension with operating head and ratchet with torque adjustment.



Insulating extension IV VK13 SW17 1000 Part No. 785 445

## Live Working

## Insulating Equipment for Airport Lighting Systems

## Protective and Auxiliary Equipment

## Insulating Insert for buried Beacons

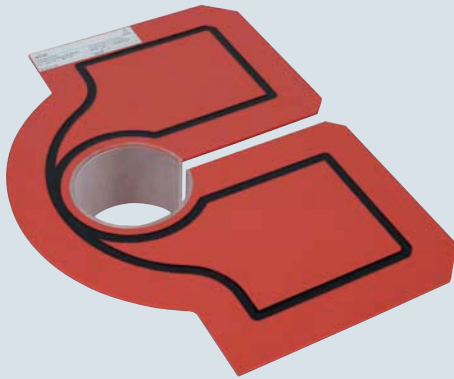

Type	IE UF LF 150	IE UF LF 200
Part No.	785 440	785 441
Nominal voltage up to ( $U_N$ )	1000 V / a.c.; 1500 V / d.c.	1000 V / a.c.; 1500 V / d.c.
Diameter	150 mm	200 mm
Dimensions	600 x 440 mm	600 x 460 mm

## IW insulated Platform

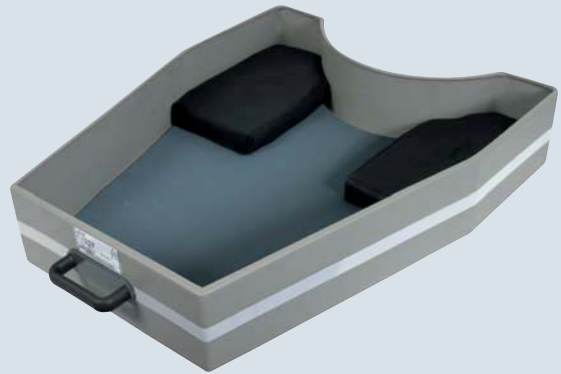

For beacons up to a maximum diameter of 225 mm

Type	IW 17.5 890 650 180
Part No.	785 408
Nominal voltage up to ( $U_N$ )	17.5 kV
Dimensions	890 x 650 x 180 mm

## Insulating Extension

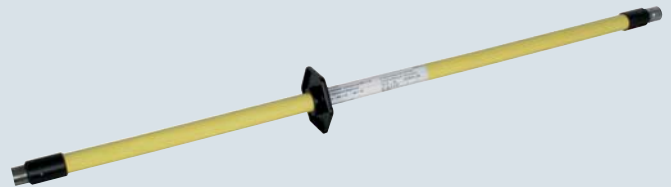

With 13 mm square and width across flats 17 for torque limiter

Type	IV VK13 SW17 1000
Part No.	785 445
Nominal voltage up to ( $U_N$ )	1000 V / a.c.; 1500 V / d.c.
Length	1000 mm



## Covering Material and insulated Mats

## Live Working

### Protective and Auxiliary Equipment



Covering live parts

- Protection against accidental and direct contact with live parts
- For covering adjacent live parts
- Available in different lengths, widths, thicknesses and colours
- Insulated rubber mats for insulating the operating location

#### General Information:

Standard DIN VDE 0680 Part 1

### Insulated Covering Material (Crystal Clear)



Type	ATK 135 50M NS	ATK 135 ..M NS
Part No.	785 465	785 466
Nominal voltage up to (U <sub>N</sub> )	1000 V	1000 V
Length	50 m	Any up to 50 m *)
Width	1350 mm	1350 mm
Thickness	0.5 mm	0.5 mm
Colour	Crystal clear	Crystal clear

### Insulated Covering Material (Transparent)



Type	ATK 120 25M NS	ATK 120 ..M NS
Part No.	785 467	785 468
Nominal voltage up to (U <sub>N</sub> )	1000 V	1000 V
Length	25 m	Any up to 25 m *)
Width	1200 mm	1200 mm
Thickness	1.0 mm	1.0 mm
Colour	Transparent	Transparent

\*) Required length to be specified at order!

## Live Working

## Covering Material and insulated Mats

## Protective and Auxiliary Equipment

## Insulated Covering Material (Chloroprene Rubber)



For covering insulators

Type	WBN 200 2,5M NS
Part No.	785 646
Nominal voltage up to ( $U_N$ )	1000 V
Length	2.5 m
Width	200 mm
Thickness	1.0 mm
Colour	Red

## Insulated Covering Material (Chloroprene Rubber)



Flexible at low temperatures

Type	ATN 140 10M NS	ATN 140 ..M NS
Part No.	785 471	785 472
Nominal voltage up to ( $U_N$ )	1000 V	1000 V
Length	10 m	Any up to 10 m *)
Width	1400 mm	1400 mm
Thickness	1.0 mm	1.0 mm
Colour	Red	Red

## Insulated Rubber Mats for Insulating the Operating Location

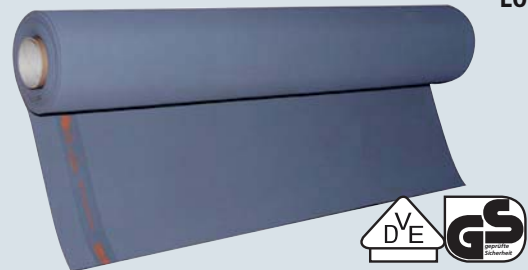

Type	IMG SI 1M NS	IMG SI 10M NS	IMG SI ..M NS
Part No.	785 455	785 457	785 456
Nominal voltage up to ( $U_N$ )	1000 V	1000 V	1000 V
Length	1 m	10 m	Any up to 10 m *)
Width	1000 mm	1000 mm	1000 mm
Thickness	3.0 mm	3.0 mm	3.0 mm
Colour	Grey	Grey	Grey

## Accessory for Covering Material and insulated Mats

## Clip

With insulated steel spring

With VDE/GS sign

Type	KK 35 NS
Part No.	785 647
Max. clamping range	35 mm
Dimensions	170 / 110 mm
Material	Plastic



## Eye

Consists of two elements

Type	OEK 12 NS
Part No.	785 649
Dimensions	Ø12 / 26 mm
Material	Plastic



## Hook

Type	HK 8 NS
Part No.	785 648
Dimensions	Ø8, 130 / 72 mm
Material	Plastic



## Insulated Mats up to 50 kV

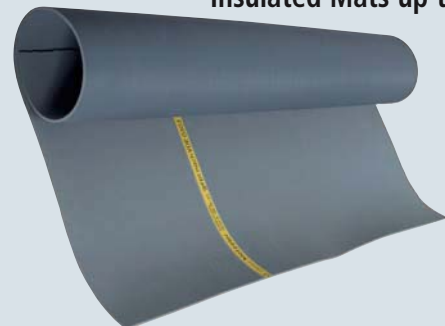

For use in electrical control and test rooms, dielectric strength of 50 kV, tested to DIN VDE 0303 Part 21

Type	IMG SAN 1M 10M	IMG SAN 1M ..M
Part No.	785 459	785 458
Nominal voltage up to ( $U_N$ )	50 kV	50 kV
Length	10 m	Any up to 10 m *)
Width	1000 mm	1000 mm
Thickness	4.5 mm	4.5 mm
Colour	Grey	Grey

\*) Required length to be specified at order!

## Lock-out Systems

Live Working

Nominal voltages up to 1000 V

Protective and Auxiliary Equipment



Lock-out system with 3 modules

- Protection against reconnection
- Symbol "Nicht schalten" [Do not close the circuit] acc. to German regulations (VGB 125)
- Insulating plug for screw inserts
- Insulating blade for NH fuse holders
- Lock-out systems for circuit breakers



### General Information:

Standard	VGB 125 and DIN 40008
For	Indoor installations

## Insulating Plug



For screw inserts

Type	SE E14	SE E18	SE E27 E33
Part No.	785 639	785 650	785 640
Size	E14	E18	E27 and 33
Diameter	20 mm	25 mm	45 mm
Dimensions	∅20 x 40 mm	∅25 x 40 mm	∅45 x 55 mm

## Insulating Blade



For NH fuse holders and distribution blocks

Type	SE NH00	SE NH0	SE NH1	SE NH2 3
Part No.	785 641	785 642	785 643	785 644
Size	00	0	1	2 and 3
Blade	38 x 5	38 x 5	38 x 5	38 x 5
Dimensions	80 mm	125 mm	135 mm	150 mm

## Lock-out System



For single-pole and multipole circuit breakers with a clamping range of 45 mm

Type	SE REG 1TE	SE REG 2TE	SE REG 3TE
Part No.	785 638	785 652	785 637
Size	1 module	2 modules	3 modules
Dimensions	52 x 17 mm	52 x 34 mm	52 x 51 mm

## Voltage Detector

Device	Nominal Voltage $U_N$ / Frequency $f_N$	Application, Indication	Page
PHE Kit	15 kV / 16.7 Hz	For use in wet weather conditions For overhead contact lines of electric railways With self-testing element Visual indicator Easy transport 4 / 6-part unit	162
PHE III	25 kV / 50 Hz	For use in wet weather conditions For overhead contact lines of electric railways With self-testing element Visual and acoustic indicator Easy transport	164
PHE	3...20 kV / 50 or 16.7 Hz, switchable 6...20 kV / 16.7 Hz 15 kV / 16.7 Hz	For use in wet weather conditions For use in three-phase systems and single-ended mono phase switching stations For traction power lines With self-testing element Visual indicator Easy transport	165
PHE III Kit	110...132 kV / 50 and 16.7 Hz	For use in wet weather conditions For indoor and outdoor installations For use in 50 Hz three-phase systems and 16.7 Hz centre-earthed monophas traction power lines With self-testing element Visual and acoustic indicator Easy transport	167
HSA 194	110...420 kV / 16.7 Hz	For use in wet weather conditions Non-contact voltage detector	168
ASP	110...132 kV / 16.7 Hz	For centre-earthed monophas traction power lines With self-testing element Visual and acoustic indicator	169
PHE/G	1...24 kV / d.c. voltage	For use in wet weather conditions For indoor and outdoor installations With self-testing element Visual indicator Easy transport Two-pole unit (one stick/two sticks)	170
Storage Bags and Transport Cases			187

## Maintenance tests according to GUV-V A2

According to German regulations (GUV-V A2), voltage detectors have to be tested for compliance with the prescribed limits as stated in the Electrical Safety Rules. This test is performed in the high-voltage test laboratory of DEHN + SÖHNE and includes

- measurement of the leakage current,
- test for clear indication,
- test for protection against bridging,
- visual inspection, manual tests and measurements.

This maintenance test is documented in a test report and on the device.

The test intervals depend on the operating conditions of the voltage detector, e.g. frequency of use, environmental conditions and transport. According to German regulations, however, it is advisable to carry out a maintenance test **at least every 6 years**.



## PHE Voltage Detector Kit

Safety Equipment for electric Railway

Nominal voltage 15 kV / 16.7 Hz

Voltage Detectors



PHE voltage detector with visual indicator used on an overhead contact line of National German National Railways (DB)

### Easy and safe testing

- For overhead contact lines of electric railways
- Cost-effective/space-saving transport
- Easy to use due to simple plug-in system



#### General Information:

Standard	DIN VDE 0681 Part 6
Use	Suitable for use in wet weather conditions
Self-testing element	Yes
Material (test electrode)	St/gal Zn
Material (test prod)	Glass-fibre reinforced polyester tube
Material (indicator)	Plastic, fully insulated
Material (insulating stick)	Glass-fibre reinforced polyester tube

#### Kit includes:

Pos. No.	Part No.	Pos. No.	Part No.
1	766 619	7	766 076
2	766 678	8	766 077
3	766 677	9	766 889
4	766 072	10	766 602
5	766 075	11	766 704
6	766 073		

For more detailed information on these products, see Accessory chapter



Insulating stick with anti-rotation plug-in coupling



End fitting with plug-in coupling and non-slip eye

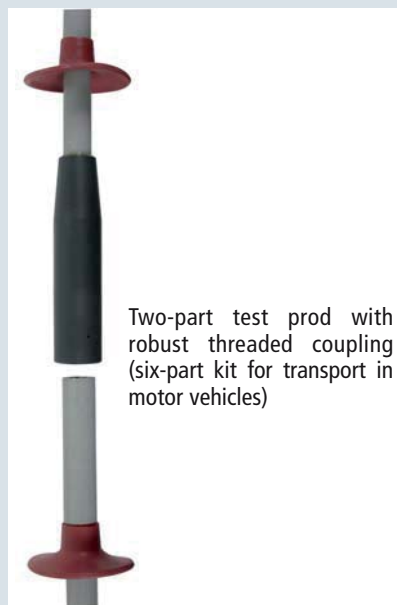

Two-part test prod with robust threaded coupling (six-part kit for transport in motor vehicles)



Safety Equipment for electric Railway

**PHE Voltage Detector Kit**

Voltage Detectors

Nominal Voltage 15 kV / 16.7 Hz

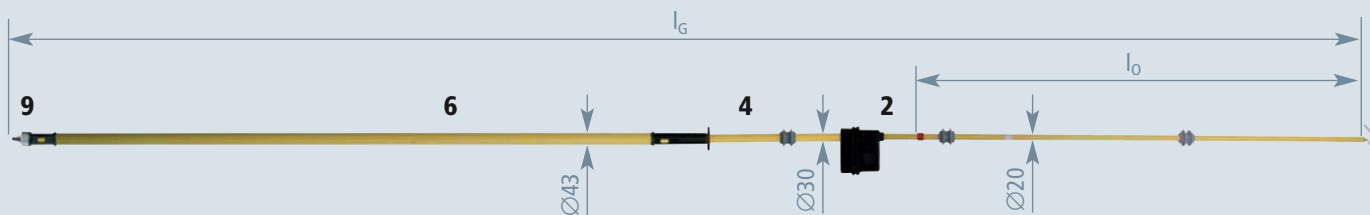

Modular (four elements)

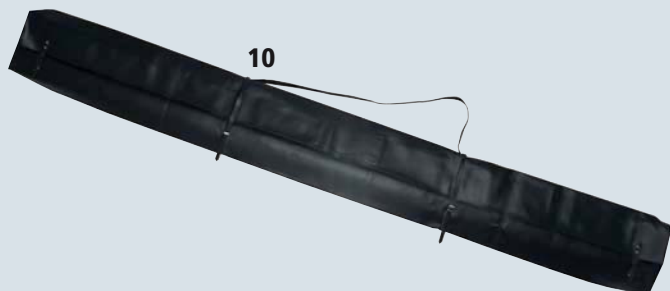

Type	PHE 15 16.7 4T TA
Part No.	766 616
Nominal voltage ( $U_N$ )	15 kV
Frequency	16.7 Hz
Total length ( $l_G$ )	4890 mm
Insertion depth ( $l_o$ )	1675 mm
DB drawing No.	3 Ebgw 02.51
DB material No.	237 129

Nominal Voltage 15 kV / 16.7 Hz (for Transport in Motor Vehicles)

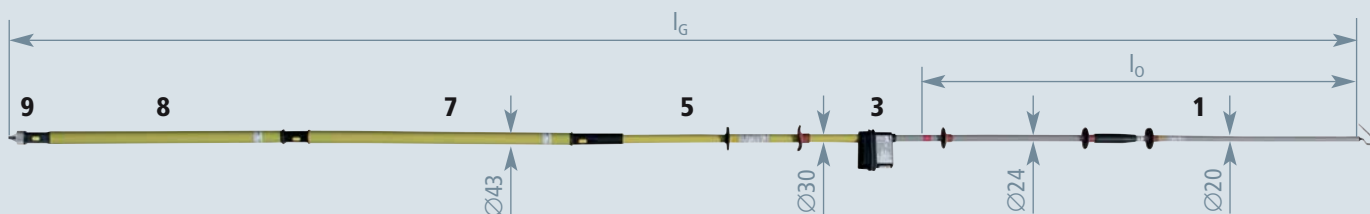

Modular (six elements)



Type	PHE 15 16.7 6T TA
Part No.	766 617
Nominal voltage ( $U_N$ )	15 kV
Frequency	16.7 Hz
Total length ( $l_G$ )	4900 mm
Insertion depth ( $l_o$ )	1675 mm
DB drawing No.	3 Ebgw 02.53
DB material No.	652 975

Voltage detectors for other nominal voltages and frequencies are available on request.

## PHE III Voltage Detector

Safety Equipment for electric Railway

Nominal voltage 25 kV / 50 Hz

Voltage Detectors



### Easy and safe testing

- For overhead contact lines of electric railways
- Reliable indication
- Cost-effective/space-saving transport
- Easy to use due to simple plug-in system



### General Information:

Standard	EN/IEC 61243-1 (DIN VDE 0682 Part 411)
Temperature range	- 25 °C ... + 55 °C, climatic category N
Use	Suitable for use in wet weather conditions
Indication	Visual and acoustic
Self-testing element	Yes
Material (test electrode)	Copper alloy/gal Sn
Material (test prod)	Glass-fibre reinforced epoxy resin tube
Material (indicator)	Plastic, fully insulated
Material (insulating stick)	Glass-fibre reinforced polyester tube

## Nominal Voltage 25 kV / 50 Hz

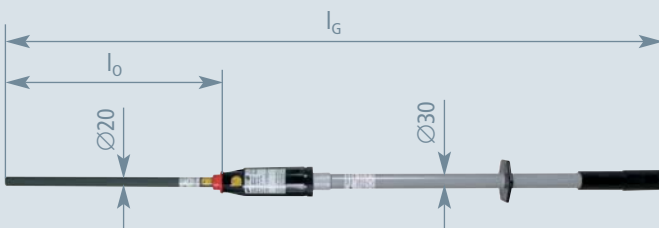

Category "S" for single-ended monophasic systems

Type	PHE3 25 S 50 1P
Part No.	767 125
Nominal voltage (U <sub>N</sub> )	25 kV / 50 Hz
Category	S
Total length (l <sub>G</sub> )	1680 mm
Insertion depth (l <sub>0</sub> )	880 mm



Plugging a HV STK extension handle into an IS PHE STK insulating stick

## Voltage Detectors

Nominal voltage ranges 3 ... 20 kV / 50 Hz and 6 ... 20 kV / 16.7 Hz

- Safe verification of isolation from supply voltage
- For three-phase and single-ended monophas systems
- For electric point heating systems
- Reliable indication
- Cost-effective/space-saving transport
- Universal device with different nominal ranges



PHE voltage detector with visual indicator used on a switchgear installation

## General Information:

Standard	EN/IEC 61243-1 (DIN VDE 0682 Part 411) and E DIN VDE 0682 Part 421
Temperature range	- 25 °C ... + 55 °C, climatic category N
Use	Suitable for use in wet weather conditions
Indication	Visual
Self-testing element	Yes
Material (test electrode)	Copper alloy/gal Sn
Material (test prod)	Glass-fibre reinforced epoxy resin tube
Material (indicator)	Plastic, fully insulated
Material (insulating stick)	Glass-fibre reinforced polyester tube

## Nominal Voltage Ranges up to 20 kV / 50 Hz or 16.7 Hz, switchable

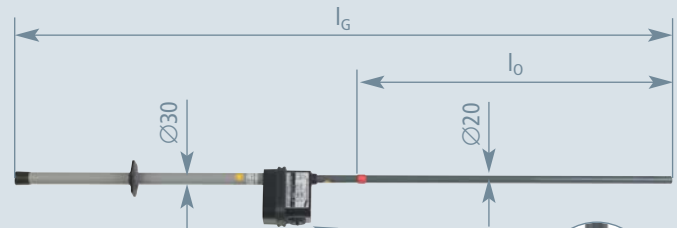

For three-phase systems and single-ended monophas switchgear installations

## Special features of the switchable voltage detector:

The selector switch can be moved into three positions for the relevant voltage/frequency ranges:

- 3 ... 10 kV / 50 Hz – Three-phase current
- 6 ... 20 kV / 50 Hz – Three-phase current
- 6 ... 20 kV / 16.7 Hz – Single-ended monophas systems

For safety reasons, the detector can only be switched on if the selector switch is switched to the most sensitive range of 3 kV to 10 kV / 50 Hz. The switch snaps into the relevant position and provides protection against accidental switching.

A magnetically operated, wear-resistant reed switch changes the switching position.

## Nominal Voltage Ranges up to 20 kV / 16.7 Hz

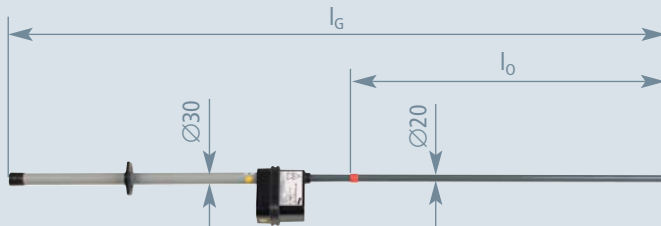

For single-ended monophas switchgear installations and point heating systems

Type	PHE 6 20 S 16.7 1P
Part No.	767 415
Nominal voltage / frequency ( $U_N / f_N$ )	6 ... 20 kV / 16.7 Hz
Total length ( $l_G$ )	1590 mm
Insertion depth ( $l_o$ )	770 mm
DB drawing No.	3 Ebgw 02.52
DB material No.	738 302

Type	PHE 3 20 S FU 1P
Part No.	767 416
Nominal voltage / frequency ( $U_N / f_N$ )	3 ... 10 kV / 50 Hz; 6 ... 20 kV / 50 Hz; 6 ... 20 kV / 16.7 Hz
Total length ( $l_G$ )	1590 mm
Insertion depth ( $l_o$ )	770 mm
DB drawing No.	3 Ebgw 02.54
DB material No.	743 361

Voltage detectors for other nominal voltages and frequencies are available on request.

## PHE Voltage Detector

Safety Equipment for electric Railway

Nominal voltage 15 kV / 16.7 Hz

Voltage Detectors



### Easy and safe testing

- Specifically for traction power lines
- Easy to use
- Cost-effective/space-saving transport



### General Information:

Standard	EN/IEC 61243-1 (DIN VDE 0682 Part 411)
Temperature range	- 25 °C ... + 55 °C, climatic category N
Use	Suitable for use in wet weather conditions
Indication	Visual
Self-testing element	Yes
Material (test electrode)	Copper alloy/gal Sn
Material (test prod)	Glass-fibre reinforced epoxy resin tube
Material (indicator)	Plastic, fully insulated
Material (insulating stick)	Glass-fibre reinforced polyester tube

## Nominal Voltage 15 kV / 16.7 Hz

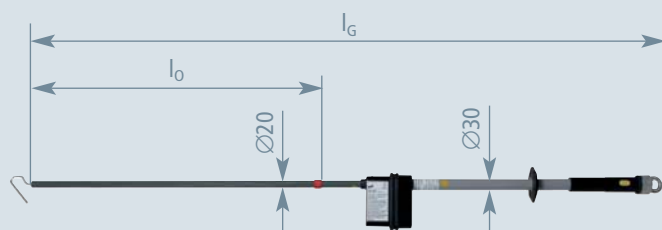

Hook-shaped electrode and end fitting included

Type	PHE 15 16.7 BEL STK
Part No.	767 413
Nominal voltage / frequency ( $U_N / f_N$ )	15 kV / 16.7 Hz
Total length ( $l_G$ )	1645 mm
Insertion depth ( $l_0$ )	765 mm
DB drawing No.	3 Ebgw 02.55
DB material No.	964 851

Voltage detectors for other nominal voltages and frequencies are available on request.

### Use for traction power lines

Voltage detectors for traction power lines have a shorter extension than voltage detectors for overhead contact lines. To ensure reliable indication, the PHE 15 16.7 BEL STK voltage detector may only be used for railway power lines, but not for other components of overhead contact lines. Moreover, it must not be used from ladder trolleys for overhead contact lines.

Traction power lines are supply lines, line feeders, bypass lines, connecting lines, feeder lines, 15 kV cables, cable sealing ends, switch lines and transverse switch lines.



End fitting with plug-in coupling and non-slip eye

## Voltage Detectors

## Safe verification of isolation from supply voltage

- Voltage detector for 50 Hz three-phase systems and 16.7 Hz centre-earthed monophaser traction power lines
- Range does not have to be switched
- Cost-effective
- Cost-effective/space-saving transport



PHE III voltage detector used on a 110 kV outdoor switching station

## Kit includes:

Pos. No.	Part No.	Pos. No.	Part No.
1	766 924	5	766 128
2	767 771	6	766 120
3	767 129	7	766 889
4	766 352	8	766 996

For more detailed information on these products, see Accessory chapter

## General Information:

Standard	EN/IEC 61243-1 (DIN VDE 0682 Part 411)
Temperature range	- 25 °C ... + 55 °C, climatic category N
Use	Suitable for use in wet weather conditions
For	Indoor and outdoor installations
Indication	Visual and acoustic
Self-testing element	Yes
Material (test electrode)	Copper alloy/gal Sn
Material (test prod)	Glass-fibre reinforced epoxy resin
Material (indicator)	Plastic, fully insulated
Material (insulating stick)	Glass-fibre reinforced polyester tube

## Nominal Voltage Range 110 ... 132 kV / 50 and 16.7 Hz

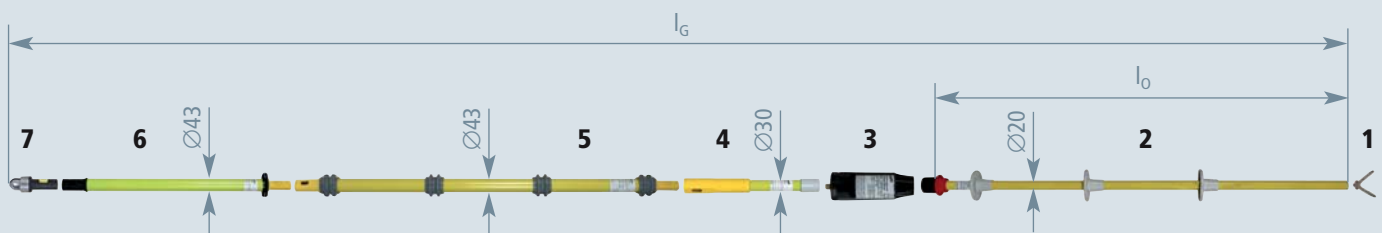

## Kit includes:

Type	Part No.	No.
PHE3 110 132 S	767 130	1+2+3+4+5+6+7
KLT 133 34 10	766 996	8

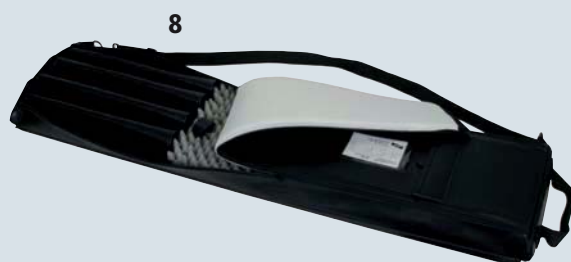

Type	PHE3S 110 132 S
Part No.	767 131
Nominal voltage ( $U_N$ )	110 ... 132 kV
Category	S
Total length ( $l_G$ )	3440 mm
Insertion depth ( $l_0$ )	880 mm
DB drawing No.	3 Eku 710 001
DB material No.	01 101 358

Voltage detectors for other nominal voltages and frequencies are available on request.

Accessory, kit parts and spare parts from page 195



## HSA 194 Non-Contact Voltage Detector

Safety Equipment for electric Railway

Nominal voltage range 110 ... 420 kV / 16.7 Hz

Voltage Detectors



Non-contact voltage detector used for a 110 kV overhead line

### Easy and safe testing

- For verifying safe isolation from supply voltage of centre-earthed monophasic traction power lines without making contact
- Cost-effective/space-saving transport



### General Information:

Temperature range	- 25 °C ... + 55 °C, climatic category N
Use	Suitable for use in wet weather conditions
Indication	Visual and acoustic
Self-testing element	Yes
Material (insulating stick)	Glass-fibre reinforced polyester tube

### Nominal Voltage Range 110 ... 420 kV / 16.7 Hz

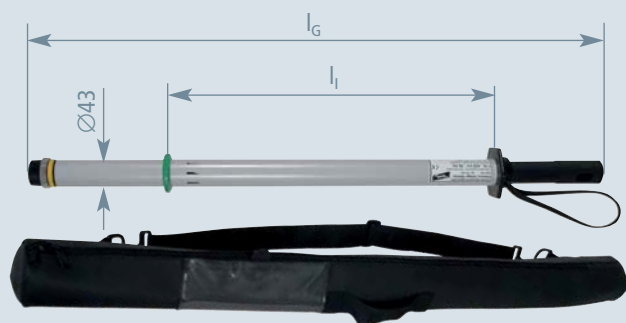

Plug-in coupling for extending the handle  
Storage bag included in delivery

Type	HSA194 110 420 16.7
Part No.	767 542
Nominal voltage range ( $U_N$ )	110 ... 420 V
Total length ( $l_G$ )	935 mm
Insulating clearance ( $l_I$ )	540 mm
DB drawing No.	3 Ekgw 02.54

If required, non-contact voltage detectors can be equipped with lithium batteries at an extra charge and are available for other nominal voltages and frequencies on request.

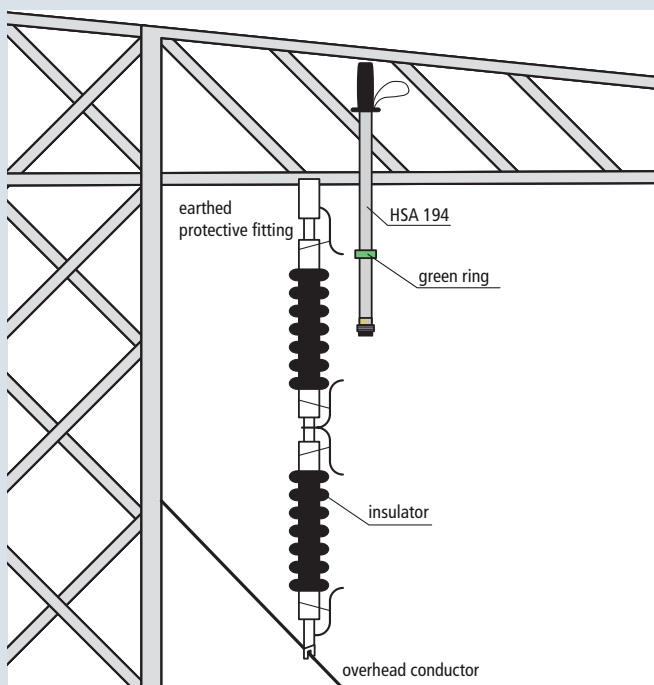

### Application notes

The HSA 194 non-contact voltage detector is used for verifying safe isolation from supply voltage from the crossarm of the overhead line tower. The green ring on the HSA 194 is used to make contact with the last earthed protective fitting (or earthed insulator cap) so that the measuring head of the voltage detector points in the direction of the overhead conductor fixed to the other end of the insulator (stick axis of the HSA 194 parallel to the longitudinal axis of the insulator). The "Voltage present" state of the overhead conductor is indicated by visual (red flashing light) and acoustic (audible signal) signals.

Safety Equipment for electric Railway

Voltage Detectors

Easy and safe testing

- For verifying safe isolation from supply voltage of centre-earthed monophas traction power lines without making contact
- Cost-effective
- Cost-effective/space-saving transport



Devices of category "L" can only be used for overhead lines.

Kit includes:			
Pos. No.	Part No.	Pos. No.	Part No.
1	767 576	3	766 369
2	767 564	4	767 574
For more detailed information on these products, see Accessory chapter			

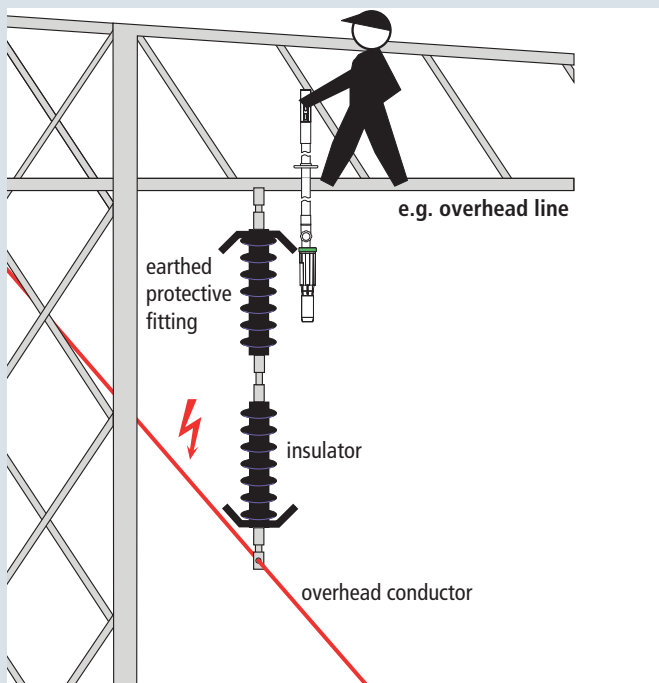

Use for overhead lines

The green ring on the ASP non-contact voltage detector with category "L" electric field sensor is used to make contact with the last earthed protective fitting in such a way that the electric field sensor points in the direction of the overhead conductor fixed at the other end of the insulator.

ASP Non-Contact Voltage Detector Kit

Nominal voltage range 110 ... 132 kV / 16.7 Hz



General Information:

Temperature range	- 25 °C ... + 55 °C
Use	Suitable for use in wet weather conditions
For	Overhead lines
Indication	Visual and acoustic
Self-testing element	Yes
Material (indicator)	Plastic, fully insulated
Material (electric field sensor)	Plastic (black)
Material (insulating stick)	Glass-fibre reinforced polyester tube

Nominal Voltage Range 110 ... 132 kV / 16.7 Hz

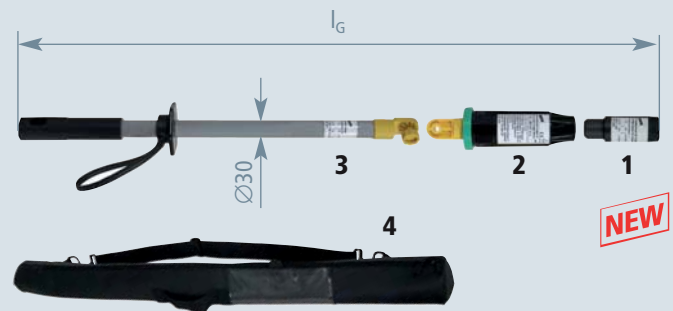

Kit includes:		
Type	Part No.	No.
ASP 110 132 16.7 L	767 585	1+2+3
KLT 104 9	767 574	4

Category "L" for overhead lines

Type	ASPS 110 132 16.7 L
Part No.	767 565
Nominal voltage (U <sub>N</sub> )	110 ... 132 kV
Frequency	16.7 Hz
Total length (l <sub>G</sub> )	960 mm
Category	L
DB drawing No.	3 Eku 710 002

Voltage detectors for other nominal voltages and frequencies are available on request.

## PHE/G d.c. Voltage Detector

Safety Equipment for electric Railway

Nominal voltage up to 24 kV d.c.

Voltage Detectors



PHE/G II d.c. voltage detector for d.c. links (ICE power car)

Safe verification of isolation from supply voltage

- For use in direct voltage systems (electrified rail networks, d.c. links)
- Reliable indication
- Easy to use due to compact design
- User-friendly



### General Information:

Standard	Based on EN/IEC 61243-2 (DIN VDE 0682 Part 412)
Temperature range	- 25 °C ... + 55 °C, climatic category N
Use	For use in wet weather conditions
For	Indoor and outdoor installations, for example d.c. voltage systems (electrified rail networks, d.c. links)
Indication	Visual
Self-testing element	With self-testing element
Material (test prod)	Glass-fibre reinforced polyester tube
Material (indicator)	Plastic, fully insulated
Material (insulating stick)	Glass-fibre reinforced polyester tube
Material (earthing/ connecting cable)	Copper cable, highly flexible

The test prod of d.c. voltage detectors is colour-coded according to the polarity of the test prod:

- positive pole – red;
- negative pole – blue.

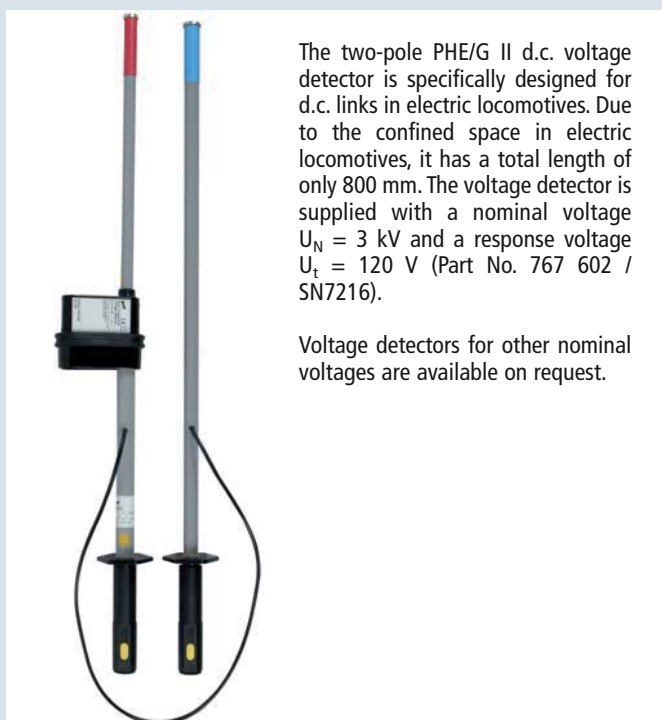

The two-pole PHE/G II d.c. voltage detector is specifically designed for d.c. links in electric locomotives. Due to the confined space in electric locomotives, it has a total length of only 800 mm. The voltage detector is supplied with a nominal voltage  $U_N = 3 \text{ kV}$  and a response voltage  $U_t = 120 \text{ V}$  (Part No. 767 602 / SN7216).

Voltage detectors for other nominal voltages are available on request.



Earth clamp with adjustable handle and magnet

Safety Equipment for electric Railway

PHE/G d.c. Voltage Detector

Voltage Detectors

PHE/G I for Overhead Contact Lines, positive Pole

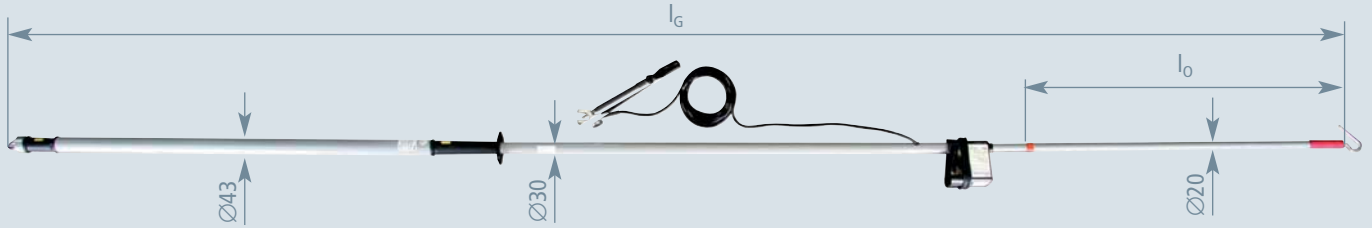

One stick (four elements)

- For direct voltage systems with earthed negative pole
- For nominal voltages up to 24 kV d.c.
- Positive pole: Indicator with test prod
- Negative pole: Earth clamp
- Response voltage  $U_t = 0.5 \times U_N$
- **Nominal voltage ( $U_N$ ) to be specified at order!**

Type	PHEG1.FD P SN7...
Part No.	767 650
Length (earthing cable)	6000 mm
Total length ( $l_G$ )	4120 mm
Insertion depth ( $l_0$ )	1020 mm

PHE/G I for Overhead Contact Lines, negative Pole

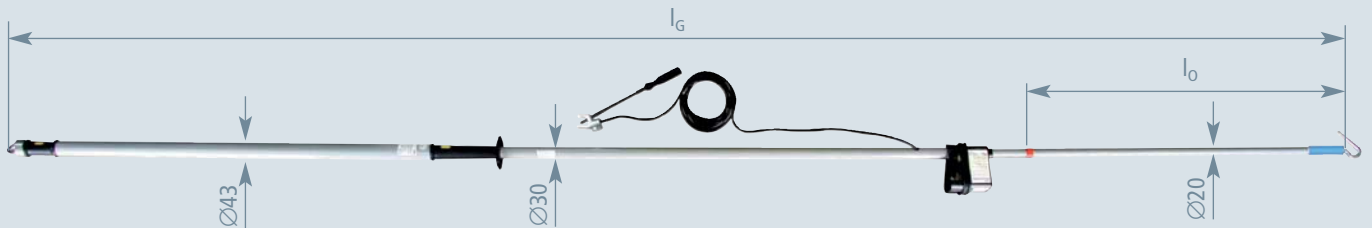

One stick (four elements)

- For direct voltage systems with earthed positive pole
- For nominal voltages up to 24 kV d.c.
- Negative pole: Indicator with test prod
- Positive pole: Earth clamp
- Response voltage  $U_t = 0.5 \times U_N$
- **Nominal voltage ( $U_N$ ) to be specified at order!**

Type	PHEG1.FD M SN7...
Part No.	767 655
Length (earthing cable)	6000 mm
Total length ( $l_G$ )	4120 mm
Insertion depth ( $l_0$ )	1020 mm

PHE/G I for Switchgear Installations, positive Pole

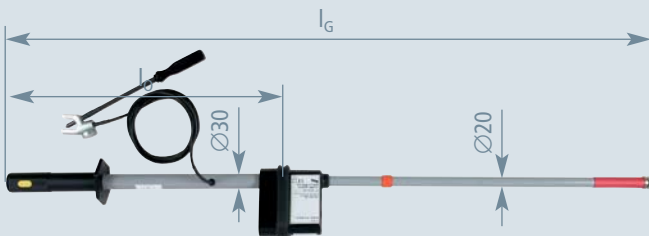

One stick

- For direct voltage systems with earthed negative pole
- For nominal voltages up to 24 kV d.c.
- Positive pole: Indicator with test prod
- Negative pole: Earth clamp
- Response voltage  $U_t = 0.5 \times U_N$
- **Nominal voltage ( $U_N$ ) to be specified at order!**

Type	PHEG1.S P SN7...
Part No.	767 660
Length (earthing cable)	2000 mm
Total length ( $l_G$ )	1260 mm
Insertion depth ( $l_0$ )	530 mm

PHE/G I for Switchgear Installations, negative Pole

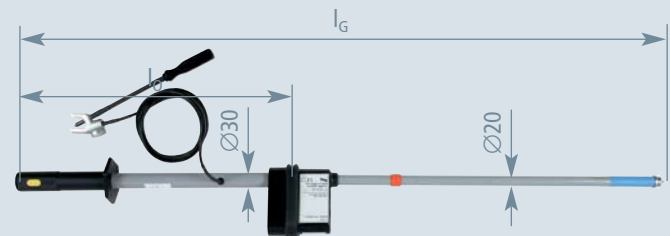

One stick

- For direct voltage systems with earthed positive pole
- For nominal voltages up to 24 kV d.c.
- Negative pole: Indicator with test prod
- Positive pole: Earth clamp
- Response voltage  $U_t = 0.5 \times U_N$
- **Nominal voltage ( $U_N$ ) to be specified at order!**

Type	PHEG1.S M SN7...
Part No.	767 665
Length (earthing cable)	2000 mm
Total length ( $l_G$ )	1260 mm
Insertion depth ( $l_0$ )	530 mm

## PHE/G d.c. Voltage Detector

### PHE/G II for Switchgear Installations and d.c. Links up to 24 kV d.c.

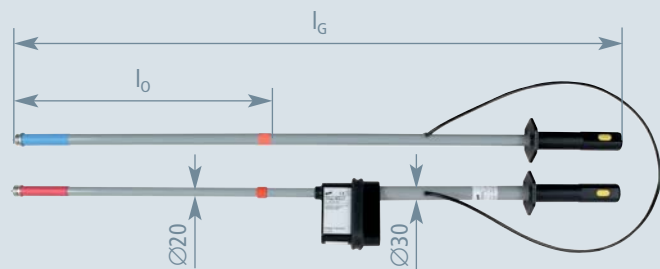

Two sticks

- For unearthed direct voltage systems
- For nominal voltages up to **24 kV d.c.**
- For d.c. links
- Positive pole: Indicator with test prod
- Negative pole: Insulating stick
- Response voltage  $U_t = 0.5 \times U_N$
- **Nominal voltage ( $U_N$ ) to be specified at order!**

Type	PHEG2.P SN7...
Part No.	767 670
Length (connecting cable)	1250 mm
Total length ( $l_G$ )	1250 mm
Insertion depth ( $l_0$ )	540 mm

### PHE/G II for Switchgear Installations and d.c. Links up to 7.5 kV d.c.

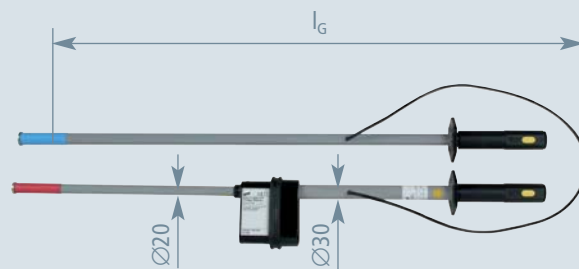

Two sticks







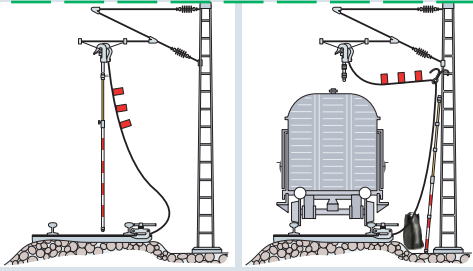
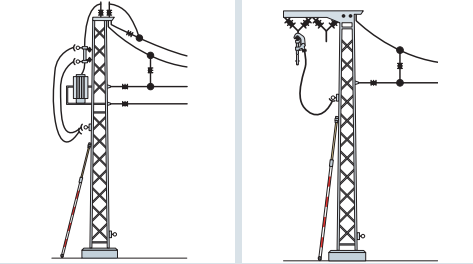
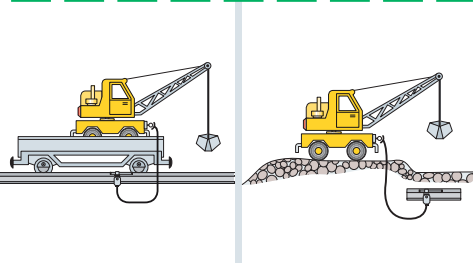
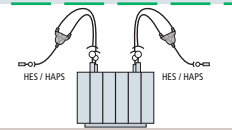

- For unearthed direct voltage systems
- For nominal voltages up to **7.5 kV d.c.**
- For d.c. links (e.g. electric locomotive;  $U_A \leq 120 \text{ V}$ ,  $l_G = 800 \text{ mm}$ )
- Positive pole: Indicator with test prod
- Negative pole: Insulating stick
- Response voltage  $U_t = 0.5 \times U_N$
- **Nominal voltage ( $U_N$ ) to be specified at order!**

Type	PHEG2 P SN7...
Part No.	767 602
Length (connecting cable)	1200 mm
Total length ( $l_G$ )	1075 mm

Other lengths and response values ( $U_t$ ) are available on request.

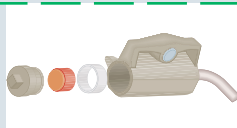

## Earthing Devices

Device	Application, Device	Page	
Kit for Overhead Contact Lines	Profile-free or non-profile-free Kit for transport in motor vehicles (profile-free or non-profile-free)	174	
Kit for Transformers at Overhead Contact Line Towers	For earthing at fuse carriers For earthing towers next railway tracks	176	
Kit for Construction Machines, Lifting Gear, Maintenance Vehicles	For equipment on maintenance vehicles For on-track equipment For off-track equipment	177	
Kit for electric Point and Train Pre-Heating Systems	For electrical point heating systems For electrical train pre-heating systems	178	
Single Parts of Railway Earthing Devices	Earthing and short-circuiting devices	178	
	Phase connecting elements	180	
	Earth connecting elements	181	
	Earthing sticks	182	
	Fix ball points, earth connecting plates	183	
Further Equipment Insulating Stick Kit	For cleaning the windscreens of electric locomotives	185	
Fuse Link	For voltage-limiting devices	186	
Storage Bags and Transport Cases	Sheet metal or plastic case Artificial leather or canvas bag	187	

## Kit for Overhead Contact Lines

Safety Equipment for electric Railways

### Non-profile-free and profile-free

Earthing Devices

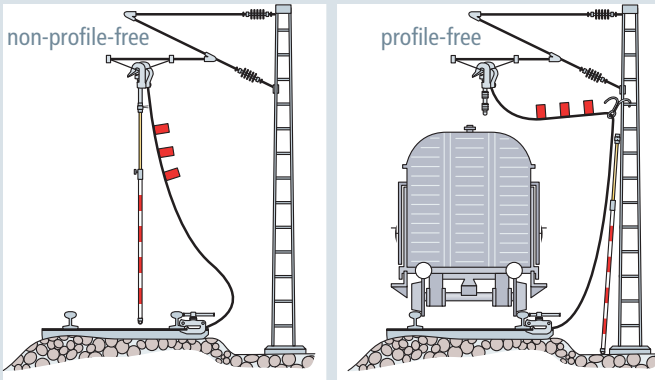

Kit includes:			
Pos. No.	Part No.	Pos. No.	Part No.
1	784 755	5	740 124
2	792 450	6	769 502
2*	792 453	7	769 508
3	751 085	8	769 506
4	751 120	9	785 111

#### General Information:

Standard EN/IEC 61230 (DIN VDE 0683 Part 100)

### Kit for Overhead Contact Lines (non-profile-free)

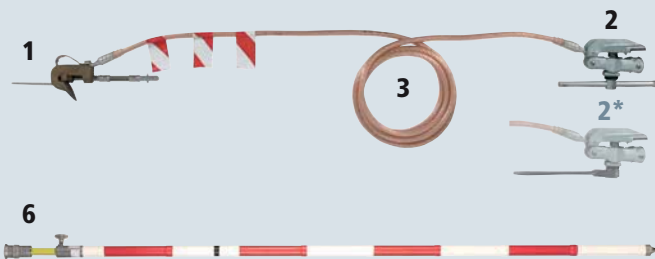

Telescopic earthing stick with adjusting ring (max. 5 m long), single-pole earthing and short-circuiting device (tommy bar)

Kit includes:			
Type	Part No.	No.	
ESTC SQL RW 5000	1x 769 502	6	
EKV K 50 8500	1x 751 086	1+2+3	
EKV R 50 8500	- 751 087	1+2*+3	

\* Version with ratchet is available on request

Type	BEV OL NPF K
Part No.	750 210
Cable cross-section	50 mm <sup>2</sup>
Cable length	8500 mm
DB drawing No.	3 Ebgw 01.51
DB material No.	237 117

### Kit for Overhead Contact Lines for Transport in Motor Vehicles (non-profile-free)

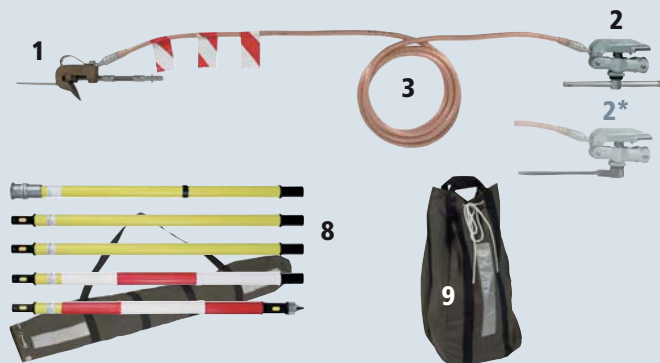

#### For technical emergency service and emergency management

Telescopic earthing stick kit consisting of six elements, pluggable (max. 5 m long), (canvas bag (Part No. 769 509) included), single-pole earthing and short-circuiting device (tommy bar), canvas bag

Kit includes:			
Type	Part No.	No.	
EST SQL RW 4915 TA	1x 769 506	8	
EKV K 50 8500	2x 751 086	1+2+3	
EKV R 50 8500	- 751 087	1+2*+3	
STT 55 27 30	1x 785 111	9	

\* Version with ratchet is available on request

Type	BEV OL NPF PKW K
Part No.	750 196
Cable cross-section	50 mm <sup>2</sup>
Cable length	8500 mm
DB drawing No.	3 Ebgw 01.67
DB material No.	237 125

## Safety Equipment for electric Railways

## Kit for Overhead Lines

## Earthing Devices

## Kit for Overhead Contact Lines (profile-free\*\*)

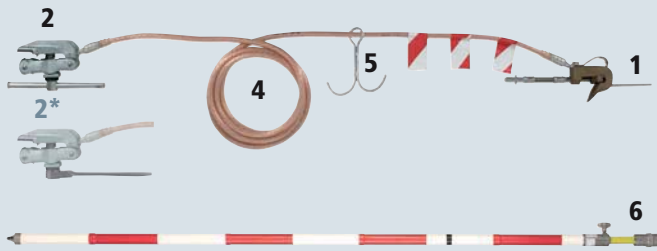

Kit includes:		
Type	Part No.	No.
ESTC SQL RW 5000	1x 769 502	6
EKV K H 50 12000	1x 751 121	1+2+4+5
EKV R H 50 12000	- 751 122	1+2*+4+5

\* Version with ratchet is available on request

Telescopic earthing stick with adjusting ring (max. 5 m long), single-pole earthing and short-circuiting device with suspension hook (tommy bar)

Type	BEV OL PF K
Part No.	750 211
Cable cross-section	50 mm <sup>2</sup>
Cable length	12000 mm
DB drawing No.	3 Ebgw 01.51
DB material No.	237 118

## Kit for Overhead Contact Lines (profile-free\*\*)

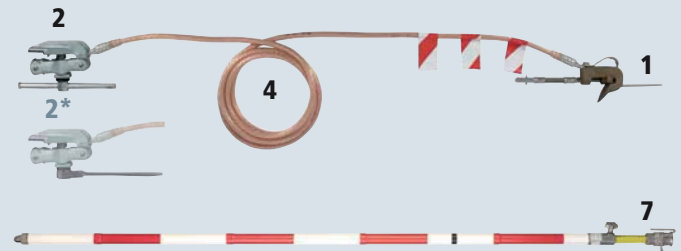

Kit includes:		
Type	Part No.	No.
ESTC SQL H RW 5000	1x 769 508	7
EKV K 50 12000	1x 751 126	1+2+4
EKV R 50 12000	- 751 127	1+2*+4

\* Version with ratchet is available on request

Telescopic earthing stick with cable entry and suspension hook (max. 5 m long), single-pole earthing and short-circuiting device (tommy bar)

Type	BEV OL PF V2 K
Part No.	750 214
Cable cross-section	50 mm <sup>2</sup>
Cable length	12000 mm
DB drawing No.	3 Ebgw 01.51
DB material No.	237 115

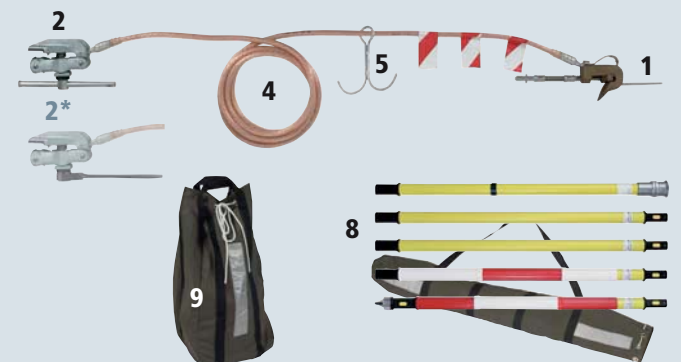
Kit for Overhead Contact Lines for Transport in  
Motor Vehicles (profile-free\*\*)

Kit includes:		
Type	Part No.	No.
EST SQL RW 4915 TA	2x 769 506	8
EKV K H 50 12000	2x 751 121	1+2+4+5
EKV R H 50 12000	- 751 122	1+2*+4+5
STT 55 27 30	1x 785 111	9

\* Version with ratchet is available on request

For technical emergency service and emergency management

Telescopic earthing stick kit consisting of six elements, pluggable (max. 5 m long), (canvas bag (Part No. 769 509) included), single-pole earthing and short-circuiting device (tommy bar), canvas bag

Type	BEV OL PF PKW K
Part No.	750 200
Cable cross-section	50 mm <sup>2</sup>
Cable length	12000 mm
DB drawing No.	3 Ebgw 01.67

\*\* ) Profile-free earthing means that the earthing cable can be suspended on the tower thus allowing for limited diesel locomotive operation.

## Kit for Towers

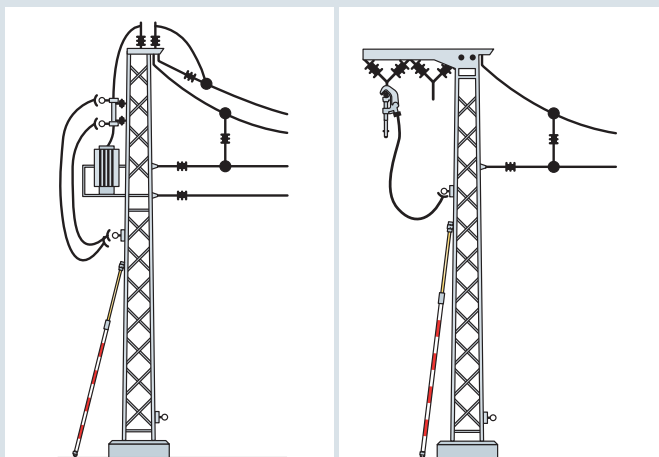

Kit includes:			
Pos. No.	Part No.	Pos. No.	Part No.
1	773 251	4	751 040
2	784 352	5	769 352
3	774 251		

### General Information:

Standard EN/IEC 61230 (DIN VDE 0683 Part 100)

## Kit for Transformers at Overhead Contact Line Towers

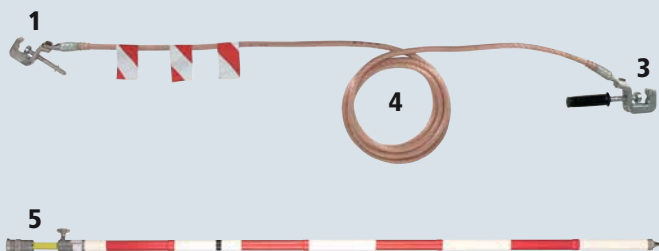

### For earthing at fuse carriers

Telescopic earthing stick with adjusting ring (max. 3.5 m long),

single-pole earthing and short-circuiting device with universal clamp, T pin shaft and handle

Kit includes:		
Type	Part No.	No.
ESTC SQL RW 3500	1x 769 352	5
EKV UK 50 4000	2x 750 041	1+3+4

Type	BEV US OL ST
Part No.	750 212
Cable cross-section	50 mm <sup>2</sup>
Cable length	4000 mm
DB drawing No.	3 Ebgw 01.57
DB material No.	237 121

## Kit for Supply Lines, Line Feeders, Bypass Lines and other Types of Lines

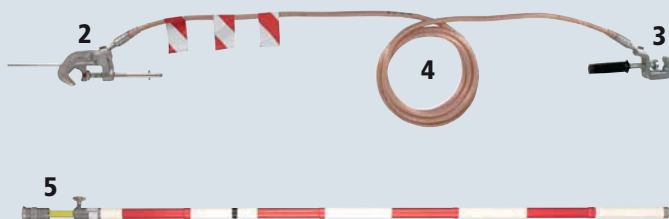

### For earthing the supply line and traction current lines

Telescopic earthing stick with adjusting ring (max. 3.5 m long), single-pole earthing and short-circuiting device with conductor clamp and universal clamp with handle

Kit includes:		
Type	Part No.	No.
ESTC SQL RW 3500	1x 769 352	5
EKV LK 50 4000	1x 750 042	2+3+4

Type	BEV SVUL
Part No.	750 213
Cable cross-section	50 mm <sup>2</sup>
Cable length	4000 mm
DB drawing No.	3 Ebgw 01.57
DB material No.	237 119

## Earthing Device for Towers or Railway Tracks

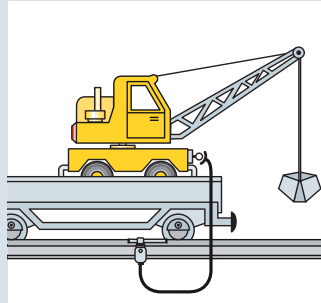
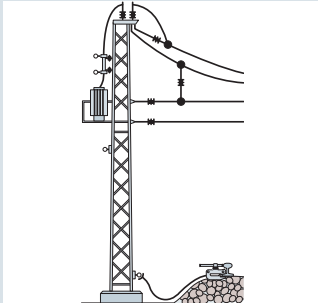

Application 1:

**Earthing the supply line**

Single-pole earthing and short-circuiting device (50 mm<sup>2</sup>), 8.5 m long, with universal clamp with handle and clamp for railway tracks (tommy bar)

Application 2:

**Equipment on maintenance vehicles, earthed track**

Single-pole earthing and short-circuiting device (50 mm<sup>2</sup>), 8.5 m long, with universal clamp with handle and clamp for railway tracks (tommy bar) (clamp for railway tracks with ratchet available on request)

Type	BEV MF SE K
Part No.	751 191
Cable cross-section	50 mm <sup>2</sup>
Cable length	8500 mm
DB drawing No	3 Ebgw 01.56

## Earthing Device for dedicated Busbars

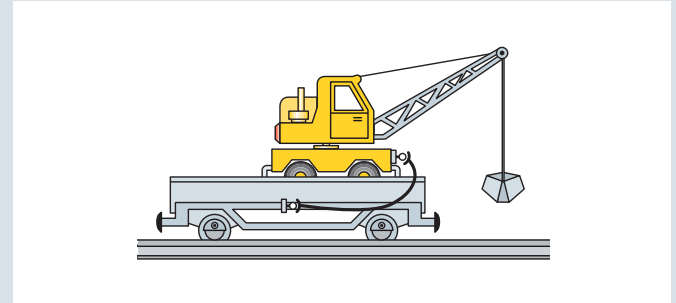
**Equipment on maintenance vehicles, earthed track**

Single-pole earthing and short-circuiting device with two universal clamps with handle

Type	BEV MF LTE
Part No.	751 192
Cable cross-section	50 mm <sup>2</sup>
Cable length	8500 mm
DB drawing No	3 Ebgw 01.56

Single-pole earthing and short-circuiting device with universal clamp with handle and clamp for railway tracks (tommy bar) (clamp for railway tracks with ratchet is available on request)

**Application 1: Equipment on maintenance vehicles**

Equipment on maintenance vehicles, unearthed track (construction site)\*

**Application 2: Equipment or vehicles**

Equipment or vehicles on or in close proximity to the track, unearthed track (construction site)\*, on-track crane

**Application 3: Off-track vehicle**

Off-track vehicle

\* In case of single-track segments, the non-existing adjacent track is replaced by an earthing cable. A universal clamp with handle is to be used instead of a clamp for railway tracks.

Type	BEV BM HZ BDW K
Part No.	751 193
Cable cross-section	50 mm <sup>2</sup>
Cable length	12000 mm
DB drawing No.	3 Ebgw 01.56
DB material No.	237 120

## Earthing Device for adjacent Tracks

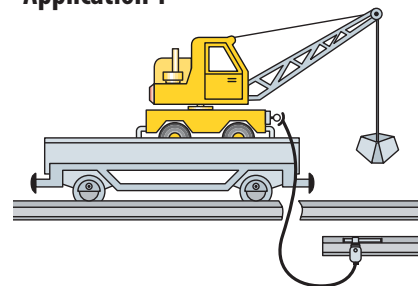
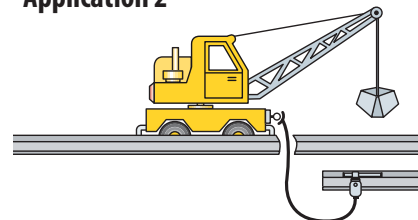
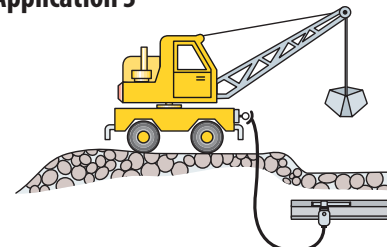
**Application 1****Application 2****Application 3**



## Kit for electric Point and Train Pre-Heating Systems

Safety Equipment for electric Railways

Earthing Devices

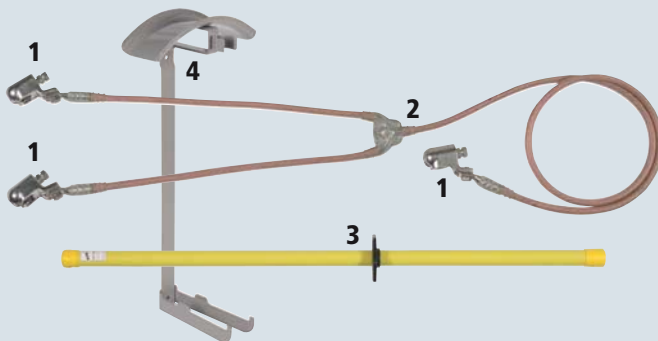
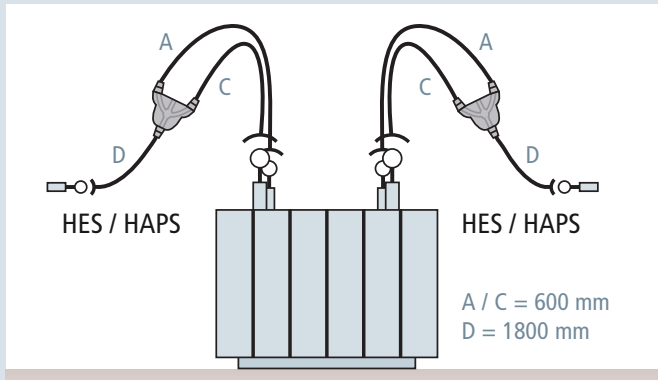

Kit includes:			
Pos. No.	Part No.	Pos. No.	Part No.
1	772 320	3	761 015
2	750 202	4	700 000

### General Information:

Standard EN/IEC 61230 (DIN VDE 0683 Part 100)

For the initial equipment of a transformer of electric point and train pre-heating systems

Kit includes:		
Type	Part No.	No.
ES SK 1500	1x 761 015	3
EKV2 50 KKH 600 1800	2x 751 150	1 (3x)+2
HV EKV ES30	1x 700 000	4

Type	BEV WHA ZVA
Part No.	750 215
DB drawing No.	3 Ebgw 01.70
DB material No.	742 402

For voltage detectors for electric point heating systems, please refer to the PHE voltage detector chapter.

## Earthing and Short-Circuiting Devices

### General Information:

Standard EN/IEC 61230 (DIN VDE 0683 Part 100) and IEC 61138

### Single-pole EaS Device

#### Earth Clamp for Overhead Contact Lines and Clamp for Railway Tracks with Tommy Bar



Phase cable end: Earth clamp for overhead contact lines, clamping range  $\varnothing$ 4–15 mm

Earth cable end: Clamp for railway tracks with tommy bar

Type	EKV K 50 8500	EKV K 50 12000	EKV K H 50 12000
Part No.	751 086	751 126	751 121
Cable cross-section	50 mm <sup>2</sup>	50 mm <sup>2</sup>	50 mm <sup>2</sup>
Cable length	8500 mm	12000 mm	12000 mm
DB drawing No.	3 Ebgw 01.51/67	3 Ebgw 01.51/67	3 Ebgw 01.51/67
Hook	—	—	✓ —

### Single-pole EaS Device

#### Earth Clamp for Overhead Contact Lines and Clamp for Railway Tracks with Ratchet



Phase cable end: Earth clamp for overhead contact lines, clamping range  $\varnothing$ 4–15 mm

Earth cable end: Clamp for railway tracks with ratchet

Type	EKV R 50 8500	EKV R 50 12000	EKV R H 50 12000
Part No.	751 087	751 127	751 122
Cable cross-section	50 mm <sup>2</sup>	50 mm <sup>2</sup>	50 mm <sup>2</sup>
Cable length	8500 mm	12000 mm	12000 mm
DB drawing No.	3 Ebgw 01.51/67	3 Ebgw 01.51/67	3 Ebgw 01.51/67
Hook	—	—	✓ —

## Safety Equipment for electric Railways

## Earthing and Short-Circuiting Devices

## Earthing Devices

## Single-pole EaS Device

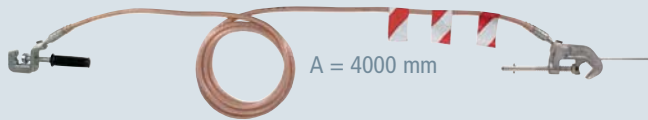
Conductor Clamp and Universal Earth Clamp  
with Handle

Phase cable end: Conductor clamp, T pin shaft  
Earth cable end: Universal clamp, plastic handle

Type	EKV LK 50 4000
Part No.	750 042
Cable cross-section	50 mm <sup>2</sup>
Cable length	4000 mm
DB drawing No.	3 Ebgw 01.57

## Single-pole EaS Device

## Universal Earth Clamps with T Pin and Handle

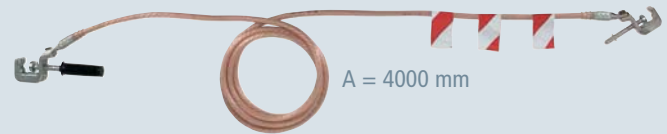

Phase cable end: Universal clamp, T pin shaft  
Earth cable end: Universal clamp, plastic handle

Type	EKV UK 50 4000
Part No.	750 041
Cable cross-section	50 mm <sup>2</sup>
Cable length	4000 mm
DB drawing No.	3 Ebgw 01.57

## Single-pole EaS Device

## Universal Earth Clamp and Clamp for Railway Tracks

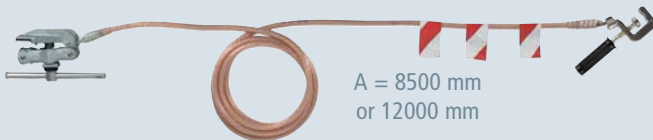

Phase cable end: Universal clamp, plastic handle  
Earth cable end: Clamp for railway tracks with tommy bar

Type	BEV MF SE K	BEV BM HZ BDW K
Part No.	751 191	751 193
Cable cross-section	50 mm <sup>2</sup>	50 mm <sup>2</sup>
Cable length	8500 mm	12000 mm
DB drawing No.	3 Ebgw 01.56	3 Ebgw 01.56

Version with ratchet is available on request.

## Single-pole EaS Device

## Two Universal Earth Clamps with Handle



Phase cable end: Universal clamp, plastic handle  
Earth cable end: Universal clamp, plastic handle

Type	BEV MF LTE
Part No.	751 192
Cable cross-section	50 mm <sup>2</sup>
Cable length	8500 mm

## Accessory for Earthing and Short-Circuiting Devices

Single-pole Earthing and Short-Circuiting  
Cable, unequipped

With red and white marking and hole in the terminal lug (Ø10.5 mm), type PK2 cable lug without cut-out

Type	EKS 50 ...	BEV 4M	BEV 8.5M	BEV 12M
Part No.		751 040	751 085	751 120
Cable cross-section	50 mm <sup>2</sup>	50 mm <sup>2</sup>	50 mm <sup>2</sup>	50 mm <sup>2</sup>
Cable length	4000 mm	8500 mm	12000 mm	
DB drawing No.	3 Ebgw 01.57	3 Ebgw 01.51	3 Ebgw 01.51	
DB material No.	157 511	157 512	157 513	

Type	EKS 50 ...	BEV 13M	BEV 14M
Part No.		751 130	751 140
Cable cross-section	50 mm <sup>2</sup>	50 mm <sup>2</sup>	
Cable length	13000 mm	14000 mm	
DB drawing No.	—	—	
DB material No.	—	—	



## Suspension Hook

For (profile-free) suspending of earthing cables on towers

Type	EHH BEV OL
Part No.	740 124
DB drawing No.	3 Ebgw 01.51
DB material No.	778 794



## Two-pole EaS Devices

## Ball Head Caps

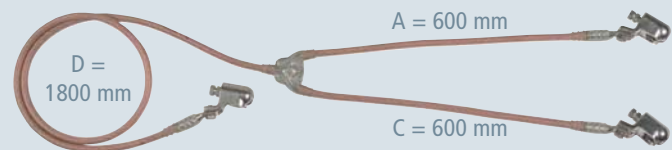

Phase cable end: Two ball head caps (Ø25 mm), hexagon shaft  
Earth cable end: Ball head cap (Ø25 mm), hexagon shaft

Type	EKV2 50 KKH 600 1800
Part No.	751 150
Cable cross-section	50 mm <sup>2</sup>
Cable length	600/1800 mm
DB drawing No.	3 Ebgw 01.70
DB material No.	742 400

## Phase Connecting Elements

Safety Equipment for electric Railways

Earthing Devices



### Conductor Clamp



With contact electrode and threaded T pin shaft according to DIN 48087  
For supply and traction power lines

Type	LK 4 40 TS SQL
Part No.	784 352
Clamping range	Ø4 - 40 mm
DB drawing No.	3 Ebgw 01.65
DB material No.	157 539

### Earth Clamp for Overhead Contact Lines



With contact electrode and flexible threaded T pin shaft according to  
DIN 48087  
For overhead contact lines 80 a.c. to 120 a.c.

Type	FEK 4 15 TS FSQ
Part No.	784 755
Clamping range	Ø4 - 15 mm
DB drawing No.	3 Ebgw 01.54
DB material No.	157 536

## Earthing Devices



## Clamp for Railway Tracks with Tommy Bar



With detachable tommy bar (locking spring)  
For profile-free earthing of track profiles S49, S54, S64 and UIC60

Type	SAK PFE KN
Part No.	792 450
DB drawing No.	3 Ebgw 01.53
DB material No.	157 535

## Clamp for Railway Tracks with Ratchet

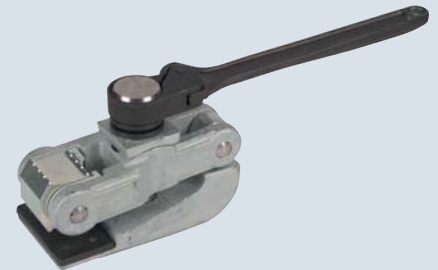

With detachable ratchet  
For profile-free earthing of track profiles S49, S54, S64 and UIC60

Type	SAK PFE RA
Part No.	792 453
DB drawing No.	3 Ebgw 01.53
DB material No.	157 549

## Universal Clamp, T Pin Shaft



T pin according to DIN 48087  
For flat and round conductors up to 30 mm and fixed ball points, ball (Ø25 mm)

Type	UK K25 FL30 SQL
Part No.	773 251
Clamping range	30 mm
DB drawing No.	4 Ebgw 01.59
DB material No.	157 538

## Universal Clamp with plastic Handle



For flat and round conductors up to 30 mm and fixed ball points, ball (Ø25 mm)

Type	UK K25 FL30 HG
Part No.	774 251
Clamping range	30 mm
DB drawing No.	4 Ebgw 01.64
DB material No.	157 537

## Earthing Sticks

Safety Equipment for electric Railways

For threaded T pin shafts (bayonet locking mechanism)

Earthing Devices



### General Information:

Standard	EN/IEC 61230 (DIN VDE 0683 Part 100)
Temperature range	- 25 °C ... + 55 °C

### Telescopic Earthing Stick

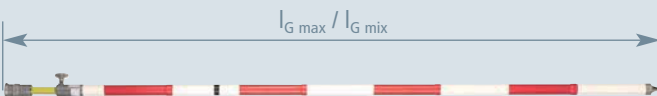

For threaded T pin shafts (bayonet locking mechanism)

Type	ESTC SQL RW 3500	ESTC SQL RW 5000
Part No.	769 352	769 502
Total length ( $l_{G \max} / l_{G \min}$ )	3500 / 1920 mm	5000 / 2670 mm
Max. load on the operating head ( $l_{\max} / l_{\min}$ )	12 / 35 kg	10 / 35 kg
DB drawing No.	3 Ebgw 01.58	3 Ebgw 01.52
DB material No.	157 534	157 533

- For outdoor use
- Robust aluminium cone coupling
- Telescopic stick, gradually adjustable via star handle
- Only suitable for phase screw clamps and clamps with long T pin shaft

### Lockable adjusting ring

The adjusting ring on the cone has the following functions:

- Position "AUF" (= OPEN): Stick can be removed from the clamp after the earthing and short-circuiting device has been connected
- Position "ZU" (= CLOSED): Stick and clamp remain coupled even after the earthing and short-circuiting device has been connected



### Telescopic Earthing Stick with Cable Entry and Hook

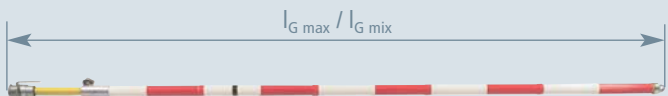

For threaded T pin shafts (bayonet locking mechanism)

The clamp coupling is fitted with an additional cable guide and a hook for securing the earthing cable and earthing stick at the tower (without adjusting ring)

Type	ESTC SQL H RW 5000
Part No.	769 508
Total length ( $l_{G \max} / l_{G \min}$ )	5000 / 2670 mm
Max. load on the operating head ( $l_{\max} / l_{\min}$ )	10 / 35 kg
DB drawing No.	3 Ebgw 01.55
DB material No.	612 142

### Six-part Earthing Stick Kit (for Transport in Motor Vehicles)

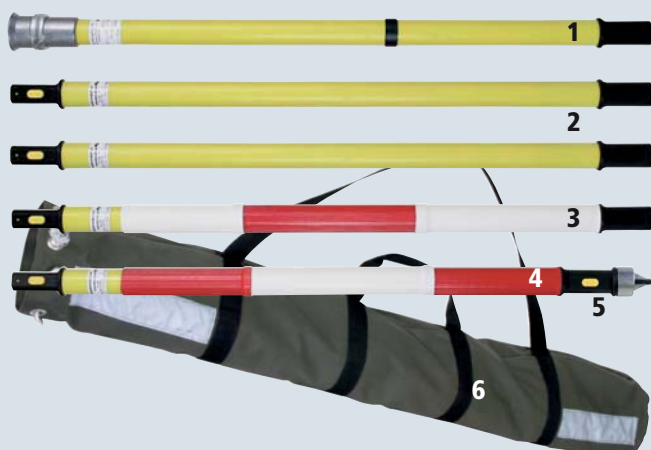

Kit includes:			
Pos. No.	Part No.	Pos. No.	Part No.
1	1x 766 074	4	1x 766 079
2	2x 766 076	5	1x 766 889
3	1x 766 078	6	1x 769 509

For more detailed information on these products, see Accessory chapter

For threaded T pin shafts (bayonet locking mechanism)

Type	EST SQL RW 4915 TA
Part No.	769 506
Total length ( $l_{G \max} / l_{G \min}$ )	4905 / 1045 mm
Max. load on the operating head ( $l_{\max} / l_{\min}$ )	10 / 35 kg
DB drawing No.	3 Ebgw 01.68
DB material No.	157 489



## Earthing Devices

- M12 or M16 threaded pin available in different lengths
- With or without hexagon nut and flat washer
- Suitable for fixing cable lugs or connecting busbars according to DIN 43673 Part 1



Universal clamp mounted on the fixed ball point of a steel tower

## General Information:

Standard	EN/IEC 61230 (DIN VDE 0683 Part 100) and DIN 48088 Part 1
Material (fixed point)	E-Cu/gal Sn
Material (threaded pin)	StSt A2-70
Hexagon nut	DIN 985-M12-8 / gal Zn; DIN 985-M16-8 / gal Zn;
Tightening torque	M12: 80 Nm; M16: 150 Nm

## Straight with threaded Pin and Nut



Ball head (∅25 mm)

Type ...	M16 25 SKM	M12 35 SKM	M16 45 SKM
Part No.	755 626	755 627	755 646
Fixed ball point ∅	25 mm	25 mm	25 mm
Dimensions	M16 x 25 mm	M12 x 35 mm	M16 x 45 mm
DB drawing No.	3 Ebgw 01.63	3 Ebgw 01.63	3 Ebgw 01.63
DB material No.	157 541	622 014	157 542

## Straight with threaded Pin



Ball head (∅25 mm)

Type	KFP 25 M16 25
Part No.	755 636
Fixed ball point ∅	25 mm
Dimensions	M16 x 25 mm
DB drawing No.	3 Ebgw 01.63
DB material No.	609 426

## Earth Connecting Plate and Terminal Lug

Safety Equipment for electric Railways

Earthing Devices

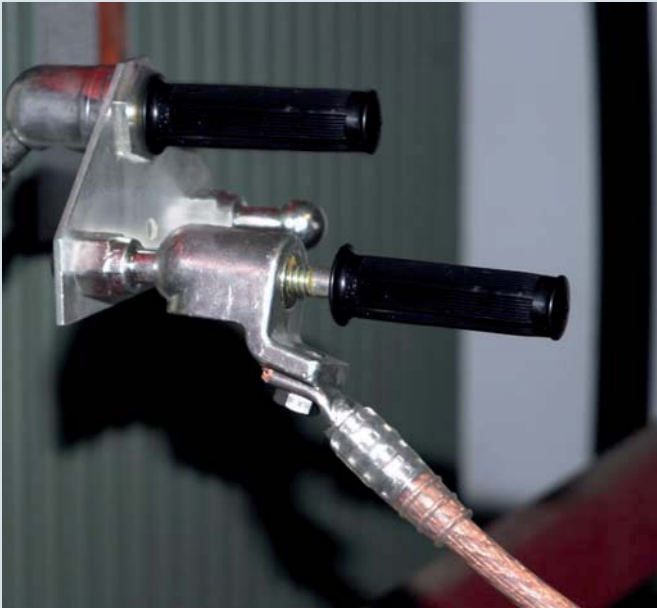

Ball head cap with handle mounted on an earth connecting plate

- Earth connecting plate with adjustable ball head cap and handle
- Terminal lug with one or two fixed ball point(s) (Ø25 mm)
- For connecting single-pole earthing and short-circuiting devices to transformers of overhead contact line towers or to fuse holders

### Earth Connecting Plate



With adjustable ball head cap (Ø25 mm) and plastic handle  
For combination of two single-pole earthing and short-circuiting devices and connection to a fixed ball point (Ø25 mm)

Type	EAP 2 25 KKH HG
Part No.	728 501
Fixed ball point Ø	25 mm
Dimensions	170 x 110 x 4 mm
DB drawing No.	3 Ebgw 01.66
DB material No.	157 540

### General Information:

Standard	EN/IEC 61230 (DIN VDE 0683 Part 100) and DIN 48088 Part 1
Material (earth connection plate)	Cu / gal Sn
Material (connection lug)	4 mm: Cu / gal Sn; 6 mm: St / tZn
Material (fixed point)	E-Cu/gal Sn
Material (threaded bolt)	StSt A2-70

### Terminal Lug with one Fixed Ball Point



With two holes  
To be connected to a fuse holder

Type	EAP 25 SIT US OL
Part No.	728 503
Fixed ball point Ø	25 mm
Dimensions	155 x 30 x 4 mm
DB drawing No.	4 Ebgw 01.60
DB material No.	157 545

### Terminal Lug with two Fixed Ball Points



With two holes  
To be connected to towers

Type	EAP 2 25 MA US OL
Part No.	728 502
Fixed ball point Ø	25 mm
Dimensions	140 x 40 x 6 mm
DB drawing No.	3 Ebgw 01.61
DB material No.	157 548

Safety Equipment for electric Railways **Insulating Stick Kit for Cleaning the Windscreens of electric Locomotives**

## Further Equipment

- For use in wet weather conditions
- Insulating stick kit for cleaning the wind-screens of electric locomotives
- Protection against accidental contact with live parts (e.g. overhead contact lines)
- Adjustable inclination angle of the operating head

## Kit includes:

Pos. No.	Part No.	Pos. No.	Part No.
1	766 048	3	766 056
2	766 055	4	766 057

For more detailed information on these products, see Accessory chapter

## Note:

In accordance with EN/IEC 61243-1 (DIN VDE 0682 Part 411) IS 25 ZK 2885 insulating sticks and AD ZK 25 200 adapters can be used for nominal voltages up to 7.5 kV d.c. and 25 kV a.c. even in wet weather conditions. The cleaning agent must not exceed the maximum conductivity of 1000  $\mu\text{S} / \text{cm}$ .

Due to the risk of bridging, water and cleaning agents must not be used to clean live parts of installations.



Nominal voltages up to 7.5 kV / d.c. and 25 kV / a.c.



Insulating stick kit used for cleaning the windscreen of an electric locomotive

## General Information:

Standard	Wet test in accordance with EN/IEC 61243-1 (DIN VDE 0682 Part 411)
Material (insulating tube)	Glass-fibre reinforced polyester tube
End fitting	Non-slip plastic cap

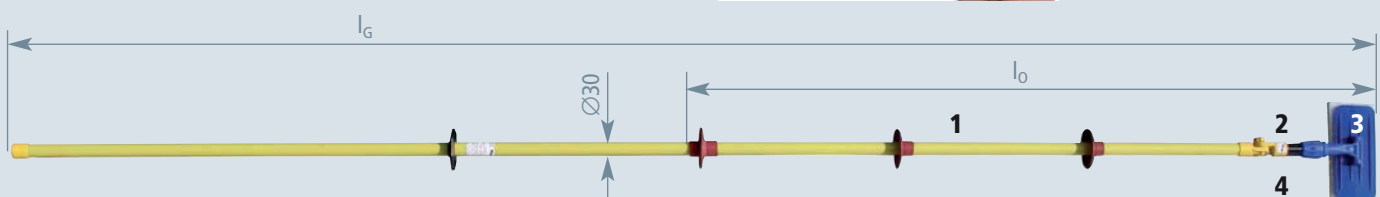

Type	IS 25 ZK RK 3160
Part No.	766 340
Nominal voltage $U_N$ a.c.	Up to 25 kV
Nominal voltage $U_N$ d.c.	Up to 7.5 kV
Total length ( $l_G$ )	3160 mm
Insertion depth ( $l_0$ )	1630 mm

## SDS

## Safety Equipment for electric Railways

## Voltage limiting device

## Further Equipment



DIN EN 50122-1 describes the use of voltage limiting devices for d.c. and a.c. traction systems for so-called "open traction system earthing" of conductive components of overhead contact lines and current collectors. In order to prevent the occurrence of hazardous surges between the insulated tracks or track sections of electric railways and earthed parts of the installation, voltage limiting devices (SDS ...) are used.

Their function is to permanently connect parts of the installation in the overhead contact line and current collector areas to the return conductor as soon as the threshold voltage is exceeded.

- Electrical isolation of insulated track sections and earthed parts of installations
- Safe equipotential bonding in case of a short circuit or earth fault at the overhead contact line due to high-current-resistant welding of the electrodes
- Discharge of lightning surges without formation of short circuits due to lightning-resistant SDS ... voltage limiting device
- Short-circuit withstand capability up to 25 kA<sub>rms</sub> / 100 ms; 36 kA<sub>rms</sub> / 75 ms

Cylindrical SDS spark gap unit for use with rail adapter Siemens No. 8WL6503-xx

In case of atmospheric overvoltages, the lightning-resistant SDS ... voltage limiting device is capable of returning to its initial state after discharging the impulse current. Only if the specified lightning current load is exceeded, a permanent short-circuit is initiated by heavy-current-resistant welding of the electrodes and the fuse link has to be replaced.

The SDS voltage limiting device consists of a spark gap unit and the respective connecting kit for direct connection to the rail or overhead contact line tower.





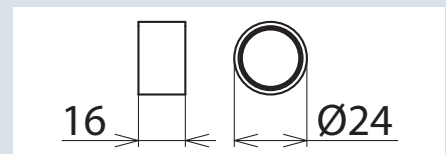
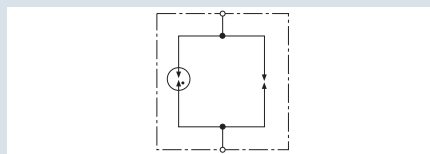



The spark gap unit of type SDS 1 (Part No. 923 110) developed by DEHN + SÖHNE has also been approved by the German Federal Railway Authority (EBA).

## SDS ...

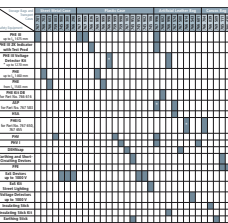

Type	SDS 1	SDS 2	SDS 3	SDS 4	SDS 5
Part No.	923 110	923 117	923 116	923 118	923 119
Power frequency sparkover voltage (U <sub>av</sub> )	≤ 940 V	—	—	—	—
d.c. sparkover voltage (U <sub>ag</sub> )	600 V +/- 20 %	350 V +/- 20 %	550 V	230 V +/- 20 %	120 V +/- 20 %
Impulse sparkover voltage	≤ 1400 V (1 kV/μs)	≤ 900 V (1 kV/μs)	≤ 1000 V (1 kV/μs)	≤ 650 V (1 kV/μs)	≤ 600 V (1 kV/μs)
Self-extinguishing capability	300 A / 65 V	—	—	—	—
Lightning current discharge capacity (10/350 μs) 0,1x / 0,5x / 1x	5 kA	2 kA	2.5 kA	2.5 kA	2 kA
Lightning current withstand capability (10/350 μs)	25 kA	25 kA	25 kA	25 kA	25 kA
Impulse current discharge capacity (8/20 μs) 0,1x / 0,5x / 1x	—	—	—	20 kA	20 kA
Safe short-circuit due to welding of the electrodes for alternating currents @ 100 ms	≥ 1.5 kA / 1000 V / 100 ms	—	—	—	—
Safe short-circuit due to welding of the electrodes for alternating currents @ 30 ms	≥ 2.5 kA / 1000 V / 30 ms	—	—	—	—
Safe short-circuit due to welding of the electrodes for direct currents	≥ 750 A / 250 ms	≥ 600 A / 250 ms	—	≥ 600 A / 250 ms	≥ 600 A / 250 ms
Short-circuit withstand capability	25 kA <sub>rms</sub> / 100 ms; 36 kA <sub>rms</sub> / 75 ms	25 kA <sub>rms</sub> / 100 ms; 36 kA <sub>rms</sub> / 75 ms	25 kA <sub>rms</sub> / 100 ms; —	25 kA <sub>rms</sub> / 100 ms; 36 kA <sub>rms</sub> / 75 ms	25 kA <sub>rms</sub> / 100 ms; 36 kA <sub>rms</sub> / 75 ms
Long-term current	1 kA <sub>rms</sub> for t ≤ 120 s	1 kA <sub>rms</sub> for t ≤ 120 s	—	1 kA <sub>rms</sub> for t ≤ 120 s	1 kA <sub>rms</sub> for t ≤ 120 s
Leakage current (I <sub>l</sub> )	< 1 μA for 100 V dc	< 1 μA for 100 V dc	—	< 1 μA for 100 V dc	< 1 μA for 100 V dc
Operating temperature range (T <sub>ij</sub> )	-40 °C...+80 °C	-40 °C...+80 °C	-40 °C...+80 °C	-40 °C...+80 °C	-40 °C...+80 °C
For mounting on	voltage breakdown protectors/SIEMENS rail adapters No. 8WL6503-xx				
Tightening torque of the fuse link in the busbar adapter	15 Nm	15 Nm	15 Nm	15 Nm	15 Nm
Approvals	EBA	—	—	—	—
DB Drawing No.	4 Ebs 15.13.20 Blatt 2	—	—	—	—

## Storage Bags and Transport Cases

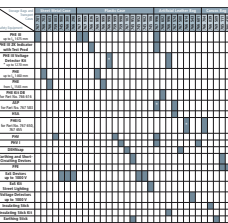
Case / Bag	Design	Page									
Sheet Metal Case	Hammer-tone finished With retaining springs With foam padding	188	 								
Plastic Case	With foam padding	189	 								
Artificial Leather Bag	With carrier handle With shoulder strap	191									
Canvas Bag	With carrier handle	192			With two separate internal pockets			Easy Choice		193	
	With two separate internal pockets										
Easy Choice		193									



## Sheet Metal Case

Accessory

Storage Bags and Transport Cases

## Sheet Metal Case for PHE III



Hammer-tone finished with foam padding

Type	SKL 95 21 10
Part No.	767 701
Dimensions	950 x 210 x 100 mm
Colour	Blue

## Sheet Metal Case for PHE



Hammer-tone finished with retaining springs

Type	SKL 92 16 10	SKL 116 16 10
Part No.	766 703	766 603
Dimensions	920 x 160 x 100 mm	1150 x 160 x 100 mm
Colour	Blue	Blue

## Sheet Metal Case for PHV



Hammer-finished with foam padding

Type	SKL 95 21 10 V2
Part No.	759 003
Dimensions	950 x 210 x 100 mm
Colour	Blue

## Sheet Metal Case for Earthing and Short-Circuiting Device VI – Kit



With foam padding

Type	SBKL EKS VI KVS
Part No.	745 900
Dimensions	440 x 330 x 100 mm
Colour	Blue

## Sheet Metal Case for Earthing and Short-Circuiting Device TI – Kit I



Type	SBKL EKS TI KVS
Part No.	766 300
Dimensions	380 x 260 x 80 mm
Colour	Blue

## Sheet Metal Case for Earthing and Short-Circuiting Device TI – Kit II



With foam padding

Type	SBKL EKS TI KVS 2F
Part No.	766 298
Dimensions	440 x 330 x 66 mm
Colour	Blue

## Accessory

## Plastic Case

## Storage Bags and Transport Cases

## Plastic Case for PHE III



With foam padding

Type	KKL PHE3	KKL PHE3 L
Part No.	767 997	767 999
Dimensions	930 x 215 x 140 mm	1270 x 215 x 140 mm
Colour	Black	Black

## Plastic Case for PHE III Indicator with Test Prod



With foam padding

Type	KKL PK PHE3 L
Part No.	766 036
Dimensions	395 x 295 x 105 mm
Colour	Grey

## Plastic Case for PHE



With foam padding

Type	KKL PHE	KKL PHE L
Part No.	766 997	766 999
Dimensions	930 x 215 x 140 mm	1270 x 215 x 140 mm
Colour	Black	Black

## Plastic Case for PHE III Kit



With foam padding

Type	KKL PHE3 60 110
Part No.	766 998
Dimensions	1270 x 215 x 140 mm
Colour	Black

## Plastic Case for PHV



With foam padding

Type	KKL PHV
Part No.	759 999
Dimensions	930 x 215 x 140 mm
Colour	Black

## Plastic Case for PHV I



With foam padding

Type	KKL PHV1
Part No.	759 998
Dimensions	1270 x 215 x 140 mm
Colour	Black

## Plastic Case

Accessory

## Storage Bags and Transport Cases

## Plastic Case for DEHNcap



With foam padding

Type	KKL DCA
Part No.	767 107
Dimensions	395 x 295 x 105 mm
Colour	Grey

## Plastic Case for Earthing Stick



With retaining springs for two-part earthing stick

Type	KK 56 41 17 EK HK
Part No.	745 953
Dimensions	565 x 410 x 170 mm
Colour	Black

## Plastic Case for Earthing and Short-Circuiting Device VI/TI



With foam padding and velcro fastener

Type	KK 56 41 17 EK VI TI
Part No.	745 952
Dimensions	565 x 410 x 170 mm
Colour	Black

## Plastic Case for Earthing and Short-Circuiting Device VI – Kit



With foam padding

Type	KKL EKS VI KVS
Part No.	745 902
Dimensions	445 x 345 x 100 mm
Colour	Black

## Plastic Case for EKV ÜGK



With foam padding

Type	KKL EKV ÜGK MB
Part No.	745 106
Dimensions	395 x 295 x 105 mm
Colour	Grey

## Accessory

## Artificial Leather Bag

## Storage Bags and Transport Cases

## Artificial Leather Bag for PHE III, PHE, ASP, PHV and PHV I

With shoulder strap and carrier handle



Type	KLT 101 30 10
Part No.	767 996
Dimensions	1010 x 300 x 100 mm
Colour	Black

## Artificial Leather Bag for PHE

With carrier handle



Type	KLT 247 10 22
Part No.	766 602
Dimensions	2470 x 220 x 100 mm
Colour	Black
DB Drawing No.	3 Ebgw 02.51

## Artificial Leather Bag

With zip and carrier handle



Type	KLT 133 34 10
Part No.	766 996
Dimensions	1330 x 345 x 100 mm
Colour	Black

## Artificial Leather Bag for ASP and HSA

With zip and carrier handle



Type	KLT 104 9
Part No.	767 574
Dimensions	Ø90 x 1040 mm
Colour	Black

## Artificial Leather Bag for DEHNCap/PC

With carrier handle



Type	KLT 23 16 4
Part No.	767 500
Dimensions	235 x 160 x 40 mm
Colour	Black

## Artificial Leather Bag for PHE/G

With carrier handle



Type	KLT 160 17
Part No.	766 614
Dimensions	Ø170 x 1600 mm
Colour	Black

## Artificial Leather Bag for SPN

For SPN voltage detectors (basic device with extension prods)



Type	AT SPN II
Part No.	766 543
Dimensions	535 x 160 mm
Colour	Black

## Artificial Leather Bag for PHE, PHV I

With carrier handle



Type	KLT 121 25 16
Part No.	766 601
Dimensions	1200 x 250 x 160 mm
Colour	Black

## Canvas Bag

Accessory

### Storage Bags and Transport Cases

#### Canvas Bag for PHE

With carrier handle



Type	STT 120 30 15
Part No.	766 704
Dimensions	1220 x 390 x 150 mm
Colour	Olive

#### Canvas Bag for Earthing and Short-Circuiting Device and PPE

With two separate internal pockets and carrier handle



Type	STT 55 27 30
Part No.	785 111
Dimensions	550 x 255 x 300 mm
Colour	Olive
DB Drawing No.	3 Ebgw 01.67

#### Canvas Bag for ISMTC

With carrier handle



Type	STT 180 20
Part No.	766 039
Dimensions	∅200 x 1800 mm
Colour	Olive

#### Storage Bag



Type	AT PSA NS
Part No.	785 425
Dimensions	∅300, 500 mm
Colour	Blue

#### Canvas Bag for Earthing Stick



For six-part earthing stick (for transport in motor vehicles), with carrier handle

Type	STT 110 15
Part No.	769 509
Dimensions	∅150 x 1100 mm
Colour	Olive
DB Drawing No.	3 Ebgw 01.67































## Accessory and Kit Parts

## Selection Guide

Devices	Application	Page		
Electrodes	With M8 thread, to be screwed on test prods	196		
Test Prods for PHE III and PHE Voltage Detectors	Safe contact with the parts of the installation to be tested	197		
Probes	With M8 thread, to be screwed on test electrodes For switchgear installations with limited access	198		
Indicators	With threaded pin or universal gear coupling	200		
Operating Heads	With plug-in coupling	201		
Insulating Sticks	With plug-in coupling	202		
Insulating Elements		203		
Handles and Extensions	With plug-in coupling	204		
End Fittings	For plug-in couplings	205		
Adapters				
Storage Devices	For earthing and short-circuiting devices and sticks, fuse tongs	206		
Installation Devices		208		

## Electrodes

Accessory and Kit Parts



- Safe contact with the part of the installation to be tested
- With M8 thread, to be screwed on the test prods of PHE III and PHE voltage detectors as well as PHV phase comparators

## Onion-shaped Electrode



Type	EL M8 SZ PHE PHV
Part No.	766 913
Nominal voltage ( $U_N$ )	From 3 kV
Material	Brass/gal CuSn

## Pin-shaped Electrode



Type	EL M8 S PHE PHV
Part No.	766 925
Nominal voltage ( $U_N$ )	From 3 kV
Material	StSt

## Hook-shaped Electrode



Type	EL M8 H PHE
Part No.	766 923
Nominal voltage ( $U_N$ )	For overhead lines only
Material	Steel/gal Zn

## Fork-shaped Electrode



Type	EL M8 G PHE
Part No.	766 924
Nominal voltage ( $U_N$ )	For overhead lines only
Material	StSt

## V-shaped Electrode



Type	EL M8 V PHE PHV
Part No.	766 927
Nominal voltage ( $U_N$ )	From 3 kV
Material	Cu/gal Sn

## Eaton Holec Magnefix Electrode



For Eaton Holec Magnefix switchgear installations of type MA, MD4, MF, MG, MY

Type	EL M8 MAG PHE PHV
Part No.	766 915
Nominal voltage ( $U_N$ )	3 ... 15 kV
Material	Brass/gal CuSn, PVC

## Accessory and Kit Parts

## Test Prods for PHE III and PHE Voltage Detectors

- Test prod with integrated test electrode allows safe contact with the part of the installation to be tested

## General Information:

Colour	Grey or yellow
Diameter	Ø20 mm
Material (test electrode)	Copper alloy/gal Sn
Material (test prod)	Glass-fibre reinforced epoxy resin



## Test Prod for Switchgear Installations and Overhead Lines

Category "S"



Type	S60 PS PHE 285	S61 PS PHE 435	S62 PS PHE 620	S63 PS PHE 780	S64 PS PHE 880
Part No.	767 760	767 761	767 762	767 763	767 764
Total length ( $l_G$ )	320 mm	470 mm	655 mm	815 mm	915 mm
Insertion depth ( $l_o$ )	285 mm	435 mm	620 mm	780 mm	880 mm

Type	S66 PS PHE 880
Part No.	767 771
Total length ( $l_G$ )	915 mm
Insertion depth ( $l_o$ )	880 mm

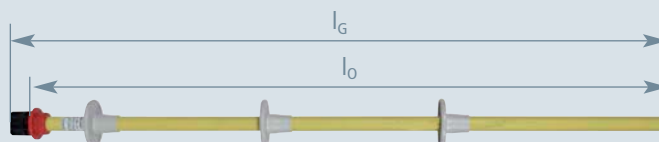
Test Prod for PHE Voltage Detectors  
for Overhead Lines

Type	PS PHE 15 16.7
Part No.	766 619
Total length ( $l_G$ )	1060 mm
DB drawing No.	3 Ebgw 02.53

## Test Prod for Overhead Lines

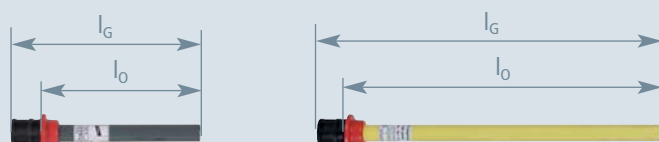

Category "L"

Type	L71 PS PHE 185	L72 PS PHE 405
Part No.	767 766	767 772
Total length ( $l_G$ )	220 mm	415 mm
Insertion depth ( $l_o$ )	185 mm	380 mm
Colour	Grey	Yellow

## Test Prod for Mipak Switchgear Installations



Category "S"

for PHE III voltage detectors (Part No. 767 731/S and 767 750/S)

Type	S65 M PS PHE 905
Part No.	767 767
Total length ( $l_G$ )	940 mm
Insertion depth ( $l_o$ )	905 mm

## Test Prod for Siemens 8CK Switchgear Installations

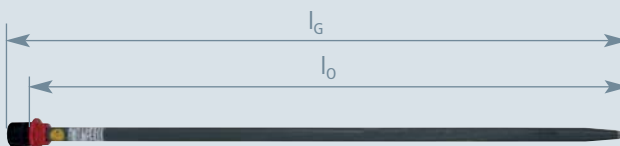

Category "S"

for PHE III voltage detectors (Part No. 767 721, 767951, 767 722, 767 740 and 767940)

Type	S63 PS PHE 8CK
Part No.	767 768
Total length ( $l_G$ )	880 mm
Insertion depth ( $l_o$ )	845 mm

Other types are available on request.



**Probes**

Accessory and Kit Parts



- Safe contact with the part of the installation to be tested
- With M8 thread, to be screwed on test electrodes of PHE and PHE III voltage detectors
- For switchgear installations with limited access
- Available in different lengths and angles



**General Information:**

Use Not suitable for use in wet weather conditions

**Straight Test Probe**

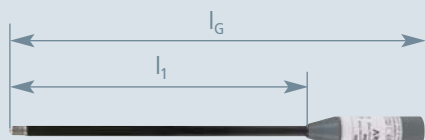

For switchgear installations with limited access (e.g. Calor Emag/Isopond and Krone/KES)

Type	PSO M8 PHE
Part No.	766 916
Nominal voltage (U <sub>N</sub> )	3 ... 24 kV
Diameter	11 mm
Total length (l <sub>G</sub> )	420 mm
Length (l <sub>1</sub> )	300 mm

**Straight Test Probe, 800 mm**

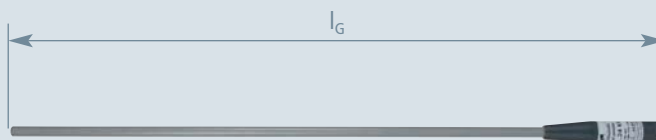

For transformer stations and switchgear installations that require a greater insertion depth

Suitable for use in wet weather conditions



Type	PSO M8 PHE L800
Part No.	766 960
Nominal voltage (U <sub>N</sub> )	3 ... 24 kV
Diameter	14 mm
Total length (l <sub>G</sub> )	890 mm

## 25° angled Test Probe

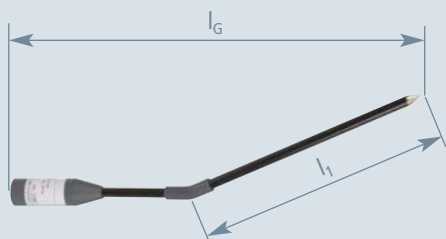

For switchgear installations with limited access

Type	PSO M8 W25 PHE
Part No.	766 940
Nominal voltage ( $U_N$ )	3 ... 24 kV
Diameter	11 mm
Total length ( $l_G$ )	450 mm
Length ( $l_1$ )	280 mm

## 45° angled Test Probe

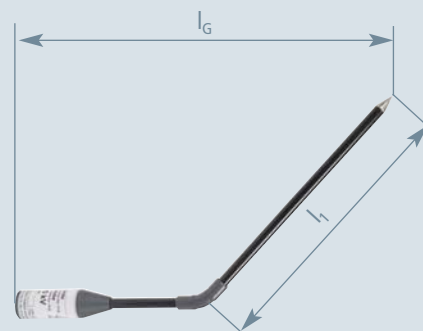

For switchgear installations with limited access

Type	PSO M8 W45 PHE
Part No.	766 941
Nominal voltage ( $U_N$ )	3 ... 24 kV
Diameter	11 mm
Total length ( $l_G$ )	395 mm
Length ( $l_1$ )	280 mm

## 90° angled Test Probe



For switchgear installations with limited access and remotely situated contacts

Type	PSO M8 W90 PHE
Part No.	766 950
Nominal voltage ( $U_N$ )	3 ... 36 kV
Diameter	20 mm
Total length ( $l_G$ )	215 mm
Length ( $l_1$ )	370 mm

Test probes for other special switchgear installations are available on request.

## Field Sensor



Electric field sensors for ASP non-contact voltage detectors

Suitable for use in wet weather conditions



Type	EFS L 127	EFS S 167
Part No.	767 576	767 577
Category	L	S
Total length ( $l_G$ )	127 mm	167 mm
Material	Plastic	Plastic
Colour	Black	Black

## Indicators

Accessory and Kit Parts

## Indicator with M12 threaded Pin

Typ PHE3 ...	A 30 60 S	A 30 60 L	A 60 110 S
Part No.	767 972	767 974	767 734
Nominal voltage (U <sub>N</sub> )	30 ... 60 kV	30 ... 60 kV	60 ... 110 kV
Category	S	L	S
Total length (l <sub>G</sub> )	190 mm	190 mm	190 mm

Type	PHE3 A 60 110 L	PHE3 A 60 110 S IT
Part No.	767 726	767 963
Nominal voltage (U <sub>N</sub> )	60 ... 110 kV	60 ... 110 kV
Category	L	S
Total length (l <sub>G</sub> )	190 mm	190 mm

Type	PHE3 A 60 132 SL	PHE3 A 110 132 S
Part No.	767 732	767 129
Nominal voltage (U <sub>N</sub> )	60 ... 132 kV	110 ... 132 kV
Category	S / L	S
Total length (l <sub>G</sub> )	190 mm	190 mm

## Indicator

Type	PHE A 15 16.7
Part No.	766 677
Nominal voltage (U <sub>N</sub> )	15 kV / 16.7 Hz
Total length (l <sub>G</sub> )	930 mm
Diameter	24 mm
DB drawing No.	3 Ebgw 02.53

## Indicator with Gear Coupling

Type	PHE3 A 20 SL ZK
Part No.	767 722
Nominal voltage (U <sub>N</sub> )	20 kV
Category	S / L
Total length (l <sub>G</sub> )	230 mm

Type	PHE3 A 10 30 S	PHE3 A 60 132 SL ZK
Part No.	767 965	767 735
Nominal voltage (U <sub>N</sub> )	10 ... 30 kV	60 ... 132 kV
Category	S	S / L
Total length (l <sub>G</sub> )	230 mm	230 mm

## ASP Indicator

Category "S" and "L"

Type	ASP A 110 132 16.7 L	ASP A 110 420 L ZK
Part No.	767 564	767 591
Nominal voltage (U <sub>N</sub> )	110 ... 132 kV	110 ... 420 kV
Category	L	L
Total length (l <sub>G</sub> )	230 mm	230 mm

Type	ASP A 110 420 S ZK	ASP A 110 420 SL ZK
Part No.	767 592	767 593
Nominal voltage (U <sub>N</sub> )	110 ... 420 kV	110 ... 420 kV
Category	S	S / L
Total length (l <sub>G</sub> )	230 mm	230 mm

## Indicator with Test Prod

## Indicator with Test Prod

Type	PHE PK 15 16.7
Part No.	766 678
Nominal voltage (U <sub>N</sub> )	15 kV / 16.7 Hz
Total length (l <sub>G</sub> )	1900 mm
Diameter	20 mm
DB drawing No.	3 Ebgw 02.51

## STK Switching Stick Head

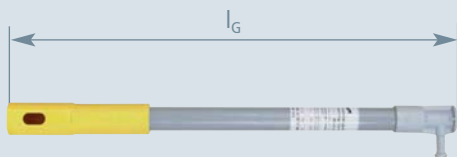

Type	SSK 36 STK 560
Part No.	766 164
Diameter	30 mm
Total length ( $l_G$ )	560 mm
Material (switching stick head)	Glass-fibre reinforced polyester tube
Colour	Grey
Material (switching pin)	Plastic-sheathed steel

## Operating Head with plug-in Coupling / T Pin Shaft

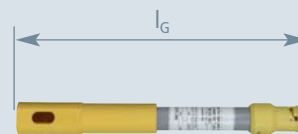

Plastic plug-in coupling (bayonet locking mechanism) for indoor use

Type	AK 36 SQ STK 360
Part No.	766 365
Diameter	30 mm
Total length ( $l_G$ )	360 mm
Material (operating head)	Plastic
Colour	Yellow

## SQL Operating Head

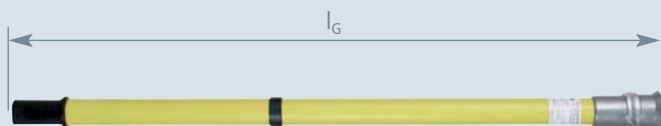

Type	ES SQL STK 43 1045
Part No.	766 074
Diameter	43 mm
Total length ( $l_G$ )	1045 mm
DB drawing No.	3 Ebgw 01.68

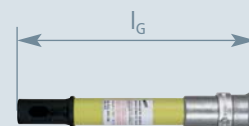
Operating Head with plug-in Coupling / long  
T Pin Shaft

Aluminium cone coupling with adjusting ring (bayonet locking mechanism) for earthing and short-circuiting in outdoor installations

Type	AK SQL STK 365
Part No.	766 465
Diameter	43 mm
Total length ( $l_G$ )	365 mm
Material (operating head)	Aluminium
Colour	Yellow

## Contacting Aid



For telescopic insulating sticks

Type	AK AH ZK ISMTC
Part No.	766 049
Total length ( $l_G$ )	340 mm

## Cleaning Head

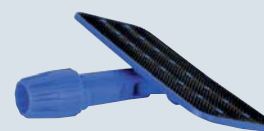

Flexibly adjustable, for attaching cleaning pads

Type	RK 230 100 AS25
Part No.	766 056
Diameter	25 mm
Dimensions	230 x 100 mm

## Accessory for Cleaning Head

## Rectangular Cleaning Pad

Type	RP 250 115 20
Part No.	766 057
Dimensions	250 x 115 x 20 mm

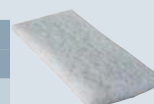

## Insulating Sticks

Accessory and Kit Parts

### Insulating Stick with universal Gear Coupling and Hand Strap

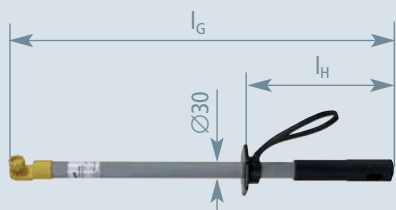

Insulating stick with black hand guard and hand strap for safe operation and plug-in coupling for extending the handle

Type	IS ZK STK HS 670
Part No.	766 369
Diameter	30 mm
Total length ( $l_G$ )	670 mm
Length (handle) ( $l_H$ )	265 mm
Material	Glass-fibre reinforced polyester tube
Colour	Grey

### Insulating Stick with M12 Threaded Pin

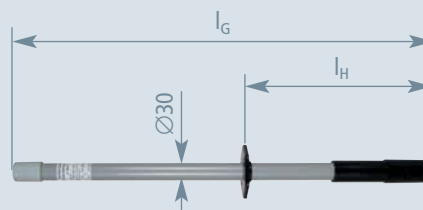

Plug-in coupling for extending the handle

Type	IS M12 STK 640
Part No.	766 331
Diameter	30 mm
Total length ( $l_G$ )	640 mm
Handle length ( $l_H$ )	370 mm
Material	Glass-fibre reinforced polyester tube
Colour	Grey

### ISN 36 STK Insulating Stick with Silicon Rubber Insulator

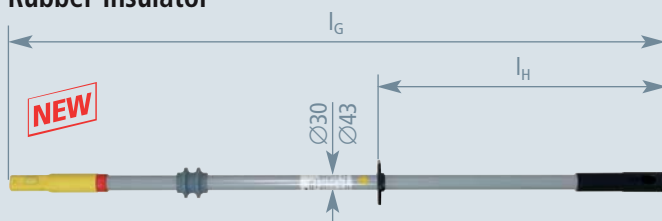

Plug-in coupling at both ends for attaching extension elements, operating heads or adapters

Type	ISN 36 STK 30 1280	ISN 36 STK 43 1280
Part No.	766 367	766 468
Nominal voltage ( $U_N$ )	Up to 36 kV	Up to 36 kV
Diameter	30 mm	43 mm
Total length ( $l_G$ )	1280 mm	1280 mm
Length (handle) ( $l_H$ )	560 mm	560 mm
Material	Glass-fibre reinforced polyester tube	Glass-fibre reinforced polyester tube
Colour	Grey	Grey

### ISN 36 STK Insulating Stick

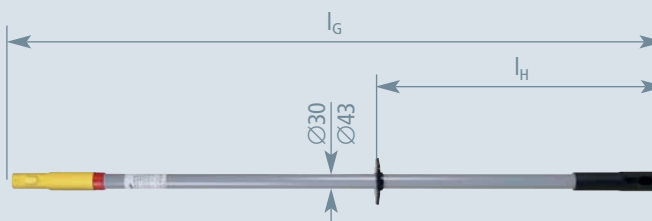

Plug-in coupling at both ends for attaching extension elements, operating heads or adapters

Typ	IS 36 STK 30 1280	IS 36 STK 43 1280
Art.-Nr.	766 363	766 463
Nominal voltage ( $U_N$ )	Up to 36 kV	Up to 36 kV
Diameter	30 mm	43 mm
Total length ( $l_G$ )	1280 mm	1280 mm
Length (handle) ( $l_H$ )	560 mm	560 mm
Material	Glass-fibre reinforced polyester tube	Glass-fibre reinforced polyester tube
Colour	Grey	Grey

### Insulating Stick for PHE Voltage Detectors for Overhead Lines

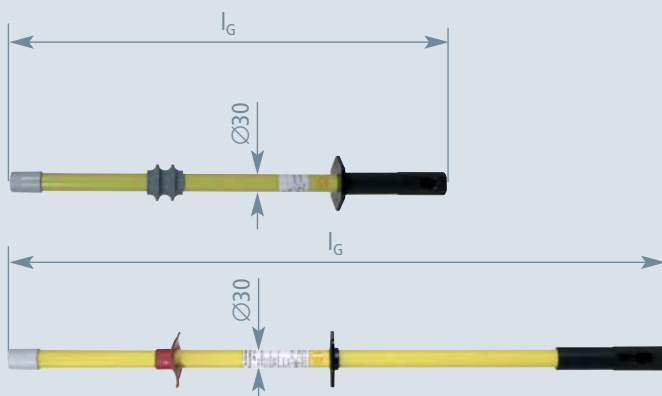

Type	IS M12 STK 30 720	IS M12 STK 30 1060
Part No.	766 072	766 075
Diameter	30 mm	30 mm
Total length ( $l_G$ )	720 mm	1060 mm
DB drawing No.	3 Ebgw 02.51	3 Ebgw 02.53



## Insulating Stick with Gear Coupling



Consists of one element, with foam-filled insulating element

Type	IS 25 ZK 2885
Part No.	766 048
Diameter	30 mm
Dimensions	2890 mm
Material	Glass-fibre reinforced polyester tube
End fitting	Non-slip plastic cap

## Insulating Elements

## Insulating Element with Gear Coupling

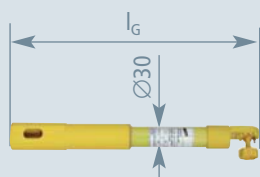

With plug-in coupling

Angle of the gear coupling – 30° / 0° / + 30°

Type	IT ZK30 STK 30 360
Part No.	766 358
Diameter	30 mm
Total length ( $l_G$ )	360 mm
Material	Glass-fibre reinforced polyester tube
Colour	Yellow

## Insulating Element with M12 threaded Pin

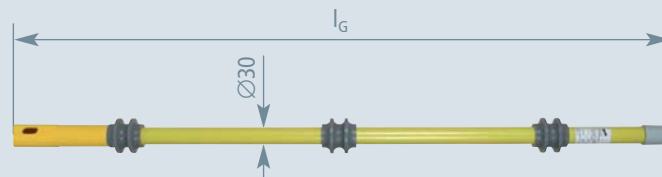

With plug-in coupling for extending the handle

Type	IT M12 STK 30 700	IT M12 STK 30 1150
Part No.	766 114	766 115
Nominal voltage ( $U_N$ )	Up to 60 kV	Up to 110 kV
Diameter	30 mm	30 mm
Total length ( $l_G$ )	700 mm	1150 mm
Material	Glass-fibre reinforced polyester tube	
Colour	Yellow	Yellow

## Insulating Element with plug-in Coupling

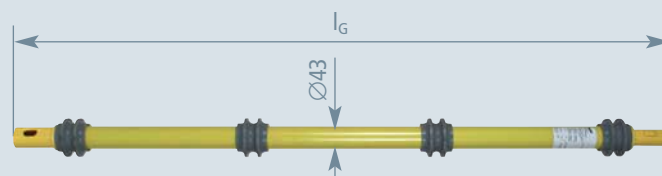

With plug-in coupling for extending the handle

Type	IT STK 43 1280
Part No.	766 128
Nominal voltage ( $U_N$ )	Up to 132 kV
Diameter	43 mm
Total length ( $l_G$ )	1280 mm
Material	Glass-fibre reinforced polyester tube
Colour	Yellow

## Handles and Extensions

Accessory and Kit Parts

### Handle

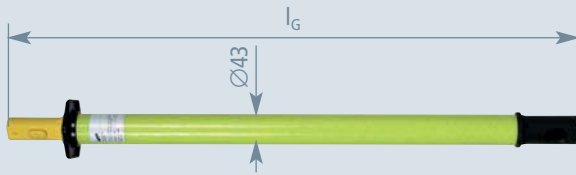

With hand guard and plug-in coupling for extending the handle

Type	H STK 43 800
Part No.	766 120
Diameter	43 mm
Total length ( $l_G$ )	800 mm

### HV STK Extension Handle

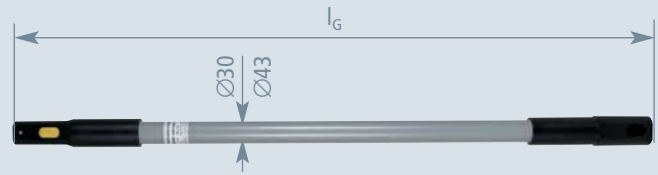

Plug-in coupling at both ends for extending the handle

Type	HV STK 30 710	HV STK 43 910	HV STK 43 1280
Part No.	766 335	766 456	766 466
Diameter	30 mm	43 mm	43 mm
Total length ( $l_G$ )	710 mm	910 mm	1280 mm
Material	Glass-fibre reinforced polyester tube		
Colour	Grey	Grey	Grey

### ISV 36 STK Insulating Stick Extension

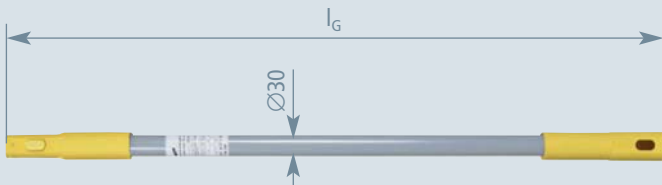

Plug-in coupling at both ends for extending the insertion depth or the handle

Type	ISV 36 STK 30 910	ISV 36 STK 30 1280
Part No.	766 356	766 366
Diameter	30 mm	30 mm
Total length ( $l_G$ )	910 mm	1280 mm
Material	Glass-fibre reinforced polyester tube	Glass-fibre reinforced polyester tube
Colour	Grey	Grey

### Extension Handle

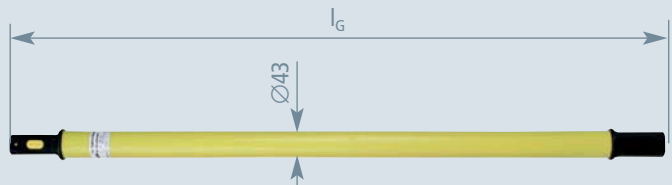

Plug-in coupling at both ends for extending the handle

Type	HV STK 43 975	HV STK 43 1045	HV STK 43 2350
Part No.	766 077	766 076	766 073
Diameter	43 mm	43 mm	43 mm
Total length ( $l_G$ )	975 mm	1045 mm	2350 mm
Material	Glass-fibre reinforced polyester tube		
DB drawing No.	3 Ebgw 02.53	3 Ebgw 02.53	3 Ebgw 02.51

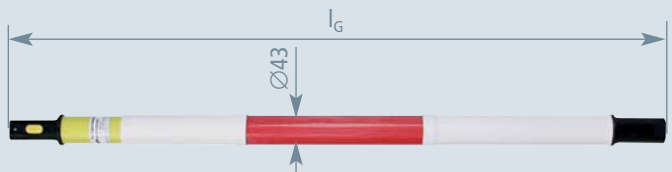

Type	HV STK RW 43 1045	HV STK RW 43 975
Part No.	766 078	766 079
Diameter	43 mm	43 mm
Total length ( $l_G$ )	1045 mm	975 mm
DB drawing No.	3 Ebgw 01.68	3 Ebgw 01.68

## STK End Fitting



For use as termination and protection

Type	A STK
Part No.	766 888
Diameter	30 / 43 mm
Total length (l <sub>G</sub> )	85 mm

## STK End Fitting with Eye

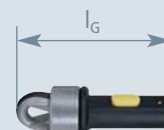

For use as protection and transport eye when working on overhead lines

Type	AR STK
Part No.	766 889
Diameter	30 / 43 mm
Total length (l <sub>G</sub> )	150 mm

## Adapter

## Adapter with M12 threaded Pin



and plug-in coupling

Type	AD M12 STK 30 350
Part No.	766 352
Diameter	30 mm
Total length (l <sub>G</sub> )	350 mm
Material	Glass-fibre reinforced polyester tube
Colour	Yellow

## Adapter with plug-in Coupling / T Pin Shaft



For extending the handle of IS PHE insulating sticks by means of an ES SQ or ES SQL earthing stick

Type	AD HV STK SQ
Part No.	766 313
Total length (l <sub>G</sub> )	280 mm

## Adapter with Gear Coupling



Type	AD ZK STK 30 360
Part No.	766 359
Diameter	30 mm
Total length (l <sub>G</sub> )	360 mm
Material	Glass-fibre reinforced polyester tube
Colour	Yellow

## Adapter



With gear coupling and cone-shaped support, accommodates cleaning sponges (Part No. 766 056)

Type	AD ZK 25 200
Part No.	766 055
Diameter	25 mm
Total length (l <sub>G</sub> )	200 mm

## Storage Devices

Accessory and Kit Parts

### For earthing and short-circuiting devices and sticks



- Wall-mounted
- Easy and safe storage of earthing and short-circuiting devices, voltage detectors and operating sticks (Ø30 or 43 mm)

Storage device for an earthing and short-circuiting device and an earthing stick

### For a Voltage Detector and an Earthing Stick

For a voltage detector and an earthing stick of any length

Hole spacing: 390 mm, holes: Ø7 mm



Type	HV P ST D24	HV P ST D30	HV P ST D40 45
Part No.	700 006	700 007	700 008
For stick diameters	24 mm	30 mm	40 ... 45 mm
Dimensions	530 x 30 x 136 mm	430 x 30 x 149 mm	530 x 30 x 149 mm
DB material No.	—	828 077	—

### For an Earthing and Short-Circuiting Device and an Earthing Stick



For an earthing and short-circuiting device and  
an earthing stick of any length

Hole spacing: 424 mm, holes:  $\varnothing$ 7 mm

Type	HV EKV ES30	HV EKV ES40
Part No.	700 000	700 002
For stick diameters	30 mm	43 mm
DB drawing No.	3 Ebgw 01.70	—
DB material No.	742 395	—

### For an Earthing and Short-Circuiting Device and an Earthing Stick up to 1.5 m



For an earthing and short-circuiting device and an earthing stick with a  
length up to 1.5 m

Hole spacing: 104 mm, holes:  $\varnothing$ 7 mm

Type	HV EKV ES30 1500
Part No.	700 003
For stick diameters	43 mm
Dimensions	214 x 150 mm

### For HH Fuses and a Fuse Tong – Single Parts

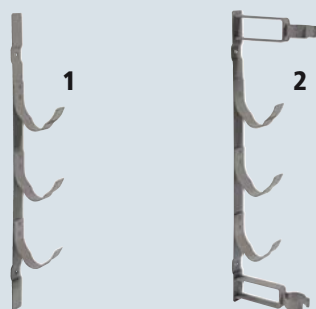

Wall-mounted, holes  $\varnothing$ 7 mm

Type	HV 3HH ET	HV 3HH SZ ET
Part No.	700 005	700 004
For	HH fuses	HH fuses and a fuse tong

### For HH Fuses and a Fuse Tong – Kit

Kit includes:			
Kit type	Kit Part No.	consisting of:	Pos. No.
HV 3HH	700 015	2x 700 005	1
HV 3HH SZ	700 014	1x 700 005	1
		1x 700 004	2



Wall-mounted, holes  $\varnothing$ 7 mm

Type	HV 3HH	HV 3HH SZ
Part No.	700 015	700 014
For	3 HH fuses	3 HH fuses and a fuse tong



## Installation Devices

Accessory and Kit Parts

### For fixed ball and earthing points

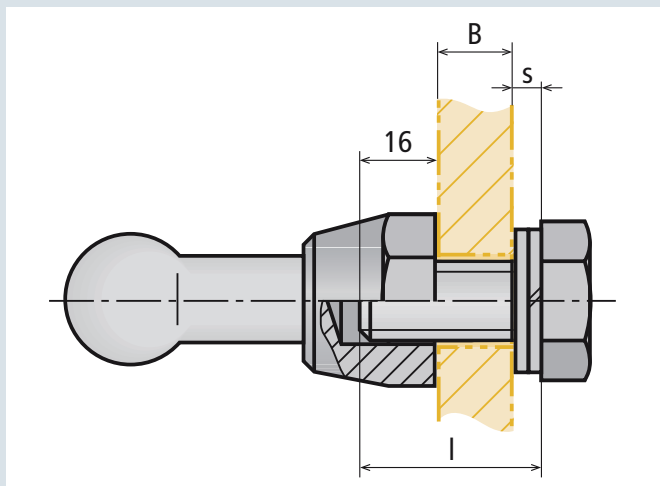

Determination of the required bolt length

- Hexagon bolt for fixing busbar connections according to DIN 43673 Part 1
- Spring-loaded pressure plate for installing M12 or M16 fixed points on aluminium busbars

#### Determination of the bolt length l

$$l \text{ (mm)} = B + s + 16$$

Important! Required bolt length < l

l = Bolt length

B = Thickness of the busbar

s = Thickness of the spring washer and washer

#### General Information:

Standard (hexagon bolts) In accordance with DIN 933

Standard (spring washers) In accordance with DIN 128

Standard (washers) In accordance with DIN 125

## Hexagon Bolts



Type	SKS M12 25 V2A	SKS M12 30 V2A	SKS M12 35 V2A	SKS M16 30 V2A
Part No.	561 925	561 930	561 935	561 931
Dimensions	M12 x 25 mm	M12 x 30 mm	M12 x 35 mm	M16 x 30 mm
Material	StSt A2-70	StSt A2-70	StSt A2-70	StSt A2-70
Tightening torque	80 Nm	80 Nm	80 Nm	150 Nm

## Spring Washers



Type	FR A12 V2A	FR A16 V2A
Part No.	524 912	524 913
Dimensions	A12 (s = 2.4) mm	A16 (s = 2.8) mm
Material	StSt A2-70	StSt A2-70

## Washers



Type	SCH A13 V2A	SCH A17 V2A
Part No.	525 912	525 916
Dimensions	A13 (s = 2.4) mm	A17 (s = 3.0) mm
Material	StSt A2-70	StSt A2-70

## Square spring-loaded Pressure Plate

For reliable contact and permanent installation of fixed ball points on aluminium busbars.

Pressure plates must be installed on both ends of the busbar.



Type	DP 40 40 B13 AL	DP 50 50 B17 AL
Part No.	525 001	525 002
Dimensions	M12, 40 x 40 x 6 mm	M16, 50 x 50 x 8 mm
Material	Highly resistant aluminium alloy	

Other lengths are available on request.

## Spare Parts

## Spare Parts



## Mignon Battery



Type	MZ 1.5V L91 FR6 LI 4	MZ 1.5V IEC LR6 AL
Part No.	766 611	766 613
Description	Mignon battery 1.5 V, lithium	Mignon battery 1.5 V, alkaline manganese
PU	4 pieces	1 piece

## Block Battery



Type	EB 9V LI	EB 9V AL
Part No.	767 712	767 713
Description	9 V block battery, lithium	9 V block battery, alkaline manganese
PU	1 piece	1 piece

## Electric Bulb



Type	GL 3.5V 0.2A E10
Part No.	766 605
Description	small electric bulb 3.5 V / 0.2 A
Suitable for	PHE

## Sealing Ring



Type	DR PS PHE3	DR PHV
Part No.	767 779	767 778
Suitable for	PHE III test prod and ASP electric field sensor	PHV basic device

## Protective Rubber for PHE



Type	FSG PHE
Part No.	767 776
Suitable for	PHE

## Protective Rubber for PHG II and PHV



Type	FSG PHG2 PHV
Part No.	767 777
Suitable for	PHG II and PHV

## Plastic Star Grip Screw

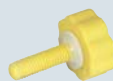

Type	KS SG BLS 8
Part No.	766 105
Suitable for	Universal gear coupling

## Support



Type	AH ISMTC
Part No.	766 038
Suitable for	telescopic insulating stick



<b>Index</b>	<b>Contents</b>	<b>Page</b>
<b>Index of Part No.</b>	Part No. Instruction for use No. Weight Packing unit Quantity per unit Page	212
<b>Type / Product Index</b>	Type Part No. Product Page	217
<b>Legal Notes</b>		225
<b>Abbreviations</b>		
<b>Conversion List EaS Devices</b>	Part No. (old) Variant No. (new)	226
<b>Key Words</b>		228

## Index of Part No.

Part No.	Instr. No.	Weight	VPE	VE	Page	Part No.	Instr. No.	Weight	VPE	VE	Page	Part No.	Instr. No.	Weight	VPE	VE	Page
336 020	—	118 g	1	pc(s).	81	715 500	—	10.81 kg	1	pc(s).	89	745 016	—	467 g	1	pc(s).	117
336 025	—	252 g	1	pc(s).	81	716 001	—	184 g	1	m	89	745 017	—	277 g	1	pc(s).	117
524 912	—	4 g	1	pc(s).	208	716 100	—	1.17 kg	1	pc(s).	88	745 018	—	271 g	1	pc(s).	117
524 913	—	8 g	1	pc(s).	208	716 200	—	1.07 kg	1	pc(s).	88	745 105	1502	1.83 kg	1	pc(s).	121
525 001	—	19 g	10	pc(s).	208	716 300	—	1 kg	1	pc(s).	88	745 106	1502	890 g	1	pc(s).	190
525 002	—	37 g	10	pc(s).	208	716 401	—	1.88 kg	1	pc(s).	89	745 107	1502	286 g	1	pc(s).	121
525 912	—	5 g	1	pc(s).	208	716 500	—	2.1 kg	1	pc(s).	89	745 108	1502	20 g	1	pc(s).	121
525 916	—	10 g	1	pc(s).	208	720 010	1018	314 g	1	pc(s).	79	745 109	1502	18 g	1	pc(s).	121
561 925	—	35 g	1	pc(s).	208	720 012	1018	347 g	1	pc(s).	79	745 201	1034	65 g	1	pc(s).	118
561 930	—	39 g	1	pc(s).	208	720 014	1018	329 g	1	pc(s).	79	745 202	1034	90 g	1	pc(s).	118
561 931	—	77 g	1	pc(s).	208	720 016	1018	309 g	1	pc(s).	79	745 203	1034	102 g	1	pc(s).	118
561 935	—	42 g	1	pc(s).	208	720 018	1018	296 g	1	pc(s).	79	745 204	1034	145 g	1	pc(s).	118
644 000	—	4.45 kg	1	pc(s).	97	720 018	1018	296 g	1	pc(s).	79	745 302	—	110 g	1	pc(s).	117
700 000	—	1.16 kg	1	pc(s).	207	720 020	1018	276 g	1	pc(s).	79	745 325	—	1.85 kg	1	pc(s).	115
700 002	—	1.15 kg	1	pc(s).	207	725 001	—	207 g	1	m	89	745 326	—	1.8 kg	1	pc(s).	115
700 003	—	700 g	1	pc(s).	207	725 010	1018	410 g	1	pc(s).	79	745 335	—	2.85 kg	1	pc(s).	115
700 004	—	1 kg	1	pc(s).	207	725 012	1018	400 g	1	pc(s).	79	745 336	—	2.8 kg	1	pc(s).	115
700 005	—	707 g	1	pc(s).	207	725 014	1018	385 g	1	pc(s).	79	745 340	—	700 g	1	pc(s).	115
700 006	—	780 g	1	pc(s).	206	725 016	1018	365 g	1	pc(s).	79	745 345	—	1.19 kg	1	pc(s).	117
700 007	—	780 g	1	pc(s).	206	725 018	1018	345 g	1	pc(s).	79	745 346	—	1.48 kg	1	pc(s).	117
700 008	—	803 g	1	pc(s).	206	725 020	1018	320 g	1	pc(s).	79	745 358	—	1.15 kg	1	pc(s).	117
700 014	—	1.71 kg	1	pc(s).	207	725 100	—	1.48 kg	1	pc(s).	88	745 359	—	1.24 kg	1	pc(s).	117
700 015	—	1.41 kg	1	pc(s).	207	725 100	—	1.48 kg	1	pc(s).	88	745 360	—	1.43 kg	1	pc(s).	117
705 500	—	122 g	1	pc(s).	81	725 200	—	1.27 kg	1	pc(s).	88	745 363	—	900 g	1	pc(s).	117
705 501	—	152 g	1	pc(s).	81	725 300	—	1.58 kg	1	pc(s).	88	745 365	—	687 g	1	pc(s).	117
705 504	—	183 g	1	pc(s).	81	725 401	—	1.99 kg	1	pc(s).	89	745 370	—	6.07 kg	1	pc(s).	119
705 510	—	240 g	1	pc(s).	81	725 500	—	2.22 kg	1	pc(s).	89	745 371	—	6.07 kg	1	pc(s).	119
706 200	1018	172 g	1	pc(s).	78	728 300	1011	1.21 kg	1	pc(s).	82	745 372	—	6.57 kg	1	pc(s).	119
706 235	1018	219 g	1	pc(s).	77	728 312	1733	270 g	1	pc(s).	92	745 375	—	5.61 kg	1	pc(s).	119
706 300	1018	129 g	1	pc(s).	76	728 316	—	1.05 kg	1	pc(s).	82	745 376	—	5.54 kg	1	pc(s).	119
706 600	1018	158 g	1	pc(s).	78	728 320	—	855 g	1	pc(s).	82	745 400	1034	417 g	1	pc(s).	118
706 645	1018	274 g	1	pc(s).	77	728 325	—	1.12 kg	1	pc(s).	82	745 414	1707	285 g	1	pc(s).	122
707 200	1018	204 g	1	pc(s).	78	728 500	1011	1.82 kg	1	pc(s).	82	745 415	1707	275 g	1	pc(s).	122
707 235	1018	259 g	1	pc(s).	78	728 501	1011	1.57 kg	1	pc(s).	184	745 500	1034	7.57 kg	1	pc(s).	116
707 600	1018	191 g	1	pc(s).	78	728 502	1011	708 g	1	pc(s).	184	745 502	1034	360 g	1	pc(s).	118
707 645	1018	299 g	1	pc(s).	78	728 503	1011	453 g	1	pc(s).	184	745 503	1747	154 g	1	pc(s).	115
712 001	—	1.23 kg	1	m	89	728 520	1011	1.55 kg	1	pc(s).	82	745 602	1034	580 g	1	pc(s).	118
712 100	—	7.06 kg	1	pc(s).	88	731 011	1011	690 g	1	pc(s).	83	745 900	1034	3.71 kg	1	pc(s).	188
712 200	—	5.67 kg	1	pc(s).	88	731 013	1011	850 g	1	pc(s).	83	745 901	1351	6.89 kg	1	pc(s).	114
712 300	—	5.5 kg	1	pc(s).	88	731 015	1011	1 kg	1	pc(s).	83	745 902	1034	1.62 kg	1	pc(s).	190
712 301	—	4.72 kg	1	pc(s).	88	731 027	1011	1.97 kg	1	pc(s).	83	745 903	1351	7 kg	1	pc(s).	114
712 401	—	8.53 kg	1	pc(s).	89	731 037	1011	2.66 kg	1	pc(s).	83	745 905	1351	75 g	1	pc(s).	115
712 500	—	9.48 kg	1	pc(s).	89	735 001	—	366 g	1	m	89	745 910	1351	190 g	1	pc(s).	115
715 001	—	1.52 kg	1	m	89	735 100	—	2.23 kg	1	pc(s).	88	745 915	1351	420 g	1	pc(s).	115
715 100	—	8.55 kg	1	pc(s).	88	735 200	—	1.67 kg	1	pc(s).	88	745 921	1351	220 g	1	pc(s).	115
715 200	—	6.67 kg	1	pc(s).	88	735 300	—	2.08 kg	1	pc(s).	88	745 922	1351	220 g	1	pc(s).	115
715 300	—	6.5 kg	1	pc(s).	88	735 401	—	2.59 kg	1	pc(s).	89	745 952	—	4.9 kg	1	pc(s).	190
715 301	—	5.8 kg	1	pc(s).	88	735 500	—	2.9 kg	1	pc(s).	89	745 953	—	4.95 kg	1	pc(s).	190
715 401	—	9.68 kg	1	pc(s).	89	740 124	—	255 g	1	pc(s).	179	750 001	—	535 g	1	m	89
						740 300	1011	700 g	1	pc(s).	120	750 041	—	4.22 kg	1	pc(s).	179
						740 800	1011	1.25 kg	1	pc(s).	120	750 042	—	4.06 kg	1	pc(s).	179
						742 225	1011	3.49 kg	1	pc(s).	120	750 100	—	3.1 kg	1	pc(s).	88
						742 425	1011	3.78 kg	1	pc(s).	120	750 196	1011	26.58 kg	1	pc(s).	174
												750 200	1011	16.95 kg	1	pc(s).	175
												750 202	—	2.47 kg	1	pc(s).	88
												750 210	1011	13.44 kg	1	pc(s).	174
												750 211	1011	15.55 kg	1	pc(s).	175
												750 212	1011	13 kg	1	pc(s).	176



## Index of Part No.

Part No.	Instr. No.	Weight	VPE	VE	Page	Part No.	Instr. No.	Weight	VPE	VE	Page	Part No.	Instr. No.	Weight	VPE	VE	Page
750 213	1011	8.76 kg	1	pc(s).	176	759 003	—	6.2 kg	1	pc(s).	188	765 051	1435	2.29 kg	1	pc(s).	59
750 214	1011	15.6 kg	1	pc(s).	175	759 111	1455	200 g	1	pc(s).	35	765 052	1435	2.59 kg	1	pc(s).	59
750 215	1011	7.3 kg	1	pc(s).	178	759 121	1455	154 g	1	pc(s).	35	766 001	1119	416 g	1	pc(s).	55
750 300	—	2.5 kg	1	pc(s).	88	759 300	1455	1.2 kg	1	pc(s).	34	766 002	1708	810 g	1	pc(s).	55
750 301	—	2.21 kg	1	pc(s).	88	759 603	1455	205 g	1	pc(s).	35	766 036	—	968 g	1	pc(s).	189
750 401	—	3.68 kg	1	pc(s).	89	759 604	1455	349 g	1	pc(s).	35	766 037	1494	6.56 kg	1	pc(s).	17
750 500	—	250 g	1	pc(s).	81	759 605	1455	336 g	1	pc(s).	35	766 038	—	275 g	1	pc(s).	209
750 510	—	4.11 kg	1	pc(s).	89	759 606	1450	1.63 kg	1	pc(s).	36	766 039	—	712 g	1	pc(s).	192
751 040	1011	2.6 kg	1	pc(s).	179	759 608	1455	295 g	1	pc(s).	35	766 040	1785	820 g	1	pc(s).	60
751 085	1011	4.98 kg	1	pc(s).	179	759 610	1455	405 g	1	pc(s).	35	766 041	1785	1 kg	1	pc(s).	60
751 086	—	9 kg	1	pc(s).	178	759 611	1455	346 g	1	pc(s).	35	766 042	1785	1.12 kg	1	pc(s).	60
751 087	—	9.13 kg	1	pc(s).	178	759 612	1450	1.8 kg	1	pc(s).	36	766 048	—	2.6 kg	1	pc(s).	203
751 120	1011	6.86 kg	1	pc(s).	179	759 615	1455	400 g	1	pc(s).	35	766 049	—	165 g	1	pc(s).	201
751 121	—	11.14 kg	1	pc(s).	178	759 616	1450	1.9 kg	1	pc(s).	36	766 055	—	120 g	1	pc(s).	205
751 122	—	11.27 kg	1	pc(s).	178	759 620	1455	340 g	1	pc(s).	35	766 056	—	204 g	1	pc(s).	201
751 126	—	10.88 kg	1	pc(s).	178	759 621	1455	370 g	1	pc(s).	35	766 057	—	75 g	1	Sa	201
751 127	—	11.01 kg	1	pc(s).	178	759 622	1455	425 g	1	pc(s).	35	766 072	—	400 g	1	pc(s).	202
751 130	1011	7.39 kg	1	pc(s).	179	759 624	1450	1.8 kg	1	pc(s).	36	766 073	—	1.6 kg	1	pc(s).	204
751 140	1011	7.93 kg	1	pc(s).	179	759 630	1455	344 g	1	pc(s).	35	766 074	1707	1.2 kg	1	pc(s).	201
751 150	1011	4.8 kg	1	pc(s).	179	759 633	1455	443 g	1	pc(s).	35	766 075	—	520 g	1	pc(s).	202
751 191	1011	8.82 kg	1	pc(s).	179	759 998	—	3.32 kg	1	pc(s).	189	766 076	—	800 g	1	pc(s).	204
751 192	1011	6.68 kg	1	pc(s).	179	759 999	—	2.38 kg	1	pc(s).	189	766 077	—	740 g	1	pc(s).	204
751 193	1011	10.28 kg	1	pc(s).	179	761 001	1707	400 g	1	pc(s).	103	766 078	—	1 kg	1	pc(s).	204
754 200	1018	131 g	1	pc(s).	77	761 002	1707	400 g	1	pc(s).	103	766 079	—	1 kg	1	pc(s).	204
754 235	1018	184 g	1	pc(s).	77	761 003	1707	840 g	1	pc(s).	103	766 100	1708	400 g	1	pc(s).	55
754 600	1018	116 g	1	pc(s).	77	761 004	1707	1.99 kg	1	pc(s).	103	766 105	—	10 g	1	pc(s).	209
754 645	1018	287 g	1	pc(s).	77	761 010	1707	980 g	1	pc(s).	103	766 111	1772	400 g	1	pc(s).	53
755 200	1018	220 g	1	pc(s).	77	761 011	1707	1.05 kg	1	pc(s).	103	766 114	—	—	1	pc(s).	203
755 225	1018	265 g	1	pc(s).	77	761 015	1707	1.35 kg	1	pc(s).	103	766 115	—	725 g	1	pc(s).	203
755 245	1018	278 g	1	pc(s).	77	761 016	1707	1.36 kg	1	pc(s).	103	766 120	—	690 g	1	pc(s).	204
755 501	—	298 g	1	pc(s).	81	761 070	—	800 g	1	pc(s).	104	766 122	—	800 g	1	pc(s).	55
755 600	1018	204 g	1	pc(s).	77	761 075	—	800 g	1	pc(s).	104	766 128	—	1.3 kg	1	pc(s).	203
755 626	1018	301 g	1	pc(s).	183	763 100	1709	600 g	1	pc(s).	57	766 164	—	400 g	1	pc(s).	201
755 627	1018	311 g	1	pc(s).	183	763 111	1773	600 g	1	pc(s).	56	766 210	1772	416 g	1	pc(s).	53
755 636	1018	310 g	1	pc(s).	183	763 150	1709	600 g	1	pc(s).	57	766 211	1772	419 g	1	pc(s).	53
755 645	1018	319 g	1	pc(s).	77	763 180	1709	850 g	1	pc(s).	57	766 215	1772	810 g	1	pc(s).	53
755 646	1018	330 g	1	pc(s).	183	763 180	1709	850 g	1	pc(s).	57	766 216	1772	820 g	1	pc(s).	53
756 200	1018	357 g	1	pc(s).	78	763 181	1773	850 g	1	pc(s).	56	766 222	1772	—	1	pc(s).	53
756 245	1018	434 g	1	pc(s).	77	763 211	1082	1.28 kg	1	pc(s).	64	766 298	1034	3.7 kg	1	pc(s).	188
756 300	1018	212 g	1	pc(s).	76	763 221	1082	—	1	pc(s).	64	766 300	1034	1.2 kg	1	pc(s).	188
756 600	1018	356 g	1	pc(s).	78	763 231	1082	—	1	pc(s).	65	766 301	1708	400 g	1	pc(s).	55
756 645	1018	470 g	1	pc(s).	77	763 241	1082	—	1	pc(s).	65	766 302	1034	4.38 kg	1	pc(s).	116
757 200	1018	395 g	1	pc(s).	78	763 510	1773	962 g	1	pc(s).	56	766 310	1772	400 g	1	pc(s).	53
757 245	1018	454 g	1	pc(s).	78	763 511	1773	610 g	1	pc(s).	56	766 311	1708	419 g	1	pc(s).	55
757 600	1018	370 g	1	pc(s).	78	763 512	1773	800 g	1	pc(s).	56	766 313	—	413 g	1	pc(s).	205
757 645	1018	491 g	1	pc(s).	78	763 610	1709	962 g	1	pc(s).	57	766 315	1708	820 g	1	pc(s).	55
758 001	1152	2.22 kg	1	pc(s).	126	763 611	1709	610 g	1	pc(s).	57	766 322	—	800 g	1	pc(s).	55
758 003	1152	1.95 kg	1	pc(s).	126	763 612	1709	800 g	1	pc(s).	57	766 323	1614	5.8 kg	1	pc(s).	51
758 015	1152	2.62 kg	1	pc(s).	126	763 615	1709	1.42 kg	1	pc(s).	57	766 324	1774	5.8 kg	1	pc(s).	49
758 020	1152	1.34 kg	1	pc(s).	125	763 620	1709	800 g	1	pc(s).	57	766 325	1614	5.6 kg	1	pc(s).	51
758 021	1152	1.1 kg	1	pc(s).	125	765 001	—	190 g	1	pc(s).	103	766 326	1774	5.6 kg	1	pc(s).	49
758 022	1152	700 g	1	pc(s).	125	765 005	—	117 g	1	pc(s).	52	766 331	—	375 g	1	pc(s).	202
758 025	—	1.49 kg	1	pc(s).	127	765 009	—	145 g	1	pc(s).	52	766 332	1772	—	1	pc(s).	53
765 001	—	190 g	1	pc(s).	103	765 040	1435	2.13 kg	1	pc(s).	59	766 335	—	400 g	1	pc(s).	204
765 005	—	117 g	1	pc(s).	52	765 041	1435	2.28 kg	1	pc(s).	59	766 340	1636	3 kg	1	pc(s).	185
765 009	—	145 g	1	pc(s).	52	765 042	1435	2.59 kg	1	pc(s).	59	766 352	—	250 g	1	pc(s).	205
765 040	1435	2.13 kg	1	pc(s).	59	765 050	1435	2.15 kg	1	pc(s).	59	766 356	—	400 g	1	pc(s).	204
765 041	1435	2.28 kg	1	pc(s).	59	766 051	1435	2.29 kg	1	pc(s).	59	766 358	—	—	1	pc(s).	203
765 042	1435	2.59 kg	1	pc(s).	59	766 052	1435	2.59 kg	1	pc(s).	59						
765 050	1435	2.15 kg	1	pc(s).	59												

## Index of Part No.

Part No.	Instr. No.	Weight	VPE	VE	Page	Part No.	Instr. No.	Weight	VPE	VE	Page	Part No.	Instr. No.	Weight	VPE	VE	Page
766 359	—	—	1	pc(s).	205	767 110	1239	119 g	1	pc(s).	41	767 721	1598	1.23 kg	1	pc(s).	13
766 363	—	600 g	1	pc(s).	202	767 111	1259	190 g	1	pc(s).	42	767 722	—	474 g	1	pc(s).	200
766 364	—	240 g	1	pc(s).	48	767 112	1259	150 g	1	pc(s).	42	767 724	—	4.22 kg	1	pc(s).	19
766 365	—	200 g	1	pc(s).	201	767 121	1281	150 g	1	pc(s).	43	767 725	—	9.1 kg	1	pc(s).	19
766 366	—	600 g	1	pc(s).	204	767 122	1281	185 g	1	pc(s).	43	767 726	—	235 g	1	pc(s).	200
766 367	1774	600 g	1	pc(s).	202	767 125	—	1.26 kg	1	pc(s).	164	767 730	1598	1.13 kg	1	pc(s).	13
766 368	—	340 g	1	pc(s).	17	767 129	—	—	1	pc(s).	200	767 731	1598	1.29 kg	1	pc(s).	13
766 369	—	388 g	1	pc(s).	202	767 130	1783	3.46 kg	1	pc(s).	167	767 732	—	420 g	1	pc(s).	200
766 450	1614	7.6 kg	1	pc(s).	51	767 131	—	6.2 kg	1	pc(s).	167	767 733	1598	1.29 kg	1	pc(s).	13
766 451	1774	7.6 kg	1	pc(s).	49	767 132	1260	640 g	1	pc(s).	44	767 734	—	420 g	1	pc(s).	200
766 452	1614	6.6 kg	1	pc(s).	51	767 133	1283	85 g	1	pc(s).	46	767 735	—	400 g	1	pc(s).	200
766 453	1774	6.6 kg	1	pc(s).	49	767 135	1323	85 g	1	pc(s).	46	767 740	1598	1.45 kg	1	pc(s).	13
766 456	1708	800 g	1	pc(s).	204	767 136	1337	65 g	1	pc(s).	46	767 750	1598	1.51 kg	1	pc(s).	13
766 463	—	1 kg	1	pc(s).	202	767 139	—	820 g	1	pc(s).	44	767 760	—	177 g	1	pc(s).	197
766 465	—	800 g	1	pc(s).	201	767 150	—	1.94 kg	1	pc(s).	45	767 761	—	282 g	1	pc(s).	197
766 466	1708	1 kg	1	pc(s).	204	767 403	1535	2.15 kg	1	pc(s).	25	767 762	—	353 g	1	pc(s).	197
766 468	1774	1 kg	1	pc(s).	202	767 406	1535	1.3 kg	1	pc(s).	25	767 763	—	529 g	1	pc(s).	197
766 541	1507	397 g	1	pc(s).	123	767 410	1535	1.4 kg	1	pc(s).	25	767 764	—	506 g	1	pc(s).	197
766 542	1507	71 g	1	pc(s).	123	767 413	1720	1.77 kg	1	pc(s).	166	767 766	—	129 g	1	pc(s).	197
766 543	1507	148 g	1	pc(s).	191	767 415	1365	1.52 kg	1	pc(s).	165	767 767	—	440 g	1	pc(s).	197
766 545	1507	397 g	1	pc(s).	123	767 416	1365	2.62 kg	1	pc(s).	165	767 768	—	445 g	1	pc(s).	197
766 601	—	319 g	1	pc(s).	191	767 418	1535	1.2 kg	1	pc(s).	25	767 771	—	600 g	1	pc(s).	197
766 602	—	1.31 kg	1	pc(s).	191	767 420	1535	2.38 kg	1	pc(s).	25	767 772	—	280 g	1	pc(s).	197
766 603	—	6 kg	1	pc(s).	188	767 428	1535	1.4 kg	1	pc(s).	25	767 776	—	58 g	1	pc(s).	209
766 605	—	2 g	1	pc(s).	209	767 430	1535	1.5 kg	1	pc(s).	25	767 777	—	46 g	1	pc(s).	209
766 611	—	94 g	1	Sa	209	767 433	1535	1.5 kg	1	pc(s).	25	767 778	—	3 g	1	pc(s).	209
766 613	—	24 g	1	pc(s).	209	767 438	1535	1.6 kg	1	pc(s).	25	767 779	—	3 g	1	pc(s).	209
766 614	—	600 g	1	pc(s).	191	767 500	—	280 g	1	pc(s).	191	767 903	1598	992 g	1	pc(s).	15
766 616	1138	5.09 kg	1	pc(s).	163	767 542	1606	5.35 kg	1	pc(s).	168	767 906	1598	992 g	1	pc(s).	15
766 617	1234	4.95 kg	1	pc(s).	163	767 552	1243	1.98 kg	1	pc(s).	28	767 910	1598	992 g	1	pc(s).	15
766 619	—	600 g	1	pc(s).	197	767 564	—	—	1	pc(s).	200	767 920	1598	1.1 kg	1	pc(s).	15
766 677	—	1.4 kg	1	pc(s).	200	767 565	—	2.03 kg	1	pc(s).	169	767 921	1788	1.65 kg	1	pc(s).	17
766 678	—	1.6 kg	1	pc(s).	200	767 571	1665	1.46 kg	1	pc(s).	27	767 922	1788	1.07 kg	1	pc(s).	17
766 703	—	800 g	1	pc(s).	188	767 572	1665	1.73 kg	1	pc(s).	27	767 930	1598	1.17 kg	1	pc(s).	15
766 704	—	720 g	1	pc(s).	192	767 573	1665	3.74 kg	1	pc(s).	27	767 931	1788	1.08 kg	1	pc(s).	17
766 706	1075	800 g	1	pc(s).	29	767 574	—	500 g	1	pc(s).	191	767 932	1788	1.07 kg	1	pc(s).	17
766 710	1075	1.7 kg	1	pc(s).	29	767 576	—	214 g	1	pc(s).	199	767 940	1598	1.39 kg	1	pc(s).	15
766 720	1075	1.7 kg	1	pc(s).	29	767 577	—	380 g	1	pc(s).	199	767 941	1598	1.17 kg	1	pc(s).	15
766 888	—	63 g	1	pc(s).	205	767 581	1665	957 g	1	pc(s).	27	767 950	1598	1.44 kg	1	pc(s).	15
766 889	—	172 g	1	pc(s).	205	767 582	1665	1.23 kg	1	pc(s).	27	767 951	1598	1.26 kg	1	pc(s).	15
766 913	—	42 g	1	pc(s).	196	767 583	1665	1.45 kg	1	pc(s).	27	767 960	1598	1.32 kg	1	pc(s).	15
766 915	—	220 g	1	pc(s).	196	767 585	1665	—	1	pc(s).	169	767 961	1598	1.32 kg	1	pc(s).	15
766 916	—	125 g	1	pc(s).	198	767 591	—	809 g	1	pc(s).	200	767 962	1598	1.77 kg	1	pc(s).	23
766 923	—	84 g	1	pc(s).	196	767 592	—	—	1	pc(s).	200	767 963	—	—	1	pc(s).	200
766 924	—	46 g	1	pc(s).	196	767 593	—	471 g	1	pc(s).	200	767 964	1598	—	1	pc(s).	23
766 925	—	10 g	1	pc(s).	196	767 602	1121	2.1 kg	1	pc(s).	32/172	767 965	—	—	1	pc(s).	200
766 927	—	15 g	1	pc(s).	196	767 650	1121	4.2 kg	1	pc(s).	31/171	767 970	1598	5.8 kg	1	pc(s).	21
766 940	—	145 g	1	pc(s).	199	767 655	1121	2.2 kg	1	pc(s).	31/171	767 971	1598	2.35 kg	1	pc(s).	21
766 941	—	150 g	1	pc(s).	199	767 660	1121	2.2 kg	1	pc(s).	31/171	767 972	—	—	1	pc(s).	200
766 950	—	339 g	1	pc(s).	199	767 665	1121	4.2 kg	1	pc(s).	31/171	767 973	1598	2.06 kg	1	pc(s).	21
766 960	—	310 g	1	pc(s).	198	767 670	1121	2.6 kg	1	pc(s).	32/172	767 974	—	—	1	pc(s).	200
766 996	—	4 kg	1	pc(s).	191	767 701	—	5.7 kg	1	pc(s).	188	767 975	1598	5.42 kg	1	pc(s).	21
766 997	—	2.39 kg	1	pc(s).	189	767 703	1598	1.01 kg	1	pc(s).	13	767 980	1598	5.98 kg	1	pc(s).	21
766 998	—	3.36 kg	1	pc(s).	189	767 706	1598	1.01 kg	1	pc(s).	13	767 981	1598	5.66 kg	1	pc(s).	22
766 999	—	3.32 kg	1	pc(s).	18	767 710	1598	1.01 kg	1	pc(s).	13	767 982	1598	7.4 kg	1	pc(s).	22
						767 711	1598	1.16 kg	1	pc(s).	13	767 983	1598	6.38 kg	1	pc(s).	23
767 101	1240	60 g	1	pc(s).	40	767 712	—	35 g	1	pc(s).	209	767 984	1598	6.2 kg	1	pc(s).	23
767 102	1240	62 g	1	pc(s).	40	767 713	—	44 g	1	pc(s).	209	767 990	1598	2.7 kg	1	pc(s).	21
767 107	—	880 g	1	pc(s).	190	767 720	1598	1.07 kg	1	pc(s).	13	767 991	1598	2.35 kg	1	pc(s).	22

## Index of Part No.

Part No.	Instr. No.	Weight	VPE	VE	Page	Part No.	Instr. No.	Weight	VPE	VE	Page	Part No.	Instr. No.	Weight	VPE	VE	Page
767 992	1598	3.82 kg	1	pc(s).	22	775 631	1011	290 g	1	pc(s).	100	785 265	1444	7.29 kg	1	pc(s).	147
767 993	1598	3.82 kg	1	pc(s).	23	775 636	1011	350 g	1	pc(s).	100	785 266	1444	709 g	1	pc(s).	147
767 996	—	2.3 kg	1	pc(s).	191							785 267	—	291 g	1	pc(s).	147
767 997	—	2.42 kg	1	pc(s).	189	784 032	1011	969 g	1	pc(s).	93	785 268	—	293 g	1	pc(s).	147
767 999	—	3.4 kg	1	pc(s).	189	784 038	1011	1.01 kg	1	pc(s).	93	785 269	—	292 g	1	pc(s).	147
						784 085	1011	872 g	1	pc(s).	93	785 271	—	17 g	1	pc(s).	147
769 300	1707	2.8 kg	1	pc(s).	106	784 201	1011	880 g	1	pc(s).	93	785 272	—	21 g	1	pc(s).	147
769 352	1707	4.8 kg	1	pc(s).	182	784 301	1011	1.7 kg	1	pc(s).	93	785 273	—	270 g	1	pc(s).	147
769 400	1707	3.68 kg	1	pc(s).	106	784 352	1011	806 g	1	pc(s).	180	785 274	—	33 g	1	Sa	141
769 500	1707	4.68 kg	1	pc(s).	106	784 401	1011	1.3 kg	1	pc(s).	93	785 275	—	63 g	1	Sa	141
769 502	1707	5.6 kg	1	pc(s).	182	784 461	1649	1.28 kg	1	pc(s).	95	785 279	—	68 g	1	Sa	141
769 503	1707	1.64 kg	1	pc(s).	108	784 463	1649	1.62 kg	1	pc(s).	95	785 280	—	60 g	1	Sa	141
769 504	1707	1.6 kg	1	pc(s).	108	784 480	1011	600 g	1	pc(s).	93	785 281	—	15 g	12	pc(s).	148
769 505	1707	1.46 kg	1	pc(s).	108	784 490	—	533 g	3	pc(s).	95	785 282	—	7 g	12	pc(s).	148
769 506	1707	6.5 kg	1	pc(s).	182	784 501	1011	1.95 kg	1	pc(s).	93	785 283	—	8 g	12	pc(s).	148
769 508	1707	4.5 kg	1	pc(s).	182	784 755	1011	1.54 kg	1	pc(s).	180	785 284	—	7 g	12	pc(s).	148
769 509	—	358 g	1	pc(s).	192							785 284	—	7 g	12	pc(s).	148
						785 100	1224	18 kg	1	pc(s).	136	785 295	—	2.5 kg	1	pc(s).	145
770 001	—	753 g	1	m	89	785 109	—	504 g	1	pc(s).	142	785 298	—	3.41 kg	1	pc(s).	147
770 100	—	4.22 kg	1	pc(s).	88	785 110	—	700 g	1	pc(s).	143	785 299	—	5.4 kg	1	pc(s).	145
770 200	—	3.07 kg	1	pc(s).	88	785 111	—	612 g	1	pc(s).	192	785 301	—	6 kg	1	pc(s).	139
770 300	—	3.5 kg	1	pc(s).	88	785 112	1224	17.8 kg	1	pc(s).	136	785 310	—	12.7 kg	1	pc(s).	143
770 301	—	2.96 kg	1	pc(s).	88	785 119	—	700 g	1	pc(s).	143	785 315	—	632 g	1	pc(s).	139
770 401	—	4.8 kg	1	pc(s).	89	785 120	1224	700 g	1	pc(s).	139	785 316	—	95 g	1	pc(s).	139
770 500	—	5.36 kg	1	pc(s).	89	785 121	—	110 g	1	pc(s).	139	785 317	—	130 g	1	pc(s).	139
						785 122	—	220 g	1	pc(s).	139	785 318	—	152 g	1	pc(s).	139
772 310	—	469 g	1	pc(s).	91	785 123	—	430 g	1	pc(s).	139	785 319	—	247 g	1	pc(s).	139
772 311	—	482 g	1	pc(s).	91	785 130	—	130 g	1	pc(s).	139	785 320	—	88 g	1	pc(s).	140
772 312	1011	480 g	1	pc(s).	99	785 131	—	160 g	1	pc(s).	139	785 321	—	97 g	1	pc(s).	140
772 313	1011	400 g	1	pc(s).	99	785 132	—	150 g	1	pc(s).	139	785 322	—	132 g	1	pc(s).	141
772 314	1011	446 g	1	pc(s).	96	785 140	—	340 g	1	pc(s).	140	785 323	—	182 g	1	pc(s).	141
772 320	—	785 g	1	pc(s).	91	785 150	—	320 g	1	pc(s).	140	785 324	—	89 g	1	pc(s).	141
772 321	—	756 g	1	pc(s).	91	785 151	—	260 g	1	pc(s).	140	785 325	—	600 g	1	pc(s).	139
772 322	1011	747 g	1	pc(s).	99	785 155	—	260 g	1	pc(s).	140	785 408	1622	9.8 kg	1	pc(s).	157
772 323	1011	876 g	1	pc(s).	99	785 160	—	90 g	1	pc(s).	140	785 425	—	280 g	1	pc(s).	192
772 324	1011	719 g	1	pc(s).	96	785 170	—	255 g	1	pc(s).	140	785 427	1767	300 g	1	pc(s).	154
772 330	—	560 g	1	pc(s).	91	785 171	—	105 g	1	pc(s).	140	785 440	1622	2.25 kg	1	pc(s).	157
772 331	—	566 g	1	pc(s).	91	785 172	—	100 g	1	pc(s).	140	785 441	1622	2.2 kg	1	pc(s).	157
772 340	—	878 g	1	pc(s).	91	785 180	—	150 g	1	pc(s).	142	785 445	1622	1.07 kg	1	pc(s).	157
772 341	—	902 g	1	pc(s).	91	785 181	—	181 g	1	pc(s).	142	785 455	—	3.6 kg	1	pc(s).	159
						785 190	—	389 g	1	pc(s).	142	785 456	—	3.6 kg	1	m	159
773 034	—	634 g	1	pc(s).	91	785 200	—	180 g	1	pc(s).	141	785 457	—	36 kg	1	pc(s).	159
773 130	—	801 g	1	pc(s).	91	785 210	—	260 g	1	pc(s).	142	785 458	—	5.8 kg	1	m	159
773 234	—	661 g	1	pc(s).	91	785 212	—	71 g	1	pc(s).	141	785 459	—	56 kg	1	pc(s).	159
773 236	—	714 g	1	pc(s).	96	785 213	—	320 g	1	pc(s).	143	785 465	—	41.5 kg	1	pc(s).	158
773 251	1011	901 g	1	pc(s).	181	785 214	—	320 g	1	pc(s).	143	785 466	—	830 g	1	m	158
773 330	—	830 g	1	pc(s).	91	785 215	—	320 g	1	pc(s).	143	785 467	—	38 kg	1	pc(s).	158
773 331	1011	793 g	1	pc(s).	96	785 216	—	320 g	1	pc(s).	143	785 468	—	1.64 kg	1	m	158
						785 217	—	320 g	1	pc(s).	143	785 471	—	20 kg	1	pc(s).	159
774 034	—	662 g	1	pc(s).	98	785 218	—	320 g	1	pc(s).	143	785 472	—	1.95 kg	1	m	159
774 130	1011	780 g	1	pc(s).	98	785 219	—	320 g	1	pc(s).	143	785 490	—	240 g	1	pc(s).	155
774 234	—	772 g	1	pc(s).	98	785 220	—	82 g	1	pc(s).	140	785 491	—	140 g	1	Pa	155
774 251	1011	955 g	1	pc(s).	181	785 221	—	200 g	1	pc(s).	140	785 492	—	140 g	1	Pa	155
774 330	1011	941 g	1	pc(s).	98	785 223	—	290 g	1	pc(s).	140	785 493	—	160 g	1	Pa	155
774 434	—	712 g	1	pc(s).	98	785 224	—	11 g	1	Sa	142	785 494	—	160 g	1	Pa	155
774 530	1011	700 g	1	pc(s).	98	785 229	—	6 kg	1	pc(s).	139	785 495	—	290 g	1	Pa	155
						785 259	—	94 g	1	pc(s).	141	785 496	—	290 g	1	Pa	155
775 621	1011	311 g	1	pc(s).	100	785 260	1396	21.5 kg	1	pc(s).	145	785 497	—	660 g	1	pc(s).	155
775 626	1011	343 g	1	pc(s).	100	785 261	—	760 g	1	pc(s).	145	785 502	1261	7.2 kg	1	pc(s).	133
						785 264	—	2.5 kg	1	pc(s).	145	785 506	—	5.3 kg	1	pc(s).	133

## Index of Part No.

Part No.	Instr. No.	Weight	VPE	VE	Page	Part No.	Instr. No.	Weight	VPE	VE	Page	Part No.	Instr. No.	Weight	VPE	VE	Page
785 515	—	68 g	1	pc(s).	134	785 646	—	760 g	1	pc(s).	159	792 030	1011	610 g	1	pc(s).	101
785 520	—	240 g	1	pc(s).	133	785 647	—	73 g	1	pc(s).	159	792 190	1011	1.2 kg	1	pc(s).	101
785 521	—	107 g	1	pc(s).	133	785 648	—	19 g	1	pc(s).	159	792 450	1011	2.95 kg	1	pc(s).	181
785 522	—	157 g	1	pc(s).	133	785 649	—	2 g	1	pc(s).	159	792 453	1011	2.95 kg	1	pc(s).	181
785 523	—	211 g	1	pc(s).	133	785 650	—	22 g	1	pc(s).	160	795 001	—	1 kg	1	m	89
785 530	—	118 g	1	pc(s).	133	785 652	—	85 g	1	pc(s).	160	795 040	—	890 g	1	pc(s).	84
785 540	—	100 g	1	pc(s).	133	785 740	—	336 g	1	pc(s).	151	795 100	—	5.96 kg	1	pc(s).	88
785 541	—	41 g	1	pc(s).	133	785 741	—	336 g	1	pc(s).	151	795 138	—	4.7 kg	1	pc(s).	85
785 542	—	42 g	1	pc(s).	133	785 742	—	336 g	1	pc(s).	151	795 139	—	5.8 kg	1	pc(s).	85
785 543	—	43 g	1	pc(s).	134	785 743	—	336 g	1	pc(s).	151	795 141	—	4.7 kg	1	pc(s).	85
785 550	—	104 g	1	pc(s).	134	785 744	—	336 g	1	pc(s).	151	795 142	—	3.2 kg	1	pc(s).	85
785 551	—	34 g	1	pc(s).	140	785 746	1767	379 g	1	pc(s).	151	795 143	—	3.5 kg	1	pc(s).	85
785 552	—	47 g	1	pc(s).	140	785 747	1767	379 g	1	pc(s).	151	795 145	—	5.8 kg	1	pc(s).	85
785 555	—	100 g	1	pc(s).	134	785 748	1767	388 g	1	pc(s).	151	795 148	—	3.2 kg	1	pc(s).	85
785 560	—	52 g	1	pc(s).	133	785 749	1767	388 g	1	pc(s).	151	795 149	—	3.5 kg	1	pc(s).	85
785 570	—	47 g	1	pc(s).	134	785 796	1680	200 g	1	Pa	153	795 200	—	4.67 kg	1	pc(s).	88
785 580	—	48 g	1	pc(s).	134	785 797	1680	200 g	1	Pa	153	795 213	1011	114 g	1	pc(s).	85
785 585	—	21 g	1	pc(s).	142	785 798	1680	200 g	1	Pa	153	795 214	1011	118 g	1	pc(s).	85
785 590	—	50 g	1	pc(s).	133	785 799	1680	200 g	1	Pa	153	795 300	—	4.5 kg	1	pc(s).	88
785 591	—	47 g	1	pc(s).	133	785 800	1680	200 g	1	Pa	153	795 301	—	4.38 kg	1	pc(s).	88
785 592	—	50 g	1	pc(s).	143	785 940	1379	10.85 kg	1	pc(s).	137	795 401	—	7.56 kg	1	pc(s).	89
785 595	—	15 g	1	Sa	134	785 950	1508	27.3 kg	1	pc(s).	138	795 500	—	8.39 kg	1	pc(s).	89
785 596	—	18 g	1	Sa	134	785 951	—	21.2 kg	1	pc(s).	139	799 009	—	5.1 kg	1	pc(s).	97
785 637	—	14 g	1	pc(s).	160	785 952	—	1.43 kg	1	pc(s).	139	799 019	—	328 g	1	pc(s).	97
785 638	—	6 g	1	pc(s).	160	785 953	—	121 g	1	pc(s).	142	923 110	1373	40 g	10	pc(s).	186
785 639	—	15 g	1	pc(s).	160	790 150	1011	450 g	1	pc(s).	100	923 116	1372	42 g	10	pc(s).	186
785 640	—	55 g	1	pc(s).	160	790 160	1011	737 g	1	pc(s).	100	923 117	1418	42 g	10	pc(s).	186
785 641	—	55 g	1	pc(s).	160	790 250	—	193 g	1	pc(s).	80	923 118	1513	38 g	10	pc(s).	186
785 642	—	75 g	1	pc(s).	160	790 251	—	248 g	1	pc(s).	80	923 119	1514	39 g	10	pc(s).	186
785 643	—	80 g	1	pc(s).	160	790 260	—	180 g	1	pc(s).	80						
785 644	—	80 g	1	pc(s).	160	790 261	—	277 g	1	pc(s).	80						
785 645	—	420 g	1	pc(s).	154												

Type	Part No.	Product	Page
A 30 60 S	767 972	Indicator, 30..60kV, cat. S	200
A 30 60 L	767 974	Indicator, 30..60kV, cat. L	200
A STK	766 888	STK end fitting	205
AD ES SQ SK	765 001	Adapter earthing stick, SQ, SK	103
AD HV STK SQ	766 313	Adapter plug-in coupling, SQ	205
AD M12 STK 30 350	766 352	Adapter w. M12 a. STK, Ø30mm, 350mm	205
AD ZK 25 200	766 055	Adapter w. ZK f. operating head, Ø25mm, 200mm	205
AD ZK STK 30 360	766 359	Adapter w. ZK, Ø30mm, 360mm	205
AH ISMTC	766 038	Support f. ISMTC	209
AK 36 SK STK 330	766 364	Operating head w. STK, SK, 330mm, -36kV/50Hz	48
AK 36 SQ STK 360	766 365	Operating head w.. STK, SQ, 360mm, -36kV	201
AK AH ZK ISMTC	766 049	Contacting aid w. ZK f. ISMTC	201
AK RS 2 ZK MS	785 323	Dual operating head 2-fach w. ZK f. FRS MS, -36kV	141
AK RS S ZK MS	785 324	Rigid operating head w. ZK f. FRS MS, -36kV	141
AK RS ZK MS	785 322	Single operating head w. ZK f. FRS MS, -36kV	141
AK SD KEV MS	785 267	Straight operating head f. KEV MS	147
AK SD W30 KEV MS	785 268	30° Angled operating head, f. MS screw driver set	147
AK SD W70 KEV MS	785 269	70° Angled operating head, f. MS screw driver set	147
AK SQL STK 365	766 465	Operating head w. STK a. SQL, 365mm, 36kV	201
AKA TF ZK MS	785 259	Operating head adapter w. ZK f. TFRS MS	141
AP 152 G	785 110	Cover, 1,5 x 2m, yellow	143
APG 8	785 796	Arc-fault-tested protective gloves, size 8	153
APG 9	785 797	Arc-fault-tested protective gloves, size 9	153
APG 10	785 798	Arc-fault-tested protective gloves, size 10	153
APG 11	785 799	Arc-fault-tested protective gloves, size 11	153
APG 12	785 800	Arc-fault-tested protective gloves, size 12	153
APS 12C FS	785 749	Arc-fault-tested face shield, 12 Cal w. strap	151
APS 12C SC	785 747	Arc-fault-tested face shield, 12 Cal w. clip	151
ASP 110 420 L	767 581	Non-contact voltage detector kit 110..420kV/50Hz, L	27
ASP 110 420 S	767 582	Non-contact voltage detector kit 110..420kV/50Hz, S	27
ASP 110 420 S L	767 583	Non-contact voltage detector kit 110..420kV/50Hz, S/L	27
ASP 110 132 16.7 L	767 585	Non-contact voltage detector kit 110..132kV/16.7Hz	169
ASP A 110 132 16.7 L	767 564	Indicator f. ASP, 110..132kV/16.7Hz, cat. L	200
ASP A 110 420 L ZK	767 591	Indicator f. ASP, 110..420kV, cat. L	200
ASP A 110 420 S ZK	767 592	Indicator f. ASP, 110..420kV, cat. S	200
ASP A 110 420 SL ZK	767 593	Indicator f. ASP, 110..420kV, cat. S/L	200
APS CL2 FS	785 748	Arc-fault-tested face shield w. strap	151
APS CL2 SC	785 746	Arc-fault-tested face shield w. clip	151
AR STK	766 889	STK end fitting with eye	205
AS MS	785 109	Barrier rod, 2200 mm	142
AS SCHR M12 55	705 500	Bolted-type connector with threaded pin and separate hexagon nut, M12x55mm	81
AS SCHR M12 M12 40	705 504	Bolted-type connector with female thread M12, M12x40mm	81
AS SCHR M16 55 M12	705 510	Bolted-type connector for converting from M16/M12x55mm treaded pin	81
AS SCHR M16 65	750 500	Bolted-type connector with threaded pin and separate hexagon nut, M16x65mm	81
AS SCHW M12	336 020	Welding-type connector with female thread M12	81
AS SCHW M12 25	705 501	Welding-type connector with threaded pin, M12x25mm, St/galZn	81
AS SCHW M16	336 025	Welding-type connector with female thread M16	81
AS SCHW M16 30	755 501	Welding-type connector with threaded pin, M16x30mm, St/galZn	81
ASPS 110 132 16.7 L	767 565	Non-contact volt. detec. kit 110..132kV/16,7Hz, cat. L	169
ASPS 110 420 L	767 571	Non-contact volt. detec. kit 110..420kV/50Hz, cat. L	27
ASPS 110 420 S	767 572	Non-contact volt. detec. kit 110..420kV/50Hz, cat. S	27
ASPS 110 420 S L	767 573	Non-contact volt. detec. kit, 110..420kV/50Hz, cat. S/L	27
ASS 36 STK 30	766 325	Operating stick kit w. STK, Ø30mm, 2600mm, -36kV	51
ASS 36 STK 30 43	766 452	Operat. stick kit w. STK, Ø30/43mm, 2600mm, -36kV	51

Type	Part No.	Product	Page
ASSN 36 STK 30	766 326	Operating stick kit w. STK, Ø30mm, 2600mm, -36kV	49
ASSN 36 STK 43	766 453	Operating stick kit w. STK, Ø43mm, 3400mm, -36kV	49
AT IHS NS	785 490	Storage bag f. insulating gloves -1000V	155
AT PSA NS	785 425	Storage bag, -1000V	192
AT SPN II	766 543	Artificial leather bag for SPN	191
ATK 120 ..M NS	785 468	Insul. covering material, 1200mm x ..25m, -1000V	158
ATK 120 25M NS	785 467	Insul. covering material, 1200mm x 25m, -1000V	158
ATK 135 ..M NS	785 466	Insul. covering material, 1350mm x ..50m, -1000V	158
ATK 135 50M NS	785 465	Insul. covering material, 1350mm x 50m, -1000V	158
ATN 140 ..M NS	785 472	Insul. covering material, 1400mm x ..10m, -1000V, Chloroprene rubber	159
ATN 140 10M NS	785 471	Insul. covering material, 1400mm x 10m, -1000V, Chloroprene rubber	159
BB 245 MS	785 151	Round head brush f. cleaning kit TRS MS, Ø40mm, 390mm, -36kV	140
BEV BM HZ BDW K	751 193	Kit f. construction machines, lifting gear, maintenance vehicles, earthing device f. adjacent tracks	179
BEV MF LTE	751 192	Kit f. construction machines, lifting gear, maintenance vehicles, earthing device f. dedicated busbars	179
BEV MF SE K	751 191	Kit f. construction machines, lifting gear, maintenance vehicles, earthing device f. towers or railway tracks	179
BEV OL NPF K	750 210	Kit for overhead contact lines (non-profile-free), clamp with tommy bar	174
BEV OL NPF PKW K	750 196	Kit for overhead contact lines f. transport in motor vehicles (non-profile-free), clamp with tommy bar	174
BEV OL PF K	750 211	Kit for overhead contact lines (profile-free), clamp with tommy bar a. suspension hook	175
BEV OL PF PKW K	750 200	Kit for overhead contact lines f. transport in motor vehicles (profile-free), clamp with tommy bar	175
BEV OL PF V2 K	750 214	Kit for overhead contact lines (profile-free), clamp with tommy bar	175
BEV SVUL	750 213	Kit for supply lines, line feeders, bypass lines	176
BEV US OL ST	750 212	Kit for transformers at overhead contact line towers	176
BEV WHA ZVA	750 215	Kit for electric point and train pre-heating systems	178
BIT 8 SD KEV MS	785 272	Special bit f. MS screw driver set, 8mm	147
BIT 13 SD KEV MS	785 271	Special bit f. MS screw driver set, 13mm	147
BS SD KEV MS 1120	785 266	Operating stick with adjustable handle w. STK f. MS screw driver set, 1120mm	147
DGF EKV VI	745 921	Adjustable handle w. flexible shaft, Type VI	115
DHTM	785 180	Digital Hygrometer/Thermometer f. verifying the climatic conditions	142
DHTM T 615	785 181	Digital Hygrometer/Thermometer 5...95% r.F.f. Measuring range 0...+50°C	142
DP 40 40 B13 AL	525 001	Spring-loaded pressure plate Al, 40x40x6mm, 13mm	208
DP 50 50 B17 AL	525 002	Spring-loaded pressure plate Al, 50x50x8mm, 17mm	208
DR PHV	767 778	Sealing ring f. PHV basic device	209
DR PS PHE3	767 779	Sealing ring f. PHE III test prod	209
EAB RN 16 FS	790 150	Earth bushing with ting groove Ø16mm, with connection screw M12 f. 25..150mm <sup>2</sup>	100
EAB RN 16 SKN	790 160	Earth bushing with tommy bar	100
EAP 2 25 KKH HG	728 501	Earth connecting plate w. adjustable ball head cap, plastic handle a. 2 fixed ball points Ø25mm	184
EAP 2 25 MA US OL	728 502	Earth connecting plate f. tower w. 2 fixed ball points Ø25mm	184
EAP 25 SIT US OL	728 503	Earth connecting plate f. a fuse holder w. 1 fixed ball point Ø25mm	184
EAP 3 KFP 20 B13	728 320	Earth connecting plate w. hole 13mm a. 3 fixed ball points Ø20mm	78



## Type / Product Index

Type	Part No.	Product	Page	Type	Part No.	Product	Page
EAP 3 KFP 20 KKH	728 300	Earth connecting plate w. ball head cap a. 3 fixed ball points Ø20mm	82	EKV LK 50 4000	750 042	EaS-circuiting device 50 mm <sup>2</sup> , 4 m, w. conductor clamp a. universal earth clamp	179
EAP 3 KFP 25 B13	728 325	Earth connecting plate w. hole 13mm a. 3 fixed ball points Ø25mm	82	EKV R 50 8500	751 087	EaS-circuiting device 50 mm <sup>2</sup> , 8,5 m, w. clamp for railway tracks with ratchet	178
EAP 3 KFP 25 KKH	728 500	Earth connecting plate w. ball head cap a. 3 fixed ball points Ø25mm	82	EKV R 50 12000	751 127	EaS-circuiting device 50 mm <sup>2</sup> , 12 m, w. clamp for railway tracks with ratchet	178
EAP 3 RN 16 B13	728 316	Earth connecting plate w. hole 13mm a. 3 fixed earthing points w. ring groove Ø16mm	82	EKV R H 50 12000	751 122	EaS-circuiting device 50 mm <sup>2</sup> , 12 m, w. suspension hook a. w. clamp for railway tracks with ratchet	178
EAP 3 RN 16 EAB	728 520	Earth bushing a. 3 fixed earthing points w. ring groove Ø16mm	82	EKV ÜGK MB	745 107	EaS-circuiting device f. junction and fuse box 2xE14/E27 f. street lighting systems	121
EAS EK FM 12	775 621	Earth connector with wing nut M12 f. connecting piece PK1, 25-150mm <sup>2</sup>	100	EKV ÜGK MB S	745 105	EaS-circuiting device f. junction and fuse box 2xE14/E27 f. street lighting systems	121
EAS EK FM 16	775 631	Earth connector with wing nut M16 f. connecting piece PK1, 25-150mm <sup>2</sup>	100	EKV UK 50 4000	750 041	EaS-circuiting device 50 mm <sup>2</sup> , 4 m, w. universal clamp	179
EAS EK FS 12	775 626	Earth connector with wing bolt M12x15mm f. connecting piece PK1, 25-150mm <sup>2</sup>	100	EKV1+0 16	716 100	Single-pole EaS-circuiting cable, 16mm <sup>2</sup> , w. crimped cable lugs	88
EAS EK FS 16	775 636	Earth connector with wing bolt M16x15mm f. connecting piece PK1, 25-150mm <sup>2</sup>	100	EKV1+0 25	725 100	Single-pole EaS-circuiting cable, 25mm <sup>2</sup> , w. crimped cable lugs	88
EB 9V AL	767 713	9V E block battery Alkali-Mangan	209	EKV1+0 35	735 100	Single-pole EaS-circuiting cable, 35mm <sup>2</sup> , w. crimped cable lugs	88
EB 9V LI	767 712	9V E block battery Lithium	209	EKV1+0 50	750 100	Single-pole EaS-circuiting cable, 50mm <sup>2</sup> , w. crimped cable lugs	88
EFK FL30 SKN	792 030	Earth milling clamp w. tommy bar -30mm f. connecting piece PK1	101	EKV1+0 70	770 100	Single-pole EaS-circuiting cable, 70mm <sup>2</sup> , w. crimped cable lugs	88
EFK FL40 SKN	792 190	Earth milling clamp w. tommy bar -40mm f. connecting piece PK1	101	EKV1+0 95	795 100	Single-pole EaS-circuiting cable, 95mm <sup>2</sup> , w. crimped cable lugs	88
EFP 16 RN M12	790 250	Earthing fixed point w. ring groove Ø16mm a. M12	80	EKV1+0 120	712 100	Single-pole EaS-circuiting cable, 120mm <sup>2</sup> , w. crimped cable lugs	88
EFP 16 RN M12 35 SSM	790 251	Earthing fixed point w. ring groove Ø16mm w. threaded pin a. nut M12x35mm	80	EKV1+0 150	715 100	Single-pole EaS-circuiting cable, 150mm <sup>2</sup> , w. crimped cable lugs	88
EFP 16 RN M16	790 260	Earthing fixed point w. ring groove Ø16mm a. M16	80	EKV2 50 KKH 600 1800	751 150	Two-pole EaS-circuiting cable, SK, Ø25mm, 50/50mm <sup>2</sup>	179
EFP 16 RN M16 45 SSM	790 261	Earthing fixed point w. ring groove Ø16mm a. threaded pin a. nut M16x45mm	80	EKV2+0 16 G	716 200	Two-pole EaS-circuiting cable, 16mm <sup>2</sup> , w. crimped cable lugs	88
EFS L 127	767 576	E field sensor f. overhead lines, 127mm	199	EKV2+0 25 G	725 200	Two-pole EaS-circuiting cable, 25mm <sup>2</sup> , w. crimped cable lugs	88
EFS S 167	767 577	E field sensor f. outdoor switching stations, 167mm	199	EKV2+0 35 G	735 200	Two-pole EaS-circuiting cable, 35mm <sup>2</sup> , w. crimped cable lugs	88
EG 00 4A VI	745 922	VI earthing handle f. installing earthing cartridges a. connecting EaS-devices to earthing cartridges	115	EKV2+0 50 G	750 202	Two-pole EaS-circuiting cable, 50mm <sup>2</sup> , w. crimped cable lugs	88
EG SK STK 400	745 415	earthing handle w. STK, SK, -1000V AC/-3000V DC	122	EKV2+0 70 G	770 200	Two-pole EaS-circuiting cable, 70mm <sup>2</sup> , w. crimped cable lugs	88
EG SQ STK 400	745 414	earthing handle w. STK, SQ, -1000V AC/-3000V DC	122	EKV2+0 95 G	795 200	Two-pole EaS-circuiting cable, 95mm <sup>2</sup> , w. crimped cable lugs	88
EG TI EKV	745 400	TI earthing handle f. installing earthing cartridges a. connecting EaS-devices to earthing cartridges	118	EKV2+0 120 G	712 200	Two-pole EaS-circuiting cable, 120mm <sup>2</sup> , w. crimped cable lugs	88
EH1 PK FV ZK	784 461	Single-pole coupling aid w. ZK, f. spring-loaded clamp for overhead lines without shaft	95	EKV2+0 150 G	715 200	Two-pole EaS-circuiting cable, 150mm <sup>2</sup> , w. crimped cable lugs	88
EH3 PK FV SQL	784 463	3-pole coupling aid, SQ, f. spring-loaded clamp for overhead lines without shaft	95	EKV3 16TI EK	745 363	TI three-pole EaS-circuiting cable, 16mm <sup>2</sup> , w. M10 connection screw	117
EHH BEV OL	740 124	Suspension hook f. earthing cables	179	EKV3 16TI HK	745 358	TI three-pole EaS-circuiting cable, 16mm <sup>2</sup> , w. M10 connection screw	117
EK FL20 FS	745 502	Earthing clamp w. wing bolt	118	EKV3 16VI EK	745 340	VI three-pole EaS-circuiting cable, 16mm <sup>2</sup> , f. phase T pin	115
EK I FL20 DGF	745 602	Earth clamp w. flexible adjustable handle, to be connected to the earth cable end of EaS-devices	118	EKV3 25BS ZK	745 375	Three-pole EaS-circuiting cable, 25mm <sup>2</sup> , w. clamps	119
EKS 50 BEV 4M	751 040	EaS-circuiting cable w. connect. pc. PK2, 50mm <sup>2</sup> , 4m	179	EKV3 25TI DG	745 345	TI three-pole EaS-circuiting cable, 25mm <sup>2</sup> , w. M10 connection screw	117
EKS 50 BEV 8.5M	751 085	EaS-circuiting cable w. connect. pc. PK2, 50mm <sup>2</sup> , 8,5m	179	EKV3 25TI HK	745 359	TI three-pole EaS-circuiting cable, 25mm <sup>2</sup> , w. M10 connection screw	117
EKS 50 BEV 12M	751 120	EaS-circuiting cable w. connect. pc. PK2, 50mm <sup>2</sup> , 12m	179	EKV3 25VI DG	745 325	VI three-pole EaS-circuiting cable, 25mm <sup>2</sup> , f. phase T pin	115
EKS 50 BEV 13M	751 130	EaS-circuiting cable w. connect. pc. PK2, 50mm <sup>2</sup> , 13m	179	EKV3 25VI EK	745 326	VI three-pole EaS-circuiting cable, 25mm <sup>2</sup> , f. phase T pin	115
EKS 50 BEV 14M	751 140	EaS-circuiting cable w. connect. pc. PK2, 50mm <sup>2</sup> , 14m	179	EKV3 35BS ZK	745 376	Three-pole EaS-circuiting cable, 35mm <sup>2</sup> , w. clamps	119
EKS TI 2F KVS SBK	745 500	TI EaS-circuiting kit in sheet metal case	116	EKV3 25IS ZK	745 370	Three-pole EaS-circuiting cable, 25mm <sup>2</sup> , w. clamps	119
EKS TI KVS SBK	766 302	TI EaS-circuiting kit in plastic case	116				
EKS VI 2F KVS KK	745 903	VI EaS-circuiting kit in plastic case	114				
EKS VI 2F KVS SBK	745 901	VI f. EaS-circuiting kit in sheet metal case	114				
EKV K 50 8500	751 086	EaS-circuiting device 50 mm <sup>2</sup> , 8,5 m, w. clamp for railway tracks with tommy bar	178				
EKV K 50 12000	751 126	EaS-circuiting device 50 mm <sup>2</sup> , 12 m, w. clamp for railway tracks with tommy bar	178				
EKV K H 50 12000	751 121	EaS-circuiting device 50 mm <sup>2</sup> , 12 m, w. suspension hook a. w. clamp for railway tracks with tommy bar	174				



Type	Part No.	Product	Page
EKV3 35IS ZK	745 371	Three-pole EaS-circuiting cable, 35mm <sup>2</sup> , w. clamps	119
EKV3 35TI DG	745 346	TI three-pole EaS-circuiting cable, 35mm <sup>2</sup> , w. M10 connection screw	117
EKV3 35TI HK	745 360	TI three-pole EaS-circuiting cable, 35mm <sup>2</sup> , w. M10 connection screw	117
EKV3 35VI DG	745 335	VI three-pole EaS-circuiting cable, 35mm <sup>2</sup> , f. phase T pin	115
EKV3 35VI EK	745 336	VI three-pole EaS-circuiting cable, 35mm <sup>2</sup> , f. phase T pin	115
EKV3 50IS ZK	745 372	Three-pole EaS-circuiting cable, 50mm <sup>2</sup> , w. clamps	119
EKV3 NH00 TI	745 365	TI three-pole EaS-circuiting cable, 16mm <sup>2</sup> , w. earthing cartridges of size NH00	117
EKV3+0 16 G	716 300	Three-pole EaS-circuiting cable, 16mm <sup>2</sup> , w. crimped cable lugs	88
EKV3+0 25 G	725 300	Three-pole EaS-circuiting cable, 25mm <sup>2</sup> , w. crimped cable lugs	88
EKV3+0 35 G	735 300	Three-pole EaS-circuiting cable, 35mm <sup>2</sup> , w. crimped cable lugs	88
EKV3+0 50 G	750 300	Three-pole EaS-circuiting cable, 50mm <sup>2</sup> , w. crimped cable lugs	88
EKV3+0 50 R	750 301	Three-pole EaS-circuiting cable, 50mm <sup>2</sup> , w. crimped cable lugs, reduced cable cross-section	88
EKV3+0 70 G	770 300	Three-pole EaS-circuiting cable, 70mm <sup>2</sup> , w. crimped cable lugs	88
EKV3+0 70 R	770 301	Three-pole EaS-circuiting cable, 50mm <sup>2</sup> , w. crimped cable lugs, reduced cable cross-section	88
EKV3+0 95 G	795 300	Three-pole EaS-circuiting cable, 95mm <sup>2</sup> , w. crimped cable lugs	88
EKV3+0 95 R	795 301	Three-pole EaS-circuiting cable, 95mm <sup>2</sup> , w. crimped cable lugs, reduced cable cross-section	88
EKV3+0 120 G	712 300	Three-pole EaS-circuiting cable, 120mm <sup>2</sup> , w. crimped cable lugs	88
EKV3+0 120 R	712 301	Three-pole EaS-circuiting cable, 120mm <sup>2</sup> , w. crimped cable lugs, reduced cable cross-section	88
EKV3+0 150 G	715 300	Three-pole EaS-circuiting cable, 150mm <sup>2</sup> , w. crimped cable lugs	88
EKV3+0 150 R	715 301	Three-pole EaS-circuiting cable, 150mm <sup>2</sup> , w. crimped cable lugs, reduced cable cross-section	88
EKV4u0 16 G	716 401	Four-pole EaS-circuiting cable, 16mm <sup>2</sup> , w. crimped cable lugs	89
EKV4u0 25 G	725 401	Four-pole EaS-circuiting cable, 25mm <sup>2</sup> , w. crimped cable lugs	89
EKV4u0 35 G	735 401	Four-pole EaS-circuiting cable, 35mm <sup>2</sup> , w. crimped cable lugs	89
EKV4u0 50 G	750 401	Four-pole EaS-circuiting cable, 50mm <sup>2</sup> , w. crimped cable lugs	89
EKV4u0 70 G	770 401	Four-pole EaS-circuiting cable, 70mm <sup>2</sup> , w. crimped cable lugs	89
EKV4u0 95 G	795 401	Four-pole EaS-circuiting cable, 95mm <sup>2</sup> , w. crimped cable lugs	89
EKV4u0 120 G	712 401	Four-pole EaS-circuiting cable, 120mm <sup>2</sup> , w. crimped cable lugs	89
EKV4u0 150 G	715 401	Four-pole EaS-circuiting cable, 150mm <sup>2</sup> , w. crimped cable lugs	89
EKV5+0 16 G	716 500	Five-pole EaS-circuiting cable, 16mm <sup>2</sup> , w. crimped cable lugs	89
EKV5+0 25 G	725 500	Five-pole EaS-circuiting cable, 25mm <sup>2</sup> , w. crimped cable lugs	89
EKV5+0 35 G	735 500	Five-pole EaS-circuiting cable, 35mm <sup>2</sup> , w. crimped cable lugs	89
EKV5+0 50 G	750 510	Five-pole EaS-circuiting cable, 50mm <sup>2</sup> , w. crimped cable lugs	89
EKV5+0 70 G	770 500	Five-pole EaS-circuiting cable, 70mm <sup>2</sup> , w. crimped cable lugs	89

Type	Part No.	Product	Page
EKV5+0 95 G	795 500	Five-pole EaS-circuiting cable, 95mm <sup>2</sup> , w. crimped cable lugs	89
EKV5+0 120 G	712 500	Five-pole EaS-circuiting cable, 120mm <sup>2</sup> , w. crimped cable lugs	89
EKV5+0 150 G	715 500	Five-pole EaS-circuiting cable, 150mm <sup>2</sup> , w. crimped cable lugs	89
EL M8 G PHE	766 924	Fork-shaped electrode f. PHE/PHV, M8, 69mm	196
EL M8 H PHE	766 923	Hook-shaped electr. f. PHE/PHV, M8, up to Ø22mm	196
EL M8 MAG PHE PHV	766 915	Eaton Holec Magnefix electr. f. PHE/PHV, M8, 3..15kV	196
EL M8 S PHE PHV	766 925	Pin-shaped electrode f. PHE/PHV, M8/M6, Ø4mm, from 3kV	196
EL M8 SZ PHE PHV	766 913	Onion-shaped electrode f. PHE/PHV, M8, from 3kV	196
EL M8 V PHE PHV	766 927	V-shaped electr. f. PHE/PHV, M8, 22mm, from 3kV	196
EP 25 K NS	785 595	Spare brush f. cleaning heads Ø25mm f. TRS NS, -1000V	134
EP 25 L MS	785 224	Spare brush f. cleaning heads Ø40mm f. TRS MS, -36kV	142
EP 25 L NS	785 596	Spare brush f. cleaning heads Ø40mm f. TRS NS, -1000V	134
EP NH00 TI M10	745 302	TI earthing cartridge w. M10, size NH00	117
EP NH00 VI TA	745 905	Earthing cartridge, size NH00	115
EP NH1 3 TI GL M10	745 017	TI earthing cartridge w. M10 a. grip lugs, size NH 1..3	117
EP NH1 3 TI M10	745 018	Earthing cartridge, size NH 1..3	117
EP NH1 3 VI TA	745 910	VI earthing cartridge w. T connection, size NH 1..3	115
EP NH4A TI M10	745 016	TI earthing cartridge w. M10, size NH 4a	117
EP NH4A VI TA	745 915	Earthing cartridge, size NH 4a	115
ES 3P FL ER	799 009	Earthing kit for overhead line systems	97
ES SK 1000	761 010	Earthing stick, SK, 1000mm	103
ES SK 1500	761 015	Earthing stick, SK, 1500mm	103
ES SK STK 1000	761 001	Earthing stick w. STK, SK, 1000mm	103
ES SK STK 2000	761 003	Erdungsstange w. STK, SK, 2000mm	103
ES SQ 1000	761 011	Earthing stick, SQ, 1000mm	103
ES SQ 1500	761 016	Earthing stick, SQ, 1500mm	103
ES SQ STK 1000	761 002	Earthing stick w. STK, SQ, 1000mm	103
ES SQ STK 2000	761 004	Earthing stick w. STK, SQ, 2000mm	103
ES SQL STK 43 1045	766 074	Earthing stick w. STK a. cone coupling SQL, 1045mm	201
ES YM2 16	716 001	Earthing cable YM2, 16mm <sup>2</sup>	89
ES YM2 25	725 001	Earthing cable YM2, 25mm <sup>2</sup>	89
ES YM2 35	735 001	Earthing cable YM2, 35mm <sup>2</sup>	89
ES YM2 50	750 001	Earthing cable YM2, 50mm <sup>2</sup>	89
ES YM2 70	770 001	Earthing cable YM2, 70mm <sup>2</sup>	89
ES YM2 95	795 001	Earthing cable YM2, 95mm <sup>2</sup>	89
ES YM2 120	712 001	Earthing cable YM2, 120mm <sup>2</sup>	89
ES YM2 150	715 001	Earthing cable YM2, 150mm <sup>2</sup>	89
ESE E27 KBI M10	745 203	Screw-in earthing insert, size E27 w. conductive thread	118
ESE E27 TI M10	745 201	Screw-in earthing insert, size E27 w. insulated thread	118
ESE E33 KBI M10	745 204	Screw-in earthing insert, size E33 w. conductive thread	118
ESE E33 TI M10	745 202	Screw-in earthing insert, size E33 w. insulated thread	118
ESS 3P M10 FM	799 019	Three-pole earthing busbar	97
ESH 1000 S B	785 743	Safety helmet, blue, size 51-63cm, -1000V	151
ESH 1000 S O	785 742	Safety helmet, orange, size 51-63cm, -1000V	151
ESH 1000 S R	785 744	Safety helmet, red, size 51-63cm, -1000V	151
ESH 1000 S W	785 741	Safety helmet, white, size 51-63cm, -1000V	151
ESH 1000 S Y	785 740	Safety helmet, yellow, size 51-63cm, -1000V	151
ESS STK 43	766 450	Earthing stick kit w. STK, Ø43mm, 4000mm, -36kV	51
ESSN STK 43	766 451	Earthing stick kit w. STK, Ø43mm, 4000mm, -36kV	49
EST ES 1500	769 505	Earthing stick – end fitting, 1500mm	108
EST KS SQL 1500	769 503	Earthing stick – top section, SQL, 1500mm	108
EST SK STK 920	761 070	Earthing stick f. SK w. STK, 920mm	104

## Type / Product Index

Type	Part No.	Product	Page	Type	Part No.	Product	Page
EST SQ STK 920	761 075	Earthing stick f. SQ w. STK, 920mm	104	HSA194 110 420 16.7	767 542	Non-contact voltage detector HSA 194, 110..420kV/16.7Hz	168
EST SQL RW 4915 TA	769 506	Six-part earthing stick kit f. SQL, 4915mm, w. bag	182	HSA205 U 1 420 STK	767 552	Non-contact voltage detector HSA 205, switchable 1..30/30..220/110..420kV/50Hz	28
EST ZS 1500	769 504	Earthing stick – intermediate section, 1500mm	108	HV 3HH	700 015	Storage devices f. 3 HH fuses	207
ESTC SQL 4000	769 400	Telescopic earthing stick w. cone coupling SQL, 2170-4000mm	106	HV 3HH ET	700 005	Storage devices f. 3 HH fuses, single parts	207
ESTC SQL 5000	769 500	Telescopic earthing stick w. cone coupling SQL, 2670-5000mm	106	HV 3HH SZ	700 014	Storage devices f. 3 HH fuses a. a fuse tong	207
ESTC SQL H RW 5000	769 508	Telescopic earthing stick w. cone coupling SQL a. cable entry a. hook, 2670-5000mm	182	HV 3HH SZ ET	700 004	Storage devices f. 3 HH fuses a. a fuse tong, single parts	207
ESTC SQL RW 3500	769 352	Telescopic earthing stick w. cone coupling SQL a. locking mechanism, 1920-3500mm	182	HV EKV ES30	700 000	Storage devices f. EaS-circuiting devices a. stick Ø30mm	207
ESTC SQL RW 5000	769 502	Telescopic earthing stick w. cone coupling SQL a. locking mechanism, 2670-5000mm	182	HV EKV ES30 1500	700 003	Storage devices f. EaS-circuiting devices a. stick Ø30mm, 1500mm	207
ESTC SQL STK 3000	769 300	Telescopic earthing stick w. cone coupling SQL a. STK, 1670-3000mm	106	HV EKV ES40	700 002	Storage devices f. EaS-circuiting devices a. stick Ø40mm	207
EV EH 1725 EK	758 015	Single-pole earthing and discharge device w. earth clamp w. tommy bar, 1725mm	126	HV P ST D24	700 006	Storage devices f. voltage detector a. stick Ø24mm	206
EV TES 465 EK	758 020	Single-pole earthing and discharge device w. handle a. earth clamp w. wing bolt, 465mm	125	HV P ST D30	700 007	Storage devices f. voltage detector a. stick Ø30mm	206
EV TES 465 EZ	758 021	Single-pole earthing and discharge device w. handle a. spring-loaded earth clamp, 465mm	125	HV P ST D40 45	700 008	Storage devices f. voltage detector, fuse tong a. stick Ø40..45mm	206
EV TES 465 KS10	758 022	Single-pole earthing and discharge device w. handle earth cable lug, 10mm <sup>2</sup> , 1-pol., 465mm	125	HV STK 30 710	766 335	Extension handle w. STK, 710mm	204
EV TES STK 1500 KS	758 025	Single-pole earthing and discharge device w. plug-in coupling a. earth cable lug, 1500mm, cable length 3500mm	127	HV STK 43 1045	766 076	Extension handle w. STK, Ø43mm, 1045mm	204
EV TS 2000 EK	758 001	Single-pole earthing and discharge device w. earth clamp w. wing bolt, 2050mm	126	HV STK 43 1280	766 466	Extension handle w. STK, Ø43 mm, 1280mm	204
EV TS 2000 EZ	758 003	Single-pole earthing and discharge device w. spring-loaded earth clamp, 2050mm	126	HV STK 43 2350	766 073	Extension handle w. STK, Ø43mm, 2350mm	204
FD 110 MS	785 221	Flat cleaning head f. TRS MS, 110x260mm, -36kV	140	HV STK 43 910	766 456	Extension handle w. STK, Ø43mm, 910mm	204
FD 210 MS	785 223	Flat cleaning head f. TRS MS, 210x255mm, -36kV	140	HV STK 43 975	766 077	Extension handle w. STK, Ø43mm, 975mm	204
FD 35 NS	785 541	Flat cleaning head f. TRS NS, Ø25mm, 35mm, -1000V	133	HV STK 710	766 335	Extension handle w. STK, 710mm, 30kV	143
FD 35 P NS	785 590	Flat cleaning head w. brush f. TRS NS, Ø25mm, 35mm, -1000V	133	HV STK RW 43 1045	766 078	Extension handle w. STK, rot/weiß, Ø43mm, 1045mm	204
FD 35 S MS	785 551	Flat cleaning head f. TRS MS, 35mm, 200mm, -36kV	140	HV STK RW 43 975	766 079	Extension handle w. STK, rot/weiß Ø43mm, 975mm	204
FD 35 S NS	785 542	Flat cleaning head, camfered f. TRS NS, Ø25mm, 35mm, -1000V	133	IE UF LF 150	785 440	Insulating insert for buried beacons, Ø150 mm	157
FD 35 W P MS	785 552	Flat cleaning head, angled w. brush f. TRS MS, 35mm, 250mm, -36kV	140	IE UF LF 200	785 441	Insulating insert for buried beacons, Ø200 mm	157
FD 35 W P NS	785 591	Flat cleaning head, angled w. brush f. TRS NS, Ø25mm, 35mm, -1000V	133	IHS 0 M 9 NS	785 493	Insulating gloves cl.0 cat.M, size 9, -1000V	155
FD 55 NS	785 540	Flat cleaning head f. TRS NS, Ø40mm, 55mm, -1000V	133	IHS 0 M 10 NS	785 494	Insulating gloves cl.0 cat.M, size 10, -1000V	155
FD 60 MS	785 220	Flat cleaning head f. TRS MS, 60mm, 260mm, -36kV	140	IHS 00 M 9 NS	785 491	Insulating gloves cl.00 cat.M, size 9, -500V	155
FEK 4 15 TS FSQ	784 755	Earth clamp f. overhead contact lines, f. Ø4-15mm, w. flexible threaded T pin shaft	180	IHS 00 M 10 NS	785 492	Insulating gloves cl.00 cat.M, size 10, -500V	155
FR A12 V2A	524 912	Spring washers DIN 128, A12, StSt	208	IHS 00 RC 9 NS	785 495	Insulating gloves cl.00 cat.RC, size 9, -500V	155
FR A16 V2A	524 913	Spring washers DIN 128, A16, StSt	208	IHS 00 RC 10 NS	785 496	Insulated gloves cl.00 cat.RC, size 10, -500V	155
FRS ZK MS	785 940	MS damp cleaning kit w. ZK, -36kV	137	IMG SAN 1M ..M	785 458	Insulated mats, 4,5mm x 1m x ..10m	159
FSG PHE	767 776	Protective rubber f. PHE	209	IMG SAN 1M 10M	785 459	Insulated mats, 4,5mm x 1m x 10m	159
FSG PHG2 PHV	767 777	Protective rubber f. PHV/PHG II	209	IMG SI ..M NS	785 456	Insulated rubber mats f. insulating the operating location, 3mm x 1m x ..10m, -1000V	159
FWD 35 P NS	785 592	90° angled flat cleaning head w. brush f. TRS NS, Ø25mm, 35mm, -1000V	143	IMG SI 1M NS	785 455	Insulated rubber mats f. insulating the operating location, 3mm x 1m x 1m, -1000V	159
GL 3.5V 0.2A E10	766 605	Small electric bulb, 3.5 ... 3.8V, 0.2A, E10	205	IMG SI 10M NS	785 457	Insulated rubber mats f. insulating the operating location, 3mm x 1m x 10m, -1000V	159
H STK 43 800	766 120	Handle w. STK, Ø43mm, 800mm	204	INFL MS	785 261	Insulating refilling lance, MS, -36kV	145
HISC 1400	785 310	Industrial vacuum cleaner 1400W	143	IS 123 SK STK 2000	766 122	Insulating stick w. STK, SK, M12, 2000mm, 123kV	55
HK 8 NS	785 648	Hook, Ø8mm, size 130/72mm, -1000V	159	IS 123 SQ STK 2000	766 322	Insulating stick w. STK, SQ, 2000mm, 123kV	55
HRB 120 MS	785 140	Half-round brush f. TRS MS, Ø120mm, -36kV	140	IS 25 ZK 2885	766 048	Insulating stick w. gear coupling, 2885mm, 7.5kV DC/25kV AC	203
HRB 190 MS	785 150	Half-round brush f. TRS MS, Ø190mm, -36kV	140	IS 25 ZK RK 3160	766 340	Insulating stick kit for cleaning the windscreen of electric locomotives, 3160mm, 7.5kV DC/25kV AC	185
				IS 36 SK 1000	766 001	Insulating stick, SK, M12, 1000mm, 36kV	55
				IS 36 SK 1500	766 002	Insulating stick, SK, M12, 1500mm, 36kV	55
				IS 36 SK STK 1000	766 100	Insulating stick w. STK, M12, SK, 1000mm, 36kV	55
				IS 36 SQ 1000	766 311	Insulating stick, SQ, 1028mm, 36kV	55
				IS 36 SQ 1500	766 315	Insulating stick, SQ, 1528mm, 36kV	55
				IS 36 SQ STK 1000	766 301	Insulating stick w. STK, SQ, M12, 1000mm, 36kV	55
				IS 36 STK 30 1280	766 363	Insulating stick w. STK, Ø30mm, 1280mm, 36kV	202

Type	Part No.	Product	Page
IS 36 STK 43 1280	766 463	Insulating stick w. STK, Ø43mm, 1280mm, 36kV/50Hz	202
IS 36 ZK STK 1300	785 325	Insulating stick w. handle a. ZK f. FRS MS, -36kV	139
IS M12 STK 30 720	766 072	Insulating stick f. PHE w. M12 u. STK, 720mm	202
IS M12 STK 30 1060	766 075	Insulating stick f. PHE w. M12 u. STK, 1060mm	202
IS M12 STK 640	766 331	Insulating stick w. M12 a. STK, 640mm	202
IS T 36 ZK STK 1300	785 315	Insulating stick w. handle a. ZK, f. FRS MS,-36kV	139
IS ZK STK 670	766 368	Insulating stick w. ZK a. STK, 670mm	17
IS ZK STK HS 670	766 369	Insulating stick w. ZK a. STK w. hand strap, 670mm	202
ISMTC N 36 ZK 10600	766 037	Telescopic insulating stick w. ZK, support a. scale f. measuring, 10600mm, 36kV	17
ISN 36 SK 1000	766 210	Insulating stick, SK, Ø30mm, 1000mm, 36kV	53
ISN 36 SK 1500	766 215	Insulating stick, SK, Ø30mm, 1500mm, 36kV	53
ISN 36 SK STK 1000	766 111	Insulating stick w. STK, SK, Ø30mm, 1000mm, 36kV	53
ISN 123 SK STK 2500	766 222	Insulating stick w. STK, SK, Ø30mm, 2500mm, 123kV	53
ISN 36 SQ 1000	766 211	Insulating stick, SQ, Ø30mm, 1000mm, 36kV	53
ISN 36 SQ 1500	766 216	Insulating stick, SQ, Ø30mm, 1500mm, 36kV	53
ISN 36 SQ STK 1000	766 310	Insulating stick w. STK, SQ, Ø30mm, 1000mm, 36kV	53
ISN 123 SQ STK 2500	766 332	Insulating stick w. STK, SQ, Ø30mm, 2500mm, 123kV	53
ISN 36 STK 30 1280	766 367	Insulating stick w. STK, Ø30mm, 1280mm, 36kV	202
ISN 36 STK 43 1280	766 468	Insulating stick w. STK, Ø43mm, 1280mm, 36kV/50Hz	202
ISP 135 ZK MS	785 190	MS insulating mirror w. ZK, Ø135mm	142
ISP 36 PVC A1...	763 211	Insulating protective shutters, design A1, rigid PVC	64
ISP 36 PVC A2...	763 221	Insulating protective shutters, design A2, rigid PVC	64
ISP 36 PVC A3...	763 231	Insulating protective shutters, design A3, rigid PVC	65
ISP 36 PVC A4...	763 241	Insulating protective shutters, design A4, rigid PVC	65
ISV 220 ZK MS	785 316	Insulating stick extension f. FRS MS m. ZK, 220mm	139
ISV 320 ZK MS	785 317	Insulating stick extension f. FRS MS m. ZK, 320mm	139
ISV 36 STK 30 910	766 356	Insul. stick extension w. STK, Ø30mm, 910mm, 36kV	204
ISV 36 STK 30 1280	766 366	Insulating stick extension w. STK, Ø30mm, 1280mm	204
ISV 420 ZK MS	785 318	Insulating stick extension f. FRS MS w. ZK, 420mm	139
ISV 820 ZK MS	785 319	Insulating stick extension f. FRS MS w. ZK, 820mm	139
IT M12 STK 30 700	766 114	Insulating element w. M12 a. STK, Ø30mm, 700mm	203
IT M12 STK 30 1150	766 115	Insulating element w. M12 a. STK, Ø30mm, 1150mm	203
IT STK 43 1280	766 128	Insulating element w. STK, Ø43mm, 1280mm	203
IT ZK30 STK 30 360	766 358	Adapter w. ZK a. STK, 30° angled, Ø30mm, 360mm	203
IV VK13 SW17 1000	785 445	Extension w. 13mm square, SW17, 1000mm	157
IW 17.5 890 650 180	785 408	Insulated platform, 890x650x180mm, 17.5kV	157
KFP 20 M12	754 200	Fixed ball point Ø20mm, straight w. female thread M12	77
KFP 20 M12 35 SSM	754 235	Fixed ball point Ø20mm, straight w. threaded pin a. nut M12x35mm	77
KFP 20 M16	754 600	Fixed ball point Ø20mm, straight w. female thread M16	77
KFP 20 M16 45 SSM	754 645	Fixed ball point Ø20mm, straight w. threaded pin a. nut M16x45mm	77
KFP 20 RL 10	720 010	Fixed ball point Ø20mm, f. round conductor Ø10mm	79
KFP 20 RL 12	720 012	Fixed ball point Ø20mm, f. round conductor Ø12mm	79
KFP 20 RL 14	720 014	Fixed ball point Ø20mm, f. round conductor Ø14mm	79
KFP 20 RL 16	720 016	Fixed ball point Ø20mm, f. round conductor Ø16mm	79
KFP 20 RL 18	720 018	Fixed ball point Ø20mm, f. round conductor Ø18mm	79
KFP 20 RL 20	720 020	Fixed ball point Ø20mm, f. round conductor Ø20mm	79
KFP 20 S AL 12	706 300	Fixed ball point Ø20mm, angled w. terminal lug 45x30x9mm	76
KFP 20 W45 M12	706 200	Fixed ball point Ø20mm, 45° angled w. M12	78
KFP 20 W45 M12 35SSM	706 235	Fixed ball point Ø20mm, 45° angled w. threaded pin a. nut M12x35mm	77
KFP 20 W45 M16	706 600	Fixed ball point Ø20mm, 45° angled w. M16	78
KFP 20 W45 M16 45SSM	706 645	Fixed ball point Ø20mm, 45° angled w. threaded pin a. nut M16x45mm	77
KFP 20 W90 M12	707 200	Fixed ball point Ø20mm, 90° angled w. M12	78

Type	Part No.	Product	Page
KFP 20 W90 M12 35SSM	707 235	Fixed ball point Ø20mm, 90° angled w. threaded pin a. nut M12x35mm	78
KFP 20 W90 M16	707 600	Fixed ball point Ø20mm, 90° angled w. M16	78
KFP 20 W90 M16 45SSM	707 645	Fixed ball point Ø20mm, 90° angled w. threaded pin a. nut M16x45mm	78
KFP 25 M12	755 200	Fixed ball point Ø25mm, straight w. M12	77
KFP 25 M12 25 SSM	755 225	Fixed ball point Ø25mm, straight w. threaded pin a. nut M12x25mm	77
KFP 25 M12 35 SKM	755 627	Fixed ball point Ø25mm, straight w. threaded pin a. nut a. washer M12x35mm	183
KFP 25 M12 45 SSM	755 245	Fixed ball point Ø25mm, straight w. threaded pin a. nut M12x45mm	77
KFP 25 M16	755 600	Fixed ball point Ø25mm, straight w. M16	77
KFP 25 M16 25	755 636	Fixed ball point Ø25mm, straight w. threaded pin M16x26mm	183
KFP 25 M16 25 SKM	755 626	Fixed ball point Ø25mm, straight w. threaded pin a. nut a. washer M16x26mm	183
KFP 25 M16 45 SKM	755 646	Fixed ball point Ø25mm	183
KFP 25 M16 45 SSM	755 645	Fixed ball point Ø25mm, straight w. threaded pin a. nut M16x45mm	77
KFP 25 RL 10	725 010	Fixed ball point Ø25mm, f. round conductor Ø10mm	79
KFP 25 RL 12	725 012	Fixed ball point Ø25mm, f. round conductor Ø12mm	79
KFP 25 RL 14	725 014	Fixed ball point Ø25mm, f. round conductor Ø14mm	79
KFP 25 RL 16	725 016	Fixed ball point Ø25mm, f. round conductor Ø16mm	79
KFP 25 RL 18	725 018	Fixed ball point Ø25mm, f. round conductor Ø18mm	79
KFP 25 RL 20	725 020	Fixed ball point Ø25mm, f. round conductor Ø20mm	79
KFP 25 S AL 12	756 300	Fixed ball point Ø25mm, angled w. terminal lug 50x30x9mm	76
KFP 25 W45 M12	756 200	Fixed ball point Ø25mm, 45° angled w. M12	78
KFP 25 W45 M12 45SSM	756 245	Fixed ball point Ø25mm, 45° angled w. threaded pin a. nut M12x45mm	77
KFP 25 W45 M16	756 600	Fixed ball point Ø25mm, 45° angled w. M16	78
KFP 25 W45 M16 45SSM	756 645	Fixed ball point Ø25mm, 45° angled w. threaded pin a. nut M16x45mm	77
KFP 25 W90 M12	757 200	Fixed ball point Ø25mm, 90° angled w. M12	78
KFP 25 W90 M12 45SSM	757 245	Fixed ball point Ø25mm, 90° angled w. threaded pin a. nut M12x35mm	78
KFP 25 W90 M16	757 600	Fixed ball point Ø25mm, 90° angled w. M16	78
KFP 25 W90 M16 45SSM	757 645	Fixed ball point Ø25mm, 90° angled w. threaded pin a. nut M16x45mm	78
KK 35 NS	785 647	Clip f. covering material, -35mm, -1000V	159
KK 56 41 17 EK HK	745 953	Empty plastic case f. EaS kit a. earthing stick, 565x410x170mm	190
KK 56 41 17 EK VI TI	745 952	Empty plastic case f. EaS kit f. KVS, 565x410x170mm	190
KK TA 0 24 SK10	745 503	Spring-loaded compact clamp	115
KKH 20 D SK	772 330	Adjustable ball head cap Ø20mm, SK	91
KKH 20 D SQ	772 331	Adjustable ball head cap Ø20mm, SQ	91
KKH 20 FS	772 312	Rigid ball head cap Ø20mm, w. wing bolt	99
KKH 20 HG	772 313	Rigid ball head cap Ø20mm, w. plastic handle	99
KKH 20 SK	772 310	Rigid ball head cap Ø20mm, w. SK	91
KKH 20 SQ	772 311	Rigid ball head cap Ø20mm, w. SQ	91
KKH 20 SQL	772 314	Rigid ball head cap Ø20mm, w. SQL	96
KKH 25 D SK	772 340	Adjustable ball head cap Ø25mm, SK	91
KKH 25 D SQ	772 341	Adjustable ball head cap Ø25mm, SQ	91
KKH 25 FS	772 322	Rigid ball head cap Ø25mm, w. wing bolt	99
KKH 25 HG	772 323	Rigid ball head cap Ø25mm, w. plastic handle	99
KKH 25 SK	772 320	Rigid ball head cap Ø25mm, w. SK	91
KKH 25 SQ	772 321	Rigid ball head cap Ø25mm, w. SQ	91
KKH 25 SQL	772 324	Rigid ball head cap Ø25mm, w. SQL	96
KKL B NFG MS	785 299	Empty plastic case f. reservoirs f. NFG MS	145
KKL DCA	767 107	Empty plastic case f. DEHNcap, 395x295x105mm	190



## Type / Product Index

Type	Part No.	Product	Page	Type	Part No.	Product	Page
KKL EKS VI KVS	745 902	Empty plastic case f. EaS kit VI f. KVS	190	PFP 49 70 AL 60 126	731 015	PFP f. conductor Ø48-70mm, Al, width 126x60mm	83
KKL EKV ÜGK MB	745 106	Empty plastic case f. EaS-circuiting device f. street lighting systems	190	PHE 3 S	767 403	PHE voltage detector, 3kV/50Hz, cat. S	25
KKL FRS ZK MS	785 229	Empty plastic case f. FRS MS, 850x300x200mm	139	PHE 3 10 S	767 410	PHE voltage detector, 3..10kV/50Hz, cat. S	25
KKL PHE	766 997	Empty plastic case f. PHE, 930x215x140mm	189	PHE 3 20 S FU 1P	767 416	PHE voltage detector, switchable, 3..10kV/50Hz a. 6..20kV/50Hz u. 6..20kV/16.7Hz	165
KKL PHE L	766 999	Empty plastic case f. PHE L, 1270x215x140mm	189	PHE 6 S	767 406	PHE voltage detector, 6kV/50Hz, cat. S	25
KKL PHE3	767 997	Empty plastic case f. PHE III, 930x215x140mm	189	PHE 6 20 S	767 420	PHE voltage detector, 6..20kV/50Hz, cat. S	25
KKL PHE3 60 110	766 998	Empty plastic case f. PHE III, 1270x215x140mm	189	PHE 6 20 S 16.7 1P	767 415	PHE voltage detector, 6..20kV/16.7Hz kit f. electric point a. train pre-heating systems	165
KKL PHE3 L	767 999	Empty plastic case f. PHE III L, 1270x215x140mm	189	PHE 10 S	767 418	PHE voltage detector, 10kV/50Hz, cat. S	25
KKL PHV	759 999	Empty plastic case f. PHV, 930x215x140mm	189	PHE 15 16.7 4T TA	766 616	PHE voltage detector kit, 15kV/16.7Hz, w. bag	163
KKL PHV1	759 998	Empty plastic case f. PHV I, 1270x215x140mm	189	PHE 15 16.7 6T TA	766 617	PHE voltage detector kit, 15kV/16.7Hz, w. bag	163
KKL PK PHE3 L	766 036	Empty plastic case f. PK PHE III, 395x295x106mm	189	PHE 15 16.7 BEL STK	767 413	PHE voltage detector, 15kV/16.7Hz	166
KKL SDS KEV MS	785 298	Empty plastic case f. SDS KEV MS	147	PHE 15 30 S	767 430	PHE voltage detector, 15..30kV/50Hz, cat. S	25
KKL TFRS MS	785 951	Empty plastic case f. TFRS MS, 840x400x380mm	139	PHE 20 S	767 428	PHE voltage detector, 20kV/50Hz, cat. S	25
KKL TRS MS	785 301	Empty plastic case f. TRS MS	139	PHE 30 S	767 438	PHE voltage detector, 30kV/50Hz, cat. S	25
KKL TRS NS	785 506	Empty plastic case f. TRS NS	133	PHE A 15 16.7	766 677	Indicator PHE, 15kV/16.7Hz, 930mm	200
KLFP M12 KSS	795 040	Fixed clamping point f. KSS M12, St/gal Zn-Al	84	PHE PK 15 16.7	766 678	Indicator f. PHE, 15kV/16.7Hz, 1900mm	200
KLT 101 30 10	767 996	Empty artificial leather bag, 1010x300x100mm	191	PHE U 3 30 S	767 433	PHE voltage detector, switchable, cat. S 3..10kV a. 6..20kV a. 15..30kV/50Hz	25
KLT 104 9	767 574	Empty artificial leather bag, Ø90x1040mm	191	PHE3 3 10 S	767 711	PHE III voltage detector, 3..10kV/50Hz, cat. S	13
KLT 121 25 16	766 601	Empty artificial leather bag, 1200x250x160mm	191	PHE3 3 10 S ZK	767 941	PHE III voltage detector w. ZK, 3..10kV/50Hz, cat. S	15
KLT 133 34 10	766 996	Empty artificial leather bag, 1330x345x100mm	191	PHE3 3 S	767 703	PHE III voltage detector, 3kV/50Hz, cat. S	13
KLT 140 28	785 952	Empty artificial leather bag, 1400x280mm	139	PHE3 3 S ZK	767 903	PHE III voltage detector w. ZK, 3kV/50Hz, cat. S	15
KLT 160 17	766 614	Empty artificial leather bag, Ø170x1600mm	191	PHE3 6 20 S	767 721	PHE III voltage detector, 6..20kV/50Hz, cat. S	13
KLT 23 16 4	767 500	Empty artificial leather bag, 235x160x40mm	191	PHE3 6 20 S ZK	767 951	PHE III voltage detector w. ZK, 6..20kV/50Hz, cat. S	15
KLT 247 10 22	766 602	Empty artificial leather bag, 2470x100x220mm	191	PHE3 6 20 SL	767 740	PHE III voltage detector, 6..20kV/50Hz, cat. S/L	13
KS SG BLS 8	766 105	Plastic star grip screw	209	PHE3 6 20 SL ZK	767 940	PHE III voltage detector w. ZK, 6..20kV/50Hz, cat. S/L	15
KS60 12SK A	795 143	Short-circuiting bar 60x12mm, AlMgSi 0.5, SK	85	PHE3 6 S	767 706	SPHE III voltage detector, 6kV/50Hz, cat. S	13
KS60 12SK C	795 139	Short-circuiting bar 60x12mm, E-Cu F20, SK	85	PHE3 6 S ZK	767 906	PHE III voltage detector w. ZK, 6kV/50Hz, cat. S	15
KS60 12SQ A	795 149	Short-circuiting bar 60x12mm, AlMgSi 0.5, SQ	85	PHE3 10 30 S	767 731	PHE III voltage detector, 10..30kV/50Hz, cat. S	13
KS60 12SQ C	795 145	Short-circuiting bar 60x12mm, E-Cu F20, SQ	85	PHE3 10 30 S ZK	767 961	PHE III voltage detector w. ZK, 10..30kV/50Hz, cat. S	15
KS60 8SK A	795 142	Short-circuiting bar 60x8mm, AlMgSi 0.5, SK	85	PHE3 10 30 S ZK30	767 964	PHE III voltage detector w. ZK, 10..30kV/50Hz, cat. S	23
KS60 8SK C	795 138	Short-circuiting bar 60x8mm, E-Cu F20, SK	85	PHE3 10 30 SL	767 750	PHE III voltage detector, 10..30kV/50Hz, cat. S/L	13
KS60 8SQ A	795 148	Short-circuiting bar 60x8mm, AlMgSi 0.5, SQ	85	PHE3 10 30 SL ZK	767 950	PHE III voltage detector w. ZK, 10..30kV/50Hz, cat. S/L	15
KS60 8SQ C	795 141	Short-circuiting bar 60x8mm, E-Cu F20, SQ	85	PHE3 10 S	767 710	PHE III voltage detector, 10kV/50Hz, cat. S	13
KV4 25 NSFL ISK95	742 225	Four-pole EaS-circuiting device, -95mm <sup>2</sup>	120	PHE3 10 S ZK	767 910	PHE III voltage detector w. ZK, 10kV/50Hz, cat. S	15
KV4 25 NSFL ISK95 E	742 425	Four-six-pole EaS-circuiting device, -95mm <sup>2</sup>	120	PHE3 20 S	767 720	PHE III voltage detector, 20kV/50Hz, cat. S	13
L71 PS PHE 185	767 766	Test prod f. PHE III, cat. L	197	PHE3 20 S ZK	767 920	PHE III voltage detector w. ZK, 20kV/50Hz, cat. S	15
L72 PS PHE 405	767 772	Test prod f. PHE III, cat. L, 415mm	197	PHE3 25 S 50 1P	767 125	PHE III voltage detector, 25kV/50Hz, cat. S	164
LK 4 40 TS SQL	784 352	Conductor clamp f. Ø4-40mm, SQL	180	PHE3 30 S	767 730	PHE III voltage detector, 30kV/50Hz, cat. S	13
MA DCA HR LRM	767 133	Test adapter f. DEHNcap HR-LRM	46	PHE3 30 S ZK	767 930	PHE III voltage detector w. ZK, 30kV/50Hz, cat. S	15
MA DCA LR LRM	767 136	Test adapter DEHNcap LR-LRM	46	PHE3 30 60 L	767 973	PHE III voltage detector kit, 30..60kV/50Hz, cat. L	21
MA DCA XC LRM	767 135	Measuring impedance DEHNcap XC-LRM	46	PHE3 30 60 S	767 971	PHE III voltage detector kit, 30..60kV/50Hz, cat. S	21
MZ 1.5V IEC LR6 AL	766 613	Battery Mignon 1.5V IEC LR6 Alkaline	209	PHE3 60 110 L	767 991	PHE III voltage detector kit, 60..110kV/50Hz, cat. L	22
MZ 1.5V L91 FR6 Li 4	766 611	Battery Mignon 1.5V L91 FR6 Lithium (4 pieces)	205	PHE3 60 110 S	767 990	PHE III voltage detector kit, 60..110kV/50Hz, cat. S	21
NFG MS	785 260	MS refilling device	145	PHE3 60 110 S IT	767 962	PHE III voltage detector kit, 60..110kV/50Hz, cat. S	23
NHS AG 00 3 NS	785 645	Fuse puller w. sleeve NH00-3, -1000V	154	PHE3 60 132 SL	767 992	PHE III voltage detector kit, 60..132kV/50Hz, cat. S/L	22
OEB NFG MS	785 264	Reservoir f. NFG MS	145	PHE3 60 132 SL ZK	767 993	PHE III volt. detector w. ZK, 60..132kV/50Hz, cat. S/L	23
OEK 12 NS	785 649	Eye Ø12 mm, f. covering material -1000V	159	PHE3 110 132 S	767 130	PHE III volt. detector, 110..132kV/50Hz, 16.7Hz, cat. S	167
PAP 2 M12 SSM B13	728 312	Two-pole phase connecting plate, w. 2 screw connections M12 w. nuts	92	PHE3 A 10 30 S	767 965	PHE III ZK indicator, 10..30kV, cat. S	200
PFP 11 33 AL 60 82	731 011	PFP f. conductor Ø11-33mm, Al, width 82x60mm	83	PHE3 A 20 SL	767 722	PHE III ZK indicator, 20kV, cat. S/L	200
PFP 11 33 CU 60 82	731 027	PFP f. conductor Ø11-33mm, Cu, width 82x60mm	83	PHE3 A 60 110 L	767 726	PHE III indicator, 60..110kV/50Hz, cat. L	200
PFP 34 48 AL 60 98	731 013	PFP f. conductor Ø33-48mm, Al, width 98x60mm	83	PHE3 A 60 110 S	767 734	PHE III indicator, 60..110kV/50Hz, cat. S	200
PFP 34 48 CU 60 98	731 037	PFP f. conductor Ø33-48mm, Cu, width 98x60mm	83	PHE3 A 60 110 S IT	767 963	PHE III indicator, 60..110kV, cat. S	200
				PHE3 A 60 132 SL	767 732	PHE III indicator, 60..132kV/50Hz, cat. S/L	200
				PHE3 A 60 132 SL ZK	767 735	PHE III ZK indicator, 60..132kV/50Hz, cat. S/L	200
				PHE3 A 110 132 S	767 129	PHE III indicator, 110..132kV, cat. S	200
				PHE3 PK6 20 L SB ZK	767 922	PHE III ZK indicator, 6..20kV/50Hz, cat. L, w. standby function	17

Type	Part No.	Product	Page	Type	Part No.	Product	Page
PHE3 PK6 20 S SB ZK	767 921	PHE III ZK indicator, 6..20kV/50Hz, cat. S, w. standby function	17	PSK 10 65 SQL EH	784 501	Phase screw clamp w. coupling aid, Ø10-65mm, SQ, PK1	93
PHE3 PK10 30 L SB ZK	767 932	PHE III ZK indicator, 10..30kV/50Hz, cat. L, w. standby function	17	PSK 10 85 SQL	784 085	Phase screw clamp, Ø10-85mm, SQ, PK2	93
PHE3 PK10 30 S SB ZK	767 931	PHE III ZK indicator, 10..30kV/50Hz, cat. S, w. standby function	17	PSK 4 30 SQL	784 201	Phase screw clamp, Ø4-30mm, SQ, PK1	93
PHE3 U 3 30 S	767 733	PHE III voltage detector, switchable, cat. S, 3..10kV a. 10..30kV/50Hz	13	PSK 4 30 SQL EH	784 401	Phase screw clamp w. coupling aid, Ø4-30mm, SQ, PK1	93
PHE3 U 3 30 S ZK	767 960	PHE III voltage detector w. ZK, switchable, cat. S, 3..10kV a. 10..30kV/50Hz	15	PSK FV 4 30 SQL	784 480	Spring-loaded phase screw clamp, Ø4-30mm, SQ, PK1	93
PHE3S 10 110 S	767 984	PHE III voltage detector kit, 10..20kV/50Hz, cat. S	23	PSO M8 PHE	766 916	Test probe f. PHE, 3..24kV/50Hz, w. M8	198
PHE3S 20 L ZK	767 725	PHE III voltage detector kit, 20kV/50Hz, cat. L	19	PSO M8 PHE L800	766 960	Test probe f. PHE, 3..24kV/50Hz, Ø14mm, 800mm, w. M8	198
PHE3S 20 S ZK	767 724	PHE III voltage detector kit, 20kV/50Hz, cat. S	19	PSO M8 W25 PHE	766 940	Test probe f. PHE, 25° angled, 3..24kV/50Hz, w. M8	199
PHE3S 30 60 L	767 975	PHE III voltage detector kit, 30..60kV/50Hz, cat. L	21	PSO M8 W45 PHE	766 941	Test probe f. PHE, 45° angled, 3..24kV/50Hz, w. M8	199
PHE3S 30 60 S	767 970	PHE III voltage detector kit, 30..60kV/50Hz, cat. S	21	PSO M8 W90 PHE	766 950	Test probe f. PHE, angled, 3..24kV/50Hz, Ø14mm, 800mm, w. M8	199
PHE3S 110 132 S	767 131	PHE III voltage detector kit, 110..132kV/50Hz, cat. S	167	PSS DII	745 109	Installation adapter DII	121
PHE3S2 60 110 L	767 981	PHE III voltage detector kit, 60..110kV/50Hz, cat. L	22	PV DCA PC LRM	767 132	DEHNcap PC-LRM phase comparator	44
PHE3S2 60 110 S	767 980	PHE III voltage detector kit, 60..110kV/50Hz, cat. S	21	PV DCA PC LRM T	767 139	DEHNcap PC-LRM phase comparator w. bag	44
PHE3S2 60 132 SL	767 982	PHE III voltage detector kit, 60..132kV/50Hz, cat. S/L	22	QD 35 W NS	785 543	Cross cleaning head, angled f. TRS NS, Ø25, 35 mm	134
PHE3S2 60 132 SL ZK	767 983	PHE III volt. detector kit w. ZK, 60..132kV/50Hz, cat. S/L	23	RB 20 NS	785 585	Cleaning brush f. kit parts, Ø20mm	142
PHEG1.FD M SN7...	767 655	PHE/G I d.c. volt. detector, negative pole, -24kV	31/171	RB 40 NS	785 580	Cleaning brush f. kit parts, Ø40mm	134
PHEG1.FD P SN7...	767 650	PHE/G I d.c. volt. detector, positive pole, -24kV	31/171	RB 50 MS	785 210	Cleaning brush f. kit parts, Ø50mm, 1430mm	142
PHEG1.S M SN7...	767 665	PHE/G I d.c. voltage detector, w. negative pole w. test prod, -24kV	31/171	RD 25 P NS	785 570	Round cleaning head w. brush, Ø25mm	134
PHEG1.S P SN7...	767 660	PHE/G I d.c. voltage detector, w. positive pole w. test prod, -24kV	31/171	RD 25 S NS	785 560	Round cleaning head w. scraper, Ø25mm, 50mm	133
PHEG2 P SN7...	767 602	PHE/G II d.c. voltage detector, two sticks w. positive pole w. test prod	32/172	REB 1095 MS	785 160	Rectangular brush, 105x90x50mm	140
PHEG2.P SN7...	767 670	PHE/G II d.c. voltage detector, two sticks w. positive pole w. test prod, -24kV	32/172	RED E27 E14 ÜGK MB	745 108	Adapter E27-E14	121
PHG2 6	766 706	PHG II voltage detector, 6kV/50Hz, cat. S, w. LED	29	RFB NFG MS	785 295	Reservoir f. NFG MS	145
PHG2 10	766 710	PHG II voltage detector, 10kV/50Hz, cat. S, w. LED	29	RK 230 100 AS25	766 056	Cleaning head f. attaching cleaning pads, 230mm, 100mm, -Ø25mm	201
PHG2 20	766 720	PHG II voltage detector, 20kV/50Hz, cat. S, w. LED	29	RP 15 ZK MS	785 321	Round brush f. FRS MS w. ZK, Ø15mm, -36kV	140
PHSP NS	785 497	Pneumatic glove tester, -1000V	155	RP 250 115 20	766 057	Cleaning pad, 250x115x20mm, 1 set = 5 pieces	201
PHV 3 36 STK	759 300	PHV test unit, 3..36kV/50Hz, STK	34	RS 15104 Z MS	785 279	Rectangular cleaning sponge f. FRS MS, 150x100x40mm, serrated, -36kV	141
PHV1 6 12	759 606	Single-pole phase comparator, 6..12kV/50Hz	36	RS 1544 MS	785 274	Rectangular cleaning sponge f. FRS MS, 150x40x40mm, -36kV	141
PHV1 12 24	759 612	Single-pole phase comparator, 12..24kV/50Hz	36	RS 1574 MS	785 275	Rectangular cleaning sponge f. FRS MS, 150x70x40mm, -36kV	141
PHV1 24 36	759 624	Single-pole phase comparator, 24..36kV/50Hz	36	RSD 15104 Z MS	785 280	Rectangular cleaning sponge f. FRS MS, 150x100x40mm, serrated, -36kV	141
PHV1 U 6 36	759 616	Single-pole phase comparator, switchable 6..12kV/50Hz a. 12..24kV/50Hz a. 24..36kV/50Hz	36	RSI 32	785 213	Reducing insert NS/MS, Ø32mm	143
PK FV 4 25	784 490	Spring-loaded clamp f. overhead lines Ø4-25mm	95	RSI 34	785 214	Reducing insert NS/MS, Ø34mm	143
PS 10 12 PHV	759 610	Test prod f. PHV, 10..12kV/50 Hz, electrode w. M8	35	RSI 35	785 215	Reducing insert NS/MS, Ø35mm	143
PS 10 12 PHV D11	759 111	Test prod f. PHV, 10..12kV/50 Hz, Ø11mm, 415mm	35	RSI 38	785 216	Reducing insert NS/MS, Ø38mm	143
PS 10 12 PHV W90	759 611	Test prod f. PHV, 10..12kV/50 Hz, 90°, electr. w. M8	35	RSI 45	785 217	Reducing insert NS/MS, Ø45mm	143
PS 10 17.5 PHV	759 615	Test prod f. PHV, 10..17.5kV/50 Hz, electrode w. M8	35	RSI 51	785 218	Reducing insert NS/MS, Ø51mm	143
PS 15 24 PHV	759 620	Test prod f. PHV, 15..24kV/50 Hz, electrode w. M8	35	RSI 58	785 219	Reducing insert NS/MS, Ø58mm	143
PS 15 24 PHV L880	759 621	Test prod f. PHV, 15..24kV/50 Hz, 880mm, electr. w. M8	35	RST 36 1000	766 040	Rescue rod, 1000mm, 36kV	60
PS 15 24 PHV W90	759 622	Test prod f. PHV, 15..24kV/50 Hz, 90°, electr. w. M8	35	RST 36 1500	766 041	Rescue rod, 1500mm, 36kV	60
PS 20 24 PHV D11	759 121	Test prod f. PHV, 20..24kV/50 Hz, Ø11mm, 585mm	35	RST 36 2000	766 042	Rescue rod, 2000mm, 36kV	60
PS 25 36 PHV	759 630	Test prod f. PHV, 25..36kV/50 Hz, electrode w. M8	35	S 30 ZK MS	785 320	Scraper w. ZK f. FRS MS, 30mm, -36kV	140
PS 25 36 PHV W90	759 633	Test prod f. PHV, 25..36kV/50 Hz, 90°, electr. w. M8	35	S60 PS PHE 285	767 760	Test prod S60 f. PHE III, 320mm, cat. S/L	197
PS 3 3.6 PHV	759 603	Test prod f. PHV, 3..3.6kV/50 Hz, electrode w. M8	35	S61 PS PHE 435	767 761	Test prod S61 f. PHE III, 435mm	197
PS 3 3.6 PHV W90	759 604	Test prod f. PHV, 3..3.6kV/50 Hz, 90°, electr. w. M8	35	S62 PS PHE 620	767 762	Test prod S 62 f. PHE III, 655mm	197
PS 5 7.2 PHV	759 605	Test prod f. PHV, 5..7.2kV/50 Hz, electrode w. M8	35	S63 PS PHE 780	767 763	Test prod S63 f. PHE III, 815mm	197
PS 5 7.2 PHV W90	759 608	Test prod f. PHV, 5..7.2kV/50 Hz, 90°, electr. w. M8	35	S63 PS PHE 8CK	767 768	Test prod f. PHE III, cat. S f. 8CK switchgear installation	197
PS DCA HR LRM	767 150	DEHNcap HR-LRM test set w. plastic case	45	S64 PS PHE 880	767 764	Test prod S64 f. PHE III, 915mm	197
PS PHE 15 16.7	766 619	Test prod f. PHE, 15kV/16.7Hz, 1060mm	197	S65 M PS PHE 905	767 767	Test prod f. PHE III, cat. S f. Mipak switchgear installation	197
PSK 10 32 SQL	784 032	Phase screw clamp, Ø10-32mm, SQ, PK2	93	S66 PS PHE 880	767 771	Test prod S66 f. PHE III, 915mm	197
PSK 10 32 SQL SB	784 038	Phase screw clamp w. safety bow Ø10-32mm, SQ	93	SA KLFP SK	795 214	SK screw-type adapter	85
PSK 10 65 SQL	784 301	Phase screw clamp, Ø10-65mm, SQ, PK1	93				

## Type / Product Index

Type	Part No.	Product	Page	Type	Part No.	Product	Page
SA KLFP SQ	795 213	SQ screw-type adapter	85	SRH 1180 IS 650 MS	785 119	Intake tube with handle, Ø40mm, 1180mm, insulating element 650mm	143
SAG DCA A HR	767 111	DEHNcap A-HR voltage indicator	42	SRH 1180 MS	785 120	Intake tube with handle Ø40mm, 1180mm, -36kV	139
SAG DCA A LRM	767 112	DEHNcap A-LRM voltage indicator	42	SRH 400 NS	785 520	Intake tube with handle Ø40mm, 380mm, -1000V	133
SAG DCA P HR	767 101	DEHNcap P-HR voltage indicator	40	SRV 200 MS	785 121	Extension Ø40mm, 200mm, -36kV	139
SAG DCA P LRM	767 102	DEHNcap P-LRM voltage indicator	40	SRV 200 NS	785 521	Extension Ø40mm, 200mm, -1000V	133
SAK PFE KN	792 450	Clamp for railway tracks w. tommy bar	181	SRV 300 NS	785 522	Extension Ø40mm, 300mm, -1000V	133
SAK PFE RA	792 453	Clamp for railway tracks w. ratchet	181	SRV 400 MS	785 122	Extension Ø40mm, 400mm, -36kV	139
SBKL EKS TI KVS	766 300	Empty sheet metal case f. EaS kit TI, f. KVS	188	SRV 400 NS	785 523	Extension Ø40mm, 400mm, -1000V	133
SBKL EKS TI KVS 2F	766 298	Empty sheet metal case f. EaS kit TI, f. KVS 2fach	188	SRV 800 MS	785 123	Extension Ø40mm, 800mm, -36kV	139
SBKL EKS VI KVS	745 900	Empty sheet metal case f. EaS kitVI, f. KVS	188	SRW 90 MS	785 131	90° angled intake tube, Ø40mm, 120mm, -36kV	139
SCH A13 V2A	525 912	Washer DIN 125, A13, StSt	208	SRW 135 MS	785 132	135° angled intake tube, Ø40mm, 100mm, -36kV	139
SCH A17 V2A	525 916	Washer DIN 125, A17, StSt	208	SRW V MS	785 130	Angled intake tube, adjustable, Ø40mm, -36kV	139
SCS 36 1000	763 610	Switching stick, 1000mm, 36kV	57	SRW V NS	785 530	Angled intake tube, adjustable Ø40mm, -1000V	133
SCS 36 1500	763 611	Switching stick, 1500mm, 36kV	57	SSA W D	785 200	Intake hose adapter, angled, Ø40mm	141
SCS 36 2000	763 612	Switching stick, 2000mm, 36kV	57	SSC ASH NS	785 427	Face shield w. strap, size 52-63, -1000V	154
SCS 36 STK 1000	763 100	Switching stick w. STK, 1000mm, 36kV	57	SSK 36 STK 560	766 164	Switching stick head w. STK, -36kV/50Hz, L 560mm	201
SCS 72 1500	763 615	Switching stick, 1500mm, 72kV	57	SSK M12	765 005	Switching stick head w. M12 thread	52
SCS 72 2000	763 620	Switching stick, 2000mm, 72kV	57	SSK SQ	765 009	Switching stick head w. SQ	52
SCS 72 STK 1500	763 150	Switching stick w. STK, 1500mm, 72kV	57	STB 80 MS	785 171	Tubular brush, Ø80mm, 240mm, -36kV	140
SCS 123 STK 2000	763 180	Switching stick w. STK, 2000mm, 123kV	57	STB 120 MS	785 170	Tubular brush, Ø120mm, 250mm, -36kV	140
SCSN 36 1000	763 510	Switching stick, 1000mm, 36kV	56	STB 80 K MS	785 172	Tubular brush, conical bristles, Ø80mm, -36kV	140
SCSN 36 1500	763 511	Switching stick, 1500mm, 36kV	56	STB 85 K NS	785 555	Tubular brush, conical bristles, Ø25/85mm, -1000V	134
SCSN 36 2000	763 512	Switching stick, 2000mm, 36kV	56	STB 85 Z NS	785 550	Tubular brush, cylindrical bristles, Ø25/85mm, -1000V	134
SCSN 36 STK 1000	763 111	Switching stick, 1000mm, 36kV	56	STT 55 27 30	785 111	Canvas bag, empty, 550x240x300mm	192
SCSN 123 STK 2800	763 181	Switching stick, 2800mm, 123kV	56	STT 110 15	769 509	Canvas bag, empty, Ø150mm, 1100mm	192
SCSS 36 STK 30	766 323	Switching stick kit w. STK, Ø30mm, 36kV	51	STT 120 30 15	766 704	Canvas bag with carrier handle, 1200x300x150mm	192
SCSSN 36 STK 30	766 324	Switching stick kit w. STK, Ø30mm, 36kV	49	STT 180 20	766 039	Canvas bag, empty, Ø200mm, 1800mm	192
SDS 1	923 110	Spark gap unit f. power frequency sparkover voltage 940V	186	SZ HH 1060	765 040	Straight fuse tong, Ø30..90mm, 1060mm, -36kV	59
SDS 2	923 117	Spark gap unit f. d.c. sparkover voltage 350V	186	SZ HH 1250	765 041	Straight fuse tong, Ø30..90mm, 1250mm, -36kV	59
SDS 3	923 116	Spark gap unit f. d.c. sparkover voltage 550V	186	SZ HH 1500	765 042	Straight fuse tong, Ø30..90mm, 1500mm, -36kV	59
SDS 4	923 118	Spark gap unit f. d.c. sparkover voltage 230V	186	SZ HH W20 1070	765 050	Angled fuse tong, Ø30..90mm, 1070mm, -36kV	59
SDS 5	923 119	Spark gap unit f. d.c. sparkover voltage 120V	186	SZ HH W20 1250	765 051	Angled fuse tong, Ø30..90mm, 1250mm, -36kV	59
SDS KEV MS	785 265	MS screw driver set of cable sealing ends	147	SZ HH W20 1500	765 052	Angled fuse tong, Ø30..90mm, 1500mm, -36kV	59
SE E14	785 639	Insulating plug f. screw insert E14	160				
SE E18	785 650	Insulating plug f. screw insert E18	160	TFRS MS	785 950	Combined cleaning kit MS, -36kV	138
SE E27 E33	785 640	Insulating plug f. screw insert E27/E33	160	TG DCA	767 110	DEHNcap P-HR/LRM test unit	41
SE NHO	785 642	Insulating blade f. NH fuse holder, size 0	160	TRS MS	785 100	Dry cleaning kit MS, -36kV	136
SE NH00	785 641	Insulating blade f. NH fuse holder, size 00	160	TRS MS V1	785 112	Dry cleaning kit MS, -36kV	136
SE NH1	785 643	Insulating blade f. NH fuse holder, size 1	160	TRS NS	785 502	Dry cleaning kit NS, -1000V	133
SE NH2 3	785 644	Insulating blade f. NH fuse holder, size 2-3	160				
SE REG 1TE	785 638	Lock-out system f. circuit breakers, size 45mm, 1TE	160	UEK 25 FS	774 034	Universal clamp w. wing bolt, Ø20/25mm, T 15mm, Rd/Fl 20mm	98
SE REG 2TE	785 652	Lock-out system f. circuit breakers, size 45mm, 2TE	160	UEK 25 HG	774 234	Universal clamp w. plastic handle, Ø20/25mm, T 15mm, Rd/Fl 20mm	98
SE REG 3TE	785 637	Lock-out system f. circuit breakers, size 45mm, 3TE	160	UEK 25 SKN	774 434	Universal clamp w. tommy bar, Ø20/25mm, T 15mm, Rd/Fl 20mm	98
SF FRF MS	785 953	Spray bottle f. cleaning liquids	142	UEK 30 FS	774 130	Universal clamp w. wing bolt, Ø25/30mm, T 18mm, Rd/Fl 30mm	98
SKL 95 21 10	767 701	Empty sheet metal case f. PHE III, 950x210x100mm	188	UEK 30 HG	774 330	Universal clamp w. plastic handle, Ø25/30mm, T 18mm, Rd/Fl 30mm	98
SKL 95 21 10 V2	759 003	Empty sheet metal case f. PHV, 950x210x100mm	188	UEK 30 SKN	774 530	Universal clamp w. tommy bar, Ø30mm, T 18mm, Rd/Fl 30mm	98
SKL 116 16 10	766 603	Empty sheet metal case f. PHE, 1160x160x100mm	188	UK 25 SK	773 034	Universal clamp SK, Ø20/25mm, T 15mm, Rd/Fl 20mm	91
SKS M12 25 V2A	561 925	Hexagon bolt DIN 933, M12x25mm, StSt	208	UK 25 SQ	773 234	Universal clamp SQ, Ø20/25mm, T 15mm, Rd/Fl 20mm	91
SKS M12 30 V2A	561 930	Hexagon bolt DIN 933, M12x30mm, StSt	208	UK 25 SQL	773 236	Univ. clamp SQL, Ø20/25mm, T 15mm, Rd/Fl 20mm	96
SKS M12 35 V2A	561 935	Hexagon bolt DIN 933, M12x35mm, StSt	208	UK 30 SK	773 130	Universal clamp SK, Ø25/30mm, T 18mm, Rd/Fl 30mm	91
SKS M16 30 V2A	561 931	Hexagon bolt DIN 933, M16x30mm, StSt	208	UK 30 SQ	773 330	Universal clamp SQ, Ø25/30mm, T 18mm, Rd/Fl 30mm	91
SLK 92 16 10	766 703	PHG II voltage detector, 6kV/50Hz, cat. 5, w. LED	188	UK 30 SQL	773 331	Univ. clamp SQL, Ø25/30mm, T 18mm, Rd/Fl 30mm	96
SPG DCA IT HR	767 121	DEHNcap IT-HR interface test unit	43				
SPG DCA IT LRM	767 122	DEHNcap IT-LRM interface test unit	43				
SPN 500	766 541	Two-pole SPN voltage detector, 100-500V AC/DC	123				
SPN 1000	766 545	Two-pole SPN voltage detector, 120-1000V AC/DC	123				
SRA MS	785 212	Intake tube adapter f. TRS MS, Ø20/40mm, -36kV	141				
SRA NS	785 515	Intake tube adapter f. TRS NS, Ø40/25 mm, -1000V	134				



Type	Part No.	Product	Page
UK K25 FL30 HG	774 251	Universal clamp w. plastic handle, FI/Rd -30mm a. fixed ball point Ø25mm	181
UK K25 FL30 SQL	773 251	Universal clamp SQL, f. FI/Rd -30mm and fixed ball point Ø25mm	181
VL 350 SD KEV MS	785 273	Extension for operating stick KEV MS, 350mm	147
VS 500 SPN II	766 542	Extension prod f. SPN voltage detector, 500mm	123
VS F&G M22 F	785 281	Screw plug F&G for cable sealing end	148
VS GOW M12	785 284	Screw plug GOW for cable sealing end	148
VS KOET M10	785 282	Screw plug KÖTTGEN for cable sealing end	148

Type	Part No.	Product	Page
VS RAY M14	785 283	Screw plug RAYCHEM for cable sealing end	148
WBN 200 2,5M NS	785 646	Insulated covering material, 200x2500mm, -1000V, Chloroprene rubber	159
ZA 25 ISK95 300	740 300	Additional single-pole conductor, 25mm <sup>2</sup> , insulating tube length 300mm	120
ZA 25 ISK95 800	740 800	Additional single-pole conductor, 25mm <sup>2</sup> , insulating tube length 800mm	120

## Notes

### Trademarks

- ...MIT SICHERHEIT DEHN.
- Colour trademark "red" 302 40 296.9

and our brand



are registered trademarks of  
DEHN + SÖHNE GmbH + Co.KG.  
in Germany

### Abbreviations

<b>Instr. No.</b>	Instructions for use No.
<b>VPE</b>	Packing unit
<b>VE</b>	Quantity per unit (piece, metre, set or pair)
<b>Stk.</b>	Piece
<b>m</b>	Metre
<b>Sa</b>	Set
<b>Pa</b>	Pair
<b>STK</b>	Plug-in coupling
<b>ZK</b>	Universal gear coupling
<b>SK</b>	Hexagon shaft
<b>SQ</b>	T pin shaft
<b>SQL</b>	Long T pin shaft
<b>PFP</b>	Fixed phase point
<b>FS</b>	Wing bolt
<b>HG</b>	Plastic handle
<b>NS</b>	Low-voltage -1000 V
<b>MS</b>	Medium-voltage -36 kV
<b>TI</b>	Partly insulated
<b>VI</b>	Fully insulated

Since we do not plan systems or parts of systems, our product recommendations should be regarded as product information and for advisory purposes only. Our oral and written application proposals are based on experience and are specified to the best of our knowledge. We do not accept any liability in this respect. This particularly applies to the different conditions of use which are beyond our control. We recommend to check whether the respective DEHN product is suitable for the intended application. Application, use and processing of our products are beyond our control. Therefore, the product is completely subject to the user's responsibility.

## Conversion List Eas Devices

Part No.	Variant No.	Part No.	Variant No.	Part No.	Variant No.	Part No.	Variant No.	Part No.	Variant No.	Part No.	Variant No.
711 025	VSUSPSQ	712 065	V12QSRJ	712 843	VLS4RHM	725 046	VYYTU8S	725 392	V3XVRYH	735 132	VNZA8BG
711 031	V1YZ3L6	712 068	VUYUF4G	712 845	VW4MHGQ	725 048	VGGR6AW	725 393	V2M12P7	735 134	VRKFLGP
711 044	VE1T6A9	712 069	VVK91T1	712 846	V1VZCMP	725 049	V259F6X	725 604	VNC1S9W	735 135	VEVC88L
711 045	VTUMV5L	712 073	V91P6T4	712 861	VQC6L7X	725 050	VQRMRS1	725 618	VRDSN66	735 136	V9746CX
711 046	VLXJNYB	712 075	V2DLHU8	712 862	VCYVWPY	725 052	V4DGG87	725 619	V8646PA	735 138	VZVE8AN
711 049	VQBFMVS	712 076	V3RCCC7	712 863	VAB1FV6	725 053	VJ5AQED	725 620	VMFPPH3	735 139	VKDSSSD
711 050	VCDAK6Q	712 107	VKYYNKC	712 865	VACNLP8	725 060	VKFQ7Y5	725 621	VJAJCEL	735 317	V8ZNSNV
711 053	VMD2JMZ	712 123	VASXABX	712 866	V4PH61X	725 061	VBQ44HR	725 718	VEE97GA	735 325	VLLJ6QP
711 060	V4RD636	712 125	V2LWDK3	712 950	V4C1TCQ	725 063	V5RVBJM	725 719	VPUQEZY	735 331	V5SEW7H
711 061	VRSSSBX	712 127	VMRG45C	712 951	V478EF9	725 064	VAS1WX7	725 720	V9YPM5V	735 357	VH2E9XU
711 064	VVAH34F	712 135	VN2Y5Q1	715 025	VR688CW	725 065	VBV1K2D	725 721	V9JY75X	735 358	V2WL665
711 065	VS8MB8B	712 139	V7JPAT3	715 031	VMV6X85	725 067	V8P397H	725 802	V55FLXX	735 359	V7MCB5S
711 068	VQUYPTY	712 171	VBBCS9Z	715 044	VVYAW28	725 068	VCE3GHL	725 804	V1DNFBC	735 360	VCK9VSV
711 069	VUBAZLG	712 172	VHDXTPA	715 046	VMBNDQB	725 069	VL5CXAT	725 806	VYSPPEE	735 362	VW96P5V
711 317	V4GN94T	712 173	V5CC446	715 050	VR9DVNF	725 101	VW17KTH	725 807	VGD1EZ8	735 363	VBDY922
711 325	VRL934N	712 317	V4NK7ZF	715 053	VUS5RRZ	725 103	V6C3Q27	725 811	VDTTDE3	735 365	VF8ZG5K
711 331	V2AYNJJ	712 325	VMTB5F7	715 061	VVCABVX	725 104	V36B5C5	725 813	VN6GT4A	735 367	VSK5E2J
711 350	VTSY9XH	712 331	VMXV1VK	715 065	VQA4VCD	725 105	V244QB6	725 815	V4QD9ZG	735 368	V8DXNGZ
711 351	V8ZQEUM	712 350	VCBACWY	715 068	VBP8YK7	725 106	V4ETA8H	725 816	VB1SAB5	735 369	VPH1D4A
711 353	VW1EHC	712 351	VL1XVBH	715 069	V9B84MW	725 107	VQ1Y3QZ	725 821	VR5N9BK	735 370	V7AMLLQ
711 354	VLMAF1L	712 356	VGGH5XH	715 317	VCRPFWY	725 108	VG6MJX	725 822	VN88MAC	735 372	VCPN2WV
711 356	VDNQB1T	712 357	VG7AWAD	715 325	V3NRUS8	725 110	VCP2UFG	725 823	V7XNCZ5	735 373	VSNXHDG
711 357	V59G6XV	712 358	V7N6439	715 331	V8N2TVX	725 112	VMVTYXH	725 825	V8UW776	735 375	VHW33QC
711 358	VFJSUAG	712 359	VJ3LCX6	715 350	VHBWUNH	725 113	V96JHL	725 826	VMYTHEM	735 377	VTLW8ST
711 359	VYF4YEJ	712 360	V2YYL7V	715 351	VZBSKYB	725 114	V3ZGMRV	725 831	VXT7RNE	735 378	VGLLCDR
711 360	VSUTC9Y	712 362	V4X4YU8	715 356	VK3BMXP	725 115	V2ZHTWC	725 832	VHBCFBH	735 379	V33KFTR
711 362	VRPSCXL	712 363	VY7DWFA	715 357	VNDPX7S	725 117	VTU3FXF	725 833	V1FQE9S	735 380	V4UH7EZ
711 363	VLBKQD3	712 365	VVUGU5T	715 358	VUPZSM5	725 123	V8XDNDP	725 835	V8VF7CP	735 382	VVM4KGN
711 365	VE2HXN5	712 366	V4PSS1S	715 359	V2ZFW21	725 125	VW6P4JC	725 836	VF693LG	735 383	V8953S5
711 366	VEWYT6G	712 367	V293GEU	715 360	VTQV8NF	725 127	VMV4LB1	735 025	VZGQ3SR	735 385	VMQTE8X
711 367	VYHEXQP	712 368	VKHAE3J	715 362	VULRXQG	725 132	VGXLR3B	735 031	VMQ1162	735 387	V4G22DQ
711 368	VJR1UKK	712 369	V2XJV7G	715 363	VF3TX75	725 134	VK9G9UB	735 044	VQYQNGQ	735 388	VERRBY4
711 369	VYKR63U	712 370	V6QT4NC	715 365	VMQWD87	725 135	V5R5FB9	735 045	VFVAHX2	735 389	VZH3WCJ
711 370	VA5E7H5	712 372	VUMTLQG	715 366	VXBV1MP	725 136	VLDDJ97	735 046	VBQC9NR	735 390	VTGCMNB
711 372	V772G2C	712 373	VXW23MB	715 367	VW6NFTQ	725 138	VKSELRQ	735 048	VJT1C7V	735 392	VTUSXJU
711 373	VB8B34N	712 374	V3K847Z	715 368	VSUYZYU	725 139	V2KPDND	735 049	VT854M9	735 393	VQRP4YY
711 375	VDT6K3C	712 375	VA6VR6Q	715 369	V33M4JL	725 317	VRBDGH9	735 050	VY16XXP	735 604	V18JQHQ
711 376	V7HCU52	712 376	V3B3UQ3	715 370	VKNK9YT	725 325	VMPK9SQ	735 052	VWDT71S	735 618	V3WJMY
711 377	VFN4WTN	712 378	VLTR2ND	715 372	VNF9DR7	725 331	V2L1YJ8	735 053	V3QXGLK	735 619	V9TQZU5
711 378	VLJ68A8	712 379	V4NR48U	715 373	VMWJP4E	725 357	VZGWFX	735 060	V3C9LLG	735 620	V8W71S4
711 379	V7TM9N6	712 380	VYQA88X	715 374	VEPBUSF	725 358	VTNZLZY	735 061	VZDZVAJ	735 621	VYH2741
711 380	V99MXGX	712 382	VGJBD1T	715 375	VQQA8ZU	725 359	VTKP6TK	735 063	VQ4VG9W	735 718	V1FCC8E
711 382	VEZNVYJ	712 383	V3QVW33	715 376	VLDPDJ6	725 360	VUFZN7T	735 064	VP9S1Q1	735 719	VDZU7C9
711 383	VKU92MH	712 384	VT8XHFS	715 378	VBZ6V3S	725 362	VNR87MS	735 065	V4F8WMT	735 720	V9YWUP6
711 385	VS82RW5	712 385	VL69TVV	715 379	V7JVGLS	725 363	VKCX2XN	735 067	VZFGW3P	735 721	VQ8K8JL
711 386	VG3KSH4	712 386	VFH38PN	715 380	VFSJ6GG	725 365	VEMU17J	735 068	VJTFDXD	735 802	VRM3DGE
711 387	V34WUBA	712 388	VCC99R6	715 382	V2EVTLW	725 367	VGWSU8G	735 069	VMGSB6N	735 804	VW3CNVB
711 388	VGDJ7SK	712 389	V17HKPC	715 383	VPQA57N	725 368	V15XR1Q	735 101	VHX2314	735 806	VJPBRG7
711 389	VENX63L	712 390	VPHGEBG	715 384	VZTD96U	725 369	VG4M8S	735 103	VVG5MGG	735 807	VPQD4CQ
711 390	VEEGERZ	712 392	VLUK37V	715 385	VL55ZFN	725 370	VE3BZVR	735 104	VCQ5VHL	735 811	VJEKSK4
711 392	VR68JEM	712 393	VGQ1BVV	715 386	V58S8N5	725 372	VTB9WVC	735 105	VWC4LQ6	735 813	VENMVY5
711 393	VDETPMN	712 604	V8115WA	715 388	VJKMTEY	725 373	VD5KG9W	735 106	V4FAD1T	735 815	VAAXPTN
712 025	VE8WZ1W	712 802	V1CV654	715 389	VQQRNWP	725 375	VKZ57BL	735 107	V8CX35Z	735 816	V7Y6Q8Y
712 031	V5NME1N	712 803	VPZQYFF	715 390	V94C53H	725 377	VSYPPGG	735 108	VT3HCAP	735 821	VNRCV5Y
712 044	VZCU1TY	712 804	V31P599	715 392	V86TZPA	725 378	VKKS85U	735 110	VDCXLB3	735 822	V3J1QF8
712 045	VN7Z2RZ	712 806	VBAGHUX	715 393	VWXM7XF	725 379	VA8HJYU	735 112	VCJXH1D	735 823	VFXCRJ
712 046	VMUCEH5	712 807	V6TDQYM	715 604	V11E77B	725 380	V3TU5KE	735 113	VC1ERK1	735 825	V556HLB
712 049	VJ8VRQJ	712 811	VAPQBIZ	715 950	VAUTRKE	725 382	V768UCY	735 114	VKWUX5M	735 826	VV1G5YV
712 050	VWRZFKX	712 812	V8AUKEKX	715 951	VPZ3MLG	725 383	VWH5K29	735 115	VD771BW	735 831	VK94NLM
712 053	VZTKJ9K	712 813	VBQXB34	725 025	VGK338W	725 385	VHR6GRD	735 117	V9KFP4D	735 832	VXDSR1B
712 060	VZF9JKJ	712 815	V22299H	725 031	VSV8EYY	725 387	VXT2ZC8	735 123	V73U6T8	735 833	VJH5VX8
712 061	VYTJJ23	712 816	V62TQA8	725 044	VZBV32Q	725 388	V6XJJ2K	735 125	V6ZU77Q	735 835	V5VN56Z
712 064	VVVSDBQ	712 841	VZJMNE	725 045	VXUVL6J	725 389	VS9CTQF	735 127	VW3AA59	735 836	VK6HC5U
		712 842	V9UDX2F			725 390	VEKR57C				

## Conversion List EaS Devices

Part No.	Variant No.	Part No.	Variant No.	Part No.	Variant No.	Part No.	Variant No.	Part No.	Variant No.	Part No.	Variant No.
743 225	VH8QTCZ	750 353	VZKJEJD	770 050	VKB9CSW	770 392	VQPB743	794 357	V8F74EG	795 317	VA3G5RT
743 235	VKB2Q6J	750 354	VQSQ6PK	770 053	V7F1ZUL	770 393	VXREKV1	794 358	VVLA46C	795 325	VRN7PRE
743 250	VP6YV4T	750 356	VVHHBRA	770 060	VGU6HRH	770 604	VTCS2XV	794 359	VU3KD1Q	795 331	VKVA6E5
743 325	VQKTK4T	750 357	VYS9QVG	770 061	V37GK1H	770 802	VJKLDM9	794 360	VPXL118	795 350	VVUD5DD
743 335	VN63A91	750 358	VZGZMYB	770 064	VM8AMR1	770 803	VN9BS4D	794 362	VY3ARQW	795 351	VNH1BXX
		750 359	V2YMX28	770 065	VZ5R8NL	770 804	VZLCL8A	794 363	VFDY3DQ	795 356	V5J66JU
745 426	VSUN6NV	750 360	VRCU995	770 068	VQBKB5F	770 806	VV2HPN4	794 365	V8RTUHC	795 357	VNY25QX
745 436	VSHDQZB	750 362	VNYZ52U	770 069	VPPD4XQ	770 807	VJBA1NB	794 366	VSFQ9ZG	795 358	VD6S3TM
745 458	VUKMT58	750 363	V1TGQ4X	770 103	VWZV92M	770 811	VR5YMHR	794 367	VA72VVU	795 359	VCB21XA
745 459	V3RQASE	750 365	VLJNZWC	770 104	VLBNNQ8	770 812	VNYRU9G	794 368	VAEJGBQ	795 360	V2WYQC1
745 460	VD22VDX	750 366	VGPZPDH	770 105	V1RE55J	770 813	VVWUEFN	794 369	V4JDGS2	795 362	VZEUA2A
745 816	VS29AH	750 367	VPJMGKF	770 106	VT4G9E6	770 815	VJV9F84	794 370	VBTY7PB	795 363	VVKV3DN
745 817	V1RC3P2	750 368	VQM3HNW	770 107	VEW85JV	770 816	V9FXVRN	794 372	V5QGZHZ	795 365	VYFU66X
745 925	V162LDM	750 369	VTW95D3	770 110	VS2F8V2	770 821	VMPFLNJ	794 373	VAME5X5	795 366	VL61UF3
745 926	VMRSJWD	750 370	VVVK1JQ	770 112	VBP68R	770 822	VEJCSDF	794 375	V5DYR2W	795 367	VKPDYFL
745 935	VE5K3HM	750 372	V9XQCNN	770 113	V3E3D6R	770 823	VK6ESW9	794 376	VDEFR59	795 368	VDNB939
745 936	VEH4JQY	750 373	VM2NED8	770 114	V5VJ95Y	770 825	VXPMZAD	794 377	VXDR81Q	795 369	VBSVW4J
745 940	VZPW9LG	750 375	VNTCK8P	770 123	VZAN94L	770 826	VFTAWJF	794 378	VA2225Y	795 370	VCDBKRZ
		750 376	VDRNJ2S	770 125	VFJ44TW	770 831	V1JTFDE	794 379	VZXJ2FA	795 372	V5TTTRS
750 025	VBAAV8C	750 377	VKJV3VM	770 127	V22Y229	770 832	VDV4LWB	794 380	VHEF76J	795 373	VDS53CN
750 031	VJSM52N	750 378	VTQTSQV	770 134	VMVRJEM	770 833	VCY38F6	794 382	VCN3NCE	795 374	VR32NHV
750 044	VKCP5AF	750 379	VNV2RG2	770 135	V2TLVK7	770 835	V4RJ7A2	794 383	V5FP1GU	795 375	V6DHU7
750 045	VMN4GDZ	750 380	VJUSUHD	770 138	VJWZJ3G	770 836	VX5JF6F	794 385	VL57XQ9	795 376	VG13KVF
750 046	VBK1GY5	750 382	VVZLD6Y	770 139	V2TSJVZ			794 386	VKMPATQ	795 378	V97KK63
750 048	VUJZT545	750 383	VFMDAKW	770 317	V2FEYLZ	776 412	V797FE6	794 387	VLXJ3LH	795 379	VQ8FYQU
750 049	VALQ5Y4	750 385	V4VEYJU	770 325	VLU29GH	776 415	VB53TC9	794 388	VL8T7HK	795 380	VQWUXJD
750 050	VB9YGVW	750 386	VQGRY7F	770 331	VAEP8C2	776 425	VSY71K4	794 389	VBJGR5A	795 382	VLQY6LG
750 052	V5MJ1D4	750 387	V4HCYVD	770 350	VQYP8B2	776 435	V9JF26K	794 390	VJHAN6V	795 383	VF3L4VY
750 053	V8Z7P3F	750 388	VTFCTME	770 351	VM8PZQW	776 450	VRJG23Y	794 392	V1E2MDU	795 384	VZFAZME
750 060	VFHAVQS	750 389	V6SP1XB	770 353	VCV465D	776 470	VPZBBSL	794 393	V7WX8SR	795 385	VM1A6BG
750 061	VVCR31N	750 390	V5KBVJ9	770 354	V1SEZ7V	776 495	VZC3FST			795 386	V4NWSAD
750 063	VZWBHCN	750 392	V3NYZMV	770 356	VCQPRBW	794 025	VBSMFKC	795 025	VL2SENN	795 388	V2AJRXP
750 064	VUZ8MS2	750 393	V29HNHP	770 357	V8BHQB8	794 031	VDFWBWD	795 031	VQ5P928	795 389	V62YAXX
750 065	V8YNRNE	750 604	VN35H5D	770 358	VLGTEJU	794 044	VXQCVCN	795 038	V7M4G4Y	795 390	V81BD5Y
750 067	VX8CUBA	750 802	V37MFYV	770 359	VXG61F5	794 045	V4J9UXX	795 039	VDT3T2Z	795 392	VVH5CZ1
750 068	V4SLGNC	750 803	VVB5WXA	770 360	VHEHJXY	794 046	VR8356V	795 041	V356C5K	795 393	VBQG7FR
750 069	VDSMJ3S	750 804	VUFEJRS	770 362	VY7DCHG	794 048	VMC9DQV	795 042	VX8NNWD	795 604	VLB2F3G
750 101	VTZD7GJ	750 806	VS2K1LW	770 363	VG5HBEM	794 049	VVLHVTC	795 043	VFPDUFB	795 802	V56B2KD
750 103	V9L1MTM	750 807	VHLFKA8	770 365	VJAPTE4	794 050	VJVK21S	795 044	VFA5K2X	795 803	VBSK4M8
750 104	V7V4L8U	750 811	VV2ZFCE	770 366	VRAPPLM	794 052	VV8VRZH	795 045	VAV834Q	795 804	VRZKGQ9
750 105	VEEP6AW	750 812	VQAUPLL	770 367	VB4G2U9	794 053	VSEX7VE	795 046	V4H5CJH	795 806	VETJPMF
750 106	V7ETTH4	750 813	VEEKVNP	770 368	VGEGSMA	794 060	V9HUZQM	795 048	V67JB8K	795 807	V1QKPL1
750 107	VD68BWT	750 815	V9P37D2	770 369	VF5G9V2	794 061	VU6CUGZ	795 049	VX11PRS	795 811	VFE63YT
750 108	VKAMEV6	750 816	V2X4BT2	770 370	V1JF2W8	794 064	V67KLG2	795 050	VYVR9QF	795 812	V3CX3D
750 110	VAB24MU	750 821	VTF714Z	770 372	VHMKBDN	794 065	V536XJY	795 053	VA64F22	795 813	V5UYSYN
750 112	VRPVAYL	750 822	VPXTVLH	770 373	VHTU76U	794 068	VK69GAC	795 060	VYXJE79	795 815	VCXK4CS
750 113	VK7856S	750 823	VVBEEYR	770 375	VA3FMB1	794 069	VBZ9QTH	795 061	VPR2BV4	795 816	VCZ332G
750 114	VFQE9GC	750 825	VARQN3A	770 376	VJUUVQ2H	794 125	VEYAYGD	795 064	V96XGRY	795 821	VC51J3J
750 123	VVQ8G74	750 826	V5AC9LR	770 377	VAKDTQ8	794 127	V1K5YTF	795 065	V5VTF1M	795 822	VY1X9QL
750 125	VBC3ZW8	750 831	V3NXQPG	770 378	VBLEQAT	794 134	V9SQTQM	795 068	V5UZSH7	795 823	VRCW7VG
750 127	VGYM5TJ	750 832	VKFT31E	770 379	VFKR4Y7	794 135	VXS9KPS	795 069	VW3UYUB	795 825	VZV74Y2
750 132	VA4T7G7	750 833	VBU3KP2	770 380	VK8HC15	794 138	V7LQTFV	795 103	VPUDKFT	795 826	VY3YS93
750 134	V64BSPZ	750 835	VMBDCM1	770 382	VTEY43R	794 139	VLWG7T3	795 104	VN9HWC2	795 831	V1Y86WG
750 135	VKREU61	750 836	VFGTQXS	770 383	VG73XL3	794 317	V4NRQE1	795 105	V7PN1G9	795 832	VT3J1P4
750 136	V1GQJTW			770 385	VB3QZ96	794 325	VQUNKCZ	795 106	V65RR5D	795 833	VAMMRBG
750 138	VCBZM3C	770 025	VZ6JQNW	770 386	VYGUWYZ	794 331	VVK556A	795 107	VRQD6H2	795 835	VRAB9WB
750 139	V484AUS	770 031	VRVY69X	770 387	VLGHLHM	794 350	V5SVXPH	795 110	VBX7XDG	795 836	VJ1PKY1
750 317	VK3UPSM	770 044	VSJKZDX	770 388	VK7X51U	794 351	VCH8YCP	795 112	VZA7PEZ	795 950	V64V85W
750 325	VLCRPCB	770 045	VEAN8EN	770 389	VZMPSQE	794 353	V31U99G	795 113	V52GS6X	795 951	VT9FREL
750 331	VKVTFX2	770 046	VM19WAG	770 390	VL67HCY	794 354	VTR7ZZD	795 114	VG6A9D2		
750 350	VD28FAD	770 049	V1SCQ5Z			794 355	VW3DBLC	795 123	VJ4VQVZ		
750 351	VUCHGY5										

## Key Words

Product	Page	Product	Page	Product	Page
Accessory for NS and MS Cleaning Kits	143	Field Sensor	199	PHE III ZK Indicator with Test Prod	16
Adapter	205	Fixed Ball Points	76/183	PHE III ZK Voltage Detector	14
Application of Voltage Detectors	10	Fixed Ball Points for round Conductors	79	PHE III ZK Voltage Detector Kit	18
Arc-fault-tested Face Shield	151	Fixed Earthing Points	81	PHG II Voltage Detector	29
Artificial Leather Bag	191	Fixed Earthing Points with Ring Groove	80	PHE/G d.c. Voltage Detector	30/170
ASP Non-Contact Voltage Detector	26	Fixed Phase Points	83	Phase Connecting Elements	180
ASP Non-Contact Voltage Detector Kit	169	Four-pole to six-pole Earthing and Short-Circuiting Devices	120	Phase Connecting Elements for Overhead Lines	96
Ball Head Cap	91/99	FRS ZK MS Damp Cleaning Kit	137	Phase Connecting Elements for Overhead Lines up to Ø85 mm	92
Battery	209			Phase Connecting Elements for Overhead Lines up to Ø25 mm	94
Canvas Bag	192	Handles and Extensions	204	Phase Connecting Elements for Switchgear Installations	90
Clamp for Railway Tracks	181	HSA 194 Non-Contact Voltage Detector	168	Plastic Case	189
Conductor Clamp	180	HSA 205 High-Voltage Indicator	28	Pneumatic Glove Tester	155
Covering Material and insulated Mats	158	Indicators	200	PPE – Personal Protective Equipment	154
		Indicator with Test Prod	200	Probes	198
DEHN – worldwide	5	Installation Devices	208		
DEHN – Keeping you informed	6	Insulating Elements	203	RST Rescue Rods	60
DEHNcap HR – LRM Test Set	45	Insulating Equipment for Airport Lighting Systems	156	Safety Helmet for Electricians	151
DEHNcap Test Adapter /Measuring Impedance	46	Insulating Gloves	155	SCS Switching Sticks	57
DEHNcap/A Voltage Indicator	42	Insulating Protective Shutters	61	SCS Switching Sticks with Silicon Rubber Insulator	56
DEHNcap/IT Interface Test Unit	43	Insulating Stick Kit for Cleaning the Windscreens of electric Locomotives	185	SDS	186
DEHNcap/P Test Unit	41	Insulating Sticks	202	Sheet Metal Case	188
DEHNcap/P Voltage Indicator	40	IS Insulating Sticks	54	Short-Circuiting Bar	84
DEHNcap/PC-LRM Phase Comparator	44	IS Insulating Sticks with Silicon Rubber Insulator	52	Single-Part Earthing Sticks for Switchgear Installations	102
DEHNcare APG – Protective gloves	152	IS STK Insulating Stick Kit with Silicon Rubber Insulator	48	Single Parts for MS Cleaning Kit	139
DEHNcare APS and ESH	150	IS STK Insulating Stick Kit	50	Single-pole Earthing and Discharge Devices	125
Design of DEHNcap Voltage Detecting Systems	37	IW insulated Platform	157	Single-pole PHV I Phase Comparator	36
Design of Phase Comparators	33			Spare Parts	209
Design of Voltage Detectors	9	Kit for Construction Machines, Lifting Gear, Maintenance Vehicles	177	Special Screw Plugs	148
		Kit for electric Point and Train Pre-Heating Systems	178	Storage Devices	206
Easy Choice – Earth Connecting Elements	111	Kit for Overhead Contact Lines	174	SZ Fuse Tongs	58
Easy Choice – Phase Connecting Elements and Earthing Sticks	110	Kit for Towers	176		
Easy Choice – Storage Bags and Transport Cases	193	Live Working Product Range	129	Telescopic Earthing Sticks for Overhead Lines	105
Earth Clamp for Overhead Contact Lines	180	Lock-out Systems	160	Template for Insulating Protective Shutters	66
Earth Connecting Elements	181	Maintenance tests	7	Template for portable Earthing and Short-circuiting devices	109
Earth Connecting Elements – Universal Earth Clamps	98	MS Screw Driver Set	146	Template for Short-circuiting Bars	86
Earth Connecting Elements – Ball Head Caps	99	Multi-Part Earthing Sticks for Overhead Lines	107	Tests for our Safety Equipment	8
Earth Connecting Elements – Earth Connectors	100	NFG MS Refilling Device	144	Test Prods for PHE III and PHE Voltage Detectors	197
Earth Connecting Elements – Earth Milling Clamps	101	NH Fuse Puller with Sleeve	154	Three-pole Earthing and Short-Circuiting Kit TI	116
Earth Connecting Plates	82			Three-pole Earthing and Short-Circuiting Kit VI	114
Earth Connecting Plate and Terminal Lug	184	Operating Heads	201	Three-pole Earthing and Short-Circuiting Devices for crane conductor bars	119
Earthing and Short-Circuiting Cables, unequipped	87	PHE Voltage Detector	24/165	Three-pole Earthing and Short-Circuiting Kit for Street Lighting Systems	121
Earthing and Short-Circuiting Configurator: Easy online Configuration	73	PHE Voltage Detector Kit	162	TFRS MS Combined Cleaning Kit	138
Earthing and Short-Circuiting Devices	69/178	PHE III Voltage Detector	164	TRS MS Dry Cleaning Kit	135
Earthing Cable in accordance with IEC 61138	89	PHE III Voltage Detector Kit	167	TRS NS Dry Cleaning Kit	132
Earthing Handle	122	PHE III M12 Voltage Detector	12	Two-Part Earthing Sticks for Switchgear Installations	104
Earthing Kit	97	PHE III M12 / ZK Voltage Detector Kit	20	Two-pole PHV Phase Comparator	34
Earthing Sticks	182			Two-pole SPN Voltage Detector	123
Electrodes	196				
End Fittings	205			Universal Earth Clamps	98





Surge Protection  
Lightning Protection  
Safety Equipment  
DEHN protects.

DEHN + SÖHNE  
GmbH + Co.KG.

Hans-Dehn-Str. 1  
Postfach 1640  
92306 Neumarkt  
Germany

Tel. +49 9181 906-0  
Fax +49 9181 906-1444  
export@dehn.de  
www.dehn.de