



# Red/Line Selection Guide

Surge Protection for Power Supply Systems



# Power Supply Systems Worldwide

## International system configurations\* according to IEC 60364-1 (DIN VDE 0100-100)

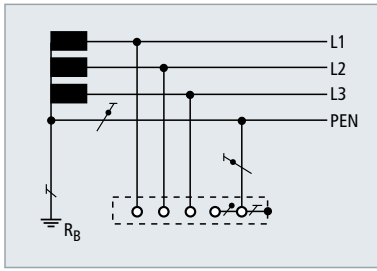

**TN-C system** 230 / 400 V

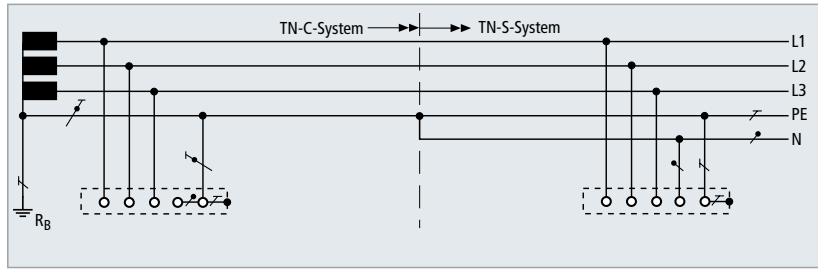

**TN-C-S system** 230 / 400 V

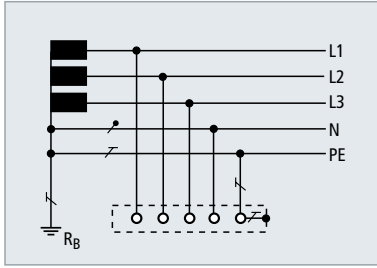

**TN-S system** 230 / 400 V

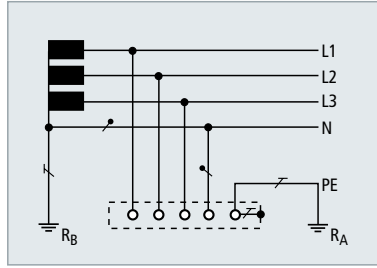

**TT system** 230 / 400 V

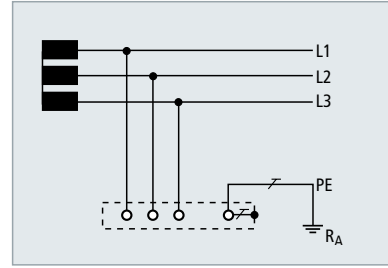

**IT system** 230 V, 400 V, 500 V, 690 V

## Further system configurations\* used worldwide

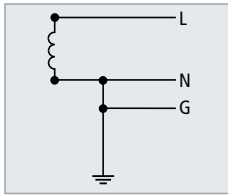

**single-phase; 3 conductors**

(1 Ph, 2 W + G)  
110 V  
120 V  
220 V  
240 V

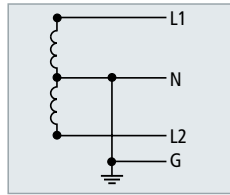

**single-phase; 4 conductors**  
Split Phase or Edison

(1 Ph, 3 W + G)  
120 V / 240 V

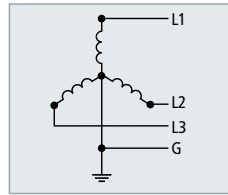

**3-phase; 4 conductors**

(3 Ph Y, 3 W + G)  
480 V

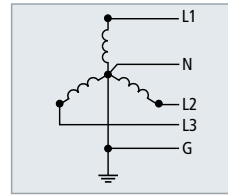

**3-phase; 5 conductors**

(3 Ph Y, 4 W + G)  
120 V / 208 V  
277 V / 480 V

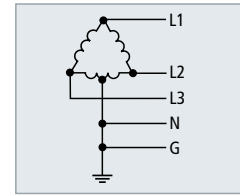

**3-phase; 5 conductors**  
Delta "Highleg"

(3 Ph Δ, 4 W + G)  
120 V / 240 V

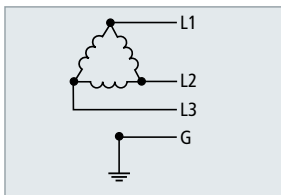

**3-phase; 4 conductors**  
Delta "Ungrounded"

(3 Ph Δ, 3 W + G)  
240 V  
480 V

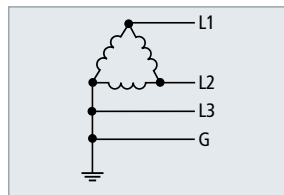

**3-phase; 4 conductors**  
Delta "Grounded Corner"

(3 Ph Δ, 3 W + G)  
240 V  
480 V

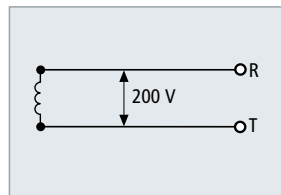

**single-phase; 2 conductors**

(1 Ph, 2 W)  
200 V

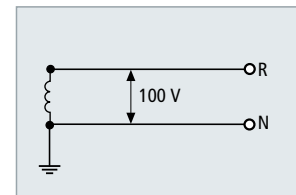

**single-phase; 2 conductors**

(1 Ph, 2 W)  
100 V

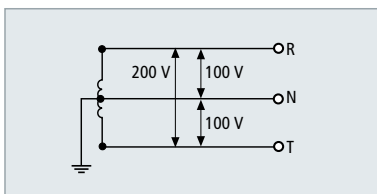

**single-phase; 3 conductors**

(1 Ph, 3 W)  
100 V / 200 V

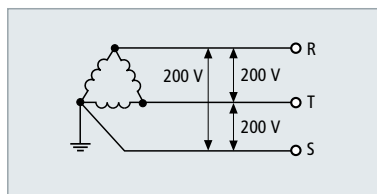

**3-phase; 3 conductors**

(3 Ph, 3 W)  
200 V

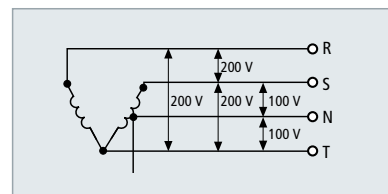

**3-phase; 3 conductors**  
+ single-phase; 3 conductors

100 V / 200 V; 200 V

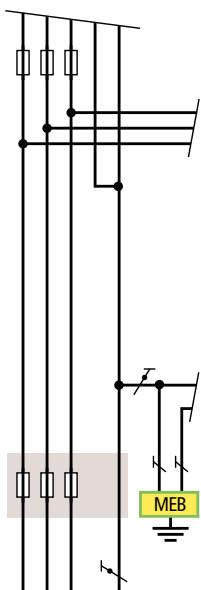
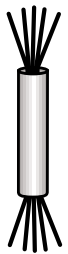
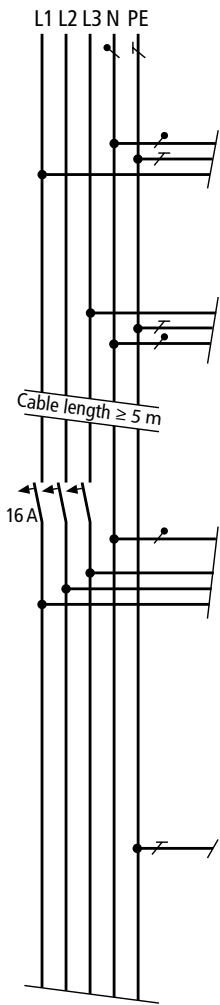

L1 L2 L3 PEN

**SPD Type 3  
(Surge arrester)**

1 x DSA 230 LA for cable ducts Part No. 924 370

**SPD Type 3  
(Surge arrester)**

1 x DFL M 255 for flush-mounted systems Part No. 924 396

**SPD Type 3  
(Surge arrester)**

1 x STC 230 for existing socket outlets Part No. 924 350

Socket Outlet

**SPD Type 2  
(Surge arrester)**

1 x DG M TNS 275 Part No. 952 400

**SPD Type 2  
(Surge arrester)**

with remote signalling contact:  
1 x DG M TNS 275 FM Part No. 952 405

Sub-distribution Board

**Cable length ≥ 15 m**

**DEHNbloc® M**  
Coordinated with DEHNgard®  
without additional cable length.

**DEHNventil®**  
Directly coordinated with  
Red/Line SPDs Type 2 and 3  
without additional cable length.

For series connection please see also page 6

**SPD Type 1  
(Lightning current arrester)**

1 x DB 3 255 Part No. 900 120  
alt. 3 x DB 1 255 H Part No. 900 222  
1 x MVS 1 6 Part No. 900 815

**SPD Type 1  
(Coordinated lightning current arrester)**

3 x DB M 1 255 FM Part No. 961 125  
1 x MVS 1 6 Part No. 900 815  
alt. 3 x DB M 1 255 Part No. 961 120  
1 x MVS 1 6 Part No. 900 815

**SPD Type 1  
(Combined lightning current and surge arrester)**

1 x DV M TNC 255 Part No. 951 300  
alt. 1 x DV M TNC 255 FM Part No. 951 305  
also available as  
1 x DV M TNS 255 Part No. 951 400  
alt. 1 x DV M TNS 255 FM Part No. 951 405

Main Distribution Board

1) Only required, if no fuse of the same or a lower nominal value is provided in the upstream power supply.

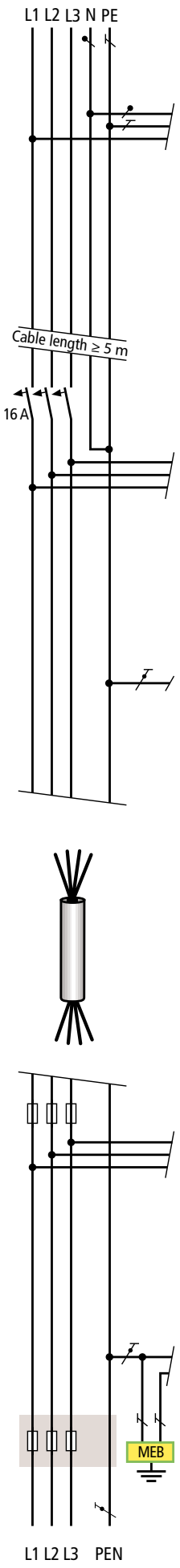

**SPD Type 3  
(Surge arrester)**

1 x NSM PRO EW Part No. 924 342

**SPD Type 3  
(Surge arrester)**

1 x DPRO 230 F Part No. 909 240  
1 x DPRO 230 Part No. 909 230

**SPD Type 3  
(Surge arrester)**

1 x SFL PRO 6X Part No. 909 250

Socket Outlet

**SPD Type 2  
(Surge arrester)**

125 A 1

1 x DG M TNC 275 Part No. 952 300

**SPD Type 2  
(Surge arrester)**

125 A 1

with remote signalling contact:  
1 x DG M TNC 275 FM Part No. 952 305

fault indication

Sub-distribution Board

Cable length ≥ 15 m

**DEHNbloc<sup>®</sup> M**  
Coordinated with DEHNguard<sup>®</sup>  
without additional cable length.

**DEHNventil<sup>®</sup>**  
Directly coordinated with  
Red/Line SPDs Type 2 and 3  
without additional cable length.

For series connection please see also page 6

**SPD Type 1  
(Lightning current arrester)**

315 A 1

3 x DBH M 1 255 Part No. 961 122  
1 x MVS 1 6 Part No. 900 815

alt. 1 x DB 3 255 H Part No. 900 120

**SPD Type 1  
(Coordinated lightning current arrester)**

315 A 1

3 x DBH M 1 255 FM Part No. 961 125  
1 x MVS 1 6 Part No. 900 815

alt. 3 x DBH M 1 255 Part No. 961 120  
1 x MVS 1 6 Part No. 900 815

fault indication

**SPD Type 1  
(Combined lightning current and surge arrester)**

315 A 1

1 x DV M TNC 255 Part No. 951 300

alt. 1 x DV M TNC 255 FM Part No. 951 305

Main Distribution Board

1) Only required, if no fuse of the same or a lower nominal value is provided in the upstream power supply.

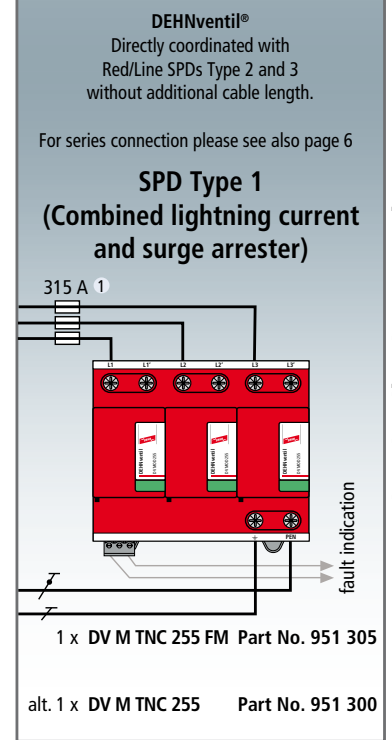
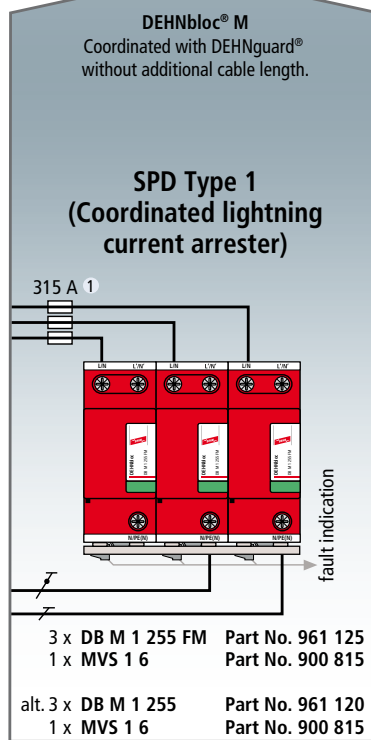
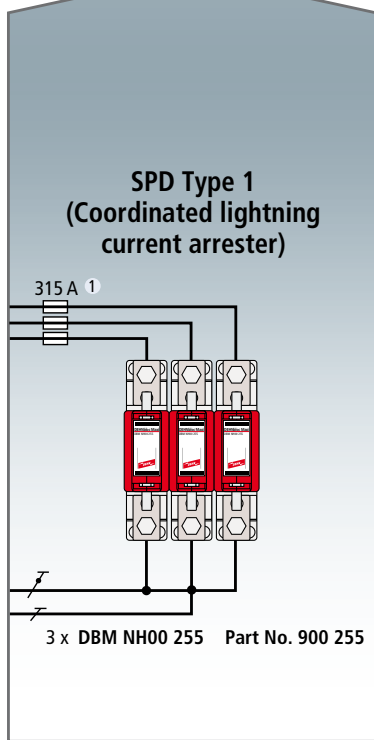
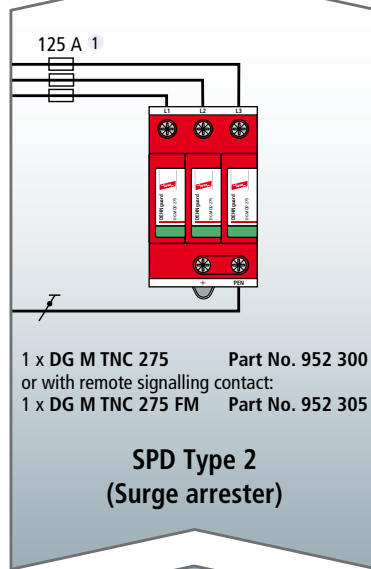
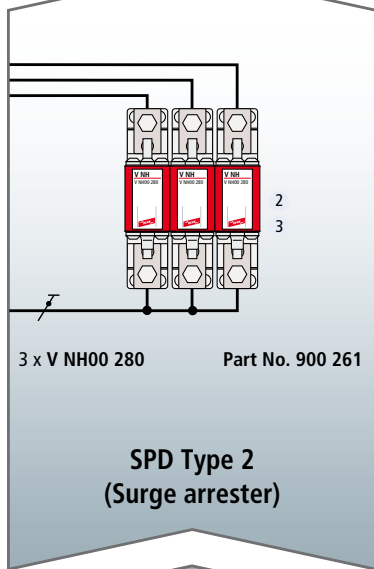
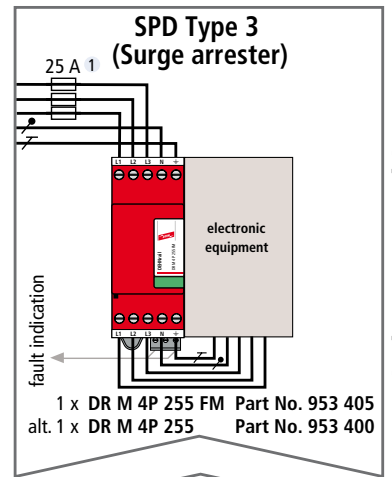
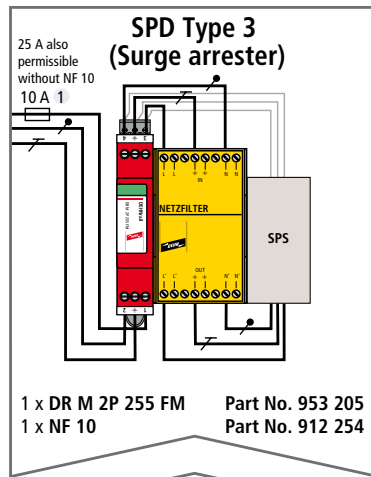
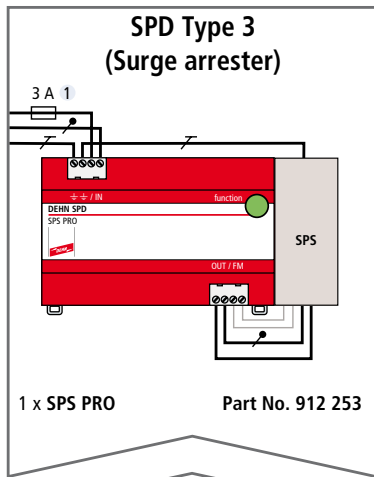
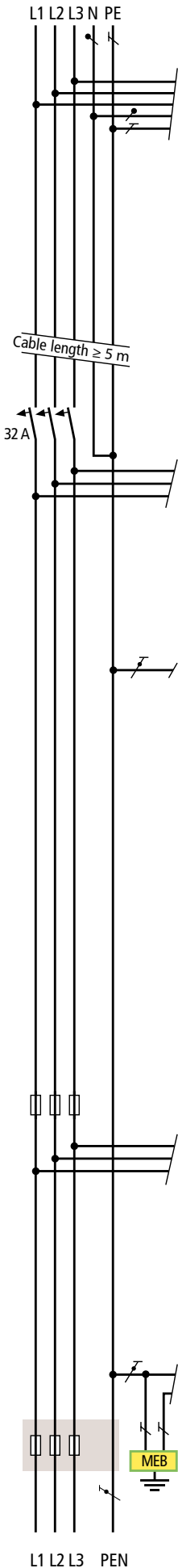

Switchgear / Machine

Sub-distribution Board

Main Distribution Board

- 1) Only required, if no fuse of the same or a lower nominal value is provided in the upstream power supply.
- 2) Without separate backup fuse in case of earth-fault and short-circuit-proof installation.
- 3)  $I_k \leq 25 \text{ kA}_{\text{rms}}$

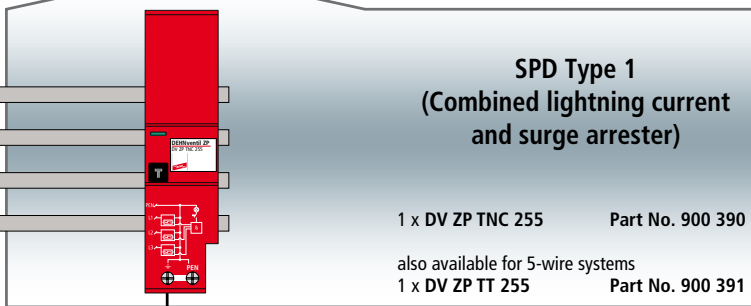
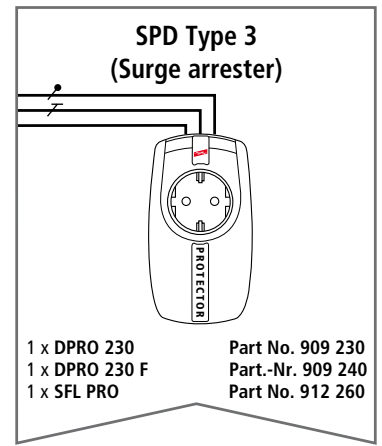
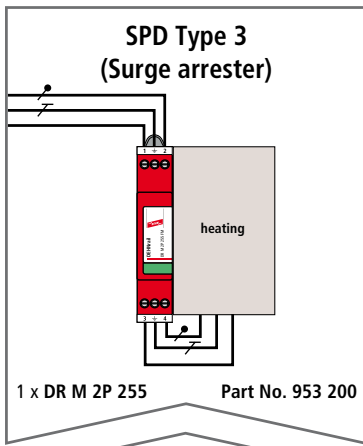
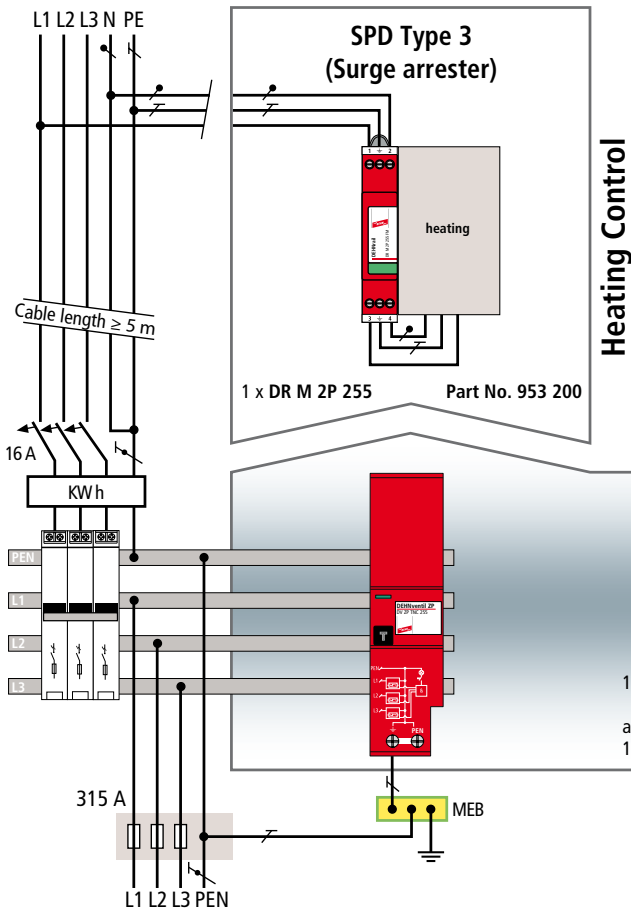

**Note:**  
As an alternative, surge arresters can also be used downstream of meter panels (e.g. DG M TNC 275 Part No. 952 300) if there is no

- lightning protection system
- electrical power supply by the service entry mast
- antenna of the roof

– if none of the conditions mentioned above apply to an adjoining building

**TN system:** Example: Single-family house

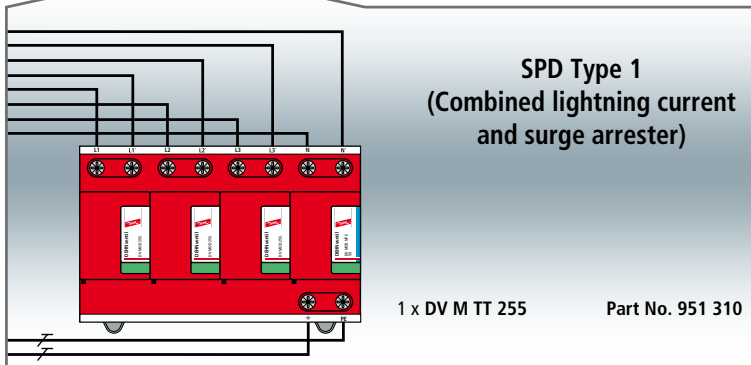
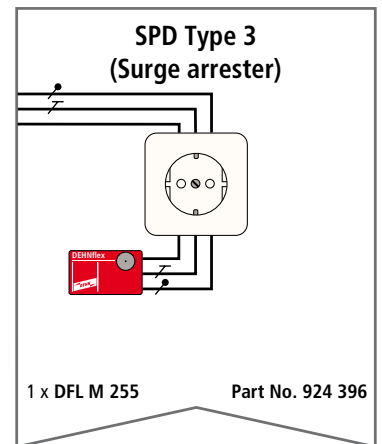
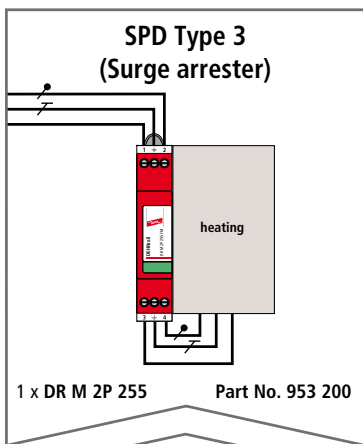
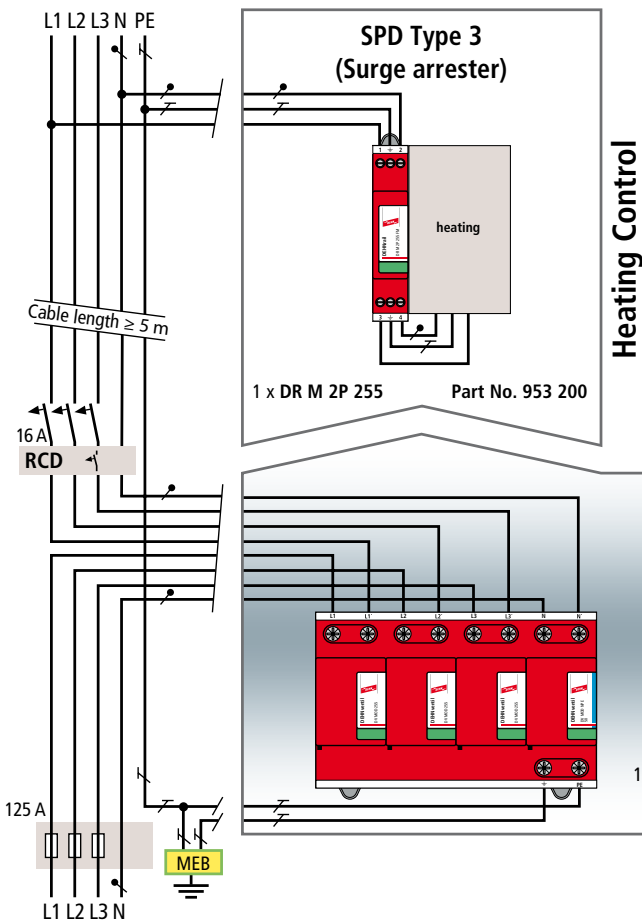

**Note:**  
As an alternative, surge arresters can also be used downstream of meter panels (e.g. DG M TT 275 Part No. 952 310) if there is no

- lightning protection system
- electrical power supply by the service entry mast
- antenna of the roof

and if none of the conditions mentioned above apply to an adjoining building.

**TT system:** Example: Single-family house

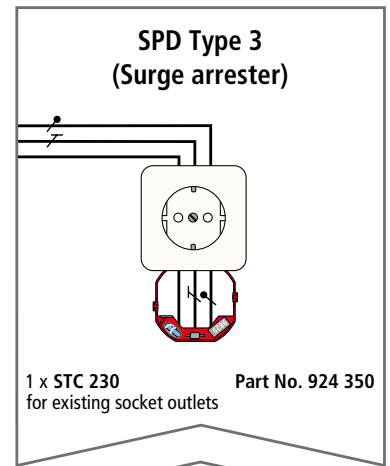
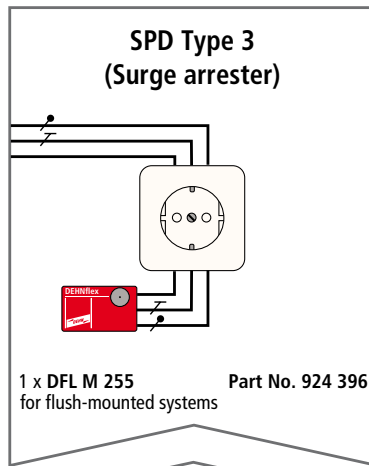
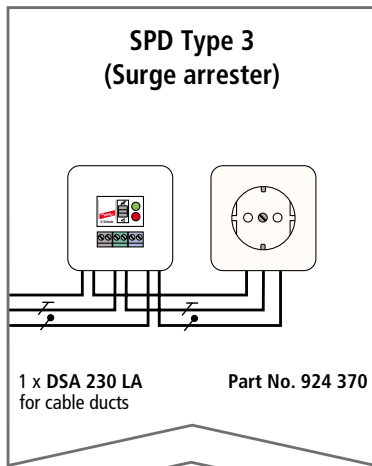
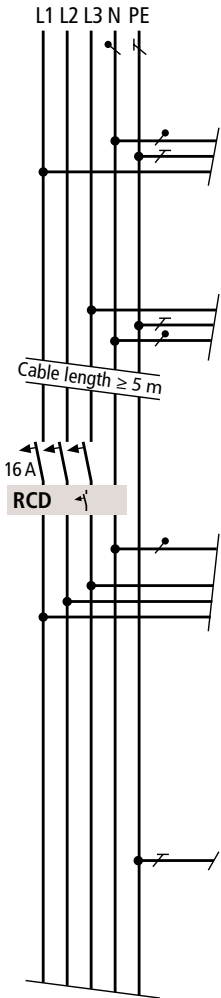

Socket Outlet

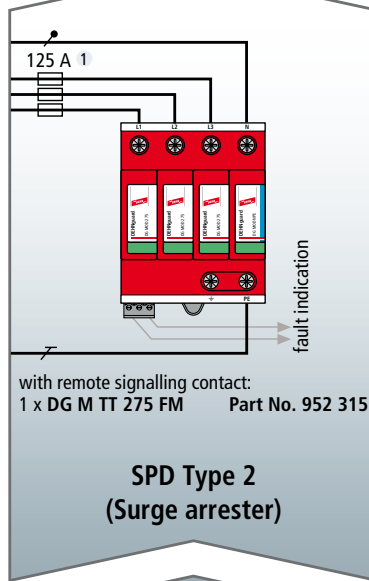
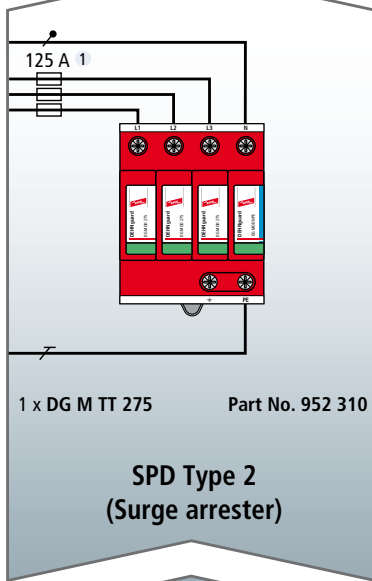

Sub-distribution Board

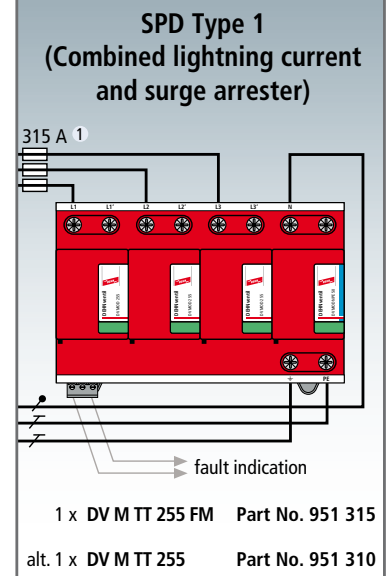
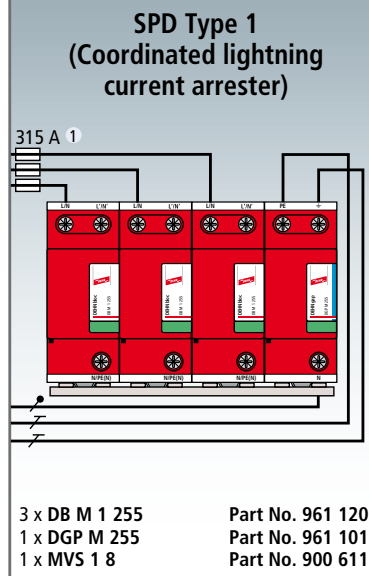
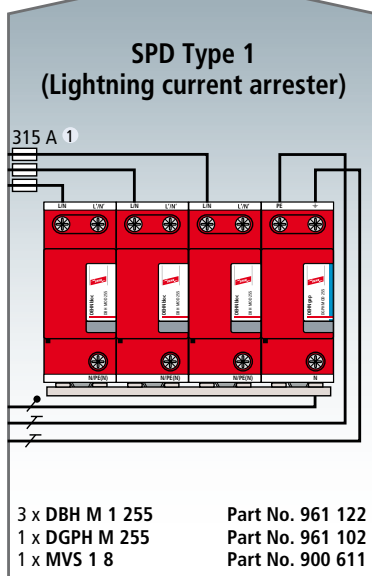
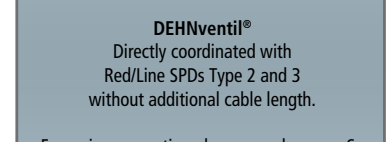
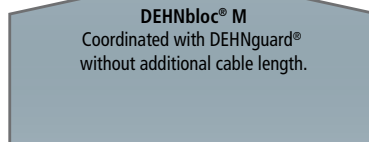
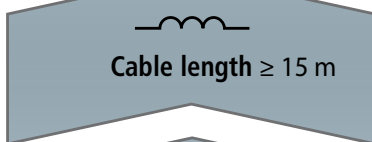

Main Distribution Board

1) Only required, if no fuse of the same or a lower nominal value is provided in the upstream power supply.

L1 L2 L3 N

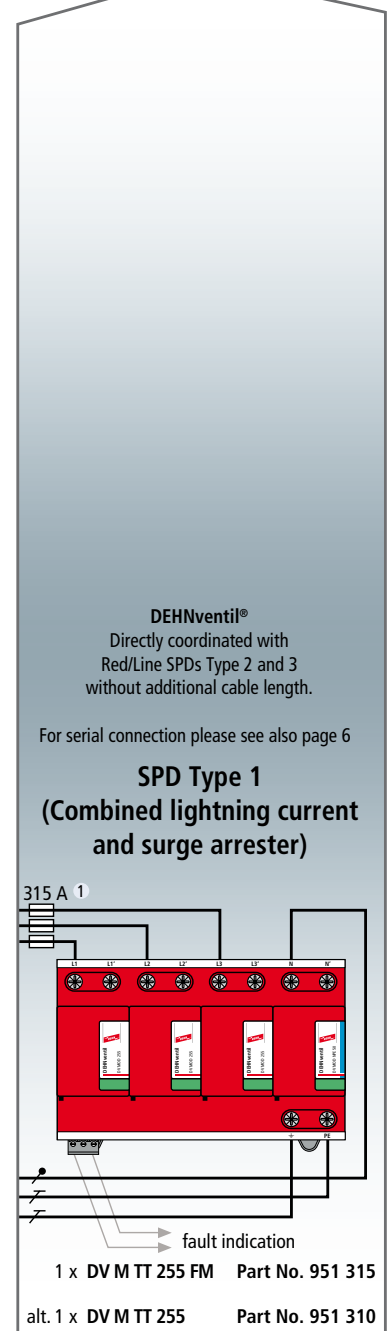
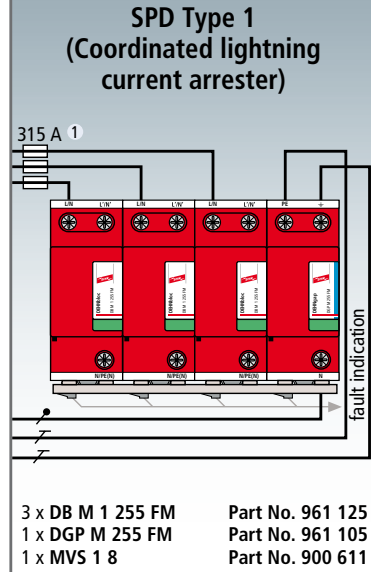
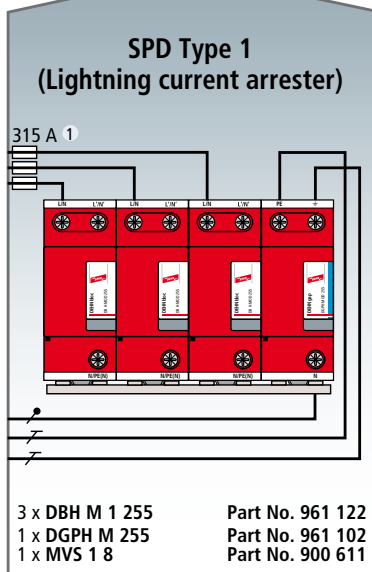
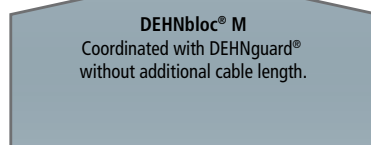
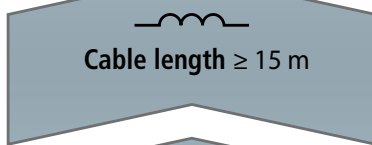
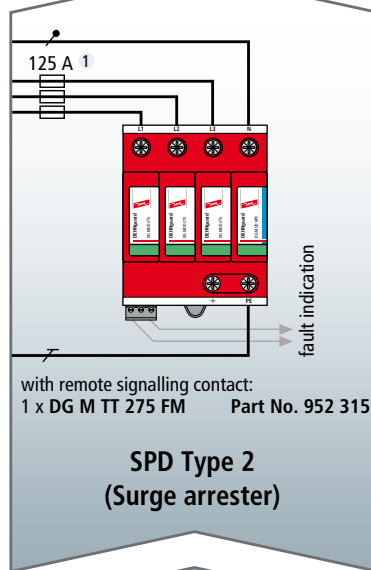
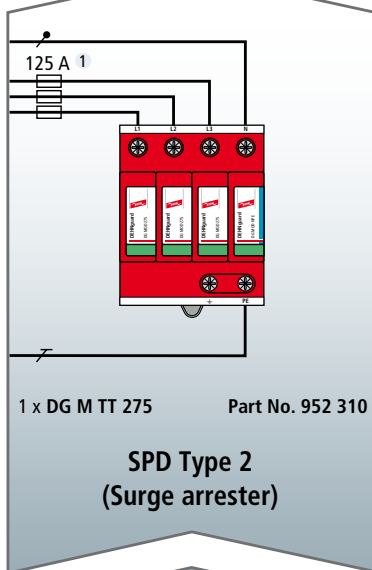
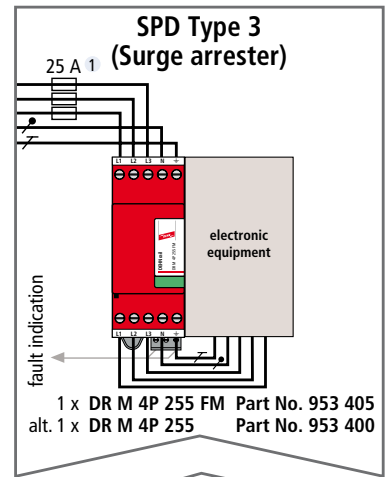
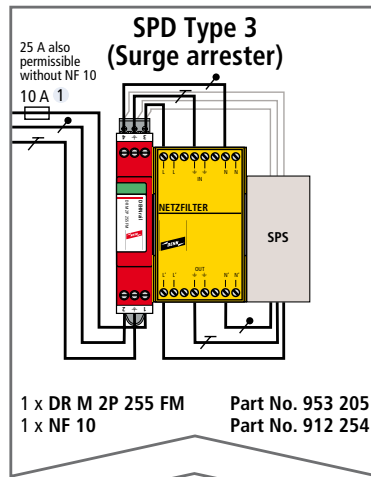
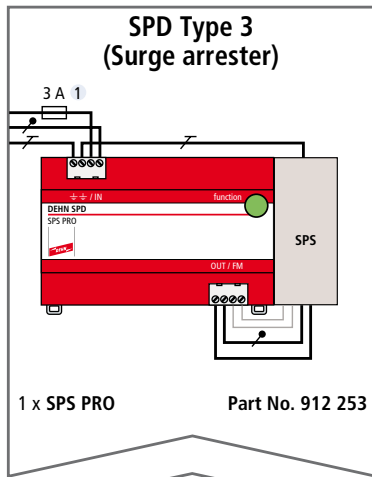
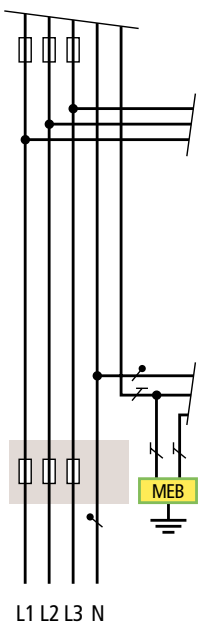
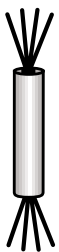
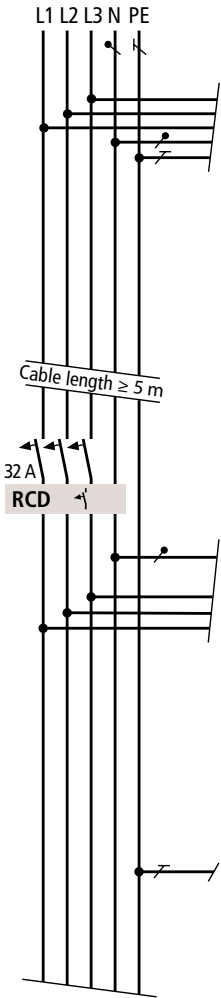

Switchgear / Machine

Sub-distribution Board

Main Distribution Board

1) Only required, if no fuse of the same or a lower nominal value is provided in the upstream power supply.



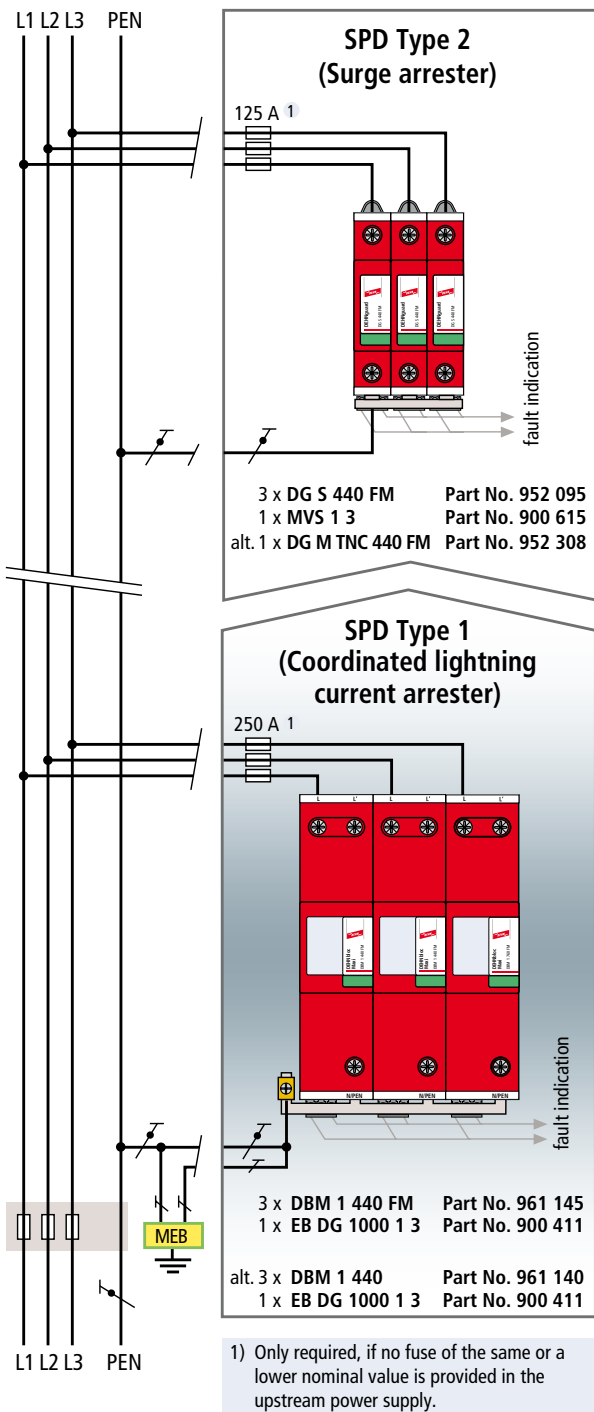

**TT system:** Industrial building TN-C 400/690 V

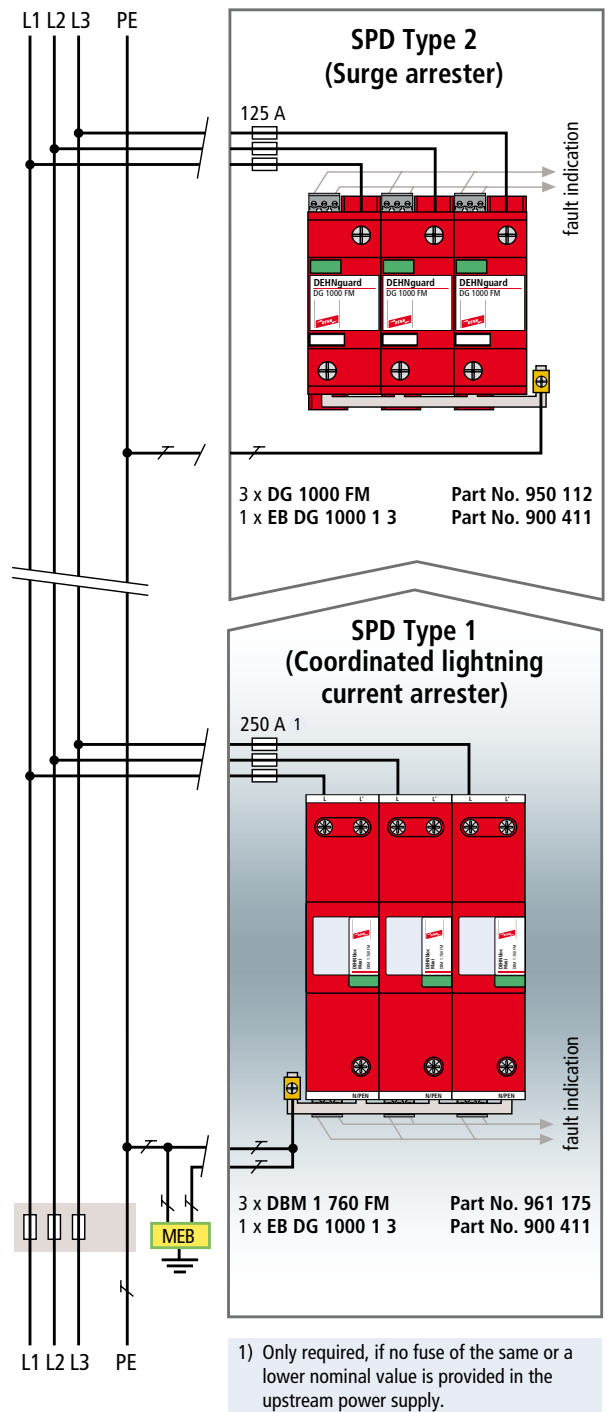

**IT system:** Industrial building IT 690 V, without integrated neutral conductor

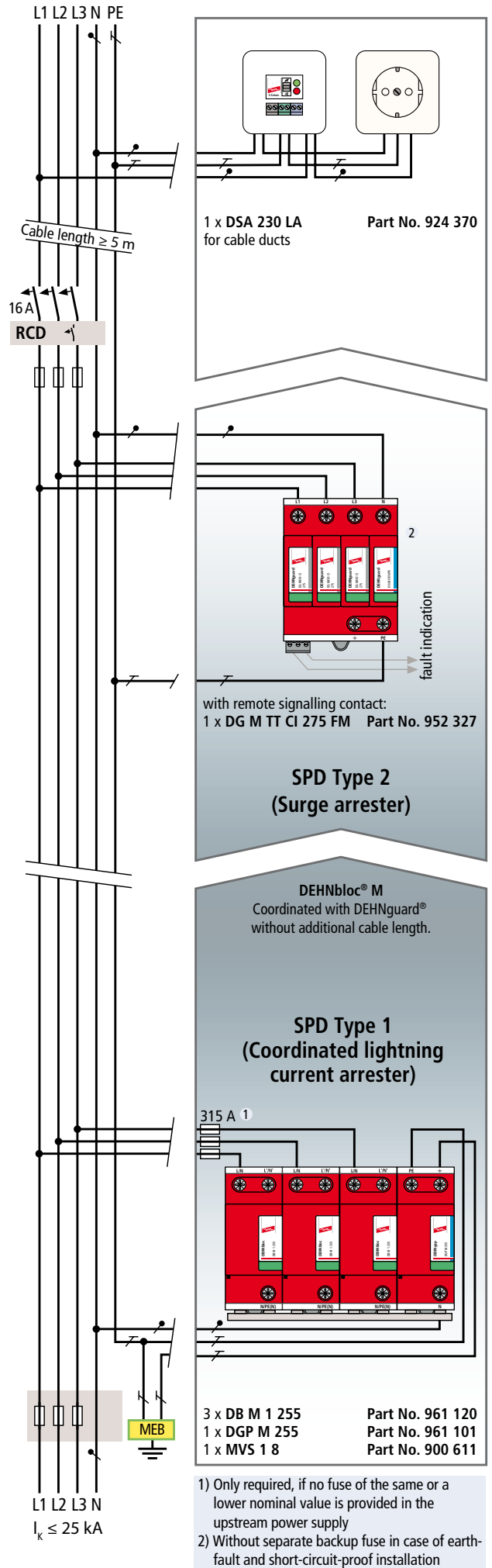
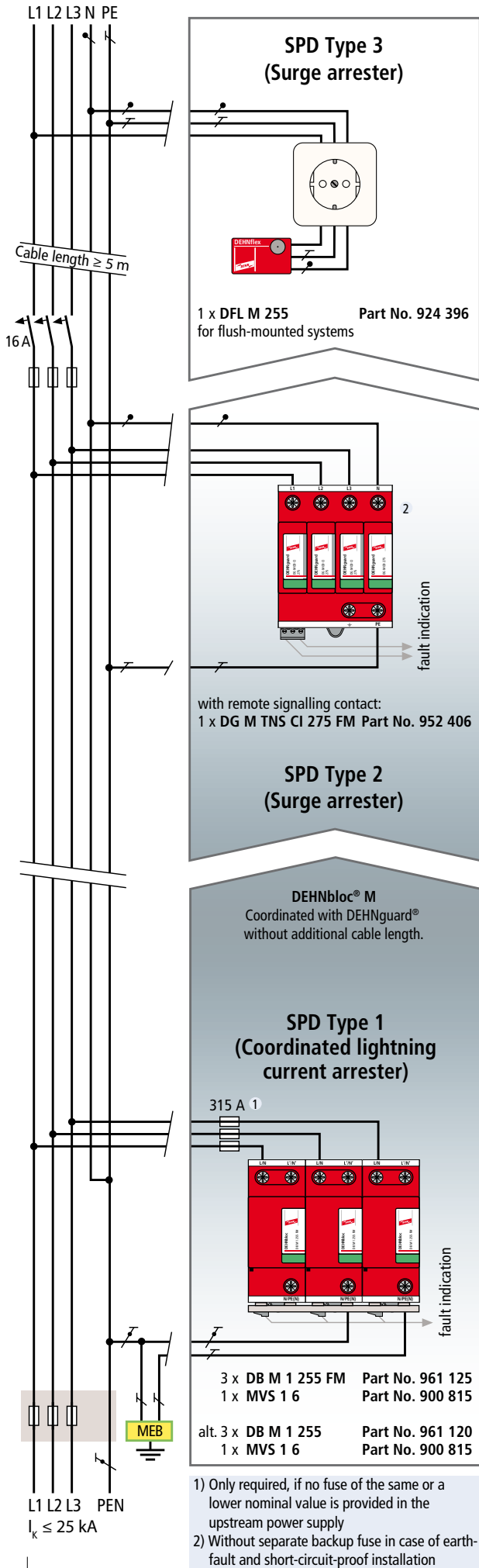

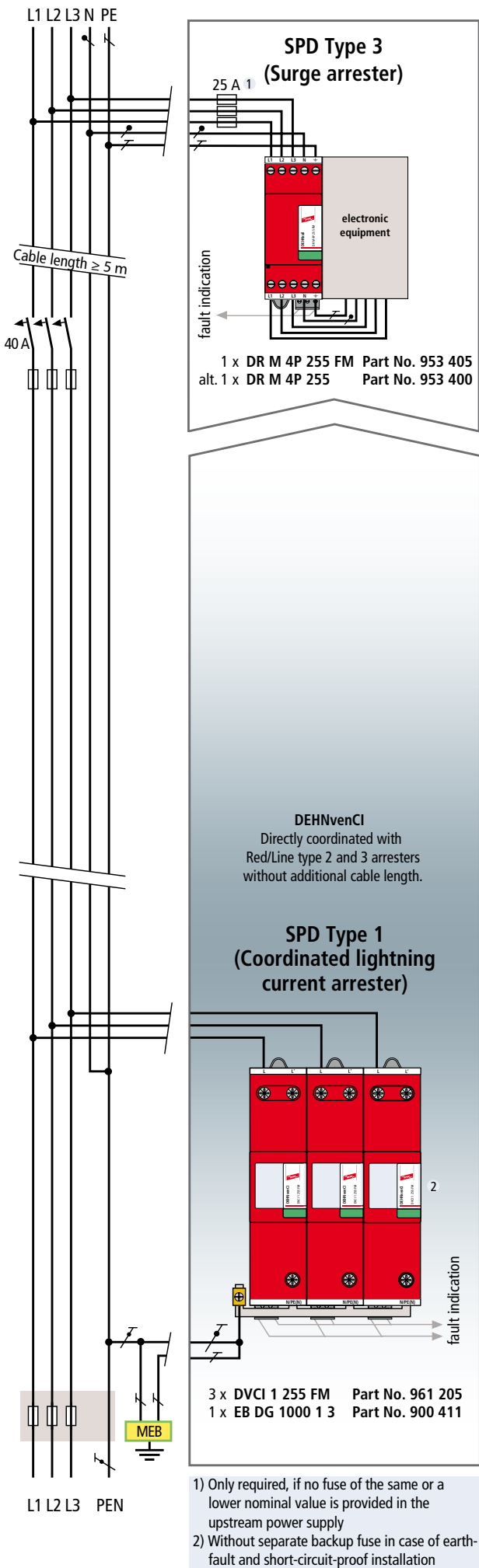

**Switchgear / Machine**

**Main Distribution Board**

- 1) Only required, if no fuse of the same or a lower nominal value is provided in the upstream power supply
- 2) Without separate backup fuse in case of earth-fault and short-circuit-proof installation

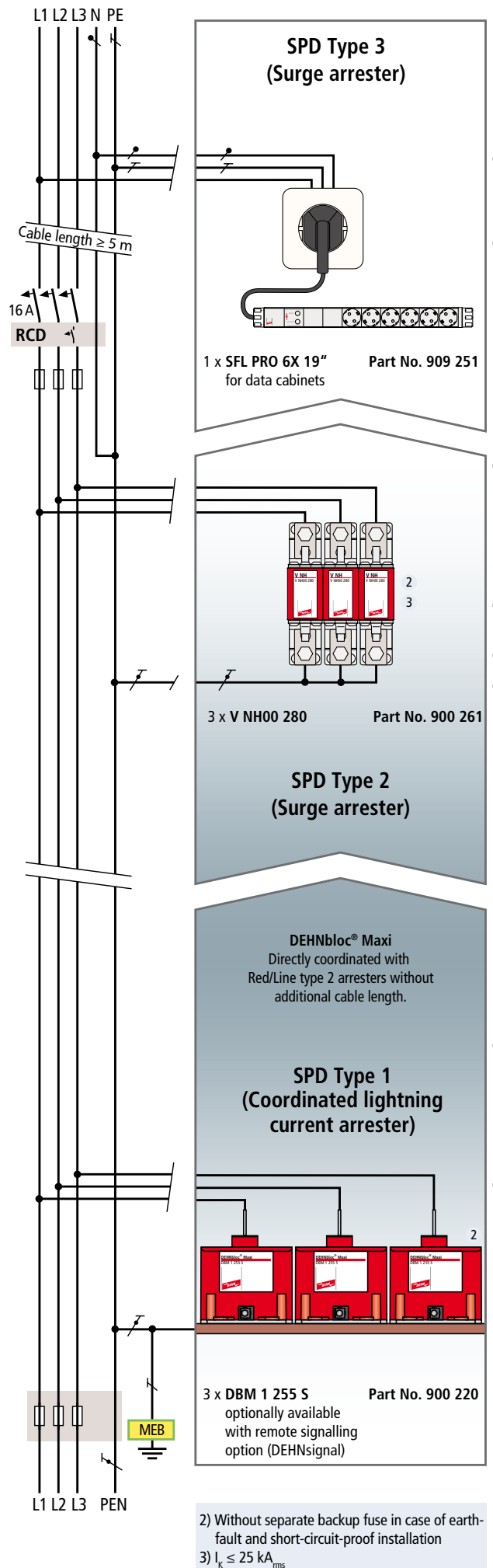

**Socket Outlet**

**Sub-distribution Board**

**Main Distribution Board**

- 2) Without separate backup fuse in case of earth-fault and short-circuit-proof installation
- 3)  $I_k \leq 25$  kA<sub>rms</sub>

## Roof-mounted Photovoltaic Systems Place of installation of the surge protective devices

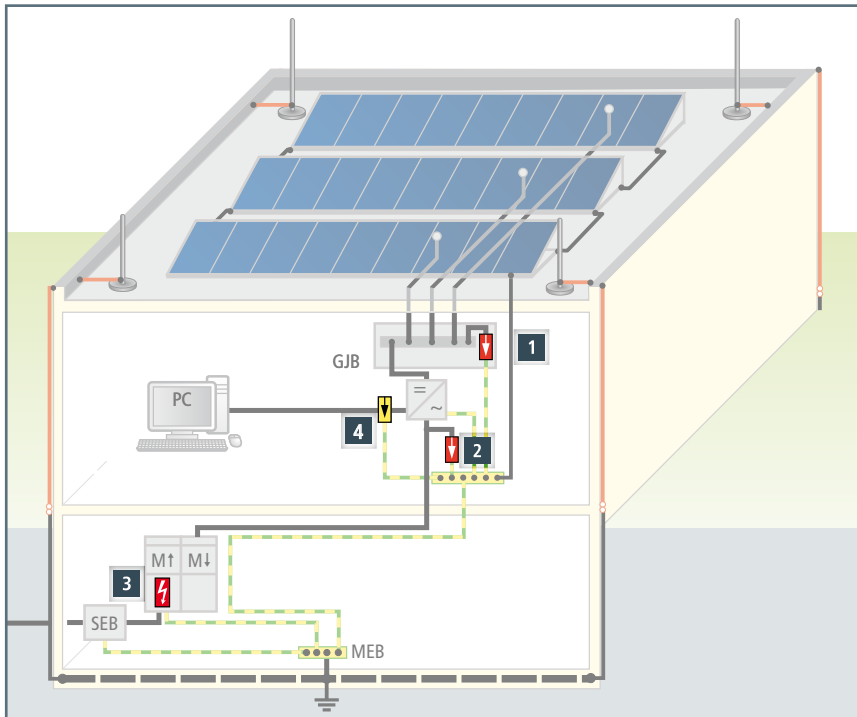

**a) Building without external lightning protection**

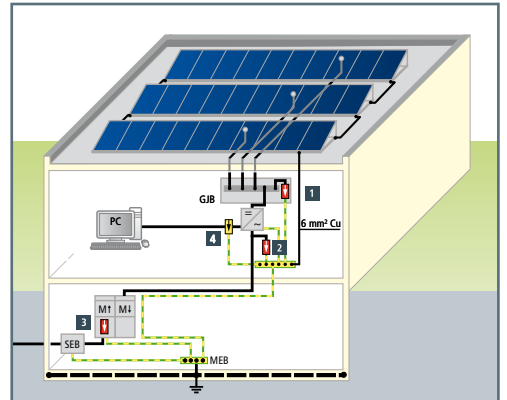

**b) Building with external lightning protection and sufficient separation distance**

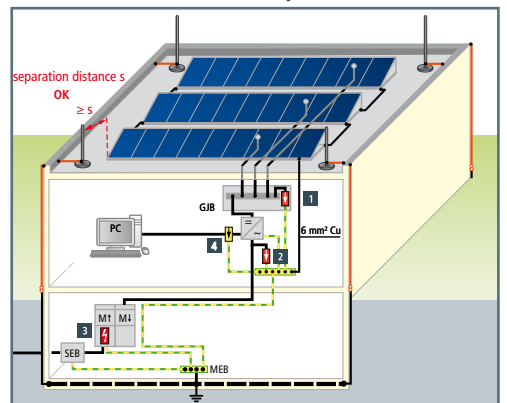

**c) Building with external lightning protection and insufficient separation distance**

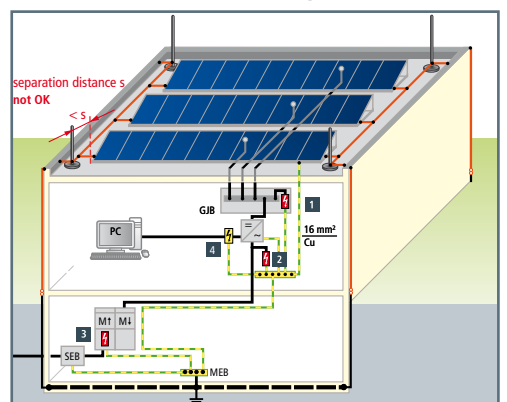

### Equipotential bonding

For lightning and surge protection reasons, it is strongly recommended to connect the PV frame as follows to the equipotential bonding system:

- Defined connection with at least 6 mm<sup>2</sup> copper at the PV frame (**a + b**).
- Defined connection with at least 16 mm<sup>2</sup> copper at the PV frame (**c**).
- Electrically conductive connection of the PV frames has to be ensured.
- The earth conductor is connected to the main earthing busbar of the building on ground level.
- The earth conductor has to be installed in parallel and in close proximity to the d.c. and a.c. cables / lines and accessory.

## 1 d.c. side

### Type 2 arrester DEHNgard® M YPV SCI

Multipole, modular surge arrester for PV systems: The patented SCI technology prevents fire damage caused by d.c. switching arcs

Type	Part No.
DG M YPV SCI 600 FM*	952 516
DG M YPV SCI 1000 FM*	952 515
DG M YPV SCI 1200 FM*	952 517
DG ME YPV SCI 1500 FM*	952 525



## 2 a.c. side (inverter)

### Type 2 arrester DEHNgard® M ... 275 FM

Multipole, modular surge arrester: High reliability due to "Thermo Dynamic Control" monitoring device

Type	Part No.
DG M TNC 275 FM*	952 305
DG M TNS 275 FM*	952 405
DG M TT 275 FM*	952 315



## 3 a.c. side (power supply)

### Type 2 arrester DEHNgard® M ... CI 275 FM

Multipole, modular surge arrester with integrated backup fuse: High reliability due to "Thermo Dynamic Control" monitoring device

Type	Part No.
DG M TNC CI 275 FM*	952 309
DG M TNS CI 275 FM*	952 406
DG M TT CI 275 FM*	952 327



### Type 1 combined lightning current and surge arrester DEHNventil® M ... 255 FM

Multipole spark-gap-based combined lightning current and surge arrester capable of carrying lightning currents with wave breaker function. Capable of protecting terminal equipment.

Type	Part No.
DV M TNC 255 FM*	951 305
DV M TNS 255 FM*	951 405
DV M TT 255 FM*	951 315



### Type 1 combined arrester DEHNventil® ZP

Lightning current carrying spark-gap-based combined arrester with wave breaker function. Easy installation on 40 mm busbar systems. Capable of protecting terminal equipment.

Type	Part No.
DV ZP TNC 255	900 390
DV ZP TT 255	900 391



### Type 1 combined lightning current and surge arrester DEHNlimit PV 1000 V2 FM

Multipole spark-gap-based combined lightning current and surge arrester for PV generator circuits with wave breaker function

Type	Part No.
DLM PV 1000 V2 FM*	900 345



### Type 1 application-optimised combined lightning current and surge arrester DEHNshield® ... 255

Multipole spark-gap-based combined lightning current and surge arrester with impulse current parameters which are sufficient for this place of installation

Type	Part No.
DSH TNC 255	941 300
DSH TNS 255	941 400
DSH TT 255	941 310



## 4 Data interface



### BLITZDUCTOR® XTU

DIN rail mounted combined lightning current and surge arrester with actiVsense and Life-Check technology for protecting two pairs of balanced interfaces (for example RS485) (BXT BAS base part required, Part No. 920 300)

Type	Part No.
BXTU ML4 BD 0-180	920 349

\*FM = floating remote signalling contact



Our promise

## DEHN protects

Our key objective is to protect material assets and workers. It was our pioneering spirit and innovative ideas that have defined our company for more than 100 years and made us a market leader with more than 1,500 employees. Our products and developments reflect our market feasibility, commitment and ideas.

As early as in 1923 our founder Hans Dehn started production of external lightning protection and earthing components to optimise the protection of buildings and installations. In 1954, we launched the first series of surge protective devices. Constant further development of these devices ensures safe operation and permanent availability of electrical and electronic installations. Also in the 1950s, our third sector, safety equipment, was added to our portfolio. The Bavarian town of Neumarkt is the heart of our activities where product managers and developers advance our protection technologies. Here we manufacture our high-quality safety products.



## We offer the best solution

Our concern is to be a reliable and fair partner for our industrial, commercial and technical customers all over the world. To this end, we always focus on the best solution to protection problems. Our sales teams in Germany and our global network of 11 subsidiaries as well as more than 70 international sales partners are committed to competent and customer-oriented distribution of our products.

Proximity and close contact with our customers is of utmost importance to us, be it on-site support by our experienced field staff team, our telephone hotline or personal contact at trade fairs.

In hundreds of seminars, workshops and conferences held every year throughout the world we impart practical knowledge on products and solutions. Our specialised book "Lightning Protection Guide" and our brochures will broaden your practical knowledge. Or visit us at [www.dehn.de](http://www.dehn.de) for information around the clock.

**Surge Protection  
Lightning Protection  
Safety Equipment  
DEHN protects.**

DEHN + SÖHNE  
GmbH + Co.KG.

Hans-Dehn-Str. 1  
Postfach 1640  
92306 Neumarkt  
Germany

Tel. +49 9181 906-0  
Fax +49 9181 906-1100  
info@dehn.de  
www.dehn.de

BLITZDUCTOR, DEHN, DEHN logo, DEHNBloc, DEHNguard, DEHNshield, DEHNventil, HVI, Red/Line, Yellow/Line are protected by German Trade Mark, Community Trade Mark (EU), and/or other countries.  
We accept no liability for technical modifications, misprints and errors. Illustrations are not binding.