

www.banhay.com; info@banhay.com; Hotline 24/7: 0986 219 626 - 0903 070 686

Lắp đặt Guardian Cat I, lắp đặt kim thu sét Guardian Cat II, lắp đặt kim thu sét Guardian Cat III,  
Install Guardian Cat I, Install lắp đặt kim thu sét Guardian Cat II, Install lắp đặt kim thu sét Guardian Cat  
III, Guardian Cat II, Guardian Cat III, Guardian Cat I, LPI Guardian Cat II, LPI Guardian Cat III, LPI  
Guardian Cat I

# ***Guardian System 5***

## **Installation Manual**



**LIGHTNING PROTECTION INTERNATIONAL PTY LTD**

ABN 11 099 190 897

Web: [www.lpi.com.au](http://www.lpi.com.au)

Email: [info@lpi.com.au](mailto:info@lpi.com.au)



## **GUARDIAN SYSTEM 5 INSTALLATION MANUAL**

As a result of continuing research and product development in the area of lightning and lightning protection, LPI reserves the right to alter any detail contained within at any time without notice.

Prior to installation of the Guardian System 5, installers should check with LPI or an authorised distributor to confirm they have the most recent version of the Guardian System 5 Installation manual.

It should be noted that 100% (100 percent) protection level for direct lightning strikes is not possible and cannot be provided due to the lightning discharge process being a natural atmospheric event.

### **Guardian System 5 Lightning Protection System**

System Owner: \_\_\_\_\_

Date Installed: \_\_\_\_\_

Installation Contractor: \_\_\_\_\_

Supplied by: \_\_\_\_\_

Location of Installation: \_\_\_\_\_



### **Lightning Protection International Pty Ltd**

ABN 11 099 190 897

Complex #1, 16 Mertonvale Circuit, Kingston,  
Tasmania, Australia, 7050

Phone: +61 3 62271955

Fax: +61 3 62291900

Email: [info@lpi.com.au](mailto:info@lpi.com.au)

Web: [www.lpi.com.au](http://www.lpi.com.au)

# ***Guardian System 5 Installation Manual***



**LIGHTNING PROTECTION INTERNATIONAL PTY LTD**

ABN 11 099 190 897

Web: [www.lpi.com.au](http://www.lpi.com.au)

Email: [info@lpi.com.au](mailto:info@lpi.com.au)

---

# Contents

Warranty	3	Fixing the HVSC Downconductor	20
Lightning Protection	3	Installation of Conventional Downconductors	20
<b>Quick Installation Guide</b>	<b>4</b>	Installation of Guardian CAT Terminal to threaded pipe	21
Recommended Order of Installation	4	<b>Termination of the HVSC Lower End</b>	23
Step 1. Installation of the Lightning Earth	4	Lower Termination of Conventional Downconductor to the Lightning Earth	26
Step 2. Installation of the HVSC Downconductor	5	<b>Termination of the HVSC Upper End</b>	26
Step 3. Lower Termination of the HVSC Downconductor and connection to the Lightning Earth	5	Connection of Factory Pre-Terminated HVSC (Upper End) to Guardian CAT Terminal	30
Step 4. Upper Termination of the HVSC Downconductor and connection to the Guardian CAT terminal	6	Labelling	30
Step 5. Preparation and Raising of the Mast into position	6	<b>Masts</b>	<b>31</b>
Checking Lightning Protection Components Supplied	13	Types of Mast Configurations	31
<b>LPI Guardian System 5 Installation</b>	<b>13</b>	Mast Bases	32
Installation of the Lightning Earth	14	Mast Couplings and Guying Points	33
Ground Resistance Lowering Compounds	15	Guying	33
Bonding the Lightning Earth	15	Preparation and Raising of the Mast into position	34
Labelling	16	Raising of Mast	35
Installation of the HVSC Downconductor	16	Lightning Strike Recorder (LSR1)	37
Hauling the HVSC Downconductor	16	Certification	38
HVSC Downconductor Clearance Holes	18	Operation and Maintenance	38
Routing	18	Testing the Guardian CAT Terminal	39
		Testing the Lightning Earth and the HVSC Downconductor	39

---

## **Warranty**

LPI's Guardian System 5 Lightning Protection System is guaranteed against defects in materials and workmanship for a period of 5 years from the original sales date when it was purchased from LPI or one of its authorised distributors.

The warranty is limited to the ex factory cost of replacement of equipment providing it has been installed and or certified by LPI or its distributor. All other costs such as freight, re-installation, loss of profit, insurance premiums are not included.

Responsibility for other direct or indirect damages or death is also specifically excluded from the warranty.

The range of Guardian CAT terminals (or to our knowledge any other lightning protection system) cannot provide 100% protection and therefore it is not inferred.

As confirmation of the above paragraph we refer to Australian Standard AS 1768 (2003).

---

## **Lightning Protection**

Comments on the Australian Standard AS 1768 (2003).

We refer to the standard where it states that it provides authoritative guidance of a general nature only and it is not intended to become a mandatory set of regulations.

As lightning develops in different ways due to different atmospheric processes, perfect lightning protection is virtually impossible to provide. Practical lightning protection should be provided taking particular note of statistical considerations.

Since the atmospheric lightning protection discharge is a natural process subject to statistical laws of nature with respect to ground density, peak current, mechanism, wave shape, topography and polarity, no warranty (direct or implied) is (or can be) made that 100% protection is offered or delivered. Whatever statistical level of protection chosen or recommended, the purchaser acknowledges that lightning may miss or bypass direct strike air terminals or systems. In addition the company accepts no responsibility for rare or abnormal events.

Users are warned that direct strike lightning protection is only one aspect of the overall protection strategy required for comprehensive structural, personnel and equipment safety. Correctly designed and installed low impedance earthing, elimination of earth loops, systems engineering, surge protection on power lines and transient protection of communications, data and telephone lines are also essential.

The LPI Guardian CAT Terminal should only be installed during storm free periods.

Figure 1.

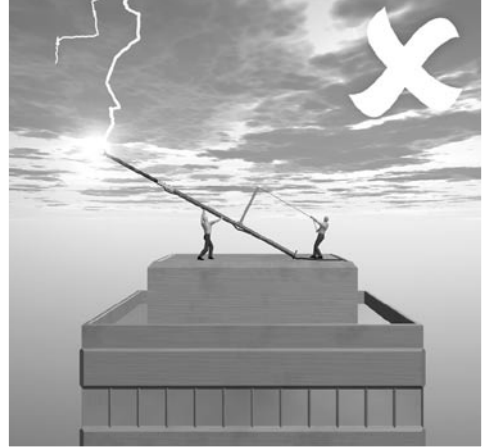
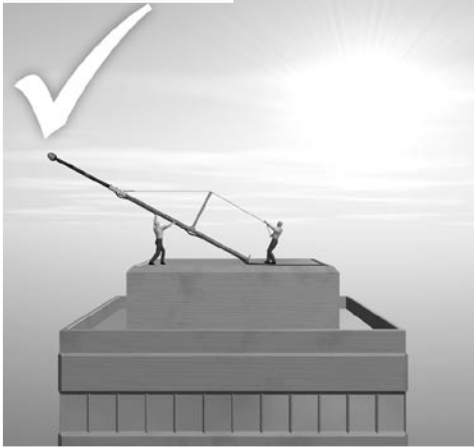

## Quick Installation Guide

### **Recommended Order of Installation**

To assist in the installation of the LPI Guardian System 5 refer to drawings CA-1, CM-1, CT-1, CW-1, CT-2, HVC-1 as illustrated on pages 7-12.

1. Installation of the lightning earth.
2. Installation of the HVSC Downconductor.
3. Lower termination of the HVSC Downconductor and connection to the lightning earth.
4. Upper termination of the HVSC Downconductor and connection to the Guardian CAT terminal.
5. Preparation and raising of the mast into position.

### **Step 1. Installation of the Lightning Earth**

LPI recommends the installation of a radial lightning earth as illustrated in figure 8 on page 14.

- Each radial will consist of a trench (Approx: 500mm Deep x 200mm Wide x 10m Length).
- An earth rod should be driven at the end of each trench.

- All rods should be interconnected through the use of 25mm x 3mm copper tape and earth rod clamps.
- The application of earth enhancing compounds such as LPI RESLO and GRIP assists to reduce soil resistivity to the recommended level of less than 10 ohms.

Refer to page 14 for more detailed information on installation of the lightning earth.

---

## **Step 2. Installation of the HVSC Downconductor**

- It is very important to check that the correct length of HVSC has been supplied.
  - The HVSC may be installed internally or externally on the structure.
  - The HVSC should be installed as close (flush) as possible to the structure.
  - The HVSC should be fixed to the structure every 2m for the entire length of the run. (Use LPI supplied or recommended saddles, fixings and cable ties).
  - Most direct route to ground is recommended, avoid sharp bends.
  - Be sure to allow for enough HVSC at the top end for connection to the Guardian CAT terminal and the raising of the mast. Refer to drawing HVC-1 on page 12 when installing HVSC over the edge of a structure.
- ➔ Refer to page 16 for more detailed information on the installation of the HVSC.
- ➔ If installing conventional downconductor such as copper tape or stranded copper cable refer to page 20 for further instructions.
- ➔ If installing Guardian CAT-GI model for connection to 2 inch male threaded pipe refer to drawing CT-2 on page 11. Further instructions are also given on page 21.

---

## **Step 3. Lower Termination of the HVSC Downconductor and connection to the Lightning Earth**

- When installing the HVSC downconductor a lower termination kit (Model Number: LTERMKIT) should have been supplied as part of the system.
  - Refer to page 23 for detailed instructions on completion of the HVSC lower termination and connection to the lightning earth.
- ➔ If installing a conventional downconductor such as copper tape or stranded copper cable refer to page 26 for instructions on connection to the lightning earth.

---

#### **Step 4. Upper Termination of the HVSC Down-conductor and connection to the Guardian CAT terminal**

- When installing the HVSC downconductor the upper termination may have already been completed at the LPI factory prior to shipment. If so refer to page 30 for further instructions.
- If the HVSC is supplied without the upper termination completed, an upper termination kit (Model Number: UTERMKIT) should have been supplied as part of the system. Refer to page 26 for detailed instructions on completion of the HVSC upper termination and connection to the Guardian CAT terminal.
- ➔ If installing a conventional downconductor such as copper tape or cable refer to page 20 for detailed instructions on connection to the Guardian CAT terminal.

---

#### **Step 5. Preparation and Raising of the Mast into position**

- With the upper termination of the HVSC completed and the FRP mast in position it is now time to finalise the mounting arrangement so that the mast can be raised and secured into position.
- If using the recommended installation methods as per drawings CA-1, CM-1, CT-1 & CW-1 fit the inline coupling to the lower mast material.
- Fit the HVSC downconductor in and out of the slot in the coupling. Refer to figure 34 on page 36.
- Carefully fit the mast butt adaptor of the Guardian CAT terminal into the top of the FRP.
- It may be necessary to pull back any slack of HVSC downconductor through the FRP support mast to achieve a tight fit for the mast butt adaptor. This should be completed carefully so as to not damage the upper termination.
- Now fix the FRP support mast firmly into the inline coupling and tighten the coupling so that the FRP mast and lower mast material are secured tightly into position.
- If a guy kit is to be installed the guys should be securely fixed to the eyelets as provided on the inline coupling. See figure 34 page 36.
- Refer to page 35 for instructions on how to safely raise the mast.
- ➔ Refer to page 31 onwards for more detailed information on preparation and raising of the mast.



**GUARDIAN CAT TERMINALS**

ORDERING CODE: CAT I-G  
APPROX WEIGHT 1.5kg  
106mm DIAM.

ORDERING CODE: CAT II-G  
APPROX WEIGHT 2.5kg  
150mm DIAM.

ORDERING CODE: CAT III-G  
APPROX WEIGHT 3.5kg  
212mm DIAM.

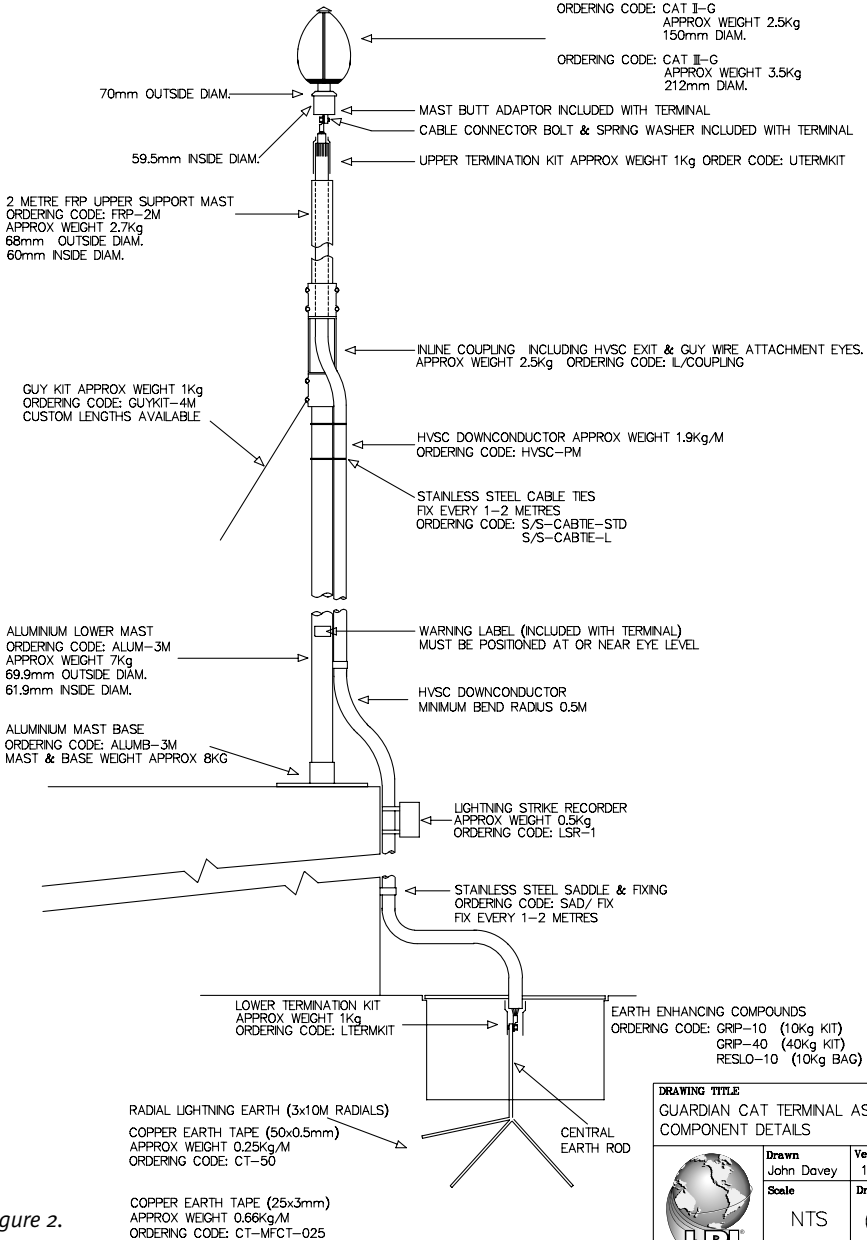

**DRAWING TITLE**  
GUARDIAN CAT TERMINAL ASSEMBLY  
COMPONENT DETAILS



Drawn John Davey	Version 1.00
Scale NTS	Drawing No CA-1

Figure 2.

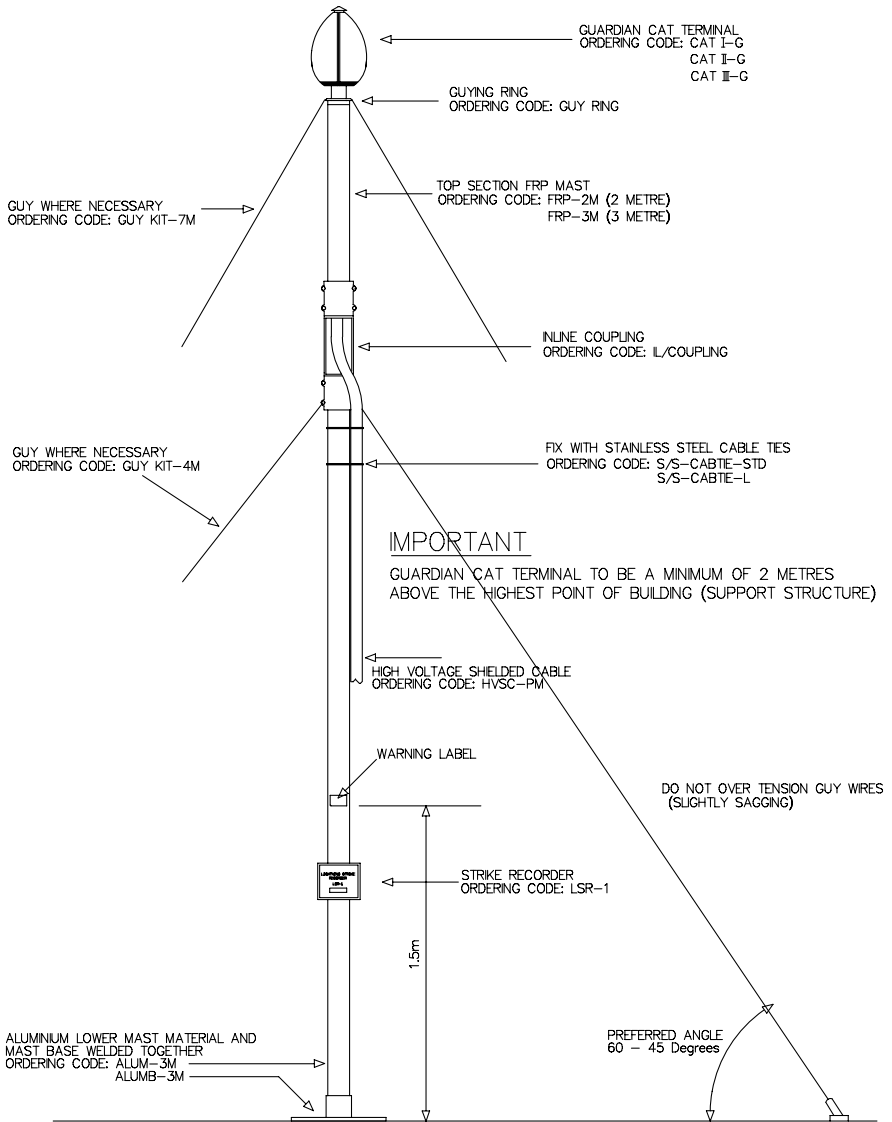

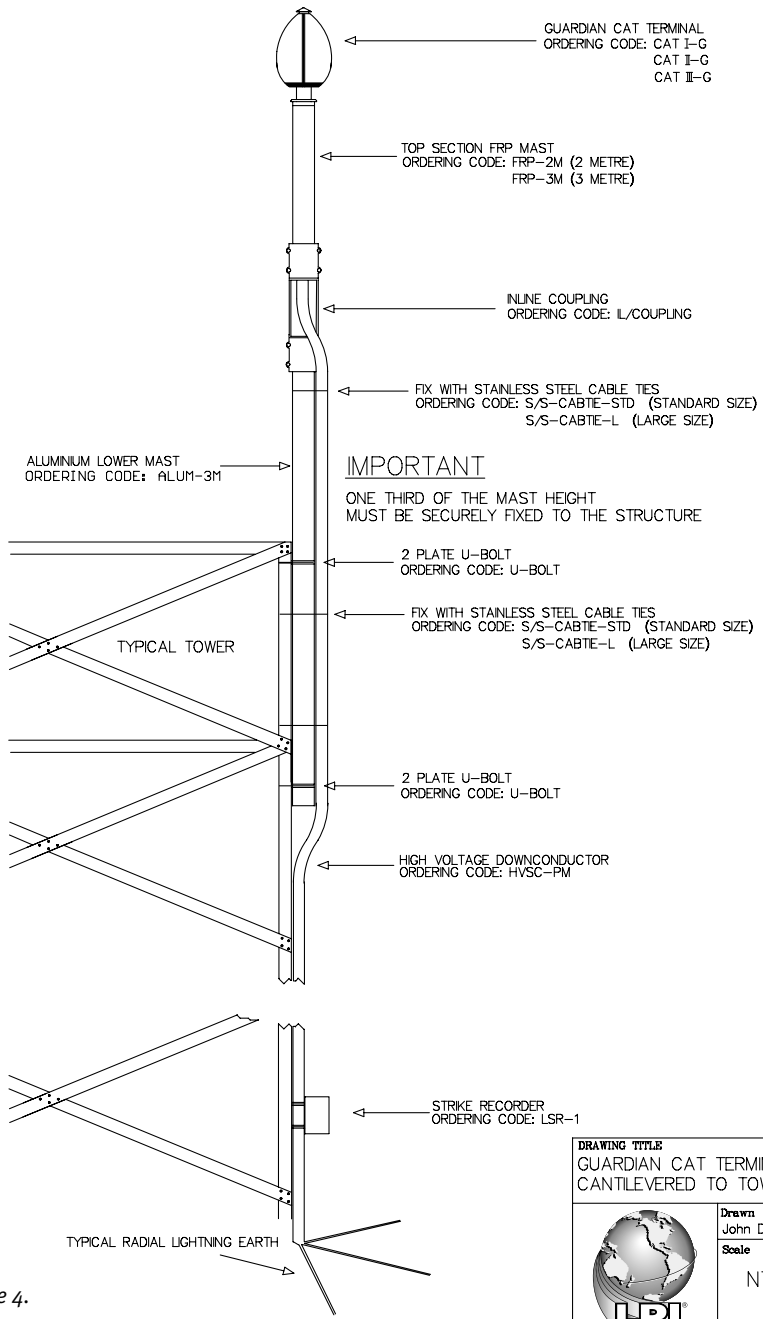

Figure 3.

DRAWING TITLE		
GUARDIAN CAT TERMINAL MOUNTING MAST GUYED		
	Drawn John Davey	Version 1.00
	Scale NTS	Drawing No CM-1



<b>DRAWING TITLE</b> GUARDIAN CAT TERMINAL MOUNTING CANTILEVERED TO TOWER		
	Drawn John Davey	Version 1.00
	Scale NTS	Drawing No CT-1

Figure 4.



**IMPORTANT**

ONE THIRD OF THE MAST HEIGHT  
MUST BE SECURELY FIXED TO THE STRUCTURE

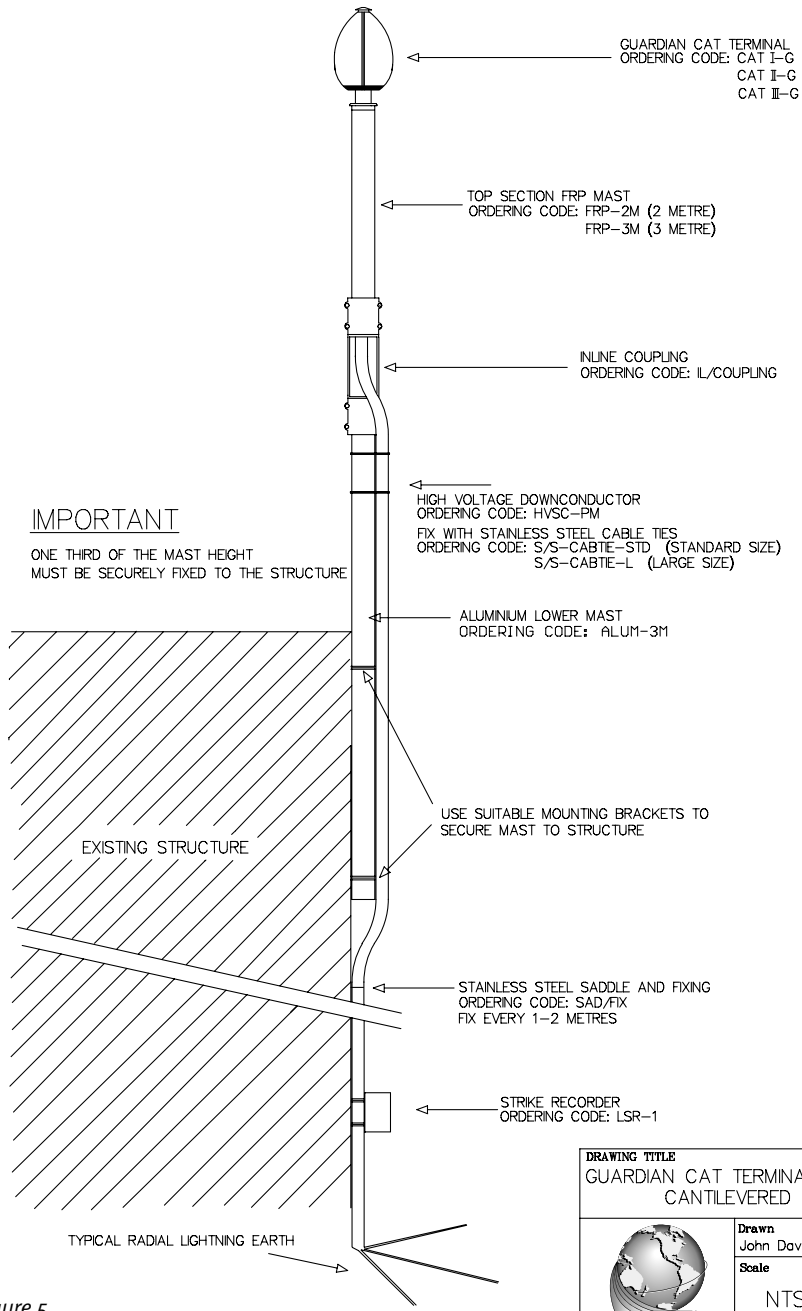
**DRAWING TITLE**  
GUARDIAN CAT TERMINAL MOUNTING  
CANTILEVERED TO WALL

	<b>Drawn</b> John Davey	<b>Version</b> 1.00
	<b>Scale</b> NTS	<b>Drawing No</b> CW-1

Figure 5.

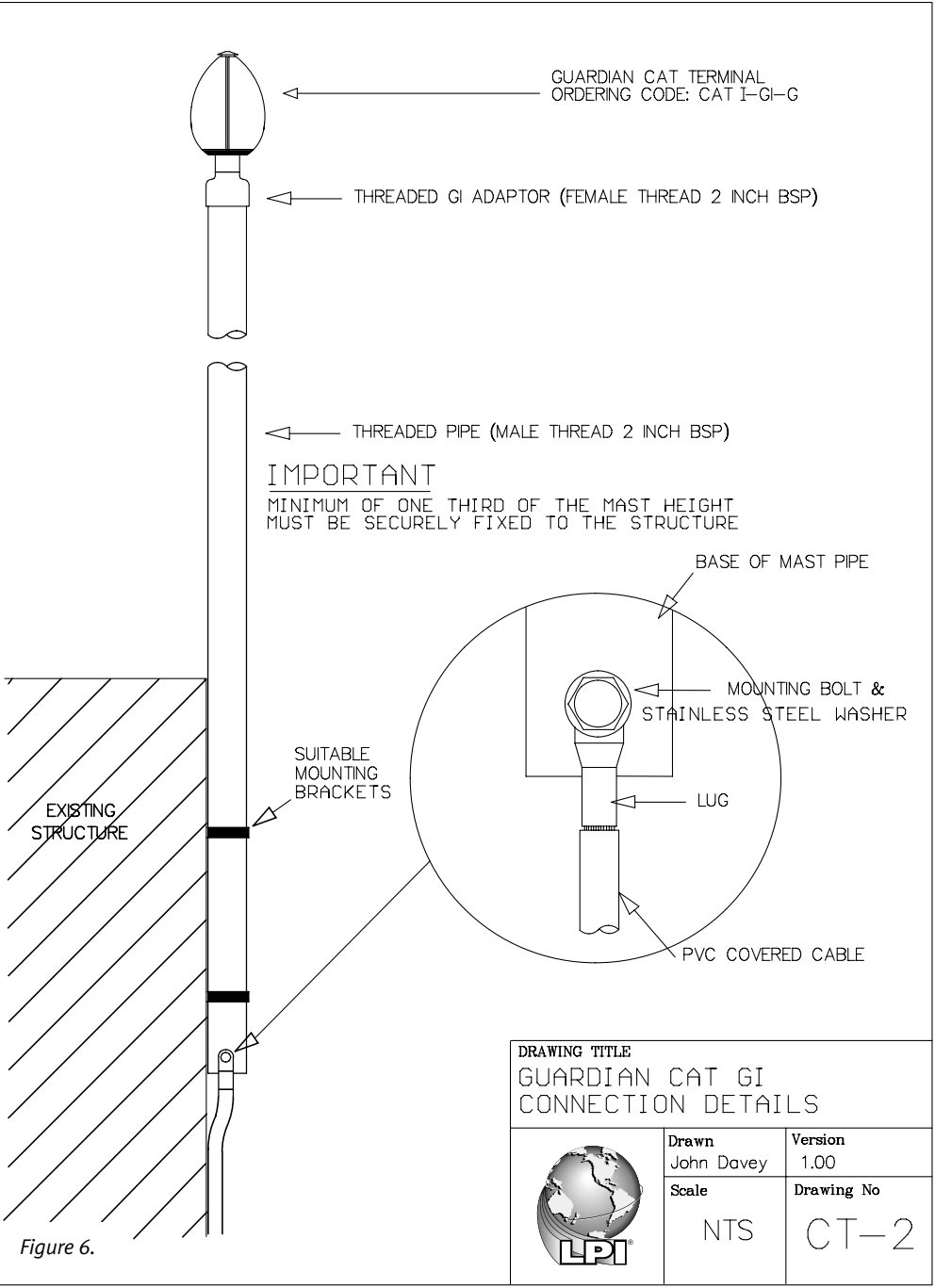



Figure 6.

DRAWING TITLE		
GUARDIAN CAT GI CONNECTION DETAILS		
	Drawn John Davey	Version 1.00
	Scale NTS	Drawing No CT-2

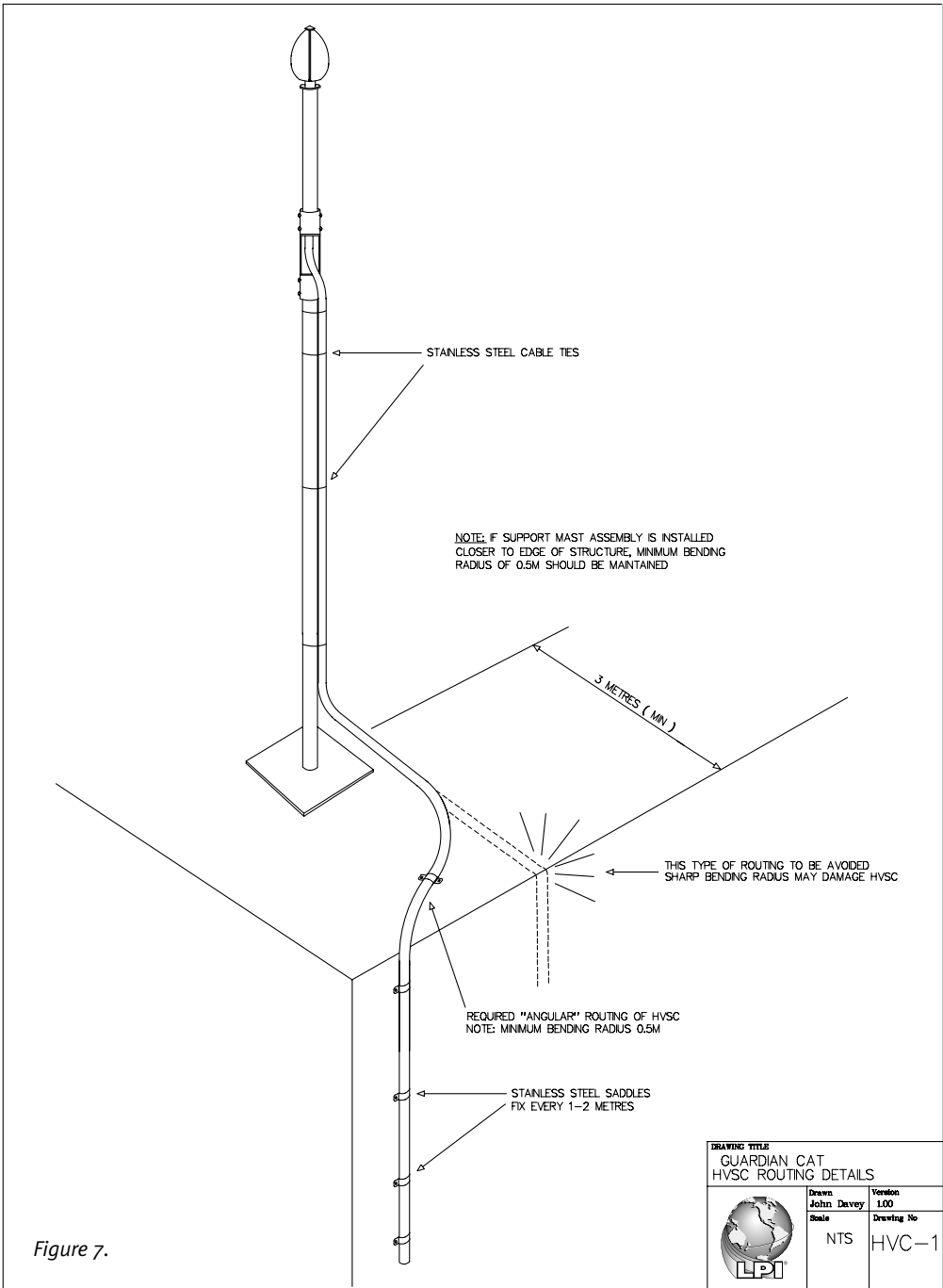

Figure 7.

DRAWING TITLE		
GUARDIAN CAT HVSC ROUTING DETAILS		
Drawn	Version	
John Davy	100	
Scale	Drawing No	
NTS	HVC-1	



---

## **Checking Lightning Protection Components Supplied**

The Guardian System 5 components received should be checked against the “Bill of materials” for loss during shipping and for damage.

Check the following:

### **Terminal (s)**

- Terminals have not been dented or damaged in any way during transit.

### **Downconductor(s)**

- The HVSC cable drum (if supplied) is not damaged.
- The correct HVSC length(s) have been supplied.
- No obvious damage to the HVSC cable.
- If a factory completed upper termination is supplied check to see that the termination is not damaged.

Lengths and quantities of HVSC (if multiple lengths on one drum), will be shown on the side of the Cable Drum(s).

## **LPI GUARDIAN System 5 Installation**

All site and safety requirements must be followed during the installation of the LPI Guardian System 5.

The correct order of installation is as follows:

1. Installation of the lightning earth.
2. Installation of the HVSC downconductor.
3. Lower termination of the HVSC downconductor and connection to the lightning earth.
4. Upper termination the HVSC downconductor and connection to the Guardian CAT terminal.
5. Preparation and raising of the mast into position.

LPI Guardian System 5 should only be installed during storm-free periods.

If the Guardian CAT terminal needs to be raised prior to connection to the lightning earth or immediate connection is not possible then connect the lower end of the downconductor to structural steel reinforcing or other suitable earth point.

## Installation of the Lightning Earth

Before installation of the lightning protection earth consult site drawings of underground services so that these are not damaged during installation of the earthing system.

Earth DC resistance (typically <10 ohms) and impedance (typically <30 ohms) is required for successful operation of LPI Guardian System 5.

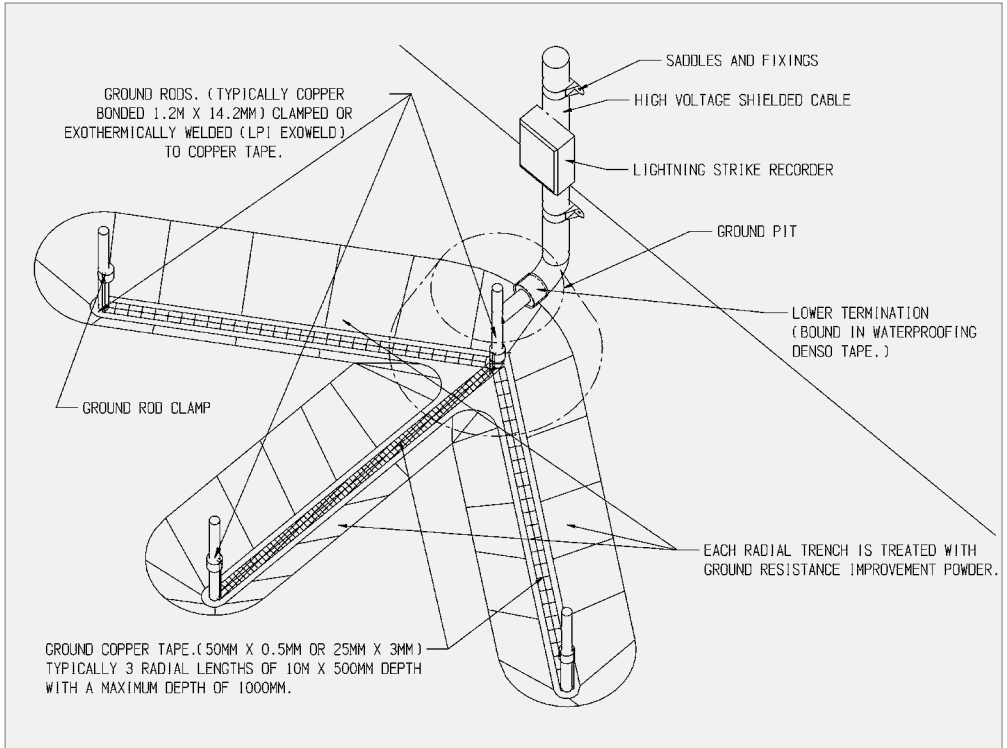

Figure 8.

LPI recommends the installation of a radial lightning earth as shown in figure 8.

- Recommended to install a 3 length radial trench.
- Each radial will consist of a trench (Approx: 500mm Deep x 200mm wide x 10m length).
- An earth rod should be driven at the end of each trench.
- All rods should be interconnected through the use of 25mm x 3mm copper tape. The use of earth rod clamps to fix the tape to rods is recommended.



- The application of earth enhancing compounds such as LPI RESLO and GRIP assists to reduce soil resistivity to the recommended level of less than 10 ohms.
- A ground pit should be installed where the end of the down-conductor terminates to the lightning earth as shown in figure 8. This gives an access point for disconnection and future testing.
- Do not lower terminate (connect) the downconductor to the earthing system at this point in time.

Note: If due to space constraints it is not possible to install a radial earth as recommended consult with LPI or an authorised distributor for further advice.

When using earth rods:

- Use driving heads to prevent mushrooming on top of rod.
- Use driving heads when using coupled rods.
- Use a post or picket driver.

Methods for bonding the earthing system components are listed below:

- The use of the EXOWELD exothermic welding process is a safe and efficient way of providing a permanent connection between conductors. EXOWELD connections will not corrode or rust with age.
- DO NOT use aluminium lugs or couplings

---

## **Ground Resistance Lowering Compounds**

- Ground resistance lowering compounds (such as LPI RESLO and GRIP) are supplied when the existing soil mass has a high resistivity.
- Using the compounds can lower earth resistance/impedance.
- Compounds will require water and a mixing container.
- Follow all installation and safety instructions as supplied with products when applying the compounds.

---

## **Bonding the Lightning Earth**

Where separate earths exist eg: Structure, Power, Communications and Lightning Protection, they need to be bonded to form an equipotential ground plane. This will stop ground loops and potential differences arising under transient conditions.

Before bonding of these earths takes place make sure proper authorisation is gained.

Bonding cable must be 70mm (2/oAWG) minimum depending on local standards. It may be necessary to use a Transient Earth Clamp (LPI TEC) which bonds all earths to the same potential under transient conditions.

For further information, it is advisable that local applicable standards are used, ie IEC 61024-1, BS 6551, AS1768-2003, NFPA 780. C22.1 -98 and NEC.

---

## **Labelling**

It is the responsibility of the customer/installer to label earth pits or earthing systems to local requirements.

---

## **Installation of the HVSC Down-conductor**

If installing LPI HVSC, the HVSC downconductors(s) may have had the upper terminations completed at a pre-specified end of the cable by the LPI factory before being shipped.

When removing HVSC downconductor packaging, do not use a knife or cut in any way as this can damage the outer layer of termination.

LPI's HVSC has an outer layer which is approximately 2mm (1/16in.) thick. Be careful not to damage this layer.

---

## **Hauling the HVSC Down-conductor**

Place the HVSC downconductor cable drum close to where it is to be installed.

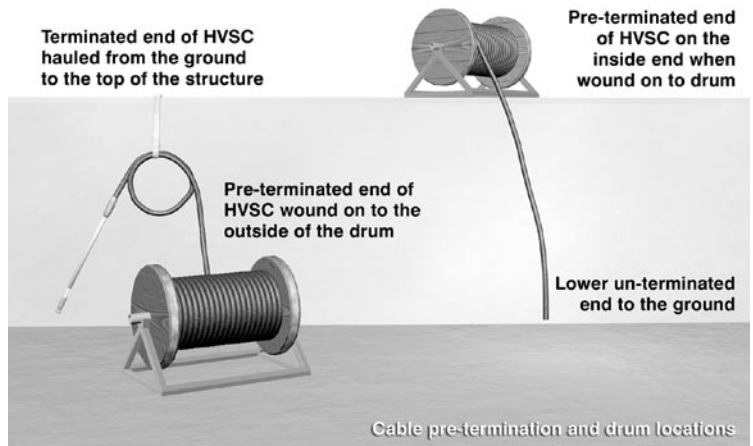

Figure 9.

- Make sure that the cable drum is in a good condition.
- Check that the correct length of HVSC downconductor has been supplied. The length of HVSC will be marked on the drum.
- If the HVSC downconductor has been upper terminated on the outside of the drum, then the HVSC downconductor will need to be hauled up the structure with the drum staying on the ground.
- If the HVSC downconductor has been upper terminated on the inside of the drum, then the drum has to be taken to the top or near the top of the structure, then the HVSC downconductor can be hauled downwards from the drum to the ground.
- Any lifting slings or ropes must be securely attached.
- DO NOT haul the HVSC downconductor from the termination lug, see Figure 10.
- Protect the HVSC downconductor at all times when it is being moved.

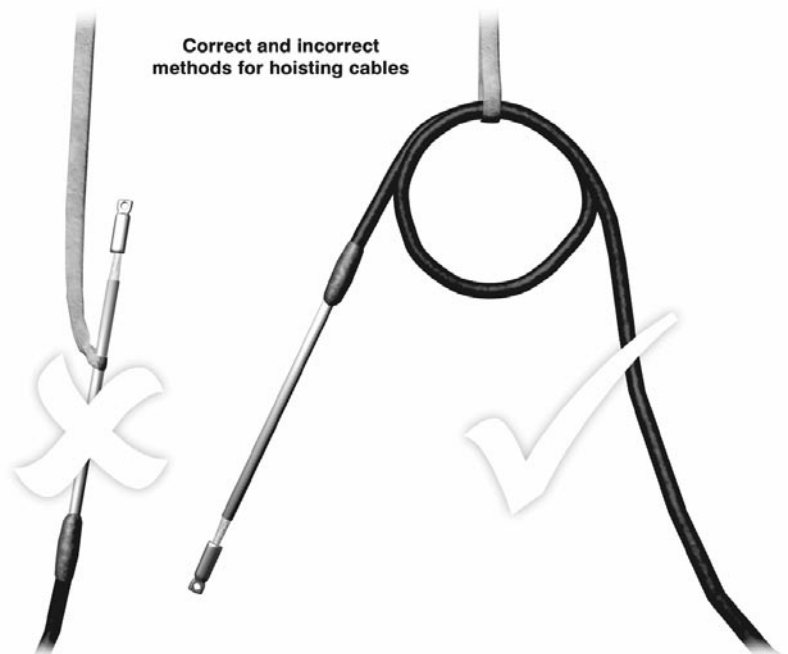

Figure 10.

---

## ***HVSC Down-conductor Clearance Holes***

Before running the HVSC downconductor through any clearance holes, ensure that:

- A minimum hole diameter of 60mm (2 $\frac{3}{8}$ in.) is used.
- Enough protection is provided so that the HVSC downconductor is not damaged.

A waterproofing sealant or sealing gland should be used if the hole needs to be weatherproof.

---

## ***Routing***

The routing of the HVSC downconductor needs to follow these guidelines:

The route of the HVSC downconductor should be as set out in the original design. Ensure no structural changes such as new antenna or mast installations, air conditioning towers or ducting has been installed.

- DO NOT double the HVSC downconductor back against itself after changes of direction, ie: 180°.
- The HVSC downconductor may be installed internally or externally on the structure.
- The HVSC downconductor should be installed as close (flush) as possible to the structure.
- Minimise the number of bends and use the most direct route to ground.
- Minimise strain on the HVSC downconductor.
- Ensure bend radius maintained >500mm (20in.).
- Parallel routing with other services – Minimum separation = 20cm. See Figure 11 on page 19.
- If the HVSC downconductor has to cross other services make sure it crosses at right angles using a conduit that extends at least 1m past either side of the existing service.
- The lower end of the HVSC downconductor must terminate close to the initial injection point of the lightning earth.
- Be sure to allow for enough slack in the HVSC at the top end for connection to the Guardian CAT Terminal and the raising of the mast.
- If it is necessary to isolate the HVSC downconductor from the structure put the cable in an insulating conduit with a minimum wall thickness of 3mm (1/8in.). The maximum length isolated from the

structure should be 2.5m (9ft). The entire length of the HVSC down-conductor cannot be run in insulated conduit.

- HVSC Downconductor should be protected from damage at the lower end by installing a sleeve of no more than 2m from ground level.

The HVSC downconductor must be checked by an LPI representative if it is damaged during installation to see if the damage will affect performance.

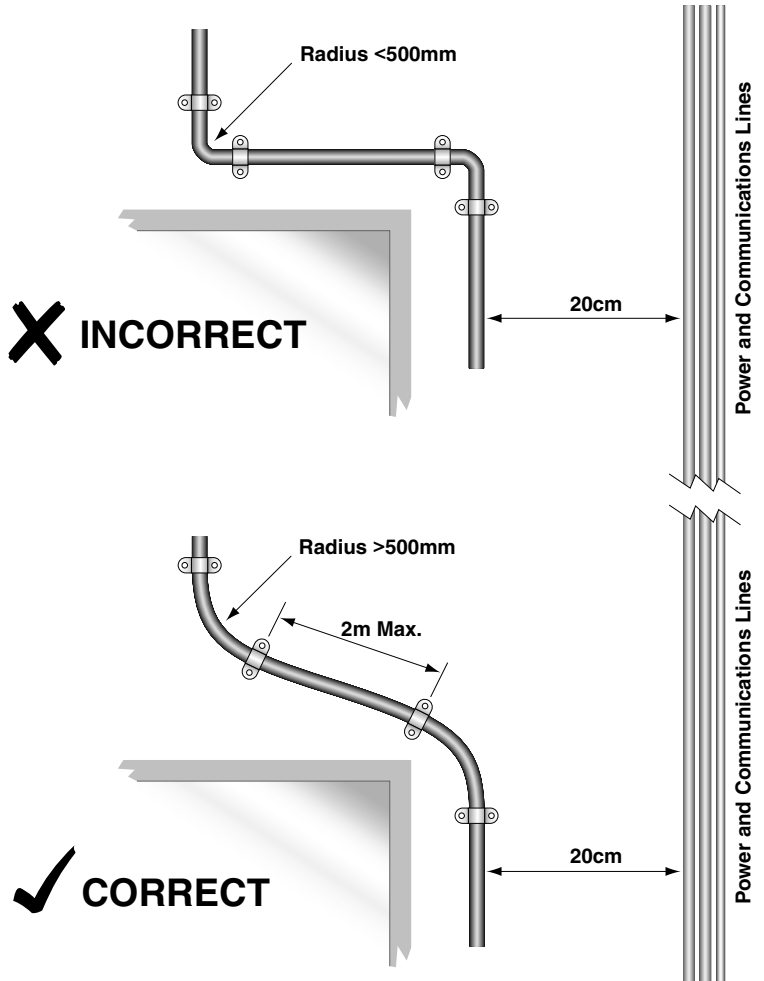

Figure 11.

## Fixing the HVSC Down-conductor

Using non LPI saddles can damage the downconductor outer sheath.

- The HVSC downconductor should be fixed to the structure every 2m for the entire length of the run.
- For masonry walls or roofs, use the LPI saddles provided. These can be used with masonry anchors, suitable fastenings for wood, fibreglass and metallic surfaces or self tapper screws.
- Use cable ties when fixing to pipes, tower legs, masts, etc.
- If the HVSC downconductor is to be routed above a false ceiling, ensure that it is fixed to the underside of the concrete floor slab.
- Do not use explosive fastening methods on LPI saddles or HVSC downconductors.

## Installation of Conventional Down-conductors

In some installations the use of copper tape or insulated stranded copper cable may be installed as the downconductor. In such cases it may be necessary to install multiple downconductors in compliance with local standards. (NFC 17-102, AS1768-2003, BS6651). See the following dot points for further information.

The Guardian CAT Terminal provides a bolt for the lug connection to the lower finial connector of the mast butt adaptor. All conventional downconductors should be lugged and fixed to the terminal as per figure 12 below.

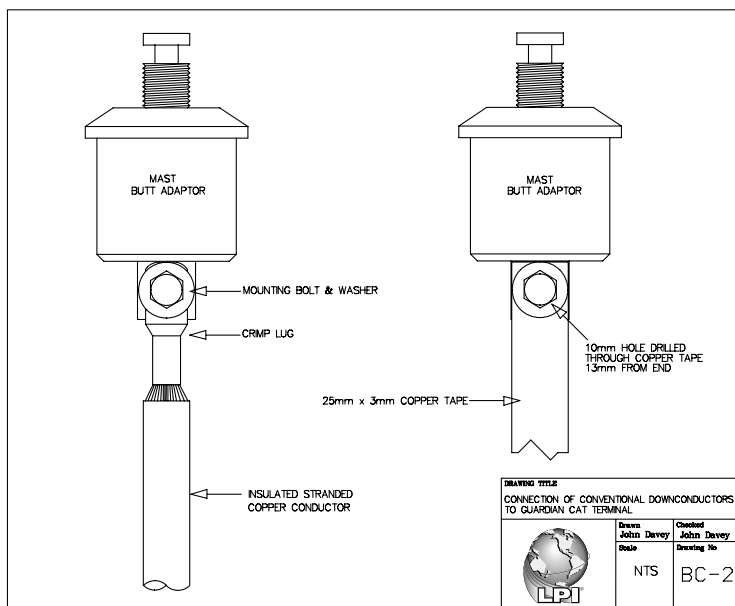

Figure 12.

The following are recommendations and points that should be considered when installing conventional downconductors.

- Downconductors should be installed at each external corner of the building and additional downconductors installed at spacing not exceeding 20m.
- The most direct path to ground is recommended avoiding sharp bends.
- Downconductors should be installed around the outside walls of the structure. It is not recommended to install downconductors internally to the structure.
- It is not recommended to locate downconductors in areas where personnel are liable to congregate.
- Any extended metal running vertically through the structure should be bonded to the lightning downconductor at the top and bottom of the structure.
- Each downconductor should be connected to the earthing system.
- Where practical all structural steel and metallic reinforcement in the structure should be bonded to the downconductor system.
- The use of copper conductors are recommended and should have a cross sectional area of not less than 35mm<sup>2</sup>.
- Recommended copper conductor size is 25mm x 3mm.
- The copper should be of a grade normally used for commercial electrical work.
- The use of PVC insulated copper, bare aluminium and stainless steel can be used as downconductors.
- Suitable fasteners should be installed to adequately secure all downconductors.
- Downconductors should be fastened at spacings not exceeding 1.0m on horizontal runs and not exceeding 1.5m on vertical runs.

---

### ***Installation of Guardian CAT GI Terminal to threaded pipe***

LPI offers within its range of Guardian CAT terminals a GI version which is designed for a threaded connection to a 2 inch GI pipe. Please refer to drawing CT-2 on page 11 and figure 13 for further details.

The Guardian CAT GI terminal is supplied with a threaded coupler (female thread) fixed to the terminal and designed for connection to a 2 inch pipe (Male thread).

Figure 13.

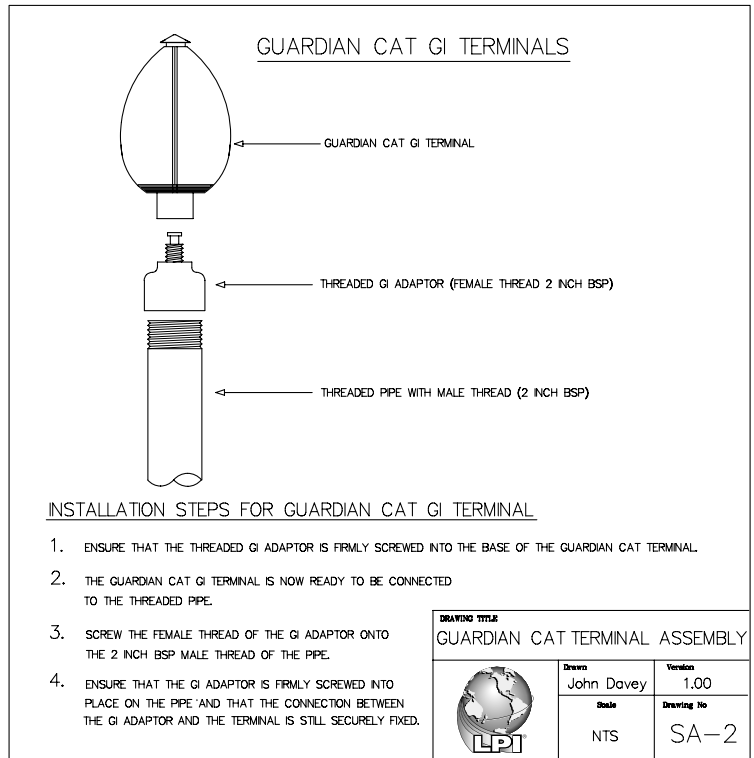

Figure 14.





- Following installation of the Guardian CAT GI terminal to the threaded pipe as per drawing CT-2 and figure 13 it will be necessary to connect the metallic pipe to a conventional downconductor in order to convey the lightning energy to the earthing system.
- Ideally the connection between the metallic pipe and the conventional downconductor should be completed by lugging or exothermically welding (LPI EXOWELD) the downconductor at a practical point somewhere along the length of the pipe.
- Particular care should be taken to ensure that compatible metals are used when connecting the downconductor to the metallic pipe.
- For installation details of the conventional downconductor please review instructions and comments as detailed under the heading Installation of Conventional Downconductors on page 20.

## ***Termination of the HVSC Lower End***

Tools required for the completion of the HVSC Lower Termination include:

- Compression or Mechanical Crimping Tool
- Sharp Knife
- Insulation Friction Cutting Tool
- Shifting Spanner
- Rubber Gloves

### **Lower Termination Kit Consists of**

- 1 x Roll Denso Tape
- 1 x 95mm Crimp Lug
- 2 x Warning Stickers
- 1 x Earth Clamp
- 1 x Insulation Friction Cutting Tool

The following steps outline the termination of the lower end of the High Voltage Shielded Cable to the lightning earth.

The inner screen copper conductors and the outer screen copper conductors should be connected to the earthing system.

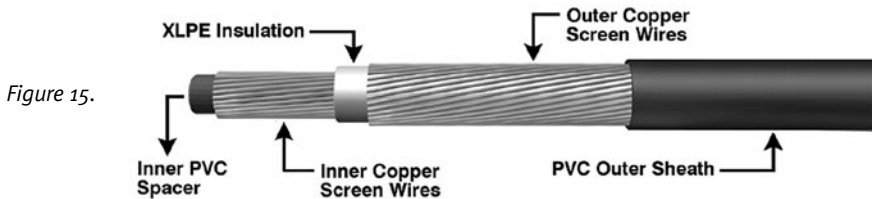

1. Remove the outer sheath for a length of 15cm from the lower end of the HVSC by cutting radially around HVSC cable with the supplied insulation friction cutting tool. (This is less likely to damage individual copper conductors than by cutting radially with a knife). The lengthwise cut can be completed with a knife.
2. Remove the binder tape (2<sup>nd</sup> layer) for a length of 15cm from the end of the HVSC, this will expose the outer screen copper conductors as shown in Figure 16.

**Remove the outer sheath and binder tape for a length of 15cm from the end of the HVSC, this will expose the outer screen copper conductors**

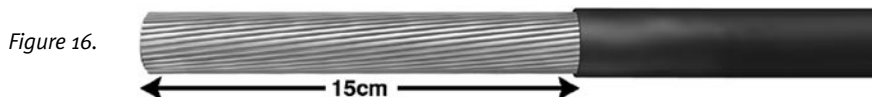

3. Fold outer screen conductors back without damaging them. For a length of 5cm from the end of the HVSC remove XLPE insulation (4<sup>th</sup> layer) and inner binding tape (5<sup>th</sup> layer) to expose inner screen copper conductors. Be sure not to remove outer screen conductors in this step. It is recommended to use the insulation friction cutting tool in this step.
4. Fold inner screen conductors back without damaging them. For a length of 5cm from the end of the HVSC remove the inner PVC spacer under the inner screen copper conductor leaving the inner screen copper conductor in place.

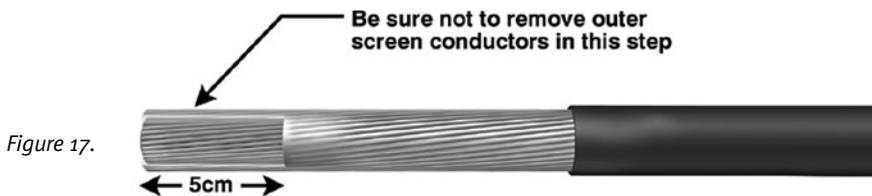

**Remove XLPE insulation and inner binding tape to expose inner screen copper conductors**

5. Bunch together both inner and outer screen conductors. If connecting directly to the earth system as per figure 20 then the bunched conductors should be connected to the earth rod clamp and the clamp tightened holding the conductors firmly in place. To avoid oxidation of this connection seal it using the water resistant (Denso Tape) as provided in the kit.

**Bunch together both inner and outer screen conductors, crimp them together in the crimp lug provided using a compression or mechanical crimping tool**

Figure 18.

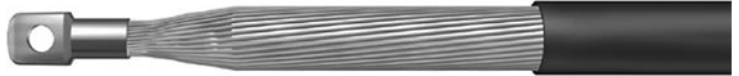

6. If terminating the lower end of the HVSC to a bus bar then bunch together both inner and outer screen conductors, crimp them together in the crimp lug provided using a compression or mechanical crimping tool and connect the bus bar as per Figure 19.

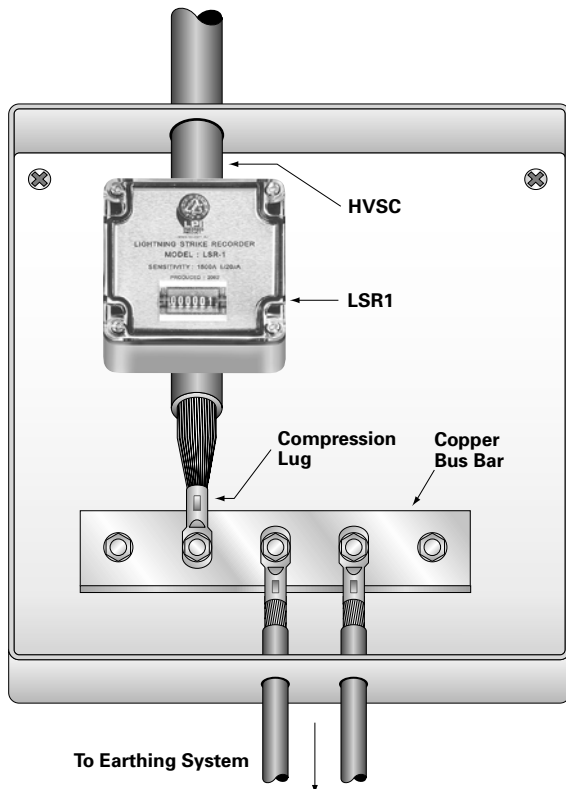

Figure 19.

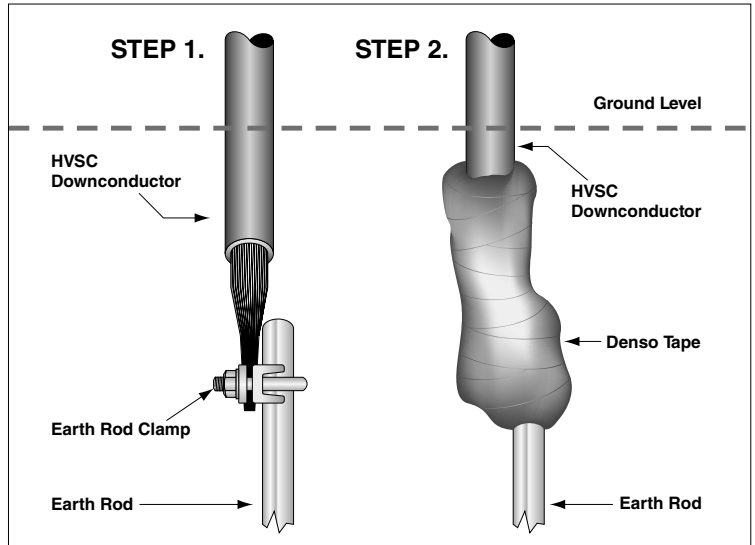

Figure 20

## **Lower Termination of Conventional Down-conductor to the Lightning Earth**

If a conventional downconductor such as copper tape or stranded copper cable has been installed as the downconductor then the lower end of the conductor should be directly connected to the lightning earth and sealed with a water resistant Denso tape so as to avoid oxidation.

- If installing stranded copper cable as a downconductor then the lower end should be connected to the lightning earth through the use of an earth rod clamp and then wrapped with water resistant Denso tape to avoid oxidation.
- If installing a copper tape (25mm x 3mm) as a downconductor then the lower end should be directly connected to the lightning earth through the use of a suitable earth rod clamp and then wrapped with water resistant Denso tape to avoid oxidation.

## **Termination of the HVSC Upper End**

Tools Required for the completion of the HVSC Upper Termination Include:

- Compression or Mechanical Crimping Tool
- Sharp Knife
- Insulation Friction Cutting Tool
- Shifting Spanner
- Rubber Gloves

## Upper Termination Kit Consists of:

- 1 x 2.25m/19mm Semi Conductive Tape
- 1 x 50mm Crimp Lug
- 1 x 0.5m /38mm Mastic Tape
- 1 x 15cm Cold Shrink
- 1 x Insulation Friction Cutting Tool

The following steps outline the terminating of the upper end of the High Voltage Shielded Cable.

1. In preparation for the upper termination of the HVSC it is important to feed the HVSC cable through the FRP Support mast prior to starting the upper termination. Refer to figure 21.

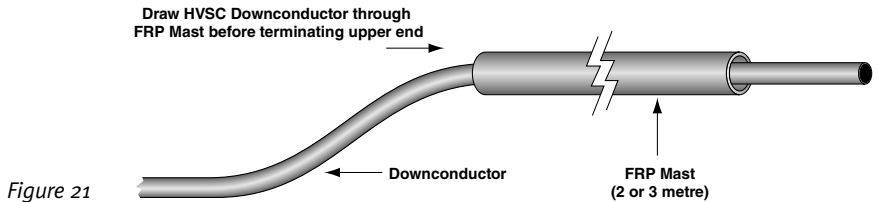

2. Firstly remove the outer sheath material for a length of 1.2 metres by cutting radially around HVSC cable with the supplied insulation friction cutting tool. (This is less likely to damage individual copper conductors than by cutting radially with a knife). The lengthwise cut can be completed with a knife.
3. Cut and remove the outer screen copper conductors 3 cm above the end of the outer sheath.

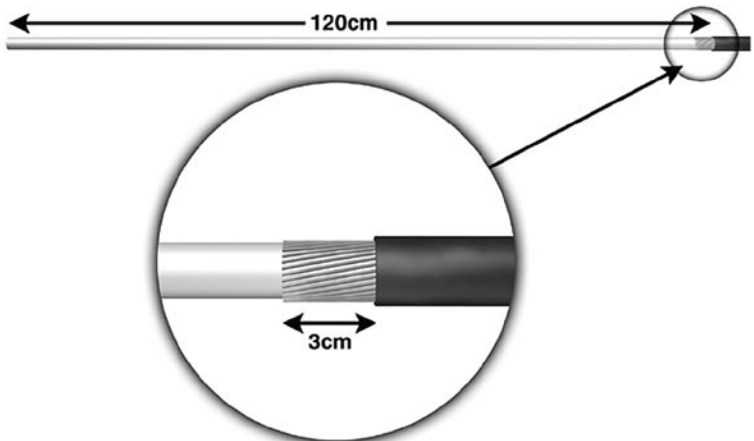

4. Fold the outer screen copper conductors back over the outer sheath, secure the outer screen conductors in place by wrapping 50cm of the HV insulation tape provided (5cm covering XLPE insulation, 5cm covering folded screen over the outer sheath).

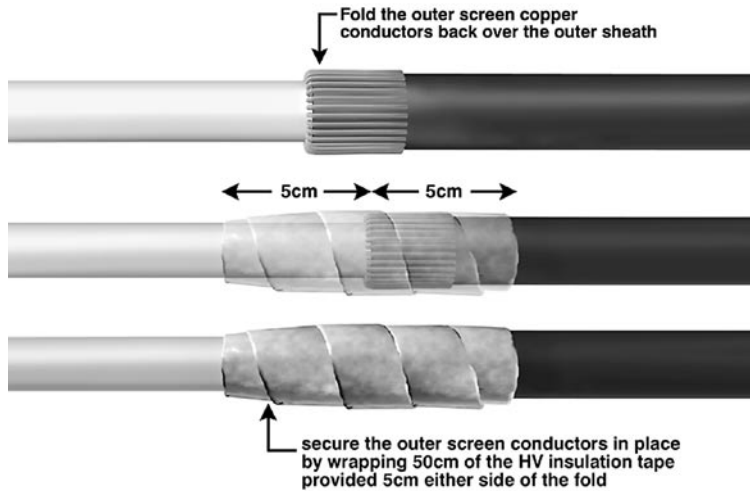

Figure 23.

5. Remove XLPE insulation (4th layer) and inner binding tape (5th layer) to expose inner screen copper conductors for a length of 5cm from the top end of the HVSC. It is recommended to use the insulation friction cutting tool in this step.
6. Fold back inner screen copper conductors and for a length of 5cm from the end of the HVSC, remove the inner PVC spacer under the inner screen copper conductors and return these conductors to their original position.
7. Crimp the inner screen copper conductors in the crimp lug provided using a compression or mechanical crimping tool.

Figure 24.



8. Slide cold shrink onto the cable in preparation for later step (ensure release strap is coming out from inside white tube at the lower end i.e. The other end from the crimp lug so the cold shrink contracts from top to bottom but with the strap being pulled out from the inside of the bottom of the cold shrink).

**Note: The cold shrink should be placed into position in this step, however it should not be applied until step 11.**

9. The lugged HVSC is now ready to be connected to the base of the Guardian CAT terminal. Take the mast butt adaptor as supplied in the Guardian CAT box and screw the mast butt adaptor firmly into the base of the CAT terminal. Connect the crimp lug to the CAT terminal mast butt adaptor using the nut and bolt as supplied with the mast butt adaptor. Ensure the connection is tightly secured.

Figure 25.



10. Using the 19mm semi conductive tape (2.25m) apply the tape starting at the white XLPE material and continue to the mast butt adaptor. Build up as smooth a finish as possible from the insulation to the bottom of the mast butt adaptor.

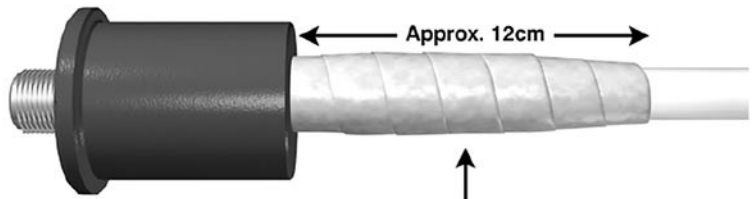

Using semi-conductive tape wrap from 5cm below where the white insulation finishes and the copper core starts up to the base of the mast butt adaptor ie. Covering the crimp lug and brass lower connector

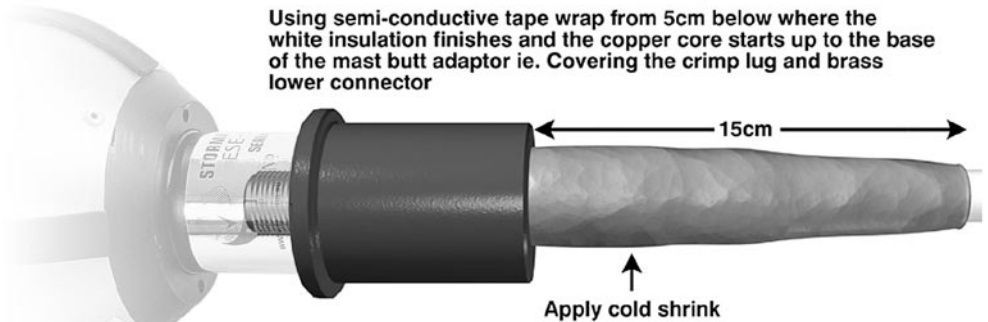

Figure 26.

11. Place the cold shrink up against the bottom of the mast butt adaptor, pull the release strap away from the mast butt adaptor (rotate around the cable as the release strap is pulled to ensure

semi conductive tape is not effected by cold shrink application process). When the cold shrink is applied it should be situated hard up against the mast butt adaptor and continue 15cm down the cable covering the entire semi conductive taped connection.

## **Connection of Factory Pre-Terminated HVSC (Upper End) to Guardian CAT Terminal**

Tools required for the installation of the factory completed upper termination include:

- Sharp Knife
  - Medium size Phillips head screw driver
1. Firstly remove the protective packaging from the cable and upper terminated end section taking care not to cut cable or associated upper termination parts in the process.
  2. Using Phillips head screwdriver remove screw holding mast butt adaptor to lower connector and retain both screw and mast butt adaptor.
  3. In preparation for completion of the installation of the factory completed upper termination it is important to feed the HVSC cable through the FRP support mast.
  4. Once the terminated HVSC has been carefully fed through the top end of the FRP mast, slide the black plastic mast butt adaptor back onto brass lower connector, line up holes and insert phillips head screw into position tightly. Now screw the mast butt adaptor into the Guardian CAT terminal.

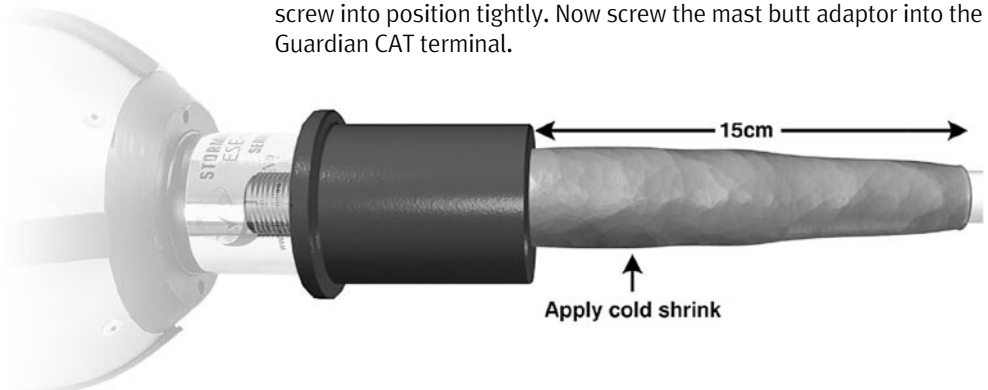

Figure 27.

## **Labelling**

Warning Labels are supplied with all Guardian CAT terminals and should be installed as per the following.

- In locations where personnel may be in close contact to the HVSC Downconductor.



- Where the HVSC downconductor connects to the earthing system.
- At the base of the support mast.

There are 2 Warning Label's supplied in the front cover of this manual and also 2 supplied in the lower termination kit. If more labels are required, contact your nearest LPI supplier or Distributor.

## Masts

The mast chosen for the application must:

- Raise the terminal to a height of at least 2 metres (6.5ft.) higher than the structure. (Minimum accepted).
- An (FRP) mast section of at least 2 metres (81 in.) must be used below the air terminal, if using LPI HVSC.
- Be suitable for local weather conditions. Seek guidance from a local civil engineer.
- Be guyed and securely attached to the dedicated mounting points if required.

### Types of Mast Configurations

When mounting a Guardian CAT terminal there are generally three types of mast configurations that can be used.

#### Cantilevered

Typically used for mounting to a tower or the side wall of a plant room when a mast and base are not suitable. See drawings CT-1, CW-1 and Figure 28 .

- $1/3$  of the overall mast height must be fixed to the structure for adequate mechanical strength.
- Cantilevered masts can be guyed for additional strength. If guying the use of a guy ring and or the eyelets provided on the inline coupling can be utilized.

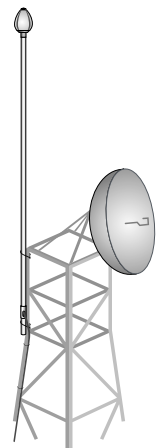

Figure 28.  
Cantilevered Mast

## Guyed

When mounting a Guardian CAT terminal a typical guyed configuration would involve the following. See drawing CM-1 and Figure 29.

- Two sections of mast (Aluminium mast & FRP mast) coupled together with a inline coupling. Securing of guy wires is completed at the eyelets as provided on the inline coupling.
- Alternatively a guy ring can be supplied which is installed at the neck of the mast in between the CAT terminal and the top section of the FRP. The guy ring provides eyelets for connection of the guy wires.

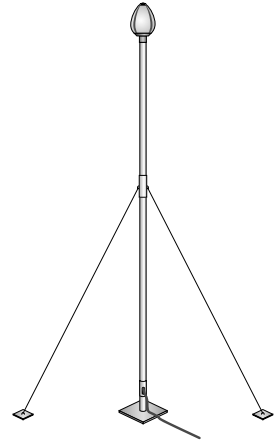

Figure 29. Guyed Mast

## Freestanding

A freestanding mast configuration is typically used in situations where protection by isolation is required. For example a Guardian CAT terminal is installed 5 metres or more away from a fuel storage tank.

Prior to installing the freestanding mast ensure that:

- A spigot has been supplied with the freestanding mast which allows for external or internal mounting of the FRP mast.
- The downconductor can exit through the base of the freestanding mast if run internally.
- Adequate information is provided for mast foundation requirements.

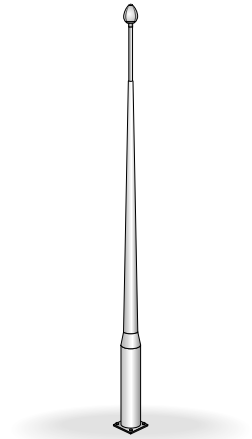

Figure 30. Freestanding Mast

---

## Mast Bases

LPI supplies a mast base welded directly onto the required length of aluminium mast. The base has a hole in the bottom for the downconductor to run if being routed inside the mast. Ordering Code: ALUMB-3M.

---

## **Mast Couplings and Guying Points**

There are two methods of coupling two sections of mast:

1. The U-Bolt set uses two stainless steel U-Bolts to clamp the two masts together.
2. The inline coupling fixes the upper and lower mast sections together and provides guying points and an exit point for the HVSC downconductor.

Figure 31.

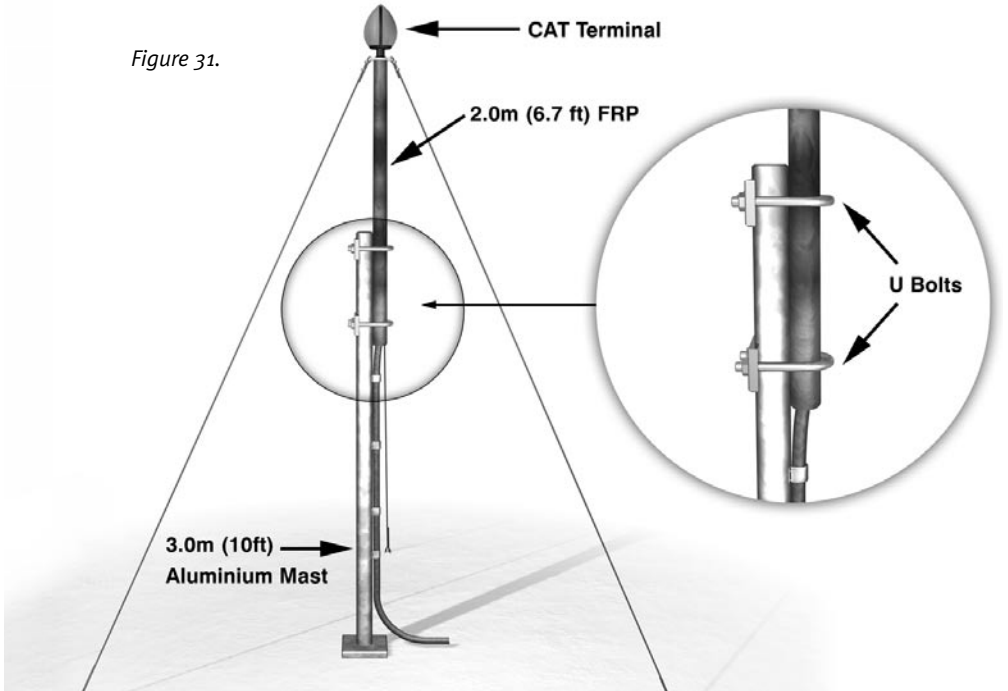

U-Bolts and Inline Couplings nuts must be tightened to no more than 55kg/cm (45in.lb).

A Guying Ring is supplied for guy points for any two piece masts that require double guying. This fits on the terminals mast butt adaptor between the Guardian CAT terminal and the top of the mast. See Figure 32 under the heading titled Guying.

---

## **Guying**

LPI offers a standard 4m (13 ft) guy kit made up of light weight plastic coated fibreglass non-conductive cable. If using conductive guy lines they must be connected at the lower anchor points to the downconductor by a conductor, or alternatively use appropriate guying insulators.

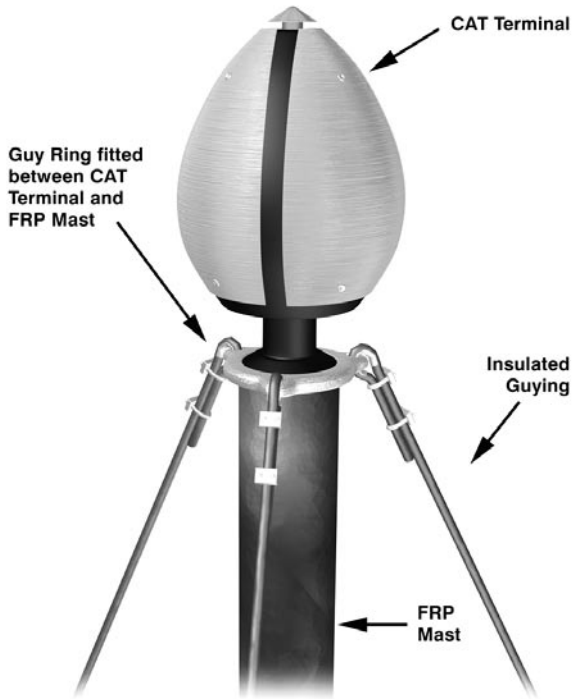

Figure 32.

#### Important Recommendations:

- The guying angle must be no greater than  $60^\circ$  from horizontal.
- The inline coupling couples the upper and lower mast sections and provides guying points and an exit point for the HVSC downconductor.
- Minimum of 3 guying grips per guy end.
- Guying grips spaced at a minimum of 30mm (1 in.).
- Grips are correctly orientated –saddle on the longer length side of the guy and U-bolt over the tail side of the guy.
- Tighten grips to no more than 60N.m (5lbf.in) of torque.
- Customised guy kits can be supplied upon request.

## **Preparation and Raising of the Mast into Position**

- With the upper termination of the HVSC completed and the FRP mast in position it is now time to finalise the mounting arrangement so that the mast can be raised and secured into position.
- If using the recommended installation methods as per drawings CA-1, CM-1, CT-1 & CW-1 fit the inline coupling to the lower mast material.

- Fit the HVSC downconductor in and out of the slot in the coupling. Refer to Figure 34 on page 36.
- Carefully fit the mast adaptor of the Guardian CAT terminal into the top of the FRP.
- It may be necessary to pull back any slack of HVSC downconductor through the FRP support mast to achieve a tight fit for the Guardian CAT terminal. This should be completed carefully so as to not damage the upper termination.
- Now fix the FRP support mast firmly into the inline coupling and tighten the coupling so that the FRP mast and lower mast material are secured tightly into position.
- If a guy kit is to be installed the guys should be securely fixed to the eyelets as provided on the inline coupling and or the guy ring. See text and graphics as detailed under the heading Guying for more information.

---

## ***Raising of Mast***

When raising the mast.

- Guys to inline coupling and or guy ring must be properly secured.
- Guys must not be twisted, kinked or damaged.
- Guys must be able to be easily secured at the base when the mast has been raised.

Turnbuckles or Rigging Screws are recommended at the base anchor points of the guys.

Other guying methods such as conductive stainless steel can be used only on aluminium masts or inline couplings below an FRP section.

Using a crane is recommended or other suitable equipment for anything over 6 metres (20ft.) in height, or for hazardous areas such as heights.

- It is very important to keep the mast straight during the lift to avoid damaging the mast.
- The Guardian CAT terminal must NOT be used as a slinging point.
- When lifting the mast, ensure that the slings or ropes cannot damage the Guardian CAT terminal, see Figure 33.
- When lifting the mast the HVSC downconductor must be tied off to the mast to remove any strain on the HVSC downconductors termination to the Guardian CAT terminal.

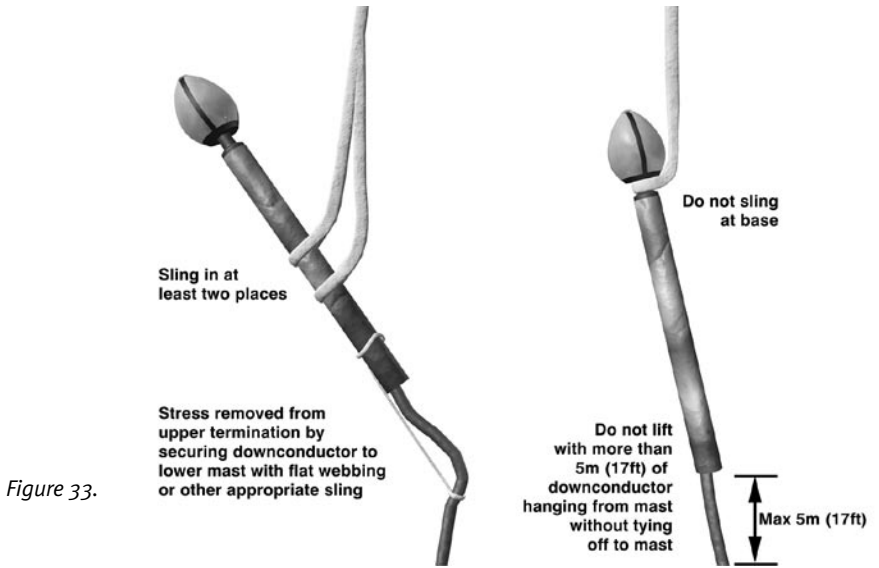

Figure 33.

- Protect the HVSC downconductor at the base of the mast when lifting, maintain a minimum bending radius of 500mm (20 in.) and ensure it does not drag over rough or sharp surfaces.

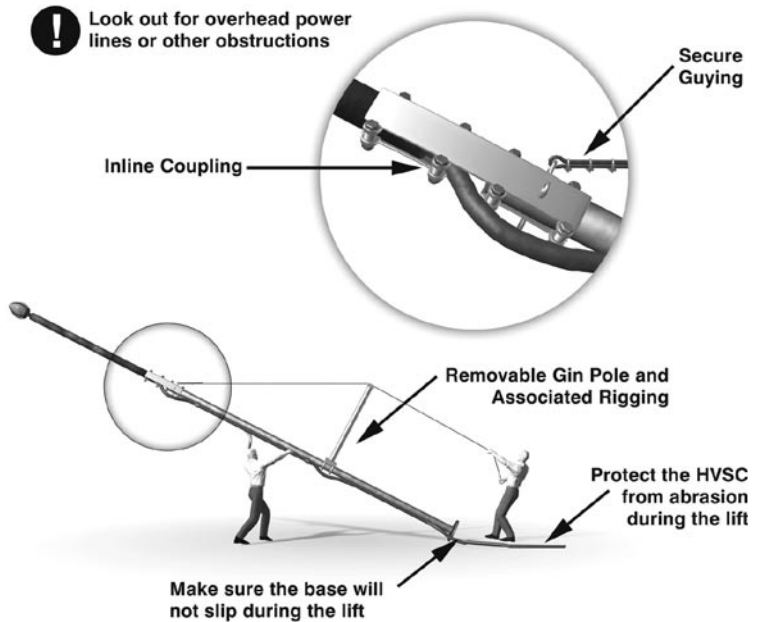

Figure 34.

# Lightning Strike Recorder (LSR1)

The Lightning Strike Recorder (LSR1) should be installed at a position along the downconductor length where it can be accessed easily for inspection. Typically the LSR1 should be installed approximately 1.5m from ground level or alternatively within the ground pit at the lower termination point of the HVSC.

When installing the LSR1 the following should be considered.

- The LSR1 should be mounted away from areas where damage may occur due to theft, vandalism or damage from nearby operations.
- The LSR1 can be enclosed in a security enclosure but the display should be kept visible to allow for the checking of recorded strikes.

Figure 35. Lightning Strike Recorder installed on HVSC Downconductor

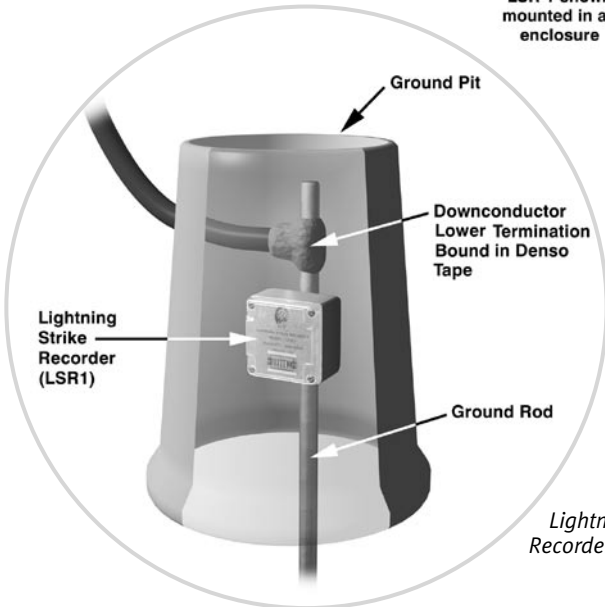
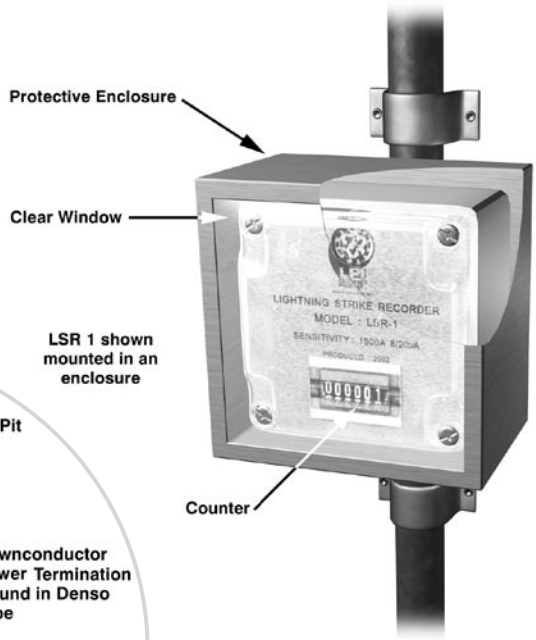

Figure 36. Lightning Strike Recorder installed on Rod.

---

## ***Certification***

The certification of the LPI Guardian System 5 installation should be performed by an authorised LPI representative.

A certificate of compliance and warranty registration is provided with the installation manual. This certificate should be completed in full following the successful inspection and certification of the installation.

The following should be checked for quality of workmanship and compliance to recommended installation instructions.

Certification checklist

- Correct mast and any associated brackets and fastenings have been used for installation.
- Guying, anchor points and fastenings.
- HVSC Downconductor routing, fixing and weatherproofing.
- Lower termination of HVSC Downconductor.
- Earthing System.
- Labelling.

---

## ***Operation and Maintenance***

The LPI Guardian System 5 Lightning Protection System is designed to react to the rise in electric field which is present in approaching thunder storms. The Guardian CAT Terminal becomes active only during storm activity.

- The system operates without the need for external power supply or spare parts for standard operation.
- To keep the LPI Guardian System 5 Lightning Protection System operating at optimum levels it needs to be regularly checked.

Maintenance checks must be done:

- After each known lightning strike to the terminal.
- Once every twelve months.
- If changes have been made to the structure.

Checks to be conducted in standard maintenance inspection:

- Is there any damage to Guardian System 5?
- Has the structure to be protected been modified since the last maintenance check?
- Check finial tip for excessive pitting.



- Check all rigging, mast mounts, saddles and conductor fixings are secure and tight.
- Ensure that no dirt or other matter is sitting in the air gap between the finial tip and the surrounding panel edges.
- If conventional downconductors are used, check that all conductors are securely fixed and not damaged.
- Check for damage to the LPI HVSC, the installed position of the downconductor should not be able to be accessed by non authorised people or machinery.
- All warning labels must still be in place.
- Check LSR1 for secure installation and record number of strikes.

---

## ***Testing the Guardian CAT Terminal***

### **Tools required to complete operational test of CAT terminal**

A Standard Insulation Tester such as a Megger will be required to complete testing of the Guardian CAT terminal. The insulation tester to be used must have a meg ohm scale that provides for a voltage of between 500V and 1500V to be applied.

### **Steps for testing CAT terminal**

1. The CAT terminal can be tested once installed or prior to mounting.
2. Ensure that the CAT terminal is dry prior to testing the terminal. If moisture is visible wipe dry with a clean cloth.
3. If the terminal is not yet installed and moisture is visible complete step 2. As an additional measure shake the CAT terminal gently to allow all moisture to escape through the drainage holes at the base of the terminal.
4. One lead of the tester is placed between the rivets on each panel, whilst the other lead is placed on the finial tip.
5. The same test should be applied for each of the four panels (4 tests in total).
6. The result for each panel should be greater than 2 mega ohms.
7. If one or more tests does not meet the 2 mega ohms requirements as detailed in step 6, the CAT terminal should be removed washed thoroughly with clean water removing all dirt and or debris.

Be sure to thoroughly dry the terminal as detailed in step 3 prior to re-testing. The terminal can be tested separate from the mast.

8. If the terminal still fails the test, please contact LPI or an authorised LPI agent for further instructions.

The LPI GUARDIAN System 5 lightning Protection System may not operate at full efficiency in all environmental conditions ie.under ice or snow or on chimneys or exhaust stacks releasing gasses or pollutants. For advice on dealing with these specific environments contact your local LPI Distributor

---

## ***Testing the Lightning Earth and the HVSC Down- conductor***

Use the table on page 41 to record the results following completion of the following steps.

1. Remove the waterproofing denso tape from the lower termination.
2. Disconnect the HVSC downconductor from the lightning earth.
3. Disconnect the structure earth bonding cable from the earth system.
4. Measure the earth resistance of the lightning earth system and record in column 1 under the heading Earth Resistance Readings in the table provided on page 41.
5. Measure the earth resistance of the structure and record in column 2.
6. Reconnect the structure earth bonding cable to the lightning earth and measure and record in column 3 the earth resistance reading.
7. Use a multimeter to measure the continuity between the inner and outer conductors of the HVSC downconductor. The measurement should exceed 10,000 ohms.
8. Reconnect the HVSC lower termination to the lightning earth and re-seal the termination using denso tape to ensure that it is waterproof.
9. Reconnect the structure earth bonding cable to the lightning earth.
10. Report any problems arising from the above tests to your local LPI distributor for further advice.

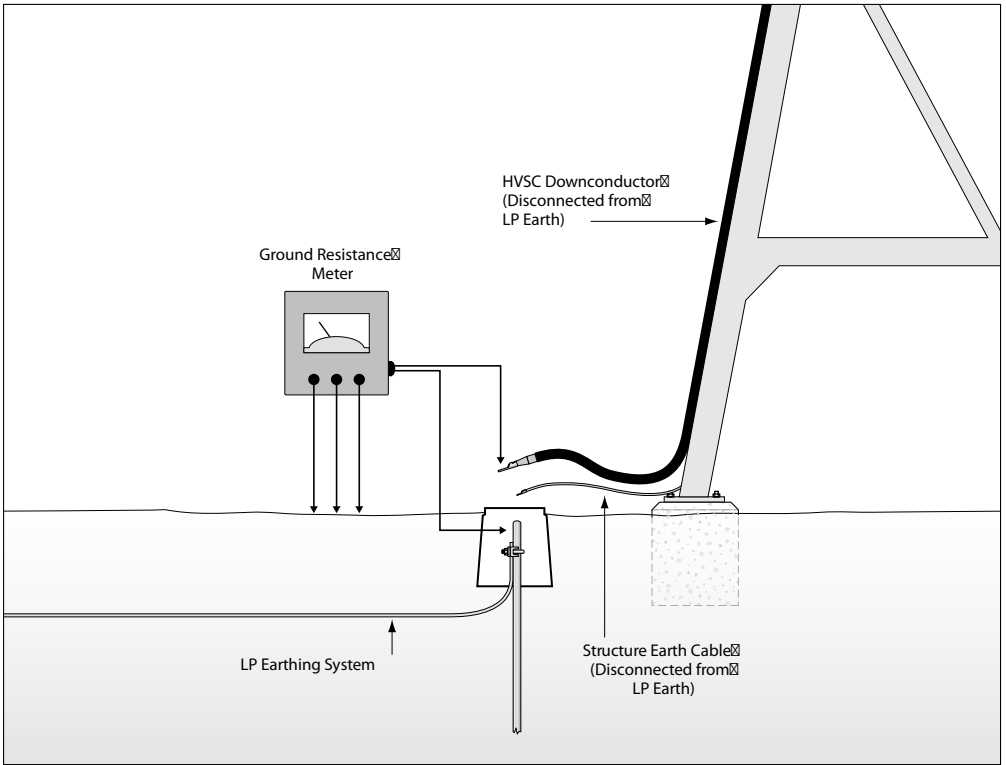

Figure 37.

Date of Inspection	Inspected by:	Earth Resistance Reading #1	Earth Resistance Reading #2	Earth Resistance Reading #3	LSR Reading	Comments