

TBS | Catalogue 2012/2013



# Transient and lightning protection systems

THINK CONNECTED.

## Welcome to Customer Service

---

**Service telephone: +49 (0)2373 89-1500**

---

**Telefax for enquiries: +49 (0)2373 89-7777**

---

**Fax for orders: +49 (0)2373 89-7755**

---

**E-mail: [info@obo.de](mailto:info@obo.de)**

**Internet: [www.obo-bettermann.com](http://www.obo-bettermann.com)**



Use the direct line to OBO Customer Service! We are available on our Service Hotline on +49 (0)2373 89-1500 from 7.30 a.m. to 5.00 p.m. for any questions to do with the OBO complete product range for electrical installations. The newly structured OBO Customer Service can offer you the full service:

- Competent contacts from your region
- All the information on the OBO product range
- Knowledgeable advice on special application topics
- Quick, direct access to all the technical data of the OBO products – we also want to provide the best in customer relations!

# Contents

	Planning aids	5
	Surge protection energy technology, arrester, Type 1	135
	Surge protection energy technology, arrester, Type 1+2	145
	Surge protection energy technology, arrester, Type 2	173
	Surge protection energy technology, arrester, Type 2+3	199
	Surge protection energy technology, arrester, Type 3	209
	Sure protection, photovoltaics	219
	Data and information technology	235
	Protection and spark gaps	287
	Measuring and test systems	291
	Equipotential bonding systems	295
	Earthing systems	309
	Interception and arrester systems	329
	Insulated lightning protection and OBO isCon® system	381
	Directories	397





#### **OBO TBS seminars: First-hand knowledge**

With a comprehensive programme of training courses and seminars on the subject of surge voltage and lightning protection systems, OBO is able to support its customers with specialist knowledge from a single source. Alongside the basic theoretical principles, the programme also deals with practical implementation in everyday applications. Special calculation and application examples round off the comprehensive programme of knowledge transfer.

#### **Invitations to tender, product information and datasheets**

We can make life easier for you: With our comprehensive selection of materials designed for practical applications, which provide you with effective support with the planning and calculation of a project. These include:

- Invitations to tender
- Product information
- Information sheets
- Datasheets









These documents are continually updated and can be downloaded at no charge at any time from the Internet download area at [www.obo.de](http://www.obo.de).

#### **Invitations to tender on the Internet at [www.ausschreiben.de](http://www.ausschreiben.de)**

More than 10,000 entries from the KTS, BSS, TBS, LFS, EGS and UFS ranges can be called up free of charge. Regular updates and expansions mean that you always have a comprehensive overview of the OBO products. All the current file formats – PDF, DOC, GAEB, HTML, TEXT, XML, ÖNORM – are available.

[www.ausschreiben.de](http://www.ausschreiben.de)

## Contents of planning and mounting aids

	Basic principles of surge voltage protection	6
	Surge protection energy technology	19
	Sure protection, photovoltaics	27
	Surge protection device for data and information technology	43
	Protection and spark gaps	65
	Measuring and test systems	69
	Equipotential bonding systems	73
	Earthing systems	77
	Interception and arrestor systems	87
	Insulated lightning protection and OBO isCon® system	113
	Additional information	126



## Minor cause, major effect: Damage caused by surge voltages



Our dependency on electrical and electronic equipment continues to increase, in both our professional or private lives. Data networks in companies or emergency facilities such as hospitals and fire stations are lifelines for an essential real time information exchange. Sensitive databases, e.g. in banks or media publishers, need reliable transmission paths.

It is not only lightning strikes that pose a latent threat to these systems. More and more frequently, today's electronic aids are damaged by surge voltages caused by remote lightning discharges or switching operations in large electrical systems. During thunderstorms too, high volumes of energy are instantaneously released. These voltage peaks can penetrate a building through all manner of conductive connections and cause enormous damage.





### What are the consequences of damage caused by surge voltages in our daily lives?

The most obvious one is the destruction of electrical equipment. In private households, these are specifically:

- TV/DVD players
- Telephone systems
- Computer systems, stereo systems
- Kitchen appliances
- Monitoring systems
- Fire alarm systems

The failure of such equipment certainly incurs great expense. What happens when the following suffer outage times / consequential damage:

- Computers (loss of data)
- Heating/water heating systems
- Lift, garage door and roller shutter drives
- Triggering or destruction of fire / burglar alarm systems (costs through a false alarm)?

A vital topic perhaps, particularly in office buildings, because:

- Can work continue in your company without a central computer / server?
- Was all the important data backed up in time?

### Growing sums of damage

Current statistics and estimates of insurance companies show: Damage levels caused by surges – excluding consequential or outage costs – long since reached drastic levels due to the growing dependency on electronic "aids". It's no surprise, then, that property insurers are checking more and more claims and stipulating the use of devices to protect against surges. Information on protection measures is contained, e.g. in Directive VDS 2010.





## Creation of lightning discharges



Creation of lightning discharges: 1 = approx. 6,000 m, approx.  $-30\text{ }^{\circ}\text{C}$ , 2 = approx. 15,000 m, approx.  $-70\text{ }^{\circ}\text{C}$

### Discharge types

Some 90% of all lightning discharges between a cloud and the ground are negative cloud-earth strikes. The lightning begins in a negatively charged area of the cloud and spreads to the positively charged surface of the earth. Additional discharges are divided into:

- Negative earth-cloud strikes
- Positive cloud-earth strikes
- Positive earth-cloud strikes.

The most common discharges actually occur within a cloud or between different clouds.

### Creation of lightning discharges

When warm, damp air masses rise, the air humidity condenses and ice crystals are formed at great heights. Storm fronts can occur when the clouds expand to heights of up to 15,000 m. The strong upwind of up to 100 kilometres per hour causes the light ice crystals to enter the higher area and the sleet particles enter the lower area. Knocks and friction cause electrical discharge.





### Negative and positive charges

Studies have proved that the sleet falling down (area warmer than  $-15\text{ }^{\circ}\text{C}$ ) has a negative charge and the ice crystals being thrown upwards (area colder than  $-15\text{ }^{\circ}\text{C}$ ) has a positive charge. The light ice crystals are carried into the upper areas of the cloud by the upwind and the sleet falls to the central areas of the cloud. This divided the clouds into the three areas:

- Top: Positively charged zone
- Centre: Weakly negative charged zone
- Bottom: Weakly positive charged zone

This separation of charges forms a voltage in the cloud.



Negative and positive charges: 1 = Sleet, 2 = Ice crystals

### Load distribution

Typical load distribution:

- Positive at the top, negative in the centre and weakly positive at the bottom.
- Positive charges can also be found in the area near the ground.
- The field strength required to trigger lightning is dependent on the insulating ability of the air and is between 0.5 and 10 kV/cm.



Charge distribution: 1 = approx. 6,000 m, 2 = Electrical field



## What are transient surges?

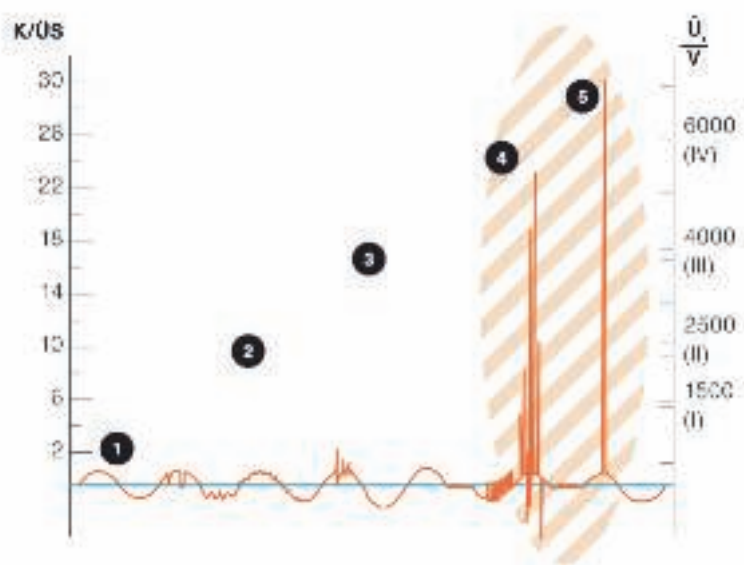

Transient surge voltages: 1 = Voltage drops/brief interruptions, 2 = Harmonic waves through slow and rapid voltage changes, 3 = Temporary voltage increases, 4 = Switching surges, 5 = Lightning surge voltages, hatched = application for surge protection devices

**Transient surge voltages are brief voltage peaks lasting microseconds, which may be a multiple of the attached mains nominal voltage.**

### Direct strike

The largest voltage peaks in the low-voltage consumer network are caused by lightning discharges. The high energy content of lightning surges when a direct strike hits the external lightning protection system or a low-voltage open-wire line usually causes – without internal lightning and surge protection – total outage of the connected consumers and damage to the insulation.

### Induced voltage peaks and switching surge voltages

Yet induced voltage peaks in building installations and energy or data line supply cables can also reach many times the nominal operating voltage. Switching surges too, which in fact do not cause such high voltage peaks as lightning discharges but occur much more frequently, can result in immediate system failure. As a rule, switching surges amount to twice to three times the operating voltage, lightning surges on the other hand can sometimes reach 20 times the nominal voltage value and transport a high energy content.

### Delayed failures

Often, failures occur only after a time delay as the aging process of electronic components in the affected devices triggered by smaller transients causes insidious damage. A number of different protection measures are required. These depend on the exact cause and/or impact point of the lightning discharge.



## What pulse forms are there?

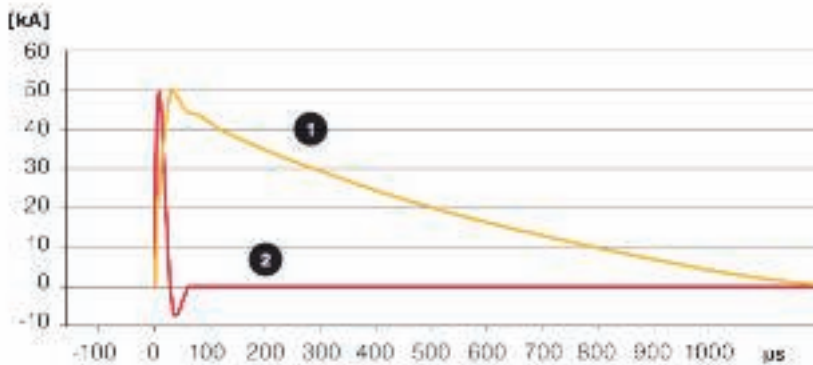

Pulse types and their characteristics: Yellow = pulse shape 1, direct lightning strike, 10/350  $\mu\text{s}$  simulated lightning pulse, red = pulse shape 2, remote lightning strike or switching operation, 8/20  $\mu\text{s}$  simulated lightning pulse (Surge)

### Testing currents simulate potential increase

High lightning currents can flow to the ground during a storm. If a building with external lightning protection receives a direct hit, a voltage drop occurs on the earthing resistor of the lightning protection equipotential bonding system, which represents a surge voltage against the distant environment. This rise in potential poses a threat to the electrical systems (e.g. voltage supply, telephone systems, cable TV, control cables, etc.) that are routed into the building. Suitable test currents for testing different lightning and surge protectors have been defined in national and international standards.

### Direct lightning strike: Pulse shape 1

Lightning currents that can occur during a direct lightning strike can be imitated with the surge current of wave form 10/350  $\mu\text{s}$ . The lightning test current imitates both the fast rise and the high energy content of natural lightning. Lightning current arrester type 1 and external lightning protection components are tested using this current.

### Remote lightning strikes or switching operations: Pulse shape 2

The surges created by remote lightning strikes and switching operations are imitated with test impulse 8/20  $\mu\text{s}$ . The energy content of this impulse is significantly lower than the lightning test current of surge current wave 10/350  $\mu\text{s}$ . Surge arrester type 2 and type 3 are impacted with this test impulse.



## Causes of lightning currents

### Direct lightning strike into a building

If a lightning strike hits the external lightning protection system or earthed roof structures capable of carrying lightning current (e.g. roof aerial), then the lightning energy can be arrested to the ground in advance. However, a lightning protection system on its own is not enough: Due to its impedance, the building's entire earthing system is raised to a high potential. This potential increase causes the lightning current to spill over the building's earthing system and also over the power supply systems and data cables to the adjacent earthing systems (adjacent building, low-voltage transformer).

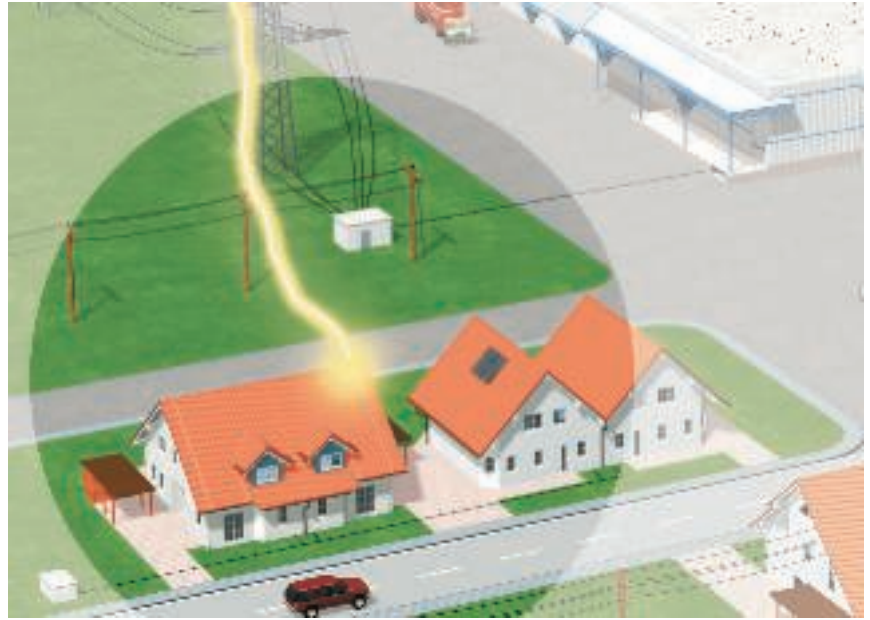

#### Risk:

Lightning impulse (10/350)

### Direct lightning strike into a low-voltage open-wire line

A direct lightning strike into a low-voltage open wire line or data cable can couple high partial lightning currents in an adjacent building. Electrical equipment in buildings at the end of the low-voltage open-wire line are at particular risk of damage caused by surges.

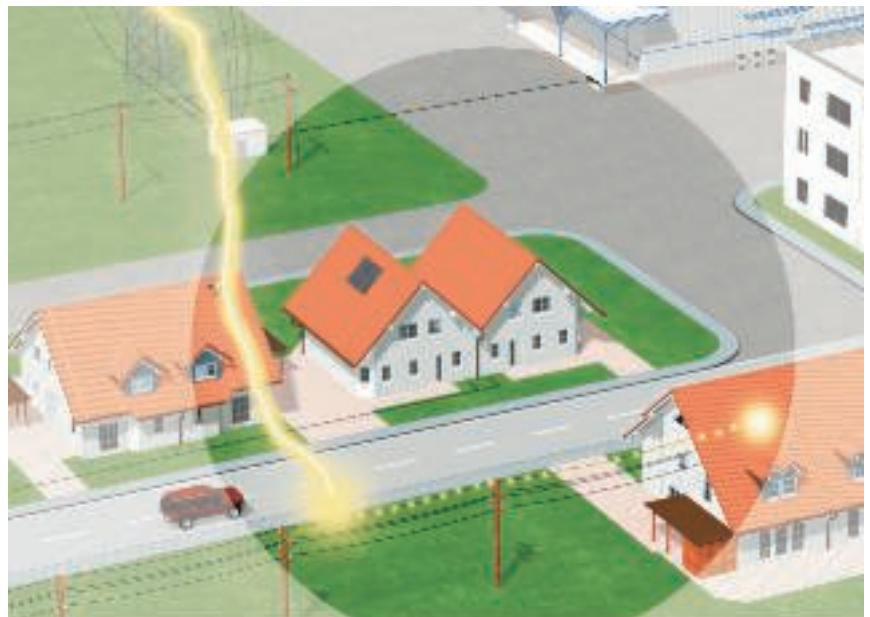

#### Risk:

Lightning impulse (10/350)

## Causes of surges

### Switching surges in the low-voltage system

Switching surges are caused by switch-on and switch-off operations, by switching inductive and capacitive loads and by interrupting short-circuit currents. Particularly when production plants, lighting systems or transformers are switched off, electrical equipment located in close proximity can be damaged.

---

**Risk:**  
Surge impulse (8/20)

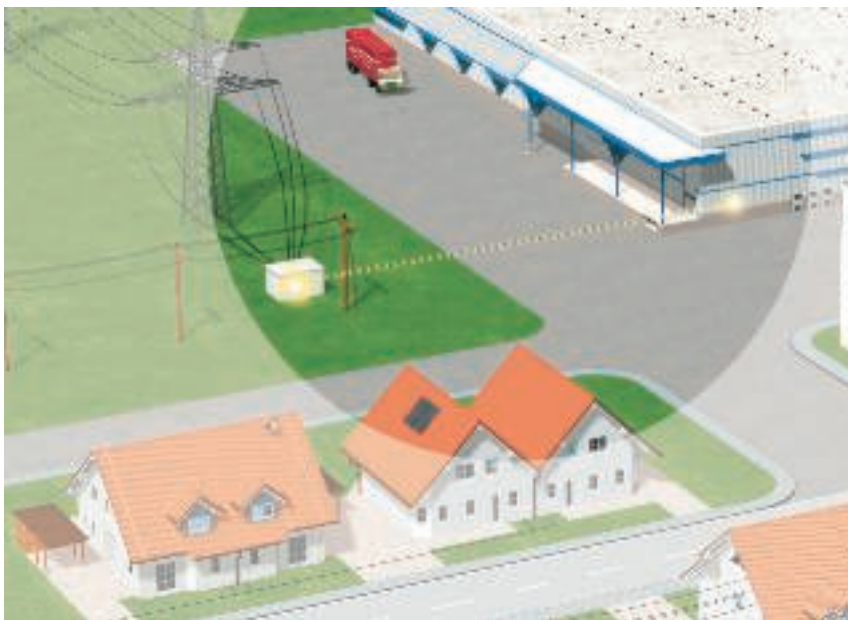

### Coupling of surges through local or remote lightning strike

Even if lightning protection and surge protection measures are already installed: A local lightning strike creates additional high magnetic fields, which in turn induce high voltage peaks in line systems. Inductive or galvanic coupling can cause damage within a radius of up to 2 km around the lightning impact point.

---

**Risk:**  
Surge impulse (8/20)

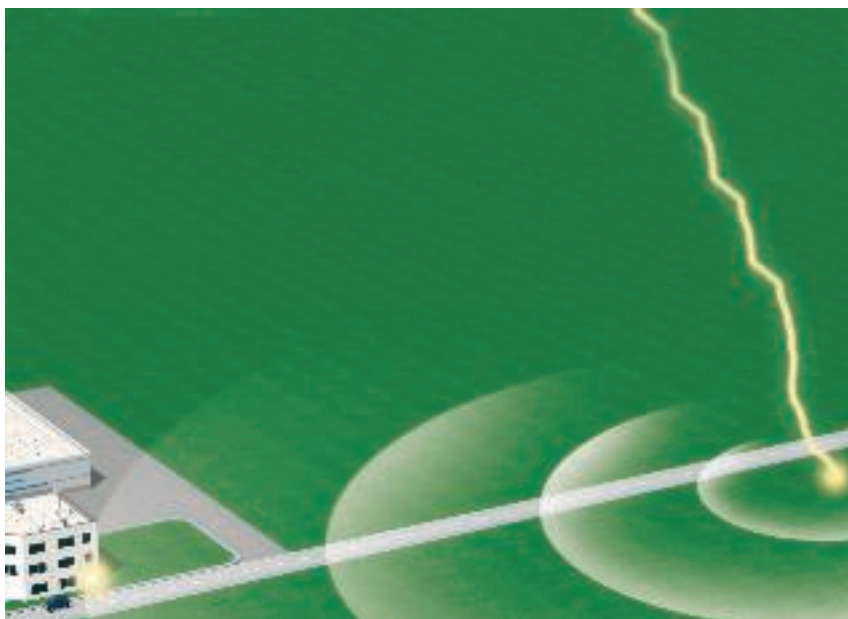



## Gradual surge reduction with lightning protection zones



### Lightning protection zone concept

The lightning protection zone concept described in international standard IEC 62305-4 (DIN VDE 0185 Part 4) has proved to be practical and efficient. This concept

is based on the principle of gradually reducing surges to a safe level before they reach the terminal device and cause damage. In order to achieve this situation, a building's entire energy network is split into lightning protection zones (LPZ = Lightning Protec-

tion Zone). Installed at each transition from one zone to another is a surge arrester for equipotential bonding. These arrestors correspond to the requirement class in question.

### Lightning protection zone

LPZ 0 A		Unprotected zone outside the building. Direct lightning strike, no shielding against electromagnetic interference pulses LEMP (Lightning Electromagnetic Pulse)
LPZ 0 B		Through the area protected by the external lightning protection system. No shielding against LEMP.
LPZ 1		Zone inside the building. Low partial lightning energies possible.
LPZ 2		Zone inside the building. Low surges possible.
LPZ 3		Zone inside the building (can also be the metal housing of a consumer). No interference pulses through LEMP or surges present.



## Zone transitions and protective devices

### Benefits of the lightning protection zone concept

- Minimisation of the couplings into other cable systems through arresting the energy-rich, dangerous lightning currents directly at the point the cables enter the building.
- Malfunction prevention with magnetic fields.
- Economic, well-plannable individual protection concept for new and old buildings and reconstructions.



### Type classes of the surge protection devices

OBO surge protection devices are classified in accordance with DIN EN 61643-11 into three type classes – type 1, type 2 and type 3 (previously B, C and D). These standards contain building regulations, requirements and tests for surge arrestors used in AC networks with nominal voltages of up to 1,000 V and nominal frequencies of between 50 and 60 Hz.

### Correct selection of the arrestor

This classification enables arrestors to be matched to different requirements with regard to location, protection level and current-carrying capacity. The table below provides an overview of the zone transitions. It also shows which OBO surge protection devices can be installed in the energy supply network and their respective function.

### Zone transitions

Zone transition	Protection device and device type	Product example	Product figure
LPZ 0 B to LPZ 1	Protection device for lightning protection equipotential bonding in accordance with DIN VDE 0185-3 for direct or close lightning strikes. <ul style="list-style-type: none"> <li>• Devices: type 1 (Class I, requirements class B), e.g. MC50-B</li> <li>• Max. protection level according to standard: 4 kV</li> <li>• Installation e.g. in the main distributor/at building entry</li> </ul>	MCD Item no.: 5096 87 9	
LPZ 1 to LPZ 2	Protection device for surge protection to DIN VDE 0100-443 for surge voltages arriving through the supply network due to remote strikes or switching operations. <ul style="list-style-type: none"> <li>• Devices: type 2 (Class II, requirements class C), e.g. V20-C</li> <li>• Max. protection level according to standard: 2.5 kV</li> <li>• Installation e.g. in the power distributor, subdistributor</li> </ul>	V20 Item no.: 5094 65 6	
LPZ 2 to LPZ 3	Protection device, designed for surge protection of portable consumers at sockets and power supplies. <ul style="list-style-type: none"> <li>• Devices: type 3 (Class III, requirements class D), e.g. FineController FC-D</li> <li>• Max. protection level according to standard: 1.5 kV</li> <li>• Installation e.g. on the end consumer</li> </ul>	FC-D Item no.: 5092 80 0	



## BET – testing centre for lightning protection, electrical engineering and support systems



Lightning current test

### BET with countless tasks

If only lightning current, environmental and electrical testing was possible at BET up to now, the BET Test Centre is now a competent partner for testing of cable support systems. This combination has made it necessary to revise the meaning of the name. If BET previously stood for "Blitzschutz- und EMV-Technologiezentrum" (Lightning protection and EMC technology centre), since 2009 these letters have meant BET Test centre for lightning protection, electrical engineering and support systems.

### Test generator for lightning current tests

The test generator planned in 1994 and completed in 1996 makes it possible to carry out lightning current tests at up to 200 kA. The generator was planned and constructed in cooperation with the Soest Technical College. Due to the intensive planning and scientific support in the construction of the test system, it has worked for 12 years without errors and meets current standardised test requirements.

### Testing tasks

The main load of the testing generator is generated through the testing of products from the TBS product division. For this, developmental tests of new developments, modifications to existing OBO products and also comparison tests with competitive products are carried out. These include lightning protection components, surge protection devices and lightning arrestors. Tests for lightning protection components are carried out according to DIN EN 50164-1, for spark gaps according to DIN EN 50164-3 and for lightning and surge protection devices according to DIN EN 61643-11. This is only a small amount of the testing standards used for tests in the BET Test Centre.





Load test

### Testing types for lightning and surge protection

Both lightning current tests and surge voltage tests can be carried out at up to 20 kV. A hybrid generator is used for these tests, which was also developed as part of a cooperation with the Soest Technical College. EMC testing of cable support systems can also be carried out using this test generator. All kinds of cable routing and cable support systems of up to 8 m length can be tested without any difficulties. Tests for electrical conductivity according to DIN EN 61537 are also carried out.

### Simulation of real environmental conditions

To carry out standardised tests on components intended for external use, they must be pretreated under real environmental conditions. This takes place in a salt spray trough and a sulphur dioxide testing chamber. Depending on the test, the test length and the concentration of the salt spray or sulphur dioxide in the testing chambers may vary. This means that it is possible to conduct tests according to IEC 60068-2-52, ISO 7253, ISO 9227 and EN ISO 6988.

### Testing cable support systems

The well-known KTS testing system, newly installed in the BET Test Centre, allows the investigation of the load capacities of any cable support system manufactured by OBO. The basis for this is DIN EN 61537 and VDE 0639. In the BET Test Centre, OBO Bettermann has a testing department in which products can be tested according to standards, even during the development phase.



# Planning aids, surge protection device for data and information technology



Standards, data and information technology	44
Important terms and basic principles	45
Network topologies	46
Installation instructions, lightning barriers	48
Limit frequency and installation instructions	50
Equipotential bonding of data cables	51
Terms and explanations on PC interfaces	52
Selection aids, surge protection	54



Various standards have a role in the field of data and telecommunications technology. From structured building cabling through equipotential bonding up to EMC, various different standards must be taken into account. Some important standards are listed here.

Standard	Contents
IEC 61643-21	Low voltage surge protective devices – Part 21: Surge protective devices connected to telecommunications and signalling networks. Power requirements and testing method.
DIN EN 50173-1	Information technology – Generic cabling systems – Part 1: General requirements
DIN VDE 0845-1	Protection of telecommunication systems against lightning, electrostatic discharges and surge voltages from electric power installations; provisions against surge voltages.
DIN VDE 0845-2	Protection of data processing and telecommunications equipment against the impact of lightning, discharge of static electricity and surge voltages from heavy current systems – Requirements and tests of surge voltage protection devices
DIN EN 50310 (VDE 0800-2-310)	Application of equipotential bonding and earthing in buildings with information technology equipment.
EN 61000-4-5 (VDE 08457-4-5)	Electromagnetic Compatibility (EMC) – Part 4-5: Testing and measurement techniques – Surge immunity test.
EN 60728-11 (VDE 855-1)	Cable networks for television signals, sound signals and interactive services – Part 11: Safety (IEC 60728-11:2005).

## Important terms and basic principles

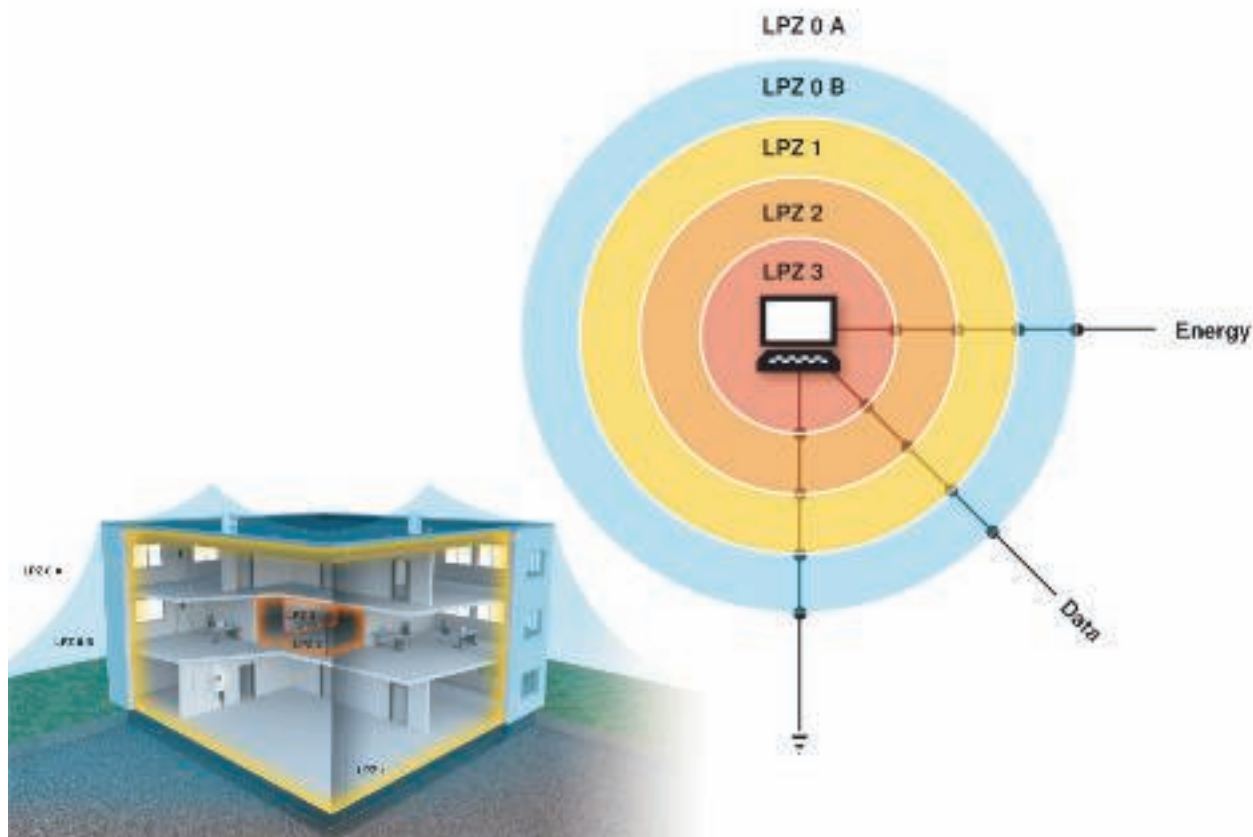

### Basic principles

These days, communication and IT systems are the lifelines of almost every company. In the worst-case scenario, surge voltages, caused by galvanic, capacitive or inductive couplings in data cables, can destroy IT equipment and communication technology. To avoid such failures, suitable protection measures have to be taken.

In practice, the wide range of standard information, telecommunication and measurement systems often makes the selection of the right surge protection device complex. The following factors must be taken into account:

- The connection system of the protection device must fit the device to be protected.
- Parameters such as the highest signal level, highest frequency, maximum protection level and the installation environment must be taken into account.
- The protection device may only exert the minimum of impacts, such as attenuation and

reflection, on the transmission path.

### Protection principle

A device is only protected against surge voltages if all energy and data cables connected to the device are integrated into the equipotential bonding system at the lightning protection zone transitions (local equipotential bonding). OBO Bettermann offers a complete range of tried-and-tested, highly functional and reliable data cable protection devices for all standard telecommunication and information technology systems.





## Network topologies

### Bus topology

In a bus topology, all users are connected in parallel. At its end, the bus must have an anechoic closure. Typical applications are 10Base2, 10Base5 and machine controllers such as PROFIBUS and telecommunication systems such as ISDN.

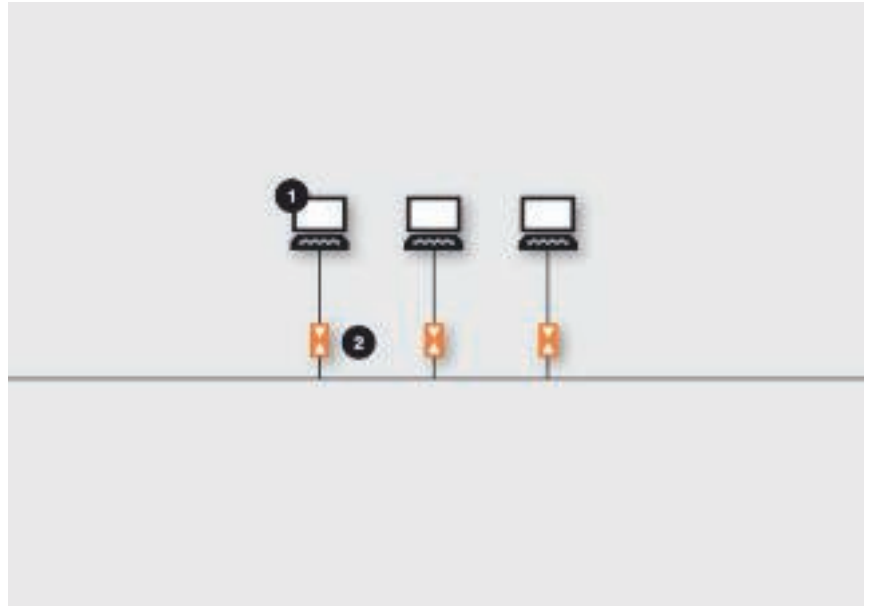

1 = IT devices, 2 = Surge protection devices

### Star networks

In a star network, every workstation is supplied by a separate cable from a central star point (HUB or Switch). Typical applications are 10BaseT and 100BaseT.

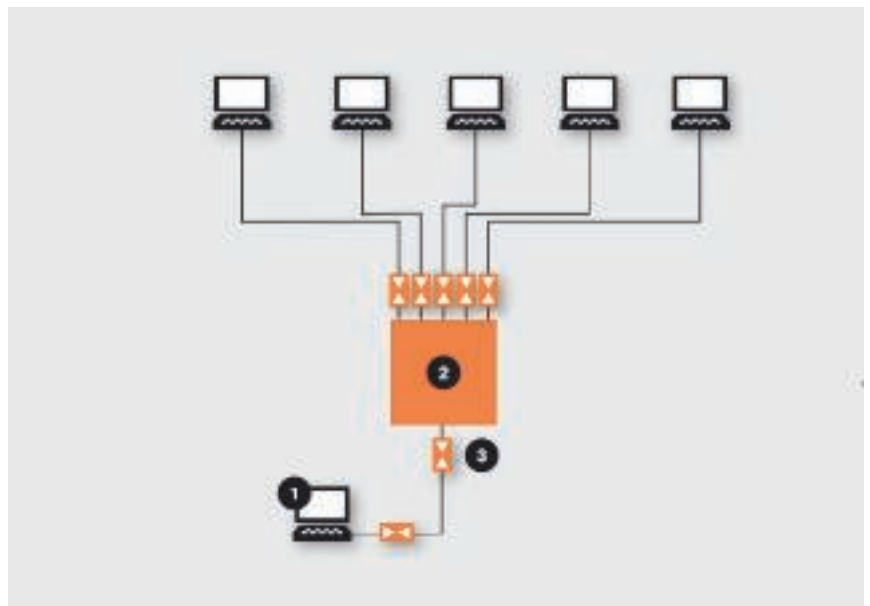

1 = Server, 2 = Switch/Hub, 3 = Surge protection devices

# Network topologies and connection types

## Ring topology

In a ring topology, every workstation is connected to precisely one predecessor and one successor via a ring-shaped network. If one station fails, the entire network fails. Ring networks, e.g. in Token Ring applications.

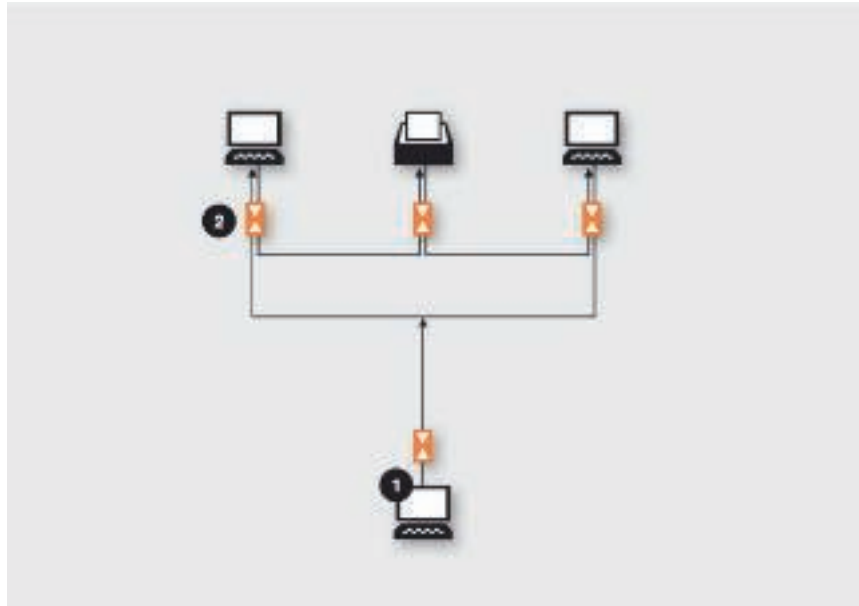

The number of wires varies according to the network type. 1 = Server, 2 = Ground floor

## Telephone systems

In many cases, modern telephone systems also act as interfaces for a number of different data services, e.g. the Internet. Many terminal devices that enable this access are connected into the lines themselves and must be integrated into the surge protection concept accordingly. As there are now a number of different systems, these devices must have selective protection. There are three distinctly different essential systems:

### Standard analogue connection

Unlike other systems, the standard analogue connection offers no additional services. One or several telephones are wired in a star-shape and ring simultaneously when a call comes in. Access to the Internet is via a separate modem. Because the analogue connection without technical accessories provides only one channel, the Internet cannot be accessed while telephoning and likewise, no telephone call is possible while surfing.

## ISDN (Integrated Services Digital Network System)

In contrast to the analogue connection, ISDN allows two conversations to take place at the same time via a special bus system (S0 bus), which provides two channels. This enables the user to surf on the Internet while telephoning and at higher data rates than is possible with the analogue connection (64 kBit/s over one channel). ISDN also offers other services such as call-waiting, call-back, etc.

## DSL system (Digital Subscriber Line)

Today, the most commonly used system is the DSL system. Speech and data channels are separated by splitters and the data channel is routed to a special modem (NTBBA), which is connected to the PC via a network card. DSL data rates are higher than those of analogue and ISDN systems and therefore enable fast downloading of music and films from the Internet. Because there are a number of different DSL versions such as A-DSL and S-DSL, the general DSL is also designated X-DSL. X-DSL permits the use of analogue telephones without additional hardware, as well as a combination with ISDN.





## Type differences, lightning barriers

### FRD/FLD

Lightning barriers TKS-B, FRD, FLD, FRD 2 and FLD 2 protect electronic measuring, controlling and regulating systems from surges. Lightning barriers of type MDP are used in areas requiring particularly small installation widths with simultaneously high numbers of poles.

Type FRD, FLD and MDP lightning barriers are designed for use in so-called floating (asymmetrical, potential-free) two-core systems. These are systems whose signal circuits have no common reference potential with other signal circuits, e.g. 20 mA current loops. These devices can be used universally.

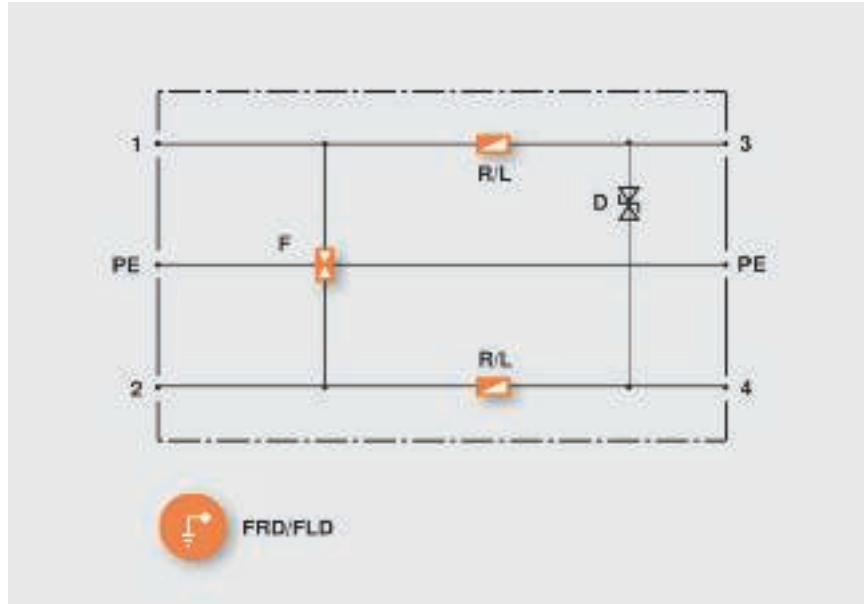

Circuit diagram of the lightning barrier FRD/FLD

### FRD2/FLD2

Type FRD2 and FLD2 are intended for use in ground-referenced (symmetrical, potential-referenced) single-wire systems.

Earth-referenced systems are signal circuits that have a common reference potential with other signal circuits. In these systems, two further data cables besides earth are protected. The decision to use FRD (with resistive decoupling) or FLD (with inductive decoupling) depends on the system to be protected.

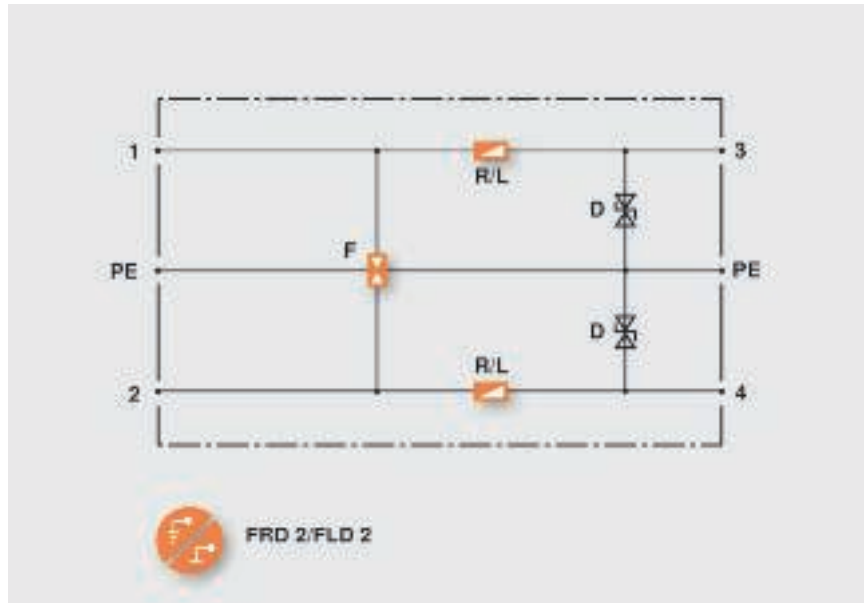

Circuit diagram of the lightning barrier FRD2/FLD2



# Lightning barriers in measurement circuits and terms for HF technology

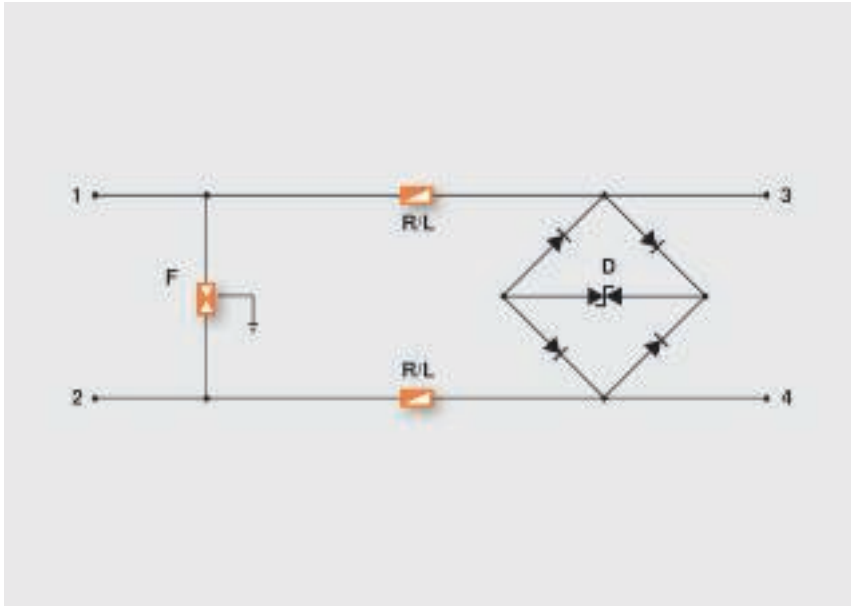

Basic protection circuit in measuring circuit

## Use of lightning barriers in measuring circuits

Before lightning barriers are used in measuring circuits, it must first be confirmed whether a resistance increase is permitted. Depending on the decoupling, resistance increases in the measuring circuits can occur with types FRD and FRD2. This can result in errors with current loop measurements. FLD/FLD2 and/or MDP devices should therefore be used in this case. The maximum operating current should also be verified to ensure that the dissipated energy does not cause thermal destruction of the decoupling elements.

In the case of arrestors with integrated inductivities for decoupling, the signal is attenuated at high transfer frequencies. Therefore, when used in measuring circuits with high transfer frequencies, lightning barriers with resistive decoupling elements are the preferred solution.

## Insertion loss

Insertion loss describes the damping of a system from input to output. It shows the transfer function of the system and accommodates the 3 dB point (see figure Limit frequency).

## Return loss

This parameter indicates in dB how much input power is reflected back. In 50  $\Omega$  systems, these values are around -20 dB. This value is important for antenna systems. In the case of arrestors with integrated inductivities for decoupling, the signal is damped at high transfer frequencies. Therefore, when used in measuring circuits with high transfer frequencies, lightning barriers with resistive decoupling elements are the preferred solution.





## Terms for HF technology and installation instructions

### Cut-off frequency $f_g$

The cut-off frequency  $f_g$  describes the frequency-dependent behaviour of the arrester. Capacitive and/or inductive component properties ensure signal damping at higher frequencies. The critical point is described as the cut-off frequency  $f_g$ . From this point onwards, the signal has lost 50% (3 dB) of its input power. The cut-off frequency is determined according to certain measuring criteria. Usually, in the absence of any values, the cut-off frequency relates to so-called 50  $\Omega$  systems.

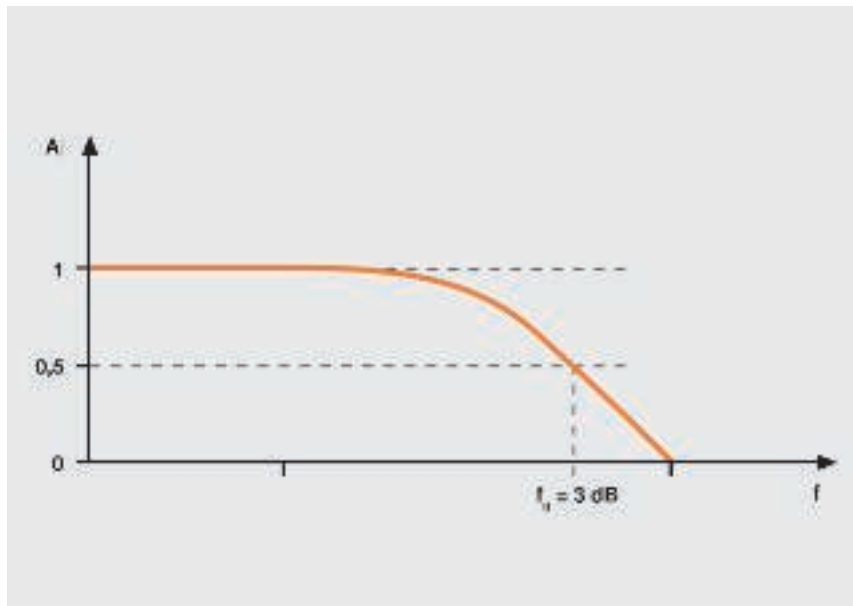

Attenuation curve in the Bode diagram

### Installation instructions

The surge protection device must be connected as close as possible to the device to be protected. The housing of the device to be protected should if necessary be defined as a local earthing point. In addition, care should be taken to ensure short PE line distances from surge protection device to earthing point (housing) – line length max. 0.5 m.

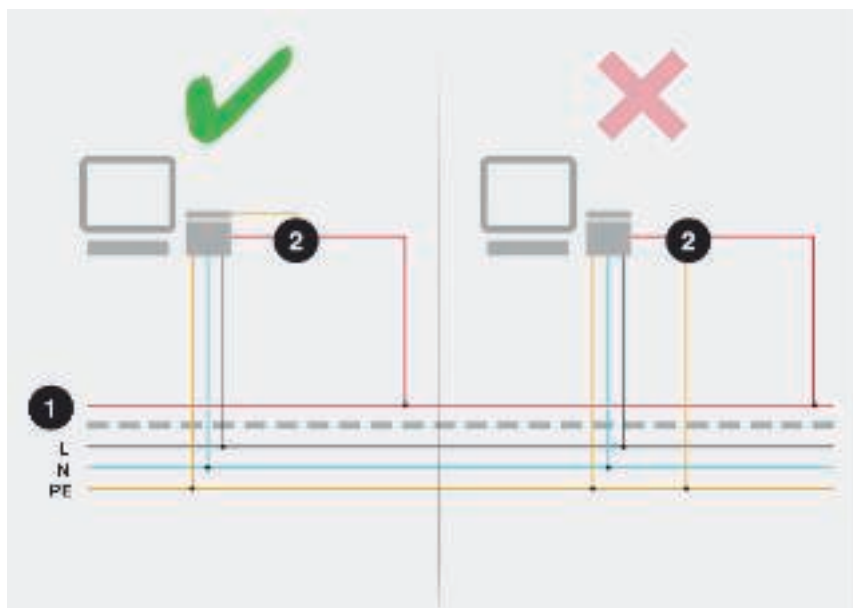

Installation information: 1 = ISDN, 2 = Protection device

# Equipotential bonding of data cables

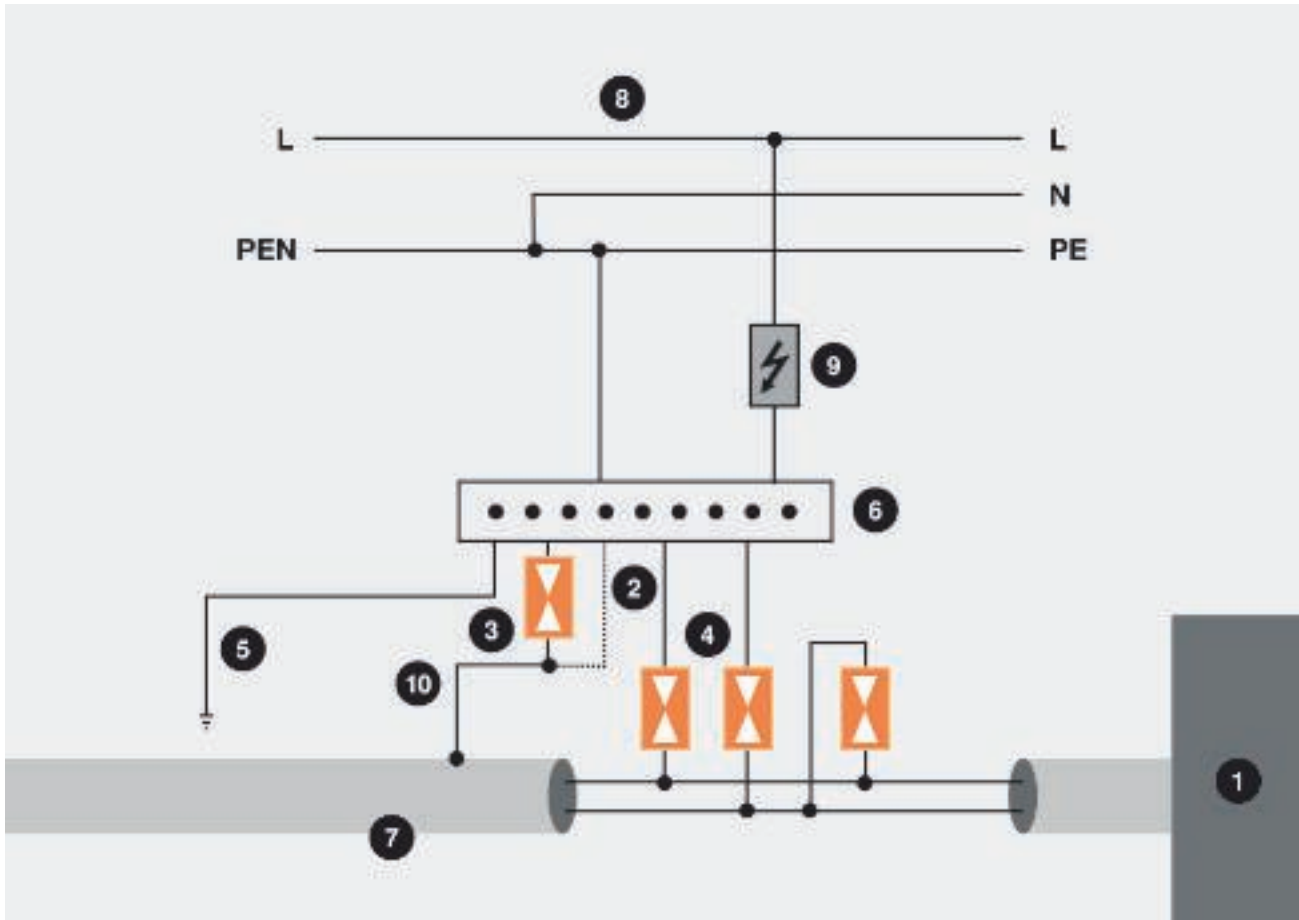

## Equipotential bonding of data cables

In contrast to energy technology, data technology has lengthwise and transverse voltages, which must be minimised using suitable arrestors with voltage-limiting components.

To achieve low protection levels, these surge protection devices must be included in the equipotential bonding via the shortest route. Long cable routes should be avoided. The best solution is local equipotential bonding.

The inclusion of the shields is also of key importance. Complete shield action against capacitive and inductive coupling can only be effective when the shield is included with low impedance on both sides in the equipotential bonding.

1	Device to be protected/telecom line
2	Direct connection to equipotential bonding (preferred)
3	Gas discharge arrester (indirect shielding)
4	Gas discharge arrester
5	Connection to equipotential bonding
6	Equipotential bonding rail
7	Telecommunications line
8	Electrical energy cable
9	Surge protection device (energy technology)
10	Conductive shield of the data cable



## Terms and explanations for PC interfaces

### Interfaces

External devices such as printers, scanners and control systems activated via serial or parallel interfaces must be additionally integrated into the surge protection concept.

#### RS232 interface

The RS232 is a frequently used interface. It is often used, for example, for modems and other peripherals. Although now largely replaced by the USB interface, the RS232 standard is still frequently used for control cables.

#### TTY system

Unlike the RS232 or other serial interfaces, the TTY system is not voltage-controlled - instead it delivers an imposed current (4-20 mA). This enables cable lengths of up to several hundred metres to be realised.

There is a range of interfaces for different applications: from bus lines for telecommunication and data transfer through to simple terminal devices such as printers or scanners. OBO also offers a host of protective devices that are simple to install, depending on the particular application.



#### RS422

The RS422 is a serial high-speed standard suitable for communication between a maximum of ten users, which is designed as a bus. The system can be designed for a maximum of eight data cables, although two are always used as send and receive cables.

#### V11 interface

V11 is the German designation for the RS422. The American nomenclature, however, is the most widely used.

#### RS485 interface

The RS485 industrial bus interface differs slightly from the RS422 in that the RS485 enables the connection of several transmitters and receivers (up to 32 users) via a protocol. The maximum length of this bus system, when twisted-pair cables are used, is approx. 1.2 km with a data rate of 1 MBit/s (dependent upon serial controllers).

#### V24 interface

V24 is the German designation for the RS232. The American nomenclature, however, is the most widely used.





# Selection aid Telecommunications systems



Planning aids, surge protection device for data and information technology













Planning aids, surge protection device for data and information technology

## Selection aid MSR systems



**Installation location 2  
Protection on the sensor**

Description	Type	Item no.	Test mark	Product figure
Protection of up to 10 two-core wires (select appropriate accessories) (please order connection strip 5084008 as well)	LSA-MAG	<b>5084 02 0</b> Page: 241		
2-wire protection for high peak currents	TKS-B	<b>5097 97 6</b> Page: 265		
4-wire protection with test function	MDP-4/D-24-T	<b>5098 43 1</b> Page: 275	UL	
4-wire protection with test function	MDP-4/D-24-T	<b>5098 43 1</b> Page: 275	UL	
2-wire protection	FLD 24	<b>5098 60 3</b> Page: 269	UL	
2-wire protection for HF applications	FRD 24 HF	<b>5098 57 5</b> Page: 265	UL	
2-wire protection for high peak currents	TKS-B	<b>5097 97 6</b> Page: 265		
4-wire protection with test function	MDP-4/D-24-T	<b>5098 43 1</b> Page: 275	UL	
Protection of RS232 applications	SD25-V24 25	<b>5080 27 4</b> Page: 255		

02\_TBS\_Masterkatalog\_Länder\_2012 / en / 29/05/2012 (LLExpert\_01433) / 29/05/2012











Planning aids, surge protection device for data and information technology

## Selection aid MSR systems

**Installation location 2  
Protection on the sensor**

Description	Type	Item no.	Test mark	Product figure
4-wire protection with test function and nominal currents up to 10 A	MDP-4/D-24-T	<b>5098 43 3</b> Page: 279	UL	
2-wire protection without testing point	TKS-B	<b>5097 97 6</b> Page: 265		
Intrinsically safe surge protection for 3 cables in the housing (metric thread)	FDB-3-24-M	<b>5098 38 2</b> Page: 282	Ex	
Intrinsically safe surge protection for 3 cables in the housing (NPT thread)	FDB-3-24-N	<b>5098 39 2</b> Page: 282	Ex	
4-wire protection to 5 V, Ex tested	MDP-4/D-5-EX	<b>5098 41 2</b> Page: 284	Ex	
4-wire protection to 24 V, Ex tested	MDP-4/D-24-EX	<b>5098 43 2</b> Page: 284	Ex	
4-wire protection to 48 V, Ex tested	MDP-4/D-48-EX	<b>5098 45 2</b> Page: 284	Ex	

02\_TBS\_Masterkatalog\_Länder\_2012 / en / 29/05/2012 (LLExport\_01433) / 29/05/2012



## Selection aid Data technology / network technology



Planning aids, surge protection device for data and information technology

**Installation location 2  
Protection on the terminal**

Description	Type	Item no.	Product figure
-------------	------	----------	----------------

Data cable protection for channel CLASS EA	Net Defender	<b>5081 80 0</b> Page: 250	
--	--------------	-------------------------------	---



Data cable protection for channel up to Class D	RJ45-ATM/8-F	<b>5081 79 3</b> Page: 250	
---	--------------	-------------------------------	---



Fine protection with BNC connection (Class C)	CoaxB-E2/MF-F	<b>5082 42 0</b> Page: 250	
---	---------------	-------------------------------	---



Fine protection for 230 V power supply, connectable	FC-D	<b>5092 80 0</b> Page: 210	
---	------	-------------------------------	---



Fine protection for hat rail installation	VF 230-AC/DC	<b>5097 65 0</b> Page: 215	
---	--------------	-------------------------------	---





















Planning aids, surge protection device for data and information technology

## Selection aid Antennas



## Test marks





	Lightning current-tested
	Lightning current-tested, Class H (100 kA)
	ELEKTROTECHNICKÝ ZKUŠEBNÍ ÚSTAV, Czech Republic
	ATEX certificate for explosive areas
	Russia, GOST The State Committee for Standards
	KEMA-KEUR, Netherlands
	Indication of metric products
	MAGYAR ELEKTROTECHNIKAI ELLENŐRZŐ INTÉZET Budapest, Hungary
	Österreichischer Verband für Elektrotechnik, Austria
	Underwriters Laboratories Inc., USA
	Eidgenössisches Starkstrominspektorat, Switzerland
	Underwriters Laboratories Inc., USA
	Verband der Elektrotechnik, Elektronik, Informationstechnik e.V., Germany
	German Association of Electricians, tested safety
	5-year warranty
	Halogen-free; without chlorine, fluorine and bromine











# Pictogram explanation



















## Lightning protection classes

	Protection device to DIN EN 61643-11 or IEC 61643-11
	Combination protection device made of type 1 and type 2
	Protection device to DIN EN 61643-11 or IEC 61643-11
	Protection device to DIN EN 61643-11 or IEC 61643-11
	Protection device to DIN EN 61643-11 or IEC 61643-11

## Lightning protection zone

	Transition from LPZ 0 to LPZ 1
	Transition from LPZ 0 to LPZ 2
	Transition from LPZ 0 to LPZ 3
	Transition from LPZ 1 to LPZ 2
	Transition from LPZ 1 to LPZ 3
	Transition from LPZ 2 to LPZ 3

## Applications

	Remote signalling
	Remote signalling with fuse monitoring
	Acoustic signalling
	Integrated Service Digital Network, ISDN applications
	Digital Subscriber Line, DSL applications
	Analogue telecommunication
	Category 5 TwisterPair
	Channel Performance to American EIA/TIA standard
	Measuring, controlling and regulating systems
	TV applications
	SAT-TV applications
	Multibase base
	LifeControl
	Intrinsically safe protection device for areas with a risk of explosions
	Channel Performance to ISO / IEC 11801
	Power over Ethernet
	230/400 V system
	Metric







## Applications

	Degree of protection of enclosure IP 65
---	---







## Metals

	Aluminium
	Stainless steel, grade 304
	Stainless steel, grade 316
	Stainless steel, grade 316 L
	Stainless steel, grade 316 Ti
	Copper
	Brass
	Steel
	Cast iron
	Die-cast zinc

## Plastics

	Fibre-glass-reinforced plastic
	Petrolatum
	Polyamide
	Polycarbonate
	Polyethylene
	Polypropylene
	Polystyrene

## Surfaces

	Strip-galvanised
	Hot-dip galvanised
	Electro-galvanised
	Hot-dip galvanised
	Copper-plated
	Nickel-plated
	Galvanised, Deltatone 500



## Metallic materials

**Alu** — Aluminium

**VA (1.4301)** — Stainless steel, grade 304

**VA (1.4401)** — Stainless steel, grade 316

**VA (1.4404)** — Stainless steel, grade 316 L

**VA (1.4571)** — Stainless steel, grade 316 Ti

**Cu** — Copper

**CuZn** — Brass

**St** — Steel

**TG** — Cast iron  
Electrogalvanised

**Zn** — Die-cast zinc

# Plastic materials

## GFK — Fibre-glass-reinforced plastic

Temperature resistance:  
-50 to 130 °C.

### Resistant to

High chemical resistance  
Corrosion resistance  
UV light resistance

## PETR — Petrolatum

## PA — Polyamide

Temperature resistance:  
permanently up to approx. 90 °C, briefly up to about 130 °C  
and to about minus 40 °C\*.

Chem. resistance generally as for polyethylene.

### Resistant to

Petrol, benzene, diesel oil, acetone, solvents for paints and lacquers,  
oils and greases.

### Unstable with

Bleach, most acids, chlorine.

### Risk of tension cracking

Low in air-humid conditions; only with some aqueous salt solutions.  
Highly desiccated parts (high temperature and extremely low air  
humidity) are highly sensitive to fuels and various solvents.

## PA/PP — Polyamide/Polyethylene

## PC — Polycarbonate

Temperature resistance:  
permanently up to approx. 110 °C (in water 60 °C), briefly up to 125  
°C, and to below minus 35 °C.

### Resistant to

Petrol, turpentine, most weak acids.

### Unstable with

Acetone, benzene, chlorine, methylene chloride, most concentrated  
acids.

### Risk of tension cracking

Relatively low.

Media which can cause tension cracking include benzene, aromatic  
hydrocarbons, methanol, butanol, acetone, turpentine.

## PE — Polyethylene

Temperature resistance:  
hard types permanently up to about 90 °C, briefly up to about 105 °C,  
soft types permanently up to about 80 °C, briefly up to about 100 °C  
and to about minus 40 °C\*.

### Resistant to

Alkalis and inorganic acids.

### Conditionally resistant to

Acetone, organic acids, petrol, benzene, diesel oil, most oils.

### Unstable with

Chlorine, hydrocarbons, oxidising acids.

### Risk of tension cracking

Relatively high.

Stress cracks can be caused by, among other things, acetone, various  
alcohols, formic acid, ethanol, petrol, benzene, butyric acid, acetic acid,  
formaldehyde, various oils, petroleum, propanol, nitric acid,  
hydrochloric acid, sulphuric acid, soap solutions, turpentine,  
trichloroethylene, citric acid.

## PP — Polypropylene

Temperature resistance:  
permanently up to approx. 90 °C, briefly up to about 110 °C  
and to about minus 30 °C\*.

Chem. resistance generally as for polyethylene.

### Resistant to

Alkalis and inorganic acids.

### Conditionally resistant to

Acetone, organic acids, petrol, benzene, diesel oil, most oils.

### Unstable with

Chlorine, hydrocarbons, oxidising acids.

### Risk of tension cracking

Low, only with some acids such as chromic acid, hydrofluoric acid and  
hydrochloric acid, as well as nitrogen oxide.

## PS — Polystyrene

Temperature resistance:

Because of its relatively high sensitivity to the effects of chemicals, its  
use is not recommended at temperatures above normal room  
temperature, about 25 °C.

Resistance to cold: to about minus 40 °C\*.

### Resistant to

Alkalis, most acids, alcohol.

### Conditionally resistant to

Oils and greases.

### Unstable with

Butyric acid, concentrated nitric acid, concentrated acetic acid,  
acetone, ether, petrol and benzene, solvents for paints and lacquers,  
chlorine, diesel fuel.

### Risk of tension cracking

Relatively high.

Stress cracks can be caused by, amongst other things, acetone, ether,  
petrol, cyclohexane, heptane, methanol, propanol and the softeners  
used in some PVC cable mixes.

\*The minus values apply only for parts in the quiescent condition with  
no severe impact stress.

There is no plastic that is resistant to every chemical. The agents listed  
are only a small selection. Plastic parts are especially at risk in the  
presence of chemicals and high temperatures. Stress cracks may  
occur. If in doubt, please consult us and/or ask for a detailed chemical  
resistance table.

Stress crack formation: stress cracks may occur if plastic parts under  
tension are exposed to chemicals at the same time. Parts made of  
polystyrene and polyethylene are particularly susceptible. Stress cracks  
may even be caused by agents to which the plastic in question is  
resistant in the absence of stress. Typical examples of parts under  
constant stress when used as intended: grip clips, intermediate  
supports of cable glands, ribbon clips.



# Tested lightning protection components

## Tightening torques

M5 = 4 Nm

M6 = 6 Nm

M8 = 12 Nm

M10 = 20 Nm

Detailed data can be provided on request.

# Brief glossary of overvoltage protection

## 100% response lightning impulse voltage

The 100% response lightning impulse voltage is the value of the lightning impulse voltage 1.2/50  $\mu$ s, causing the arrester to switch. With this testing voltage, the surge protection device must respond ten times to ten loads.

## Arrestor

Arrestors are resources, which primarily consist of voltage-dependent resistors and/or spark gaps. Both elements can be switched in series or in parallel or used individually.

Arrestors are used to protect other electrical resources and electrical systems against surge voltages.

## Arrestor measured voltage $V_c$

For arrestors without a spark gap, the measured voltage is the maximum permitted effective value of the mains voltage on the arrester terminals. The measured voltage may constantly be applied to the arrester without changing its operational characteristics.

## Back-up fuse before the arrestors

There must be a back-up fuse before the arrestors. If the upstream fuse is greater than the maximum approved back-up fuse of the arrester elements (see technical data of the device), the arrester must be protected selectively with the required value.

## Cut-off unit

The cut-off unit cuts the arrester off from the mains or the earthing system if it is overloaded, thus preventing a fire risk and also signalling the switch-off of the protection device.

## Equipotential bonding

Electrical connection, which brings the bodies of electrical resources and other conductive parts to the same or almost the same potential.

## Equipotential bonding rail (PAS)

A terminal or rail, intended to connect the protective conductor, the equipotential bonding conductor and, if necessary, the conductor for function earthing with the earthing cable and the earthers.

## Error current protection unit (RCD)

Resource for protection against electric shocks and fire protection (e.g. FI protection switches).

## Lightning protection equipotential bonding system

The lightning protection equipotential bonding is a key measure in reducing the risk of fire and explosion on the room or building to be protected. The lightning protection equipotential bonding is achieved using equipotential bonding cables or arrestors, which connect the external lightning protection system, metallic parts of the building or room, the installation, the other conductive parts and the electrical energy and telecommunications systems.

## Lightning protection system (LPS)

A lightning protection system (LPS) is considered as the entire system used to protect a room or building against the impact of a lightning strike. This includes both internal and external lightning protection.

## Lightning protection zone (LPZ)

Lightning protection zones are those areas in which the electromagnetic environment of the lightning is to be defined and mastered. At the zone transitions, all cables and metallic parts must be integrated into the equipotential bonding system.

## Lightning surge current (Iimp)

A lightning surge current (lightning current carrying capacity per path) is a standardised surge current curve of the shape 10/350  $\mu$ s. With its parameters

- Peak value
- Charge
- Specific energy

it represents the load from natural lightning currents. Type 1 lightning current arrestors (previously requirement class B) must be able to arrest such lightning currents without being destroyed.

## Line follow current quenching (If)

The follow current – also called network follow current – is the current which flows through the surge protection device after an arresting operation and is supplied by the network. The follow current is considerably different from the continuous operating current. The level of the network follow current is dependent on the feed line from the transformer to the arrester.

## Nominal current (In)

The nominal current is the maximum permitted operating current which may be run continually through the appropriately labelled connection terminals.

## Nominal discharge surge current (In)

Peak value of the current flowing through the arrester with the wave shape 8/20. It is used to classify the testing of surge arrestors of type 2 (formerly requirements Class C).

## Nominal frequency (fn)

The nominal frequency is that frequency for which a resource is measured, by which it is called and upon which other nominal parameters refer.

## Nominal voltage (Vn)

The rated voltage is the voltage value for which a resource is designed. In so doing it might be a direct voltage value or the effective value of a sine-form alternating voltage.

## Surge protection device (ÜSG)

A device intended for the limitation of transient surge voltages and arresting of surge voltages. It contains at least one non-linear construction element. In general speech, surge protection devices are also termed arrestors.

## Protection level (Up)

The protection level is the highest current voltage value on the terminals of the surge protection device before response.

## Residual voltage (Vres)

The peak voltage value, occurring via the terminals of the surge protection device during or immediately after the arresting surge current has flowed.

## Short-circuit resistance

The surge protection device must be able to conduct the short-circuit current, until it is either interrupted by the device itself or by an internal or external cut-off unit or by mains-side over-current protection (e.g. back-up fuse).

## Response time (ta)

The response time primarily characterises the response behaviour of the individual protection elements used in arrestors. Depending on the slope  $du/dt$  of the surge voltage or  $di/dt$  of the surge current, the response times may vary within specific limits.

## SPD

Surge protection device.

## Surge arrester, type 1

Arrestors, which, due to their special structure, are able to arrest lightning currents or partial lightning currents during direct strikes.

## Surge arrester, type 2

Arrestors, which are able to arrest surge voltages caused by remote or nearby strikes or switching actions.

## Surge arrester, type 3

Arrestors, used for surge protection of individual consumers or consumer groups and are employed directly on sockets.

## Surge voltage

A surge voltage is a voltage occurring briefly between conductors or between a conductor and the earth, which exceeds the highest permissible operating voltage value by a long way, but does not have the operating frequency. It can be created by storms or by earthing or short-circuits.

## Temperature range

The operating temperature specifies within which temperature limits the perfect function of the surge protection device is guaranteed.

## Transient surge voltage (TOV)

Temporary surge voltages are short-term (i.e. temporary) surge voltages, which may occur due to errors within the medium and low-voltage network.

## Transmission frequency (fg)

The transmission frequency specifies up to which frequency the insertion damping of the employed resource is less than 3 dB.

## Volume resistance per path, series resistance

The volume resistance per path specifies the ohmic resistance increase of the conductor path per wire caused by the use of the surge protection device.



## Conversion table, cable material

Conversion table, cable material

Designation	Item number	Weight approx. (kg/m)	Weight approx. (kg/100 m)	Length approx. (m/kg)
Flat conductor St/FT, 20x2.5	5019340	0.41	41	2.44
Flat conductor St/FT, 25x3	5019342	0.60	59.7	1.68
Flat conductor St/FT, 30x3	5019344	0.71	70.65	1.42
Flat conductor St/FT, 30x3.5	5019345/5019347	0.84	84	1.19
Flat conductor St/FT, 30x4	5019350	0.97	97	1.03
Flat conductor St/FT, 40x4	5019355	1.28	128	0.78
Flat conductor St/FT, 40x5	5019360	1.62	162	0.62
Flat conductor copper, 20x2.5	5021804	0.45	44.5	2.25
Flat conductor VA, 30x3.5	5018501 (V2A) 5018706 (V4A) 5018730 (V4A)	0.83	82.5	1.21
St/FT round cable, 8 mm	5021081	0.40	40	2.50
St/FT round cable, 10 mm	5021103	0.63	63	1.59
Aluminium round cable, 8 mm	5021286 5021294	0.14	13.5	7.41
Aluminium round cable, 10 mm	5021308	0.21	21	4.76
Copper round cable, 8 mm	5021480	0.45	45	2.22
Copper round cable, 10 mm	5021502	0.70	70	1.43
VA round cable, 8 mm	5021235 (V2A) 5021644 (V4A)	0.40	40	2.50
VA round cable, 10 mm	5021227 (V2A) 5021239 (V2A) 5021642 (V4A) 5021647 (V4A)	0.63	63	1.59
St/FT round cable with PVC jacket, 10 mm	5021162	0.67	67.2	1.49
Aluminium round cable with PVC jacket, 8 mm	5021332	0.20	20	5.00
Copper cable, 9 mm	5021650	0.45	44.5	2.25
Copper cable, 10.5 mm	5021654	0.59	58.6	1.71



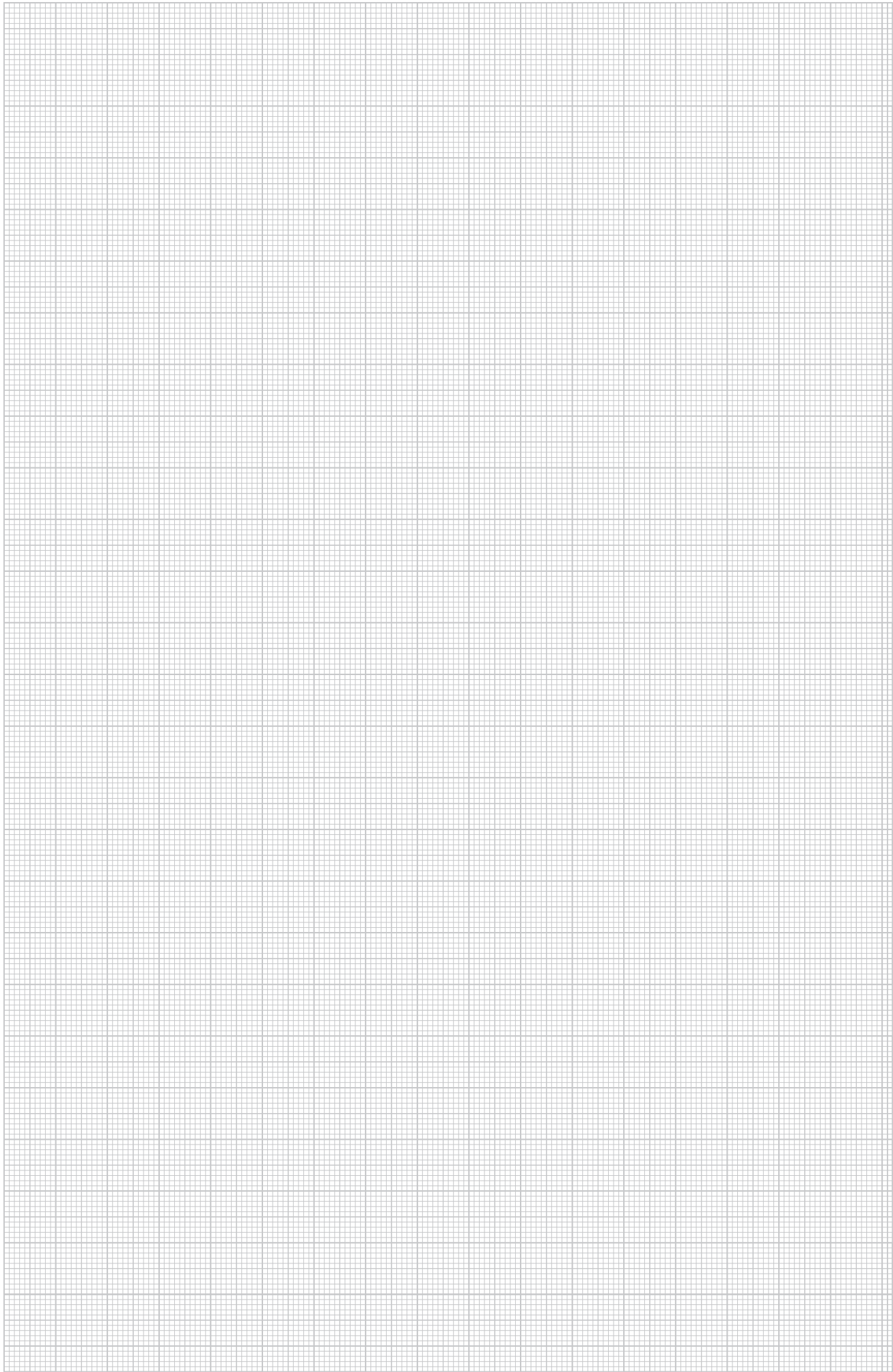















## Surge protection of data and information technology

	Surge protection	For telecommunication	236
		LSA-Plus systems	241
	Coaxial protection devices	Send-and-receive technology	245
	Surge protection	Network technology	250
		Data technology	252
		Serial interfaces	255
	MCR protection	2-pole power supply	259
		Two-core systems	265
		Multi-wire system (testable)	274
	MCR protection	Explosive areas	282



## Surge protection devices for telecommunications applications

- +Simple installation
- +Low protection level
- +High arresting capacity
- +High bandwidth
- +Wide range of uses



The data cable protection devices for telecommunications applications are available as combination protection and fine protection.

Depending on the application, from DSL through to analogue communication, the devices are used for direct intermediate switching into the data cable, meaning that they can easily be retrofitted in existing installations.

The devices differ in their connec-

tion technology and transmission cable and are thus optimised for their appropriate applications, in order to cause the lowest attenuation level possible.

# Surge protection for telecommunication systems

## Combination protection device for ISDN and DSL systems

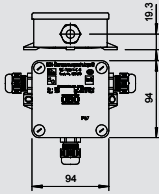

Type	Version	Connection system	Pack.	Weight	Item No.
			pcs	kg/100 pcs.	
<b>SC-TELE 4-C-G</b>	Combi protection	Terminal	1	30.000	<b>5081 68 8</b>



- Suitable for any analogue, ISDN or DSL systems
- Insulating housing to IP 54
- With screwless terminals for quick mounting
- For 2 DA systems (4 protected cores)

/pc.



## Combination protection device for ISDN

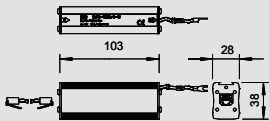

Type	Version	Connection system	Pack.	Weight	Item No.
			pcs	kg/100 pcs.	
<b>RJ11-TELE 4-C</b>	Combi protection, 4 wires	—	1	14.000	<b>5081 92 0</b>



- In aluminium housing
- Simple mounting on hat rail or on terminal
- Incl. 150 mm connection cable with RJ411 connectors
- Optimised bandwidth for telecommunications systems

/pc.

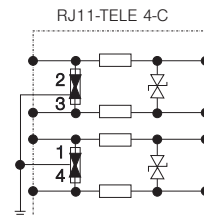
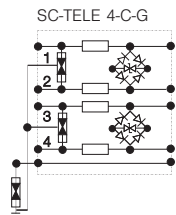

U max AC	U <sub>c</sub> AC	V	122	122
U max DC	U <sub>c</sub> DC	V	170	170
Lightning protection Zone LPZ			0-3	0-3
Impulse discharge current (10/350)	I <sub>imp</sub>	kA	5	1,5
Nominal discharge current (8/20)	I <sub>n</sub>	kA	15	7,5
Transmission frequency	f		100 MHz	12 MHz
Insertion loss	a/dB	dB	0,1 @ 144 kHz	3dB @ 12 MHz
Series resistance	R	ohm	3,3	8,2
Protection level (sym.) with In C2			≤300 V	≤300 V
Protection level (asym.) with In C2			≤500 V	≤500 V
Protection level (asym.) with 1 kV/μs C3			≤245 V	≤245 V
Degree of protection of enclosure			IP 54	IP40
Connection system			Terminal	
<b>Item No.</b>			<b>5081 68 8</b>	<b>5081 92 0</b>



# Surge protection for telecommunication systems

Surge protection device for data and information technology

LPZ 0→3 Analog TK ISDN 5

## Combination protection device for ISDN RJ11

Type	Version	Connection system	Pack.	Weight	Item No.
			pcs	kg/100 pcs.	
<b>RJ11-TELE 4-C</b>	Combi protection, 4 wires	—	1	14.000	<b>5081 92 0</b>



- In aluminium housing
- Simple mounting on hat rail or on terminal
- Incl. 150 mm connection cable with RJ411 connectors
- Optimised bandwidth for telecommunications systems

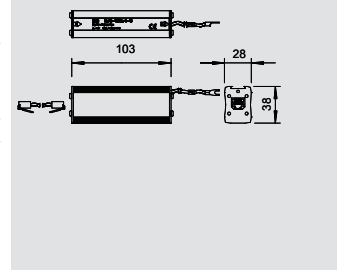

/pc.

Analog TK LPZ 1→3 ISDN 5

## Fine protection device for ISDN RJ11

Type	Version	Connection system	Pack.	Weight	Item No.
			pcs	kg/100 pcs.	
<b>RJ11-TELE 4-F</b>	Fine protection, 4 wires	—	1	14.000	<b>5081 93 9</b>



- In aluminium housing
- Simple mounting on hat rail or on terminal
- Incl. 150 mm connection cable with RJ11 connectors
- Optimised bandwidth for telecommunications systems

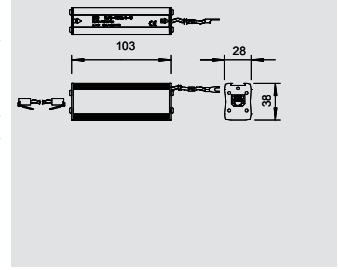

/pc.

LPZ 0→3 Analog TK ISDN 5

## Combination protection device for ISDN RJ45

Type	Version	Connection system	Pack.	Weight	Item No.
			pcs	kg/100 pcs.	
<b>RJ45-TELE 4-C</b>	Combi protection, 4 wires	RJ45	1	14.000	<b>5081 96 3</b>



- In aluminium housing
- Simple mounting on hat rail or on terminal
- Incl. 150 mm connection cable with RJ45 connectors
- Optimised bandwidth for telecommunications systems

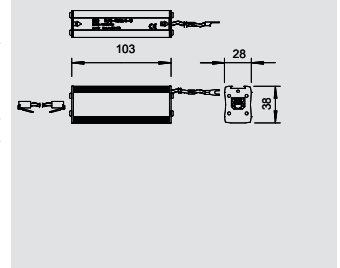

/pc.

Analog TK LPZ 1→3 ISDN 5

## Fine protection device for ISDN RJ45

Type	Version	Connection system	Pack.	Weight	Item No.
			pcs	kg/100 pcs.	
<b>RJ45-TELE 4-F</b>	Fine protection, 4 wires	RJ45	1	14.000	<b>5081 97 1</b>



- In aluminium housing
- Simple mounting on hat rail or on terminal
- Incl. 150 mm connection cable with RJ45 connectors
- Optimised bandwidth for telecommunications systems

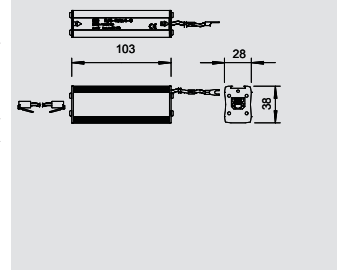

/pc.

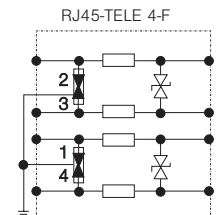
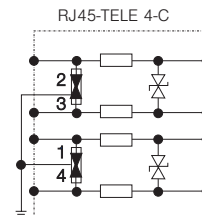
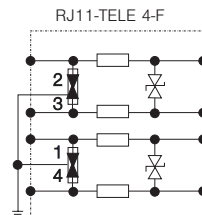
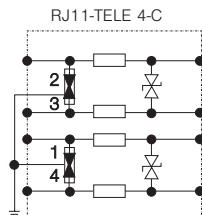

U max AC	U <sub>c</sub> AC	V	122	122	122	122
U max DC	U <sub>c</sub> DC	V	170	170	170	170
Lightning protection Zone LPZ			0→3	1→3	0→3	1→3
Impulse discharge current (10/350)	I <sub>imp</sub>	kA	1,5	-	1,5	-
Nominal discharge current (8/20)	I <sub>n</sub>	kA	7,5	7,5 / 0,5	7,5	7,5 / 0,5
Transmission frequency	f	Hz	12 MHz	18 MHz	12 MHz	18 MHz
Insertion loss	a/dB	dB	3dB @ 12 MHz	3dB @ 18 MHz	3dB @ 12 MHz	3dB @ 18 MHz
Series resistance	R	ohm	8,2	2,2	8,2	2,2
Protection level (sym.) with In C2		V	≤300 V	≤300 V	≤300 V	≤300 V
Protection level (asym.) with In C2		V	≤500 V	≤500 V	≤500 V	≤500 V
Protection level (asym.) with 1 kV/μs C3		V	≤245 V	≤245 V	≤245 V	≤245 V
Degree of protection of enclosure			IP40	IP40	IP40	IP40
Connection system					RJ45	RJ45
<b>Item No.</b>			<b>5081 92 0</b>	<b>5081 93 9</b>	<b>5081 96 3</b>	<b>5081 97 1</b>

# Surge protection for telecommunication systems

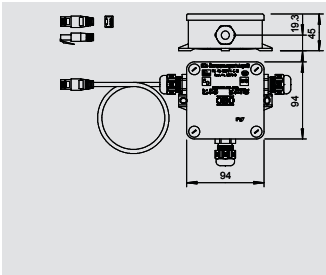

## Combination protection device for ISDN bus side



Type	Version	Connection system	Pack.	Weight	Item No.
			pcs	kg/100 pcs.	
<b>RJ45-ISDN 4-C-G</b>	Combi protection, 4 wires	RJ45	1	30.000	<b>5081 54 8</b>

/pc.

- For bus-side use on ISDN
- Insulating housing to IP 54
- With screwless terminals for quick mounting
- For 2 DA systems (4 protected cores)



Surge protection device for data and information technology

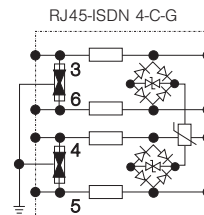

U max AC	U <sub>c</sub> AC	V	4.2
U max DC	U <sub>c</sub> DC	V	6.2
Lightning protection Zone LPZ			0-3
Impulse discharge current (10/350)	I <sub>imp</sub>	kA	2
Nominal discharge current (8/20)	I <sub>n</sub>	kA	10
Transmission frequency	f		< 6 MHz
Insertion loss	a/dB	dB	0,1 @ 144 kHz
Series resistance	R	ohm	4.7
Protection level (sym.) with In C2			≤500 V
Protection level (asym.) with In C2			≤12 V
Protection level (asym.) with 1 kV/μs C3			≤8 V
Degree of protection of enclosure			IP 54
Connection system			RJ45
<b>Item No.</b>			<b>5081 54 8</b>

## Surge protection devices for industrial telecommunications applications

- +Simple installation
- +Protection up to 10 two-core wires
- +Low protection level
- +High arresting capacity
- +High broadband in basic protection
- +Wide range of uses

Surge protection device for data and information technology

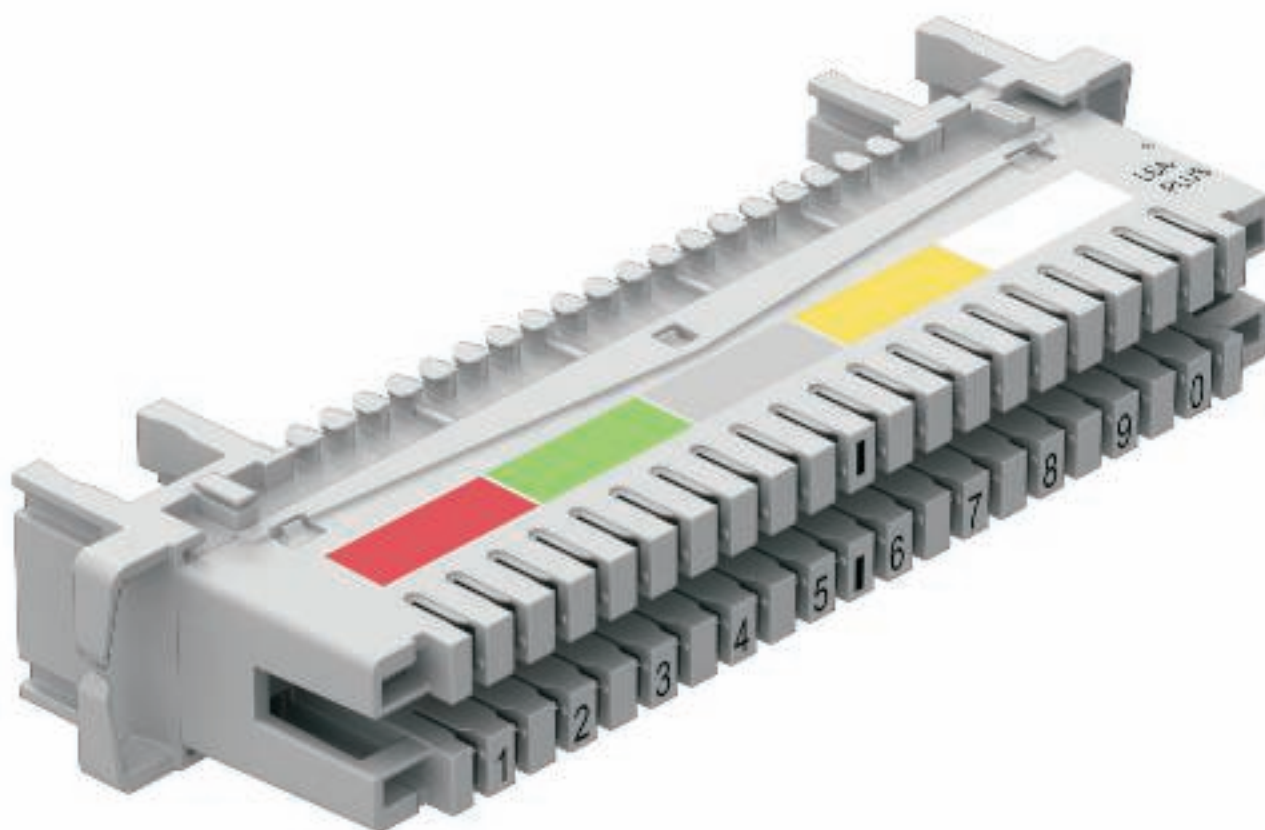

In particular with multi-wire cable systems, such as telecommunications distribution systems, the LSA surge voltage components offer rapid, adequate protection. The LSA system offers both basic protection modules and fine protection modules to protect up to ten two-core wires per connection strip. These are split up into separating and connection strips and

must be selected according to the application.

# Surge protection for LSA-Plus systems

Data cable protection for multi-wire systems (LSA-Plus)

- Available as basic and combination protection
- Protects up to 10 two-cores
- Low protection level
- Bandwidth-optimised for secure transmission
- Quick mounting on hat rail or wall mounting



Application: Telecommunications switchboards, TC extensions

LSA-Plus technology / LSA connection strip		Pack.	Weight	Item No.
Type	Colour	pcs	kg/100 pcs.	
LSA-A-LEI	Grey	1	5.100	5084 00 8

LSA-Plus technology / LSA separating strip		Pack.	Weight	Item No.
Type	Colour	pcs	kg/100 pcs.	
LSA-T-LEI	White	1	5.400	5084 01 2

LSA-Plus technology / LSA earthing strip		Pack.	Weight	Item No.
Type	Colour	pcs	kg/100 pcs.	
LSA-E-LEI	Red	1	6.500	5084 01 6

LSA-Plus technology / LSA basic protection		Pack.	Weight	Item No.
Type	Max. continuous operating voltage V	pcs	kg/100 pcs.	
LSA-B-MAG	180	1	8.600	5084 02 0

Surge protection device for data and information technology

02\_TBS\_Masterkatalog\_Länder\_2012 / en / 29/05/2012 (LLEExport\_014333) / 29/05/2012

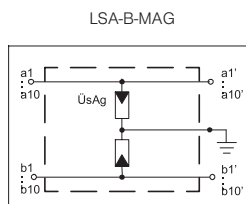

Max. continuous operating voltage	$U_c$	V	180
Lightning protection Zone LPZ			0-2
Impulse discharge current (10/350)	$I_{imp}$	kA	1
Nominal discharge current (8/20)	$I_n$	kA	5
Maximum discharge current	$I_{max}$	kA	10
Voltage protection level	$U_p$	kV	<0,700
Temperature range	$\vartheta$	°C	-40 - +80
<b>Item No.</b>			<b>5084 02 0</b>

# Surge protection for LSA-Plus systems



Data cable protection for multi-wire systems (LSA-Plus)

- Available as basic and combination protection
- Protects up to 10 two-cores
- Low protection level
- Bandwidth-optimised for secure transmission
- Quick mounting on hat rail or wall mounting

Application: Telecommunications switchboards, TC extensions

## LSA-Plus technology/LSA basic and fine protection



Type	Max. continuous operating voltage V	Pack. pcs	Weight kg/100 pcs.	Item No.
<b>LSA-BF-180</b>	180	1	0.500	<b>5084 02 4</b>

/pc.

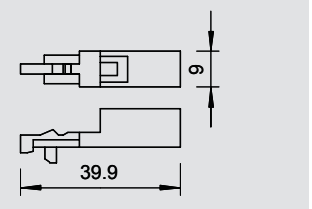

## LSA-Plus technology/LSA basic and fine protection



Type	Max. continuous operating voltage V	Pack. pcs	Weight kg/100 pcs.	Item No.
<b>LSA-BF-24</b>	24	1	0.500	<b>5084 02 8</b>

/pc.

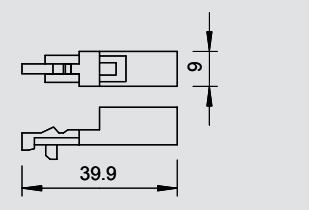

## LSA-Plus technology / LSA earthing rail for LSA-BF



Type	Pack. pcs	Weight kg/100 pcs.	Item No.
<b>LSA-E</b>	1	1.000	<b>5084 03 2</b>

/pc.

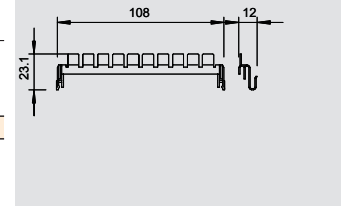

## LSA-Plus technology / LSA installation trough



Type	Pack. pcs	Weight kg/100 pcs.	Item No.
<b>LSA-M</b>	1	7.800	<b>5084 03 6</b>

/pc.

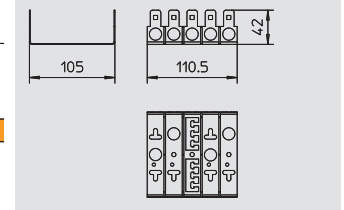

St Steel

LSA-BF-180

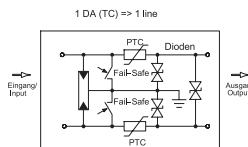

LSA-BF-24

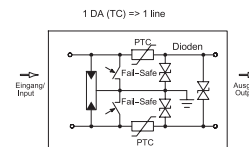

Max. continuous operating voltage	$U_c$	V	180	24
Lightning protection Zone LPZ			0-3	0-3
Impulse discharge current (10/350)	$I_{imp}$	kA	0,5	0,5
Nominal discharge current (8/20)	$I_n$	kA	2.5	2.5
Maximum discharge current	$I_{max}$	kA	5	5
Rated current	$I_L$	A	0.12	0.09
Voltage protection level	$U_p$	kV	< 300	< 0,05
Temperature range	$\vartheta$	°C	-40 - +80	-40 - +80
<b>Item No.</b>			<b>5084 02 4</b>	<b>5084 02 8</b>





# Surge protection for LSA-Plus systems

## Data cable protection for multi-wire systems (LSA-Plus)

- Available as basic and combination protection
- Protects up to 10 two-cores
- Low protection level
- Bandwidth-optimised for secure transmission
- Quick mounting on hat rail or wall mounting



Application: Telecommunications switchboards, TC extensions

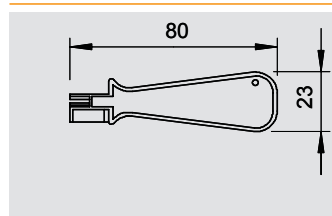

### LSA-Plus technology / LSA simple tool

Type	Pack.	Weight	Item No.
	pcs	kg/100 pcs.	
<b>LSA-TOOL</b>	1	0.600	<b>5084 04 0</b>

/pc.

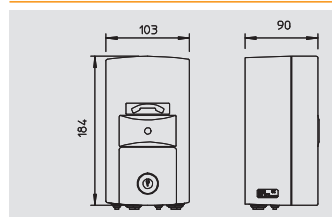

### LSA-Plus technology / protective housing

Type	Colour	Pack.	Weight	Item No.
		pcs	kg/100 pcs.	
<b>LSA-G</b>	Light grey	1	57.500	<b>5084 04 8</b>

**PA** Polyamide /pc.



Surge protection device for data and information technology





## Surge protection for high frequency applications: the plus of the DS family

- +Coaxial protection devices
- +Optimum protection for sensitive systems
- +Low insertion attenuation and low return attenuation at different wave resistances
- +High bandwidth



The coaxial protection devices of type DS offer optimum protection of sensitive systems, based on coaxial plug connections. The low insertion attenuation and low return attenuation at different wave resistances offer ideal protection for any application. In accordance with their structure, the protection devices are switched into the application in series, and are connected to the local equipotential bonding. The direct shield earthing

avoids reducing of the shield performance.

# Coaxial protection devices for transmission and reception technology

Data cable protection devices for transmission and reception technology

- Different connection systems available
- Low protection level at high current load
- Low reflection behaviour
- Bandwidth-optimised for secure transmission
- Available in 50 Ω and 75 Ω technology

Application: BOS radio, SAT and TV systems, mobile radio

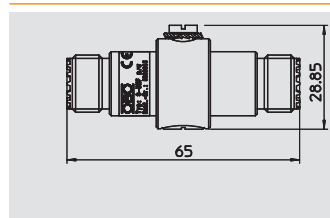

## Coaxial protection devices for S-UHF connection: male/female

Type	Connection system	Bandwidth	Pack. pcs	Weight kg/100 pcs.	Item No.
S-UHF M/W	UHF connector	0 - 1,3 GHz	1	7.000	5093 02 3

/pc.

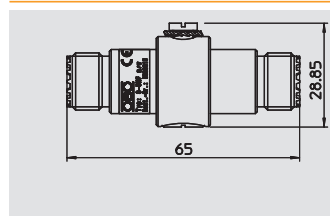

## Coaxial protection devices for S-UHF connection: female/female

Type	Connection system	Bandwidth	Pack. pcs	Weight kg/100 pcs.	Item No.
S-UHF W/W	UHF connector	0 - 1,3 GHz	1	6.500	5093 01 5

/pc.

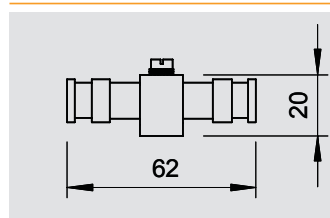

## Coaxial protection device for BNC connection: male/female

Type	Connection system	Bandwidth	Pack. pcs	Weight kg/100 pcs.	Item No.
DS-BNC M/W	BNC, 50 Ohm	0 - 2,2 GHz	1	6.500	5093 25 2

/pc.

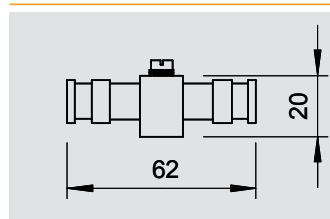

## Coaxial protection device for BNC connection: female/female

Type	Connection system	Bandwidth	Pack. pcs	Weight kg/100 pcs.	Item No.
DS-BNC W/W	BNC, 50 Ohm	0 - 2,2 GHz	1	6.000	5093 23 6

/pc.

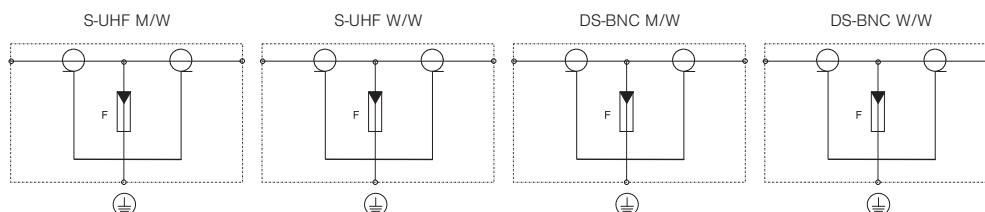

Maximum continuous operating voltage Vc/AC	V	130	130	130	130
Maximum continuous operating voltage Vc/DC	V	185	185	185	185
Degree of protection of enclosure		IP40	IP40	IP40	IP40
Lightning protection Zone LPZ		0-2	0-2	0-2	0-2
Rated current	I <sub>L</sub>	A	10	10	10
Bandwidth		0 - 1,3 GHz	0 - 1,3 GHz	0 - 2,2 GHz	0 - 2,2 GHz
Connection system		UHF connector	UHF connector	BNC, 50 Ohm	BNC, 50 Ohm
Wave resistance	Z <sub>0</sub>	Ω	50	50	50
Insertion loss	a/dB	dB	0,2 dB @ 1,3GHz	0,2 dB @ 1,3GHz	0,95 dB @ 2,2 GHz
Reflux loss		dB	14 dB @ 1,3 GHz	14 dB @ 1,3 GHz	14 dB @ 2,2 GHz
Voltage protection level line-earth	V	800	800	800	800
Total Impulse durability (10/350)	kA	D1: 5	D1: 5	D1: 5	D1: 5
Total Impulse durability (8/20)	kA	10	10	10	10
Temperature range	θ	°C	-40 - +80	-40 - +80	-40 - +80
Testing standard		IEC 61643-21	IEC 61643-21	IEC 61643-21	IEC 61643-21
<b>Item No.</b>		<b>5093 02 3</b>	<b>5093 01 5</b>	<b>5093 25 2</b>	<b>5093 23 6</b>

Surge protection device for data and information technology



02\_TBS\_Masterkatalog\_Länder\_2012 / en / 29/05/2012 (LLEExport\_01433) / 29/05/2012

# Coaxial protection devices for transmission and reception technology



Data cable protection devices for transmission and reception technology

- Different connection systems available
  - Low protection level at high current load
  - Low reflection behaviour
  - Bandwidth-optimised for secure transmission
  - Available in 50 Ω and 75 Ω technology
- Application: BOS radio, SAT and TV systems, mobile radio

## Coaxial protection device for BNC connection: male/male



Type	Connection system	Bandwidth	Pack. pcs	Weight kg/100 pcs.	Item No.
<b>DS-BNC M/M</b>	BNC, 50 Ohm	0 - 2,2 GHz	1	7.000	<b>5093 26 0</b>

/pc.

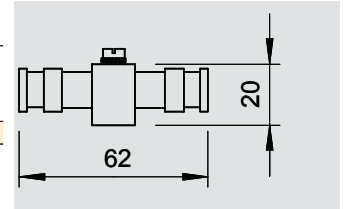

## Coaxial protection device for N connection: male/female



Type	Connection system	Bandwidth	Pack. pcs	Weight kg/100 pcs.	Item No.
<b>DS-N M/W</b>	N connector	0- 3 GHz	1	12.200	<b>5093 99 6</b>

/pc.

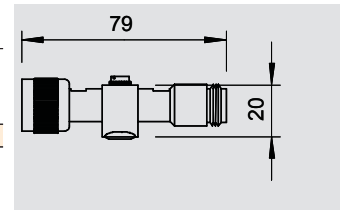

## Coaxial protection device for N connection: female/female



Type	Connection system	Bandwidth	Pack. pcs	Weight kg/100 pcs.	Item No.
<b>DS-N W/W</b>	N connector		1	12.500	<b>5093 98 8</b>

/pc.

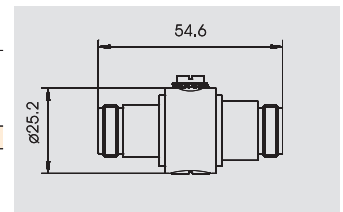

## Coaxial protection device for TNC connection: male/female



Type	Connection system	Bandwidth	Pack. pcs	Weight kg/100 pcs.	Item No.
<b>DS-TNC M/W</b>		0 - 4 GHz	1	9.000	<b>5093 27 0</b>

/pc.

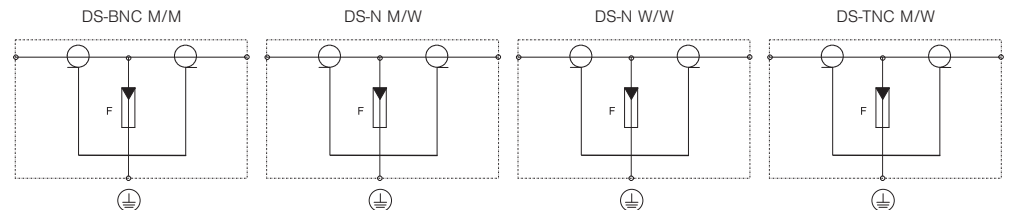
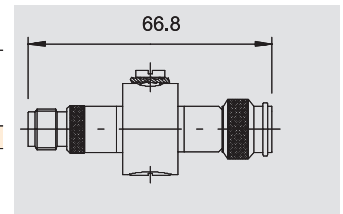

Maximum continuous operating voltage V <sub>C/AC</sub>	V	130	130	130	130
Maximum continuous operating voltage V <sub>C/DC</sub>	V	185	185	185	185
Degree of protection of enclosure		IP40	IP40	IP40	IP40
Lightning protection Zone LPZ		0-2	0-2	0-2	0-2
Rated current I <sub>L</sub>	A	10	10	10	10
Bandwidth		0 - 2,2 GHz	0- 3 GHz	0- 3 GHz	0 - 4 GHz
Connection system		BNC, 50 Ohm	N connector	N connector	
Wave resistance Z <sub>L</sub>	Ω	50	50	50	50
Insertion loss	a/dB	0,95 dB @ 2,2 GHz	0,62 dB @ 3 GHz	0,62 dB @ 3 GHz	0,5 dB @ 4 GHz
Reflux loss	dB	14 dB @ 2,2 GHz	14 dB @ 3 GHz	14 dB @ 3 GHz	14 dB @ 4 GHz
Voltage protection level line-earth	V	800	800	800	800
Total Impulse durability (10/350)	kA	D1: 5	D1: 5 kA	D1: 5 kA	D1: 5
Total Impulse durability (8/20)	kA	10	10	10	10
Temperature range	θ °C	-40 - +80	-40 - +80	-40 - +80	-40 - +80
Testing standard		IEC 61643-21	IEC 61643-21	IEC 61643-21	IEC 61643-21
<b>Item No.</b>		<b>5093 26 0</b>	<b>5093 99 6</b>	<b>5093 98 8</b>	<b>5093 27 0</b>



# Coaxial protection devices for transmission and reception technology

Data cable protection devices for transmission and reception technology

- Different connection systems available
- Low protection level at high current load
- Low reflection behaviour
- Bandwidth-optimised for secure transmission
- Available in 50 Ω and 75 Ω technology

Application: BOS radio, SAT and TV systems, mobile radio



Coaxial protection device for 7/16 connection: male/female						
Type	Connection system	Bandwidth	Pack. pcs	Weight kg/100 pcs.	Item No.	
DS-7 16 M/W	7/16 connector	0 - 3 GHz	1	35.500	5093 17 1	/pc.

Coaxial protection device for F connection: male/female						
Type	Connection system	Bandwidth	Pack. pcs	Weight kg/100 pcs.	Item No.	
DS-F M/W	SAT-F	0 - 863 MHz	1	9.000	5093 27 5	/pc.

Coaxial protection device for F connection: female/female						
Type	Connection system	Bandwidth	Pack. pcs	Weight kg/100 pcs.	Item No.	
DS-F W/W	SAT-F	0 - 863 MHz	1	9.000	5093 27 2	/pc.

Coaxial protection device for SMA connection: female/female						
Type	Connection system	Bandwidth	Pack. pcs	Weight kg/100 pcs.	Item No.	
DS-SMA W/W	—	0 - 3,7 GHz	1	7.500	5093 27 7	/pc.

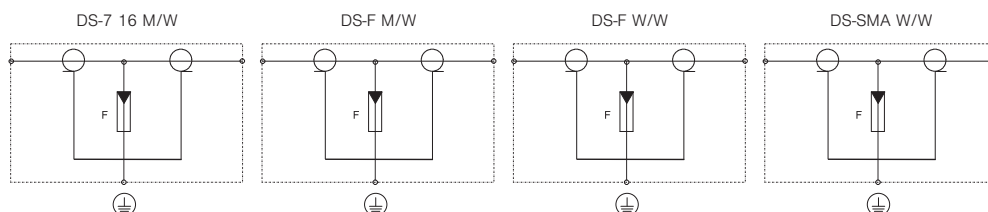

Maximum continuous operating voltage Vc/AC	V	130	130	130	130
Maximum continuous operating voltage Vc/DC	V	185	185	185	185
Degree of protection of enclosure		IP40	IP40	IP40	IP40
Lightning protection Zone LPZ		0→2	0→2	0→2	0→2
Rated current	I <sub>L</sub> A	10	10	10	10
Bandwidth		0 - 3 GHz	0 - 863 MHz	0 - 863 MHz	0 - 3,7 GHz
Connection system		7/16 connector	SAT-F	SAT-F	
Wave resistance	Z <sub>w</sub> Ω	50	75	75	50
Insertion loss	a/dB	0,95 dB @ 3 GHz	0,18 dB @ 863 MHz	0,18 dB @ 863 MHz	0,2 dB @ 3,7 GHz
Reflux loss		14 dB @ 3 GHz	14 dB @ 863 GHz	14 dB @ 863 GHz	14 dB @ 3,7 GHz
Voltage protection level line-earth	V	800	800	800	800
Total Impulse durability (10/350)	kA	D1: 5	D1: 5	D1: 5	D1: 5
Total Impulse durability (8/20)	kA	10	10	10	10
Temperature range	θ °C	-40 - +80	-40 - +80	-40 - +80	-40 - +80
Testing standard		IEC 61643-21	IEC 61643-21	IEC 61643-21	IEC 61643-21
<b>Item No.</b>		<b>5093 17 1</b>	<b>5093 27 5</b>	<b>5093 27 2</b>	<b>5093 27 7</b>

Always indicate the item number when ordering.

# Coaxial protection devices for transmission and reception technology



Data cable protection devices for transmission and reception technology

- Different connection systems available
- Low protection level at high current load
- Low reflection behaviour
- Bandwidth-optimised for secure transmission
- Available in 50 Ω and 75 Ω technology

Application: BOS radio, SAT and TV systems, mobile radio



## Coaxial protection device for SAT and cable multiswitch

Type	Connection system	transmission frequency f	Pack. pcs	Weight kg/100 pcs.	Item No.
<b>TV 4+1</b>	SAT-F	0,5 - 2,8 GHz	1	37.000	<b>5083 40 0</b>

/pc.

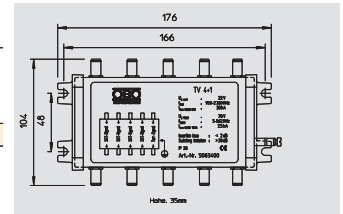

Surge protection device for data and information technology

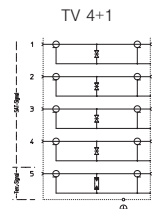

Maximum continuous voltage V <sub>c</sub>   SAT inputs	U <sub>c</sub>	V	22
Maximum continuous voltage V <sub>c</sub>   terrestrial input	U <sub>c</sub>	V	70
Lightning protection Zone LPZ			1→3
Nominal discharge current   SAT inputs	I <sub>n</sub>	A	300
Lightning impulse current   terrestrial input	I <sub>imp</sub>	kA	1
Transmission frequency	f		0,5 - 2,8 GHz
Reflux loss		dB	14 at 2.7 GHz
Protection level   terrestrial input with C2 (0.25 kA 8/20)		V	≤500
Protection level   SAT inputs with C2 (0.25 kA 8/20)	U <sub>p</sub>	V	≤45
Connection system			SAT-F
Temperature range	θ	°C	-40 - +80
<b>Item No.</b>			<b>5083 40 0</b>

## Surge protection devices for network technology: the plus of the Net Defender

- +Connectable protection device
- +High-performance surge protection
- +Usable in the "Channel Link" up to 10 GBit
- +Supports Power over Ethernet to 1 A
- +Testing protocol available



The "Net Defender" permits the use of Power over Ethernet with nominal currents of up to 1 A and optimised surge protection in the channel up to 10 GBit/s. This corresponds to a Channel Performance according to ISO/IEC 11801 Amd. 2 of Class EA or CAT 6A to TIA/ANSI. Of course, reverse compatibility is also guaranteed. To ensure easy installation, the "Net Defender" can be snapped directly onto the hat rail and uses it to create the necessary equipotential bonding. Alternatively, terminal protection using a separately connectable earthing line is possible.



# Surge protection for network technology

PoE LPZ 1→3 Cat 6<sub>A</sub> Class E<sub>A</sub>



## Surge protection for high-speed networks up to 10 GBit (Class EA/CAT6A)

Type	Version	Connection system	Pack. pcs	Weight kg/100 pcs.	Item No.
ND-CAT6A/EA	8-pole	RJ45	1	16.600	5081 80 0

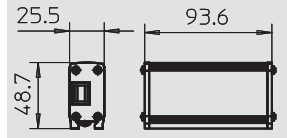

- High-quality RJ-45 sockets
- Support for Power over Ethernet + to 1 A
- Tested transmission quality in networks up to 10 GBit (Class EA) and CAT6A
- Rapid installation through connectable design

/pc.

LPZ 1→3 Cat 5



## Fine protection for Ethernet networks (Class D/CAT 5)

Type	Version	Connection system	Pack. pcs	Weight kg/100 pcs.	Item No.
RJ45 S-ATM 8-F	Fine protection	RJ45	1	14.000	5081 79 3

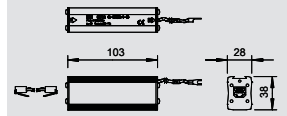

- Usable in networks of Class D or CAT 5
- Can be locked onto hat profile rails or mounted directly at the terminal
- Simple installation using RJ45 connection technology
- Optimised transmission properties

/pc.

LPZ 0→3



## Combination arrestor for 10Base2-/10Base5 networks

Type	Version	Connection system	Pack. pcs	Weight kg/100 pcs.	Item No.
KOAX B-E2 MF-C	Combined protection	TAE-N	1	10.300	5082 41 2

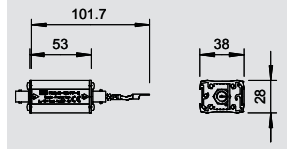

- In aluminium housing
- BNC connector for Cheapernet, 10BASE2
- Simple mounting with adapter connector
- Two-stage protection circuit

/pc.

LPZ 0→3



## Fine protection for 10Base2-/10Base5 networks

Type	Version	Connection system	Pack. pcs	Weight kg/100 pcs.	Item No.
KOAX B-E2 MF-F	Fine protection	TAE-N	1	9.800	5082 42 0

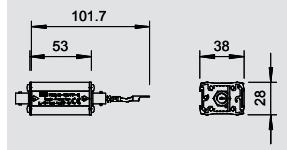

- In aluminium housing
- BNC connector for Cheapernet, 10BASE2
- Simple mounting with adapter connector
- Two-stage protection circuit

/pc.

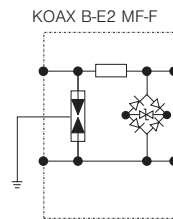
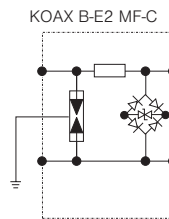
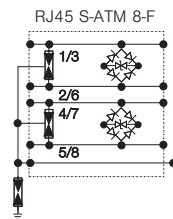
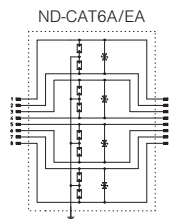

U max AC	U <sub>c</sub> AC	V	41	4.2	4.2	4.2
U max DC	U <sub>c</sub> DC	V	58	6	6.2	6.2
Lightning protection Zone LPZ			1→3	1→3	0→3	1→3
Channel performance ISO/IEC			Class EA	Class D	Class D	Class D
Channel performance Ansi/EA			58 B	6 B	6,2 B	6,2 B
Total impulse durability into C2 (8/20)		kA	7	5	10	10
Impulse durability int C2 (wire-wire)		kA	0.15	0.25	0.5	0.5
Voltage protection level line-earth		V	<700	< 800	< 500	< 500
Voltage protection level line-line		V	<120	< 12	< 12	< 12
Rated current	I <sub>L</sub>	A	1		0.2	0.2
Serial impedance per wire	f <sub>0</sub>	Ω			5	5
Transmission frequency	f	Hz	500 MHz	> 155 MHz	< 113 MHz	< 200 MHz
Degree of protection of enclosure			IP10	IP40	IP40	IP40
Connection system			RJ45	RJ45	TAE-N	TAE-N
Testing standard			IEC 61643-21	IEC 61643-21	IEC 61643-21	IEC 61643-21
<b>Item No.</b>			<b>5081 80 0</b>	<b>5081 79 3</b>	<b>5082 41 2</b>	<b>5082 42 0</b>





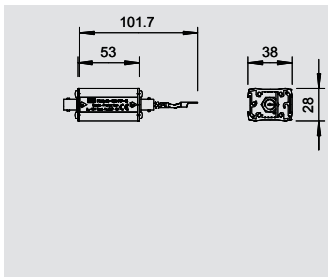

## Data cable protection device for coaxial TV / camera systems



Type	Version	Connection system	Pack.	Weight	Item No.
			pcs	kg/100 pcs.	
<b>KoaxB-E2 FF-F</b>	Fine protection	BNC, 50 Ohm	1	14.400	<b>5082 42 2</b>

/pc.

- Usable in CCTV and diverse TV systems
- Optimised transmission properties
- Can be locked onto hat profile rail
- Simple connection technology

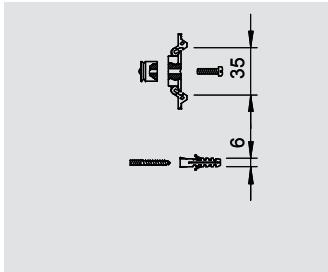

## Fastening set for hat profile rail



Type	Version	Pack.	Weight	Item No.
		pcs	kg/100 pcs.	
<b>DLS-BS</b>	For mounting: • Coax B-E2/... • Coax N-E5/... • RJ 11-Tele/4... • RJ 45 S-...	1	5.000	<b>5082 38 2</b>

/pc.

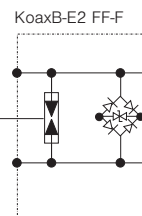

U max AC	U <sub>c</sub> AC	V	4.2
U max DC	U <sub>c</sub> DC	V	6.2
Lightning protection Zone LPZ			1-3
Nominal discharge current (8/20)	I <sub>n</sub>	kA	10 / 0,5
Voltage protection level line-earth		V	< 500
Voltage protection level line-line		V	< 12
Insertion loss	a/dB	dB	14 @ 60 MHz
Serial impedance per wire	f <sub>0</sub>	Ω	0
Degree of protection of enclosure			IP40
Connection system			BNC, 50 Ohm
Testing standard			IEC 61643-21
<b>Item No.</b>			<b>5082 42 2</b>



# Surge protection for data technology



Data cable protection device for information technology systems

- In aluminium housing
- RJ 45 Connector
- Incl. 150 mm connecting cable with RJ 45 connectors
- Simple mounting using adapter plug
- Two-stage protective circuit

Application: Twisted pair, control circuits, communication cables

## Basic protection for 4-wire information technology systems with RJ45



Type	Version	Connection system	Pack. pcs	Weight kg/100 pcs.	Item No.
<b>RJ45 S-E100 4-B</b>	Basic protection, 4 wires	RJ45	1	14.000	<b>5081 72 6</b>

/pc.

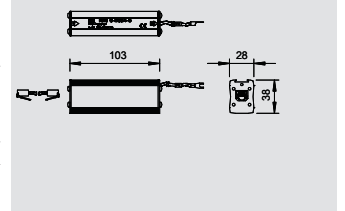

## Combination arrestor for 4-wire information technology systems with RJ45



Type	Version	Connection system	Pack. pcs	Weight kg/100 pcs.	Item No.
<b>RJ45 S-E100 4-C</b>	Combined protection, 4 wires	RJ45	1	14.000	<b>5081 73 4</b>

/pc.

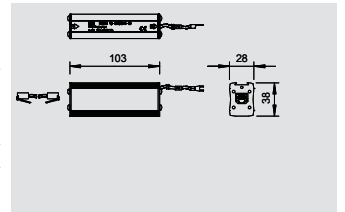

## Fine protection for 4-wire information technology systems with RJ45



Type	Version	Connection system	Pack. pcs	Weight kg/100 pcs.	Item No.
<b>RJ45 S-E100 4-F</b>	Fine protection, 4 wires	RJ45	1	14.000	<b>5081 74 2</b>

/pc.

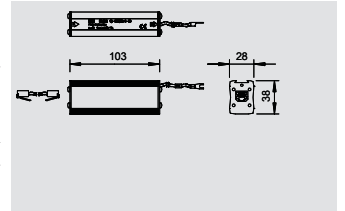

RJ45 S-E100 4-B

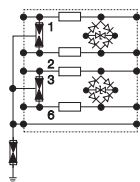

RJ45 S-E100 4-C

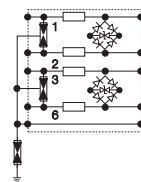

RJ45 S-E100 4-F

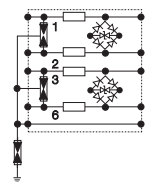

U max AC	U <sub>c</sub> AC	V	122	4.2	4.2
U max DC	U <sub>c</sub> DC	V	170	6.2	6.2
Lightning protection Zone LPZ			0→2	0→2	2→3
Impulse discharge current (10/350)	I <sub>imp</sub>	kA	1,5	1,5	-
Nominal discharge current (8/20)	I <sub>n</sub>	kA	7,5	7,5	7,5 / 0,5
Transmission frequency	f		155 MHz	70 MHz	100 MHz
Insertion loss	a/dB	dB	0,3 @ 100 MHz	5 @ 100 MHz	3 @ 100 MHz
Series resistance	R	ohm	-	4,7	-
Protection level (sym.) with In C2			≤500 V	≤12 V	≤12 V
Protection level (asym.) with In C2			≤800 V	≤800 V	≤800 V
Protection level (asym.) with 1 kV/μs C3			≤500 V	≤8 V	≤8 V
Degree of protection of enclosure			IP 40	IP 40	IP 40
Connection system			RJ45	RJ45	RJ45
<b>Item No.</b>			<b>5081 72 6</b>	<b>5081 73 4</b>	<b>5081 74 2</b>



Data cable protection device for information technology systems



- In aluminium housing
- RJ 45 Connector
- Incl. 150 mm connecting cable with RJ 45 connectors
- Simple mounting using adapter plug
- Two-stage protective circuit

Application: Twisted pair, control circuits, communication cables

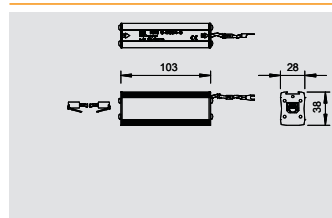

## Fine protection for 4-wire information technology systems RJ45

Type	Version	Connection system	Pack.	Weight	Item No.
			pcs	kg/100 pcs.	
<b>RJ45S-V24T 4-F</b>	Fine protection, 4 wires	RJ45	1	14.000	<b>5081 64 5</b>

/pc.

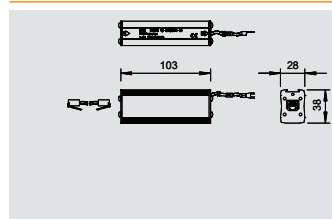

## Fine protection for 8-wire information technology systems RJ45

Type	Version	Connection system	Pack.	Weight	Item No.
			pcs	kg/100 pcs.	
<b>RJ45S-V24T 8-F</b>	Fine protection, 8 wires	RJ45	1	14.000	<b>5081 64 7</b>

/pc.



RJ45S-V24T 4-F

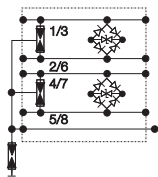

RJ45S-V24T 8-F

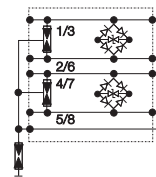

U max AC	U <sub>c</sub> AC	V	10	10
U max DC	U <sub>c</sub> DC	V	15	15
Lightning protection Zone LPZ			2→3	2→3
Nominal discharge current (8/20)	I <sub>n</sub>	kA	7,5 / 0,25	7,5 / 0,15
Protection level (sym.) with In C2			≤30 V	≤30 V
Protection level (asym.) with In C2			≤800 V	≤800 V
Protection level (asym.) with 1 kV/μs C3			≤25 V	≤25 V
Degree of protection of enclosure			IP40	IP40
Connection system			RJ45	RJ45
<b>Item No.</b>			<b>5081 64 5</b>	<b>5081 64 7</b>



## Product family, surge protection for serial interfaces

- + Connectable protection device
- + High-performance surge protection
- + Various interfaces available
- + Low protection level

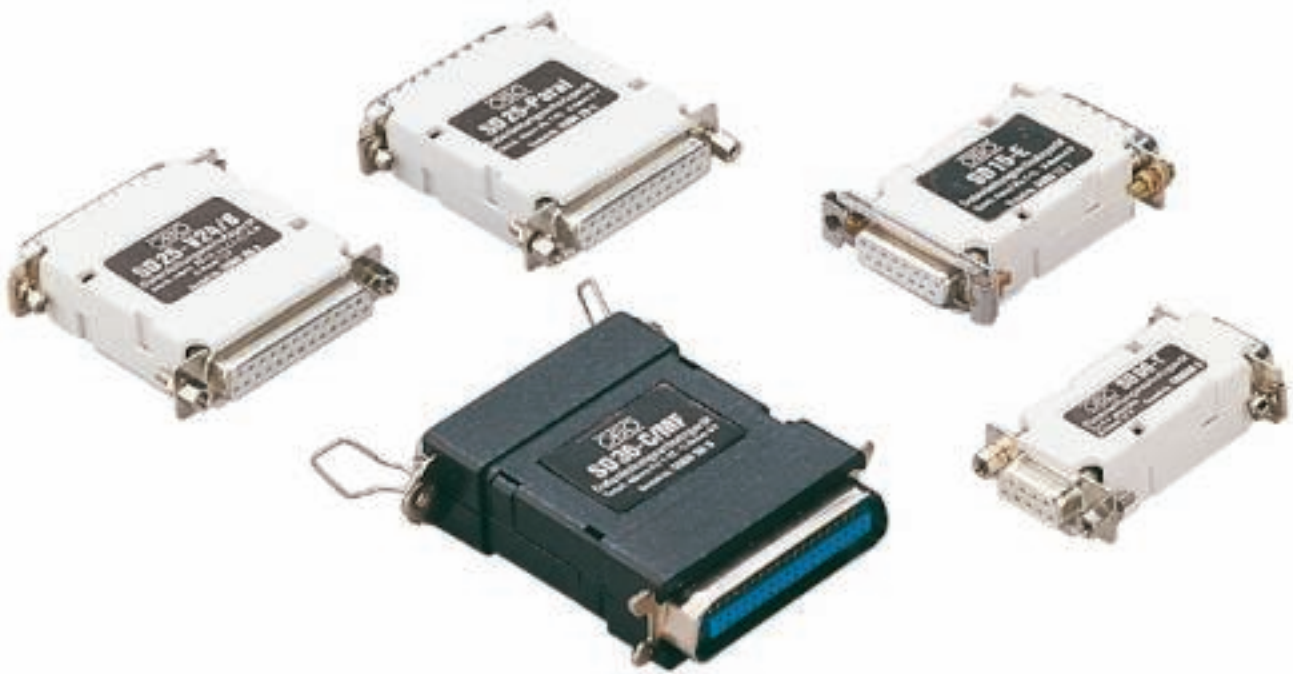

Serial interfaces are regularly found in industrial applications. Whether RS-232 or RS-422, depending on the connection system, OBO Bettermann can offer easy to install surge protection. Depending on the interface, these components are switched into the appropriate system in series, thus offering protection against the coupling of surge voltages between data cables.



Data cable protection devices, serial interface



- Different connection systems available
- Low protection level

Application: PLC, alarm systems, controllers

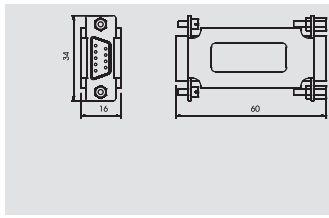

### Fine protection for 9-pin RS232 interface

Type	Max. continuous operating voltage V	Version	Pack. pcs	Weight kg/100 pcs.	Item No.
<b>SD09-V24 9</b>	18	SUB-D-9; V24 RS232	1	6.000	<b>5080 05 3</b>

/pc.

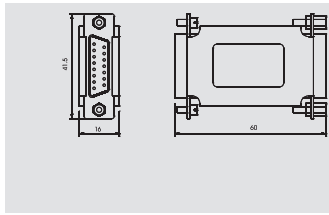

### Fine protection for 15-pin RS232 interface

Type	Max. continuous operating voltage V	Version	Pack. pcs	Weight kg/100 pcs.	Item No.
<b>SD15-V24 15</b>	18	SUB-D-15; V24 RS232	1	7.000	<b>5080 15 0</b>

/pc.

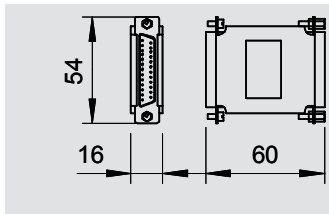

### Fine protection for 25-pin RS232 interface

Type	Max. continuous operating voltage V	Version	Pack. pcs	Weight kg/100 pcs.	Item No.
<b>SD25-V24 25</b>	18	SUB-D-25; V24 RS232	1	8.000	<b>5080 27 4</b>

/pc.

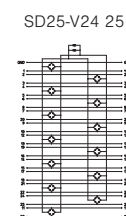
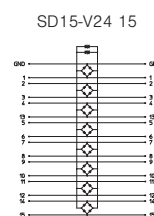
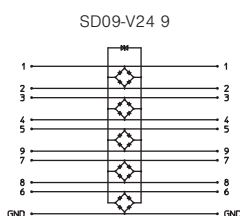

	SD09-V24 9	SD15-V24 15	SD25-V24 25
Max. continuous operating voltage	18	18	18
Lightning protection Zone LPZ	2-3	2-3	2-3
Nominal discharge current (8/20)	0.34	0.34	0.34
Protection level (sym.) with In C2	≤50 V	≤50 V	≤50 V
Protection level (asym.) with In C2	≤50 V	≤50 V	≤50 V
Protection level (asym.) with 1 kV/μs C3	≤25 V	≤25 V	≤25 V
Connection system	D-Sub 9 pole	D-Sub 15 pole	D-Sub 25 pole
<b>Item No.</b>	<b>5080 05 3</b>	<b>5080 15 0</b>	<b>5080 27 4</b>



# Surge protection for serial interfaces



Data cable protection devices, serial interface

- Different connection systems available
- Low protection level

Application: PLC, alarm systems, controllers



## Fine protection for 9-pin RS485 interface

Type	Max. continuous operating voltage V	Version	Pack. pcs	Weight kg/100 pcs.	Item No.
<b>SD09-V11 9</b>	7.5	SUB-D-9; V11 RS485	1	6.000	<b>5080 06 1</b>

/pc.

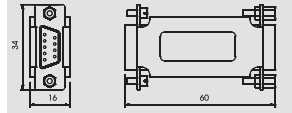

## Fine protection for 25-pin RS485 interface

Type	Max. continuous operating voltage V	Version	Pack. pcs	Weight kg/100 pcs.	Item No.
<b>SD25-V11 25</b>	7.5	SUB-D-25; V11 RS485	1	8.000	<b>5080 28 2</b>

/pc.

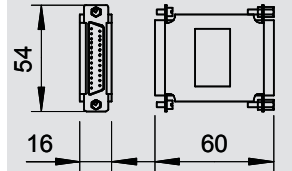

Surge protection device for data and information technology

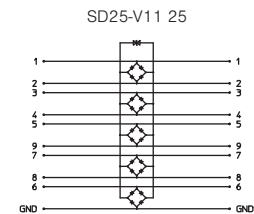
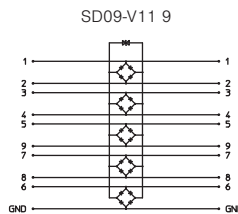

Max. continuous operating voltage	$U_c$	V	7.5	7.5
Lightning protection Zone LPZ			2-3	2-3
Nominal discharge current (8/20)	$I_n$	kA	0.75	0.75
Protection level (sym.) with In C2			≤100 V	≤100 V
Protection level (asym.) with In C2			≤100 V	≤100 V
Protection level (asym.) with 1 kV/μs C3			≤10 V	≤10 V
Connection system			D-Sub 9 pole	D-Sub 25 pole
<b>Item No.</b>			<b>5080 06 1</b>	<b>5080 28 2</b>

Data cable protection device, serial interface



- Screwless terminal connections
- Direct installation in the cable compartment
- Adhesive Velcro connection included

Application: direction installation in the cable compartment

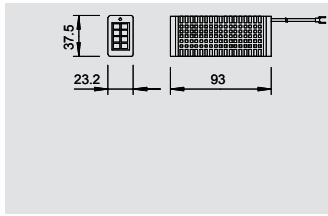

### Fine protection for RS232 with screwless terminals

Type	Max. continuous operating voltage V	Version	Connection system	Pack. pcs	Weight kg/100 pcs.	Item No.
<b>ASP-V24T 4</b>	18	4 pole, V24	Terminal	1	7.500	<b>5083 06 0</b>



/pc.

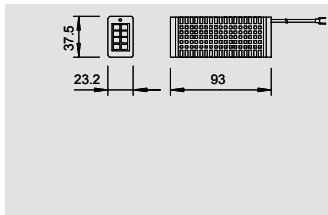

### Fine protection for RS485 with screwless terminals

Type	Max. continuous operating voltage V	Version	Connection system	Pack. pcs	Weight kg/100 pcs.	Item No.
<b>ASP-V11EI 4</b>	7.5	4 pole, V11	Terminal	1	7.500	<b>5083 08 7</b>



/pc.

ASP-V24T 4

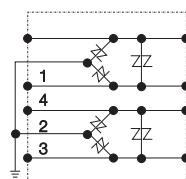

ASP-V11EI 4

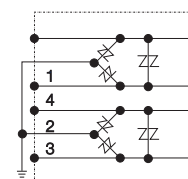

Max. continuous operating voltage	$U_c$	V	18	7.5
Lightning protection Zone LPZ			2→3	2→3
Nominal discharge current (8/20)	$I_n$	kA	0.34	0.75
Protection level (sym.) with In C2			≤65 V	≤110 V
Protection level (asym.) with In C2			≤55 V	≤120 V
Protection level (asym.) with 1 kV/μs C3			≤25 V	≤10 V
Connection system			Terminal	Terminal
<b>Item No.</b>			<b>5083 06 0</b>	<b>5083 08 7</b>





## Fine power protection, series installation: the plus of the VF family

- +High arresting capacity**
- +Low protection level**
- +Usable in AC/DC applications**
- +Simple mounting using screwless terminals**
- +UL-listed**



The lightning barriers of type VF are fine protection devices, used for single-phase energy technology systems. Besides the low protection level, these devices also have a visual display, which will indicate defective surge protection. If required, remote signalling is also available using a changeover contact and an NC contact.



# MCR protection for 2-pin for power supply

Surge protection device, fine protection type 3 for distributor installation

- Suitable for DC and AC voltage systems
- With visual function display
- With installation-friendly, screwless connection terminals
- In a space-saving 17.5 mm grid
- Y connection

Application: Universal use on 35 mm U-rail in every normal commercially available distribution housing.

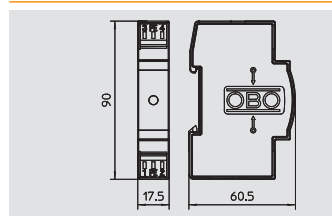

## MCR protection for 2-pin for power supply, 12 V

Type	Version	U max AC V	U max DC V	Pack. pcs	Weight kg/100 pcs.	Item No.
<b>VF12-AC DC</b>	12 V version	13.5	18	1	9.000	<b>5097 45 3</b>

/pc.

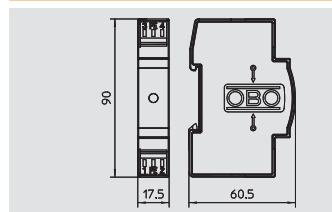

## MCR protection for 2-pin for power supply, 24 V

Type	Version	U max AC V	U max DC V	Pack. pcs	Weight kg/100 pcs.	Item No.
<b>VF24-AC/DC</b>	24 V version	34	46	1	8.000	<b>5097 60 7</b>

/pc.

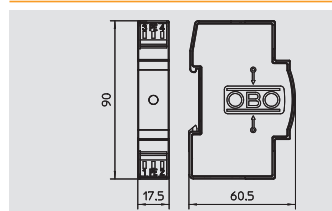

## MCR protection for 2-pin for power supply, 48 V

Type	Version	U max AC V	U max DC V	Pack. pcs	Weight kg/100 pcs.	Item No.
<b>VF48-AC/DC</b>	48 V version	60	80	1	8.000	<b>5097 61 5</b>

/pc.

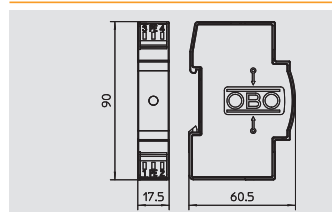

## MCR protection for 2-pin for power supply, 60 V

Type	Version	U max AC V	U max DC V	Pack. pcs	Weight kg/100 pcs.	Item No.
<b>VF60-AC/DC</b>	60 V version	80	110	1	8.000	<b>5097 62 3</b>

/pc.

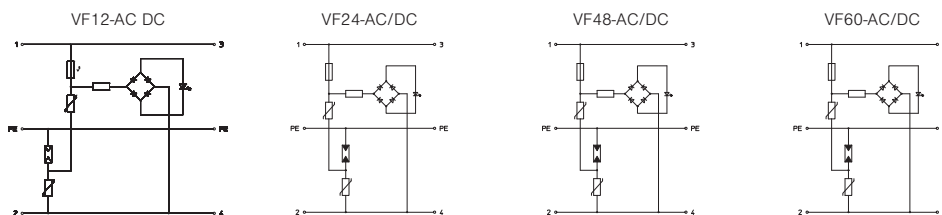

			VF12-AC DC	VF24-AC/DC	VF48-AC/DC	VF60-AC/DC
U max AC	U <sub>c</sub> AC	V	13.5	34	60	80
U max DC	U <sub>c</sub> DC	V	18	46	80	110
SPD to EN 61643-11			Type 3	Type 3	Type 3	Type 3
SPD to IEC 61643-11			class III	class III	class III	class III
Lightning protection Zone LPZ			2→3	2→3	2→3	2→3
Nominal discharge current (8/20)	I <sub>n</sub>	kA	0.7	0.7	0.7	0.7
Rated current	I <sub>L</sub>	A	20	20	20	20
Voltage protection level line-line		V	<110	<130	<220	<280
Voltage protection level line-earth		V	<1200	<1200	<1200	<1200
Response time	t <sub>A</sub>	ns	< 25	< 25	< 25	< 25
Temperature range	θ	°C	-40 - +80	-40 - +80	-40 - +80	-40 - +80
Degree of protection of enclosure			IP 20	IP 20	IP 20	IP 20
Division unit TE (17.5 mm)			1	1	1	1
Connection cross-section, rigid		mm <sup>2</sup>	0,14 - 2,5	0,14 - 2,5	0,14 - 2,5	0,14 - 2,5
Connection cross-section, multi-wire		mm <sup>2</sup>	0,14 - 2,5	0,14 - 2,5	0,14 - 2,5	0,14 - 2,5
Connection cross-section, flexible		mm <sup>2</sup>	0,14 - 2,5	0,14 - 2,5	0,14 - 2,5	0,14 - 2,5
<b>Item No.</b>			<b>5097 45 3</b>	<b>5097 60 7</b>	<b>5097 61 5</b>	<b>5097 62 3</b>



# MCR protection for 2-pin for power supply



Surge protection device, fine protection type 3 for distributor installation

- Suitable for DC and AC voltage systems
- With visual function display
- With installation-friendly, screwless connection terminals
- In a space-saving 17.5 mm grid
- Y connection

Application: Universal use on 35 mm U-rail in every normal commercially available distribution housing.



## MCR protection for 2-pin for power supply, 110 V

Type	Version	U max AC V	U max DC V	Pack. pcs	Weight kg/100 pcs.	Item No.
<b>VF110-AC DC</b>	110 V version	150	200	1	8.000	<b>5097 63 1</b>

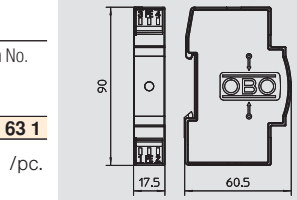

/pc.



## MCR protection for 2-pin for power supply, 230 V

Type	Version	U max AC V	U max DC V	Pack. pcs	Weight kg/100 pcs.	Item No.
<b>VF230-AC/DC</b>	230 V version	255	350	1	8.000	<b>5097 65 0</b>

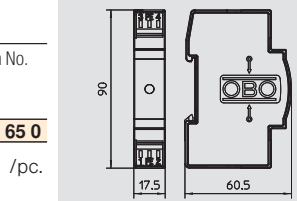

/pc.

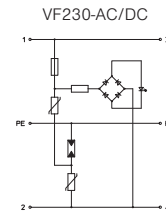
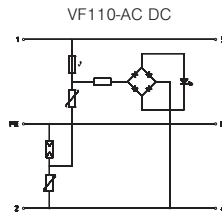

U max AC	U <sub>c</sub> AC	V	150	255
U max DC	U <sub>c</sub> DC	V	200	350
SPD to EN 61643-11			Type 3	Type 3
SPD to IEC 61643-11			class III	class III
Lightning protection Zone LPZ			2-3	2-3
Nominal discharge current (8/20)	I <sub>n</sub>	kA	2	2.5
Rated current	I <sub>L</sub>	A	20	20
Voltage protection level line-line		V	<500	<1000
Voltage protection level line-earth		V	<1400	<1400
Response time	t <sub>A</sub>	ns	<25	<25
Temperature range	θ	°C	-40 - +80	-40 - +80
Degree of protection of enclosure			IP 20	IP 20
Division unit TE (17.5 mm)			1	1
Connection cross-section, rigid		mm <sup>2</sup>	0,14 - 2,5	0,14 - 2,5
Connection cross-section, multi-wire		mm <sup>2</sup>	0,14 - 2,5	0,14 - 2,5
Connection cross-section, flexible		mm <sup>2</sup>	0,14 - 2,5	0,14 - 2,5
<b>Item No.</b>			<b>5097 63 1</b>	<b>5097 65 0</b>



# MCR protection for 2-pin for power supply with remote signalling

Surge protection device, fine protection type 3 for distributor installation

- Suitable for DC and AC voltage systems
- With visual function display
- With installation-friendly, screwless connection terminals
- In a space-saving 17.5 mm grid
- Y connection

Application: Universal use on 35 mm U-rail in every normal commercially available distribution housing.

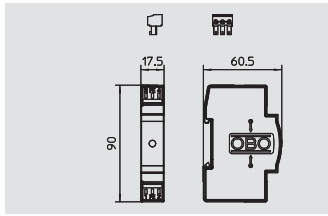

## MCR protection for 2-pin for power supply with remote signalling, 12 V AC/DC

Type	U max DC V	U max AC V	Pack. pcs	Weight kg/100 pcs.	Item No.
<b>VF12-AC/DC-FS</b>	18	13.5	1	6.400	<b>5097 45 4</b>

/pc.

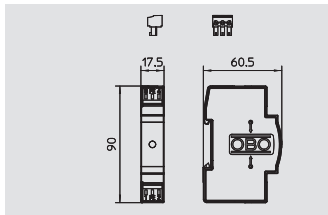

## MCR protection for 2-pin for power supply with remote signalling, 24 V AC/DC

Type	U max DC V	U max AC V	Pack. pcs	Weight kg/100 pcs.	Item No.
<b>VF24-AC/DC-FS</b>	46	34	1	6.620	<b>5097 82 0</b>

/pc.

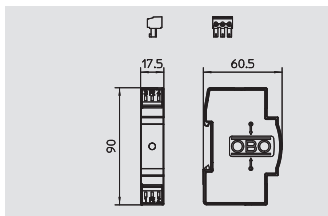

## MCR protection for 2-pin for power supply with remote signalling, 48 V AC/DC

Type	U max DC V	U max AC V	Pack. pcs	Weight kg/100 pcs.	Item No.
<b>VF48-AC/DC-FS</b>	80	60	1	6.630	<b>5097 82 2</b>

/pc.

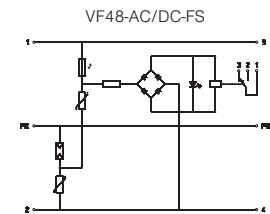
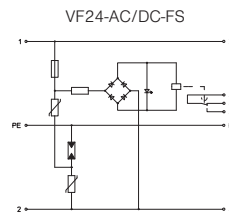
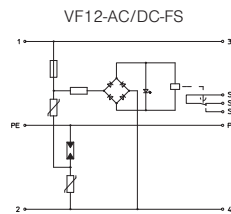

	VF12-AC/DC-FS	VF24-AC/DC-FS	VF48-AC/DC-FS	
U max AC	U <sub>c AC</sub> V	13.5	34	60
U max DC	U <sub>c DC</sub> V	18	46	80
SPD to EN 61643-11		Type 3	Type 3	Type 3
SPD to IEC 61643-11		class III	class III	class III
Lightning protection Zone LPZ		2-3	2-3	2-3
Nominal discharge current (8/20)	I <sub>n</sub> kA	0,7	0,7	0,7
Rated current	I <sub>L</sub> A	20	20	20
Voltage protection level line-line	V	<110	<160	<220
Voltage protection level line-earth	V	<1200	<1200	<1200
Response time	t <sub>A</sub> ns	< 25	< 25	< 25
Temperature range	θ °C	-40 - +80	-40 - +80	-40 - +80
Degree of protection of enclosure		20	IP 20	IP 20
Division unit TE (17.5 mm)		1	1	1
Connection cross-section, rigid	mm <sup>2</sup>	0,14 - 2,5	0,14 - 2,5	0,14 - 2,5
Connection cross-section, multi-wire	mm <sup>2</sup>	0,14 - 2,5	0,14 - 2,5	0,14 - 2,5
Connection cross-section, flexible	mm <sup>2</sup>	0,14 - 2,5	0,14 - 2,5	0,14 - 2,5
<b>Item No.</b>		<b>5097 45 4</b>	<b>5097 82 0</b>	<b>5097 82 2</b>



# MCR protection for 2-pin for power supply with remote signalling



Surge protection device, fine protection type 3 for distributor installation

- Suitable for DC and AC voltage systems
- With visual function display
- With installation-friendly, screwless connection terminals
- In a space-saving 17.5 mm grid
- Y connection

Application: Universal use on 35 mm U-rail in every normal commercially available distribution housing.



## MCR protection for 2-pin for power supply with remote signalling, 60 V AC

Type	U max DC V	U max AC V	Pack. pcs	Weight kg/100 pcs.	Item No.
<b>VF60-AC/DC-FS</b>	110	80	1	6.900	<b>5097 82 4</b>

/pc.

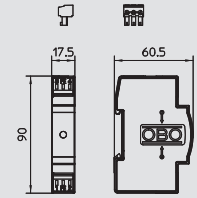

## MCR protection for 2-pin for power supply with remote signalling, 110 V AC/DC

Type	U max DC V	U max AC V	Pack. pcs	Weight kg/100 pcs.	Item No.
<b>VF110-AC DC-FS</b>	200	150	1	6.600	<b>5097 84 6</b>

/pc.

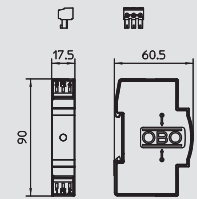

## MCR protection for 2-pin for power supply with remote signalling, 230 V AC

Type	U max DC V	U max AC V	Pack. pcs	Weight kg/100 pcs.	Item No.
<b>VF230-AC-FS</b>	—	255	1	6.910	<b>5097 85 8</b>

/pc.

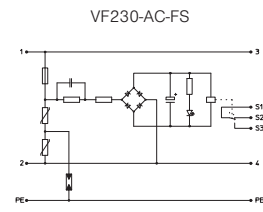
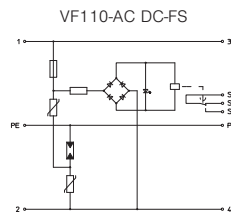
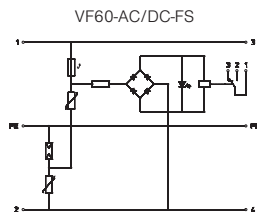
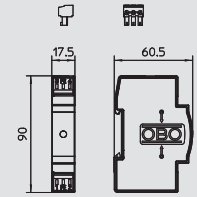

U max AC	U <sub>c</sub> AC V	80	150	255
U max DC	U <sub>c</sub> DC V	110	200	
SPD to EN 61643-11		Type 3	Type 3	Type 3
SPD to IEC 61643-11		class III	class III	class III
Lightning protection Zone LPZ		2→3	2→3	2→3
Nominal discharge current (8/20)	I <sub>n</sub> kA	0.7	2	2.5
Rated current	I <sub>L</sub> A	20	20	20
Voltage protection level line-line	V	<280	<500	<1060
Voltage protection level line-earth	V	<1200	<1300	<1400
Response time	t <sub>A</sub> ns	<25	<25	<25
Temperature range	θ °C	-40 - +80	-40 - +80	-40 - +80
Degree of protection of enclosure		IP 20	IP 20	IP 20
Division unit TE (17.5 mm)		1	1	1
Connection cross-section, rigid	mm <sup>2</sup>	0,14 - 2,5	0,14 - 2,5	0,14 - 2,5
Connection cross-section, multi-wire	mm <sup>2</sup>	0,14 - 2,5	0,14 - 2,5	0,14 - 2,5
Connection cross-section, flexible	mm <sup>2</sup>	0,14 - 2,5	0,14 - 2,5	0,14 - 2,5
<b>Item No.</b>		<b>5097 82 4</b>	<b>5097 84 6</b>	<b>5097 85 8</b>



# MCR protection for 2-pin for power supply with leak current-free remote signalling

Type 3 surge protection/fine network protection with leak current-free remote signalling

- With remote signalling: potential-free NC contact for function monitoring
- With installation-friendly, screwless connection terminals
- In space-saving 17.5 mm grid
- Y circuit

Application: Universal use on 35 mm hat profile rails in any standard distributor housing.

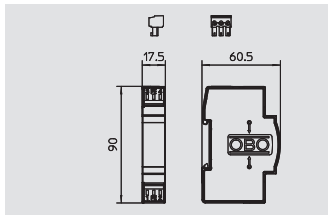

## MCR protection for 2-pin for power supply with leak current-free remote signalling, 24 V AC/DC

Type	U max AC V	U max DC V	Pack. pcs	Weight kg/100 pcs.	Item No.
<b>VF2-24-AC/DC-FS</b>	34	46	1	6.000	<b>5097 93 1</b>

/pc.

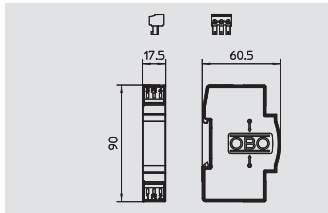

## MCR protection for 2-pin for power supply with leak current-free remote signalling, 110 V AC/DC

Type	U max AC V	U max DC V	Pack. pcs	Weight kg/100 pcs.	Item No.
<b>VF2-110-AC/DCFS</b>	150	200	1	6.000	<b>5097 93 5</b>

/pc.

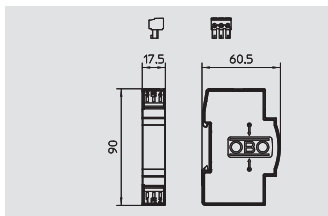

## MCR protection for 2-pin for power supply with leak current-free remote signalling, 230 V AC/DC

Type	U max AC V	U max DC V	Pack. pcs	Weight kg/100 pcs.	Item No.
<b>VF2-230-AC/DC-FS</b>	255	350	1	6.000	<b>5097 93 9</b>

/pc.

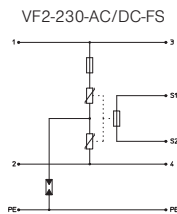
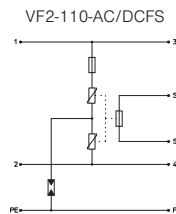
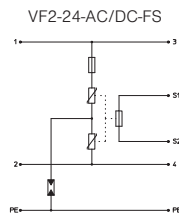

	VF2-24-AC/DC-FS	VF2-110-AC/DCFS	VF2-230-AC/DC-FS
U max AC	34	150	255
U max DC	46	200	350
SPD to EN 61643-11	Type 3	Type 3	Type 3
SPD to IEC 61643-11	class III	class III	class III
Lightning protection Zone LPZ	2-3	2-3	2-3
Nominal discharge current (8/20)	2.5	2.5	2.5
Rated current	20	20	20
Voltage protection level line-line	< 130	< 220	< 1000
Voltage protection level line-earth	< 1200	< 1200	< 1400
Response time	<25	<25	<25
Temperature range	-40 - +80	-40 - +80	-40 - +80
Degree of protection of enclosure	IP 20	IP 20	IP 20
Division unit TE (17.5 mm)	1	1	1
Connection cross-section, rigid	0,14 - 2,5	0,14 - 2,5	0,14 - 2,5
Connection cross-section, multi-wire	0,14 - 2,5	0,14 - 2,5	0,14 - 2,5
Connection cross-section, flexible	0,14 - 2,5	0,14 - 2,5	0,14 - 2,5
<b>Item No.</b>	<b>5097 93 1</b>	<b>5097 93 5</b>	<b>5097 93 9</b>



## MSR protection for two-core systems: the plus of the FRD/FLD family

- +High arresting capacity
- +Low protection level
- +Universally usable
- +Simple mounting using screwless terminals
- +High bandwidth
- +UL-listed



The use of lightning barriers in two-core wire systems is commonplace. These surge protection devices are used from telecommunication cables through bus systems up to measurement and control technology. Surge protection technology allows flexible protection for all kinds of applications. All the devices have both a low protection level and a high arresting capacity.



# MCR protection for two-core systems

Data cable protection devices for two-wire dual core systems

- Available as basic, medium and fine protection
- Low protection level at high current load
- Screwless terminals
- Bandwidth-optimised for secure transmission
- Quick mounting on hat rail or wall mounting



Application: Control systems, bus systems, communications systems

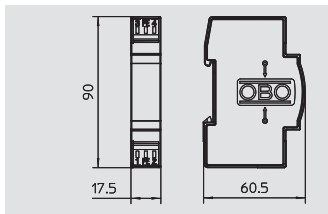

## Basic protection for two-core systems with HF applications 120 V

Type	Max. continuous operating voltage Vc/AC V	Max. continuous operating voltage Vc/DC V	Number of poles	Connection system	Pack. pcs	Weight kg/100 pcs.	Item No.
<b>TKS-B</b>	120	170	2	Terminal	1	4.400	<b>5097 97 6</b>

/pc.

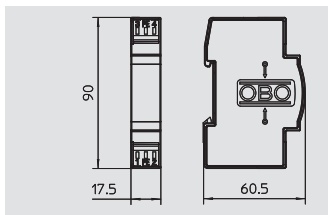
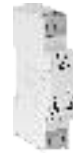

## Combination protection for two-core systems with HF applications 5 V

Type	Max. continuous operating voltage Vc/AC V	Max. continuous operating voltage Vc/DC V	Number of poles	Connection system	Pack. pcs	Weight kg/100 pcs.	Item No.
<b>FRD 5 HF</b>	4	6	2	Terminal	1	4.400	<b>5098 57 1</b>

/pc.

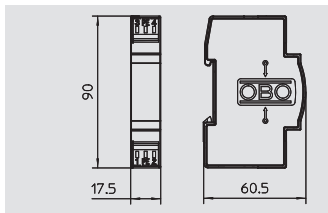

## Combination protection for two-core systems with HF applications 24 V

Type	Max. continuous operating voltage Vc/AC V	Max. continuous operating voltage Vc/DC V	Number of poles	Connection system	Pack. pcs	Weight kg/100 pcs.	Item No.
<b>FRD 24 HF</b>	19	28	2	Terminal	1	4.400	<b>5098 57 5</b>

/pc.

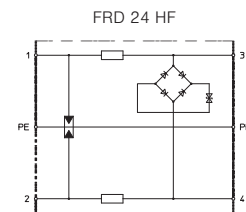
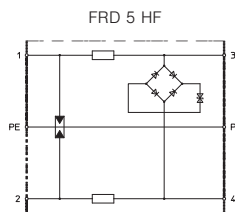
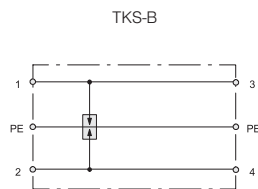

Maximum continuous operating voltage Vc/AC	V	120	4	19
Maximum continuous operating voltage Vc/DC	V	170	6	28
Lightning protection Zone LPZ		0-3	0-3	0-3
Number of poles		2	2	2
Rated current $I_L$	A	20	0.45	0.45
Serial impedance per path	$\Omega$	-	2,2 ± 10 %	2,2 ± 10 %
Impulse durability line-line		C2: 18 kV / 9 kA	C2: 18 kV / 9 kA	C2: 18 kV / 9 kA
Impulse durability line-earth		C2: 18 kV / 9 kA	C2: 18 kV / 9 kA	C2: 18 kV / 9 kA
Total impulse durability (10/350)	kA	D1: 6	D1: 6	D1: 6
Total impulse durability (8/20)	kA	18	18	18
Voltage protection level line-line	V	950	90	120
Voltage protection level line-earth	V	600	650	650
Shielding connection available		No	No	No
Shield connection		-	-	-
Temperature range $\vartheta$	°C	-40 - +80	-40 - +80	-40 - +80
Division unit TE (17.5 mm)		1	1	1
Connection cross-section, flexible	mm <sup>2</sup>	0,14 - 2,5	0,14 - 2,5	0,14 - 2,5
Connection cross-section, multi-wire	mm <sup>2</sup>	0,14 - 2,5	0,14 - 2,5	0,14 - 2,5
Connection cross-section, rigid	mm <sup>2</sup>	0,14 - 2,5	0,14 - 2,5	0,14 - 2,5
Testing standard		IEC 61643-21	IEC 61643-21	IEC 61643-21
<b>Item No.</b>		<b>5097 97 6</b>	<b>5098 57 1</b>	<b>5098 57 5</b>



# MCR protection for two-core systems



Surge protection for use in measurement and control technology

- Medium and fine protection
- Standard design for double core systems
- Two-stage protection circuit
- With installation-friendly, screwless connection terminals
- In space-saving 17.5 mm grid
- With ohmic decoupling in the longitudinal branch

Application: Universal use on any 35 mm hat profile rail in every commercially available distributor housing.

## Medium and fine protection for two-core systems 5 V

Type	Max. continuous operating voltage Vc/AC V	Max. continuous operating voltage Vc/DC V	Number of poles	Connection system	Pack. pcs	Weight kg/100 pcs.	Item No.
<b>FRD 5</b>	5	8	2	Terminal	1	5.100	<b>5098 49 2</b>

/pc.

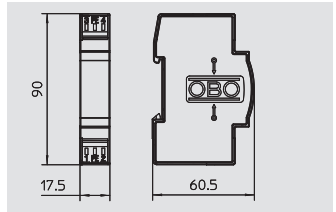

## Medium and fine protection for two-core systems 12 V

Type	Max. continuous operating voltage Vc/AC V	Max. continuous operating voltage Vc/DC V	Number of poles	Connection system	Pack. pcs	Weight kg/100 pcs.	Item No.
<b>FRD 12</b>	9	13	2	Terminal	1	5.100	<b>5098 50 6</b>

/pc.

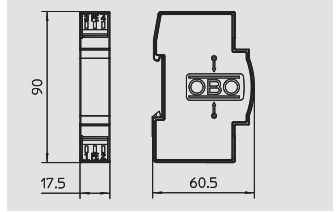

## Medium and fine protection for two-core systems 24 V

Type	Max. continuous operating voltage Vc/AC V	Max. continuous operating voltage Vc/DC V	Number of poles	Connection system	Pack. pcs	Weight kg/100 pcs.	Item No.
<b>FRD 24</b>	19	28	2	Terminal	1	5.100	<b>5098 51 4</b>

/pc.

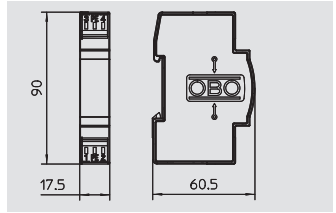

## Medium and fine protection for two-core systems 48 V

Type	Max. continuous operating voltage Vc/AC V	Max. continuous operating voltage Vc/DC V	Number of poles	Connection system	Pack. pcs	Weight kg/100 pcs.	Item No.
<b>FRD 48</b>	37	53	2	Terminal	1	5.100	<b>5098 52 2</b>

/pc.

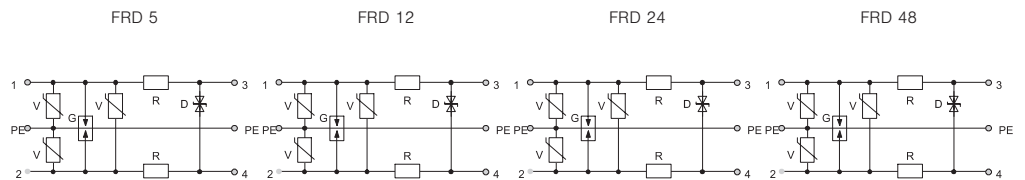
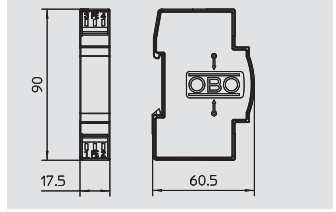

Maximum continuous operating voltage Vc/AC	V	5	9	19	37
Maximum continuous operating voltage Vc/DC	V	8	13	28	53
Lightning protection Zone LPZ		0-3	0-3	0-3	0-3
Number of poles		2	2	2	2
Rated current I <sub>L</sub>	A	0.2	0.2	0.2	0.2
Serial impedance per path	Ω	15 ± 10 %	15 ± 10 %	15 ± 10 %	0,14 ÷ 2,5
Impulse durability line-line		C1: 0.5 kV / 0.5 kA	C1: 1 kV / 0.5 kA	C2: 5 kV / 2.5 kA	C2: 5 kV / 2.5 kA
Impulse durability line-earth		C2: 10 kV / 5 kA	C2: 10 kV / 5 kA	C2: 10 kV / 5 kA	C2: 10 kV / 5 kA
Total impulse durability (10/350)	kA	D1: 3 kA	D1: 3	D1: 3	D1: 3
Total impulse durability (8/20)	kA	10	10	10	10
Voltage protection level line-line	V	15	30	60	140
Voltage protection level line-earth	V	600	600	600	600
Shielding connection available		No	No	No	No
Shield connection		-	-	-	-
Temperature range θ	°C	-40 - +80	-40 - +80	-40 - +80	-40 - +80
Division unit TE (17.5 mm)		1	1	1	1
Connection cross-section, flexible	mm <sup>2</sup>	0,14 - 2,5	0,14 - 2,5	0,14 - 2,5	0,14 - 2,5
Connection cross-section, multi-wire	mm <sup>2</sup>	0,14 - 2,5	0,14 - 2,5	0,14 - 2,5	0,14 - 2,5
Connection cross-section, rigid	mm <sup>2</sup>	0,14 - 2,5	0,14 - 2,5	0,14 - 2,5	0,14 - 2,5
Testing standard		IEC 61643-21	IEC 61643-21	IEC 61643-21	IEC 61643-21
<b>Item No.</b>		<b>5098 49 2</b>	<b>5098 50 6</b>	<b>5098 51 4</b>	<b>5098 52 2</b>





# MCR protection for two-core systems

Surge protection for use in measurement and control technology



- Medium and fine protection
- Standard design for double core systems
- Two-stage protection circuit
- With installation-friendly, screwless connection terminals
- In space-saving 17.5 mm grid
- With ohmic decoupling in the longitudinal branch

Application: Universal use on any 35 mm hat profile rail in every commercially available distributor housing.

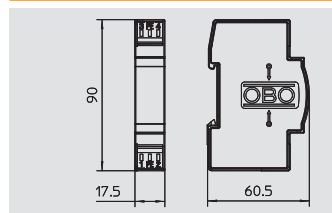

## Medium and fine protection for two-core systems 110 V

Type	Max. continuous operating voltage Vc/AC V	Max. continuous operating voltage Vc/DC V	Number of poles	Connection system	Pack. pcs	Weight kg/100 pcs.	Item No.
<b>FRD 110</b>	86	122	2	Terminal	1	5.100	<b>5098 55 7</b>

/pc.



FRD 110

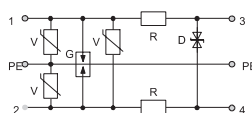

Maximum continuous operating voltage Vc/AC	V	86
Maximum continuous operating voltage Vc/DC	V	122
Lightning protection Zone LPZ		0-3
Number of poles		2
Rated current $I_L$	A	0.2
Serial impedance per path	$\Omega$	15 ± 10 %
Impulse durability line-line		C2: 5 kV / 2.5 kA
Impulse durability line-earth		C2: 10 kV / 5 kA
Total Impulse durability (10/350)	kA	D1: 3
Total Impulse durability (8/20)	kA	10
Voltage protection level line-line	V	300
Voltage protection level line-earth	V	600
Shielding connection available		No
Shield connection		-
Temperature range $\vartheta$	°C	-40 - +80
Division unit TE (17.5 mm)		1
Connection cross-section, flexible	mm <sup>2</sup>	0,14 - 2,5
Connection cross-section, multi-wire	mm <sup>2</sup>	0,14 - 2,5
Connection cross-section, rigid	mm <sup>2</sup>	0,14 - 2,5
Testing standard		IEC 61643-21
<b>Item No.</b>		<b>5098 55 7</b>



# MCR protection for two-core systems



Surge protection for use in measurement and control technology

- Medium and fine protection
- Standard design for single core systems
- Two-stage protection circuit
- With installation-friendly, screwless connection terminals
- In space-saving 17.5 mm grid
- With ohmic decoupling in the longitudinal branch

Application: Universal use on any 35 mm hat profile rail in every commercially available distributor housing.

## Medium and fine protection for two-core systems 5 V

Type	Max. continuous operating voltage Vc/AC V	Max. continuous operating voltage Vc/DC V	Number of poles	Connection system	Pack. pcs	Weight kg/100 pcs.	Item No.
<b>FRD 2-5</b>	5	8	2	Terminal	1	5.100	<b>5098 79 4</b>

/pc.

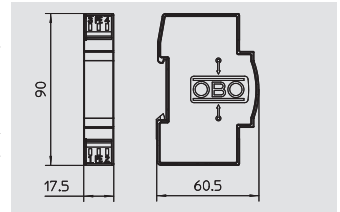

## Medium and fine protection for two-core systems 24 V

Type	Max. continuous operating voltage Vc/AC V	Max. continuous operating voltage Vc/DC V	Number of poles	Connection system	Pack. pcs	Weight kg/100 pcs.	Item No.
<b>FRD 2-24</b>	19	28	2	Terminal	1	5.100	<b>5098 72 7</b>

/pc.

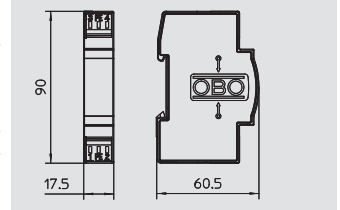

FRD 2-5

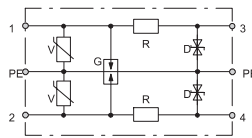

FRD 2-24

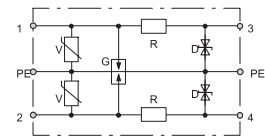

Maximum continuous operating voltage Vc/AC	V	5	19
Maximum continuous operating voltage Vc/DC	V	8	28
Lightning protection Zone LPZ		0-3	0-3
Number of poles		2	2
Rated current	$I_L$	A	0.2
Serial impedance per path	$\Omega$	$15 \pm 10 \%$	$15 \pm 10 \%$
Impulse durability line-line		C1: 1 kV / 0.5 kA	C2: 5 kV / 2.5 kA
Impulse durability line-earth		C1: 1 kV / 0.5 kA	C2: 5 kV / 2.5 kA
Total impulse durability	$I_{Total}$	kA	C2: 10kV / 5 kA
Voltage protection level line-line	V	30	120
Voltage protection level line-earth	V	15	60
Shielding connection available		No	No
Shield connection		-	-
Temperature range	$\vartheta$	°C	-40 - +80
Division unit TE (17.5 mm)		1	1
Connection cross-section, flexible	mm <sup>2</sup>	0,14 - 2,5	0,14 - 2,5
Connection cross-section, multi-wire	mm <sup>2</sup>	0,14 - 2,5	0,14 - 2,5
Connection cross-section, rigid	mm <sup>2</sup>	0,14 - 2,5	0,14 - 2,5
Testing standard		IEC 61643-21	IEC 61643-21
<b>Item No.</b>		<b>5098 79 4</b>	<b>5098 72 7</b>



# MCR protection for two-core systems

Surge protection for use in measurement and control technology



- Medium and fine protection
- Standard design for single core systems
- Two-stage protection circuit
- With installation-friendly, screwless connection terminals
- In space-saving 17.5 mm grid
- With inductive decoupling in the longitudinal branch

Application: Universal use on any 35 mm hat profile rail in every commercially available distributor housing.

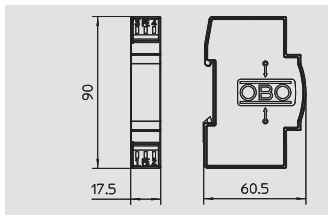

## Medium and fine protection for two-core systems 5 V

Type	Max. continuous operating voltage Vc/AC V	Max. continuous operating voltage Vc/DC V	Number of poles	Connection system	Pack. pcs	Weight kg/100 pcs.	Item No.
<b>FLD 5</b>	5	8	2	Terminal	1	5.200	<b>5098 60 0</b>

/pc.

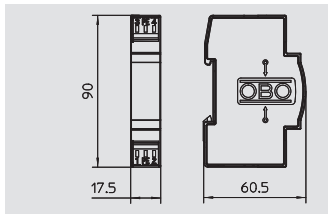

## Medium and fine protection for two-core systems 12 V

Type	Max. continuous operating voltage Vc/AC V	Max. continuous operating voltage Vc/DC V	Number of poles	Connection system	Pack. pcs	Weight kg/100 pcs.	Item No.
<b>FLD 12</b>	9	13	2	Terminal	1	5.200	<b>5098 60 3</b>

/pc.

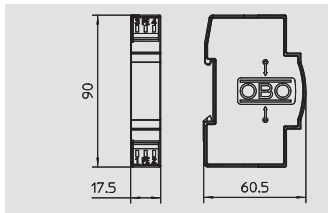

## Medium and fine protection for two-core systems 24 V

Type	Max. continuous operating voltage Vc/AC V	Max. continuous operating voltage Vc/DC V	Number of poles	Connection system	Pack. pcs	Weight kg/100 pcs.	Item No.
<b>FLD 24</b>	19	28	2	Terminal	1	5.200	<b>5098 61 1</b>

/pc.

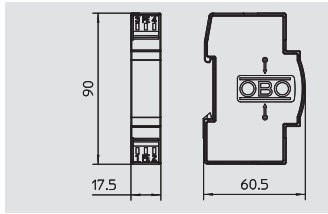

## Medium and fine protection for two-core systems 48 V

Type	Max. continuous operating voltage Vc/AC V	Max. continuous operating voltage Vc/DC V	Number of poles	Connection system	Pack. pcs	Weight kg/100 pcs.	Item No.
<b>FLD 48</b>	37	53	2	Terminal	1	5.200	<b>5098 63 0</b>

/pc.

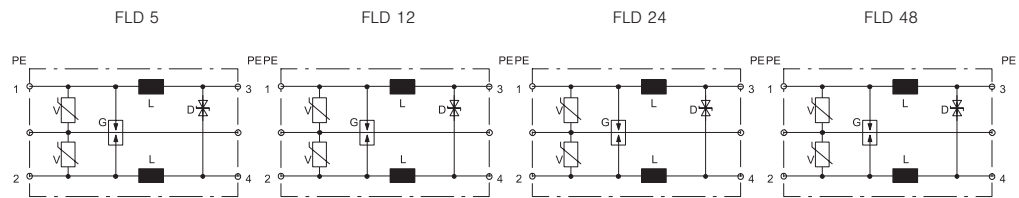

Maximum continuous operating voltage Vc/AC	V	5	9	19	37
Maximum continuous operating voltage Vc/DC	V	8	13	28	53
Lightning protection Zone LPZ		0→3	0→3	0→3	0→3
Number of poles		2	2	2	2
Rated current I <sub>L</sub>	A	1	1	1	1
Series inductance per path	μH	120 ± 20 %	120 ± 20 %	120 ± 20 %	120 ± 20 %
Impulse durability line-line		C1: 1 kV / 0.5 kA	C1: 1 kV / 0.5 kA	C1: 5 kV / 2.5 kA	C1: 5 kV / 2.5 kA
Impulse durability line-earth		C2: 10 kV / 5 kA	C2: 10 kV / 5 kA	C2: 10 kV / 5 kA	C2: 10 kV / 5 kA
Total impulse durability (10/350)	kA	D1: 3	D1: 3	D1: 3	D1: 3
Total impulse durability (8/20)	kA	10	10	10	10
Voltage protection level line-line	V	15	30	60	140
Voltage protection level line-earth	V	600	600	600	600
Shielding connection available		No	No	No	No
Shield connection		-	-	-	-
Temperature range θ	°C	-40 - +80	-40 - +80	-40 - +80	-40 - +80
Division unit TE (17.5 mm)		1	1	1	1
Connection cross-section, flexible	mm <sup>2</sup>	0,14 - 2,5	0,14 - 2,5	0,14 - 2,5	0,14 - 2,5
Connection cross-section, multi-wire	mm <sup>2</sup>	0,14 - 2,5	0,14 - 2,5	0,14 - 2,5	0,14 - 2,5
Connection cross-section, rigid	mm <sup>2</sup>	0,14 - 2,5	0,14 - 2,5	0,14 - 2,5	0,14 - 2,5
Testing standard		IEC 61643-21	IEC 61643-21	IEC 61643-21	IEC 61643-21
<b>Item No.</b>		<b>5098 60 0</b>	<b>5098 60 3</b>	<b>5098 61 1</b>	<b>5098 63 0</b>

Always indicate the item number when ordering.

# MCR protection for two-core systems



Surge protection for use in measurement and control technology

- Medium and fine protection
- Standard design for single core systems
- Two-stage protection circuit
- With installation-friendly, screwless connection terminals
- In space-saving 17.5 mm grid
- With inductive decoupling in the longitudinal branch

Application: Universal use on any 35 mm hat profile rail in every commercially available distributor housing.

## Medium and fine protection for two-core systems 60 V

Type	Max. continuous operating voltage V <sub>c</sub> /AC	Max. continuous operating voltage V <sub>c</sub> /DC	Number of poles	Connection system	Pack. pcs	Weight kg/100 pcs.	Item No.
<b>FLD 60</b>	65	93	2	Terminal	1	5.200	<b>5098 63 8</b>

/pc.

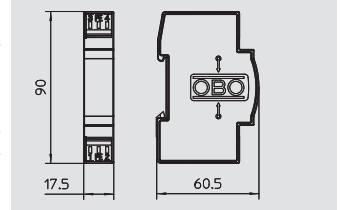

## Medium and fine protection for two-core systems 110 V

Type	Max. continuous operating voltage V <sub>c</sub> /AC	Max. continuous operating voltage V <sub>c</sub> /DC	Number of poles	Connection system	Pack. pcs	Weight kg/100 pcs.	Item No.
<b>FLD 110</b>	86	122	2	Terminal	1	5.200	<b>5098 64 6</b>

/pc.

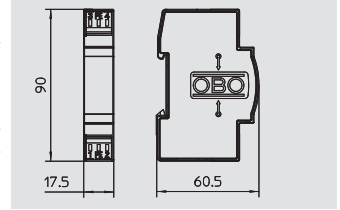

FLD 60

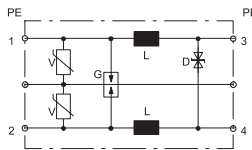

FLD 110

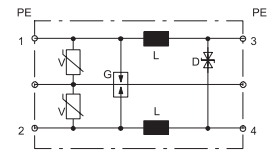

Maximum continuous operating voltage V <sub>c</sub> /AC	V	65	86
Maximum continuous operating voltage V <sub>c</sub> /DC	V	93	122
Lightning protection Zone LPZ		0-3	0-3
Number of poles		2	2
Rated current I <sub>L</sub>	A	1	1
Series induction per path	μH	120 ± 20 %	120 ± 20 %
Impulse durability line-line		C1: 1 kV / 0.5 kA	C1: 1 kV / 0.5 kA
Impulse durability line-earth		C2: 10 kV / 5 kA	C1: 1 kV / 0.5 kA
Total impulse durability (10/350)	kA	D1: 3	D1: 3
Total impulse durability (8/20)	kA	10	10
Voltage protection level line-line	V	160	300
Voltage protection level line-earth	V	600	600
Shielding connection available		No	No
Shield connection		-	-
Temperature range θ	°C	-40 - +80	-40 - +80
Division unit TE (17.5 mm)		1	1
Connection cross-section, flexible	mm <sup>2</sup>	0,14 - 2,5	0,14 - 2,5
Connection cross-section, multi-wire	mm <sup>2</sup>	0,14 - 2,5	0,14 - 2,5
Connection cross-section, rigid	mm <sup>2</sup>	0,14 - 2,5	0,14 - 2,5
Testing standard		IEC 61643-21	IEC 61643-21
<b>Item No.</b>		<b>5098 63 8</b>	<b>5098 64 6</b>



# MCR protection for two-core systems

Surge protection for use in measurement and control technology



- Medium and fine protection
- Standard design for single core systems
- Two-stage protection circuit
- With installation-friendly, screwless connection terminals
- In space-saving 17.5 mm grid
- With inductive decoupling in the longitudinal branch

Application: Universal use on any 35 mm hat profile rail in every commercially available distributor housing.

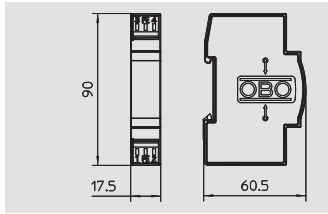

## Medium and fine protection for two-core systems 5 V

Type	Max. continuous operating voltage Vc/AC V	Max. continuous operating voltage Vc/DC V	Number of poles	Connection system	Pack. pcs	Weight kg/100 pcs.	Item No.
<b>FLD 2-5</b>	5	8	2	Terminal	1	5.100	<b>5098 86 7</b>

/pc.

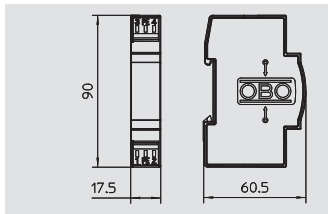

## Medium and fine protection for two-core systems 12 V

Type	Max. continuous operating voltage Vc/AC V	Max. continuous operating voltage Vc/DC V	Number of poles	Connection system	Pack. pcs	Weight kg/100 pcs.	Item No.
<b>FLD 2-12</b>	9	13	2	Terminal	1	5.100	<b>5098 80 8</b>

/pc.

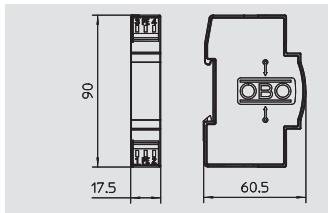

## Medium and fine protection for two-core systems 24 V

Type	Max. continuous operating voltage Vc/AC V	Max. continuous operating voltage Vc/DC V	Number of poles	Connection system	Pack. pcs	Weight kg/100 pcs.	Item No.
<b>FLD 2-24</b>	28	19	2	Terminal	1	5.100	<b>5098 81 6</b>

/pc.

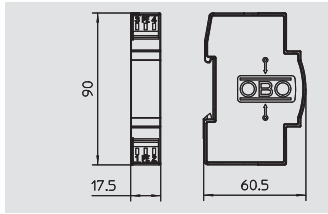

## Medium and fine protection for two-core systems 48 V

Type	Max. continuous operating voltage Vc/AC V	Max. continuous operating voltage Vc/DC V	Number of poles	Connection system	Pack. pcs	Weight kg/100 pcs.	Item No.
<b>FLD 2-48</b>	37	53	2	Terminal	1	5.100	<b>5098 82 4</b>

/pc.

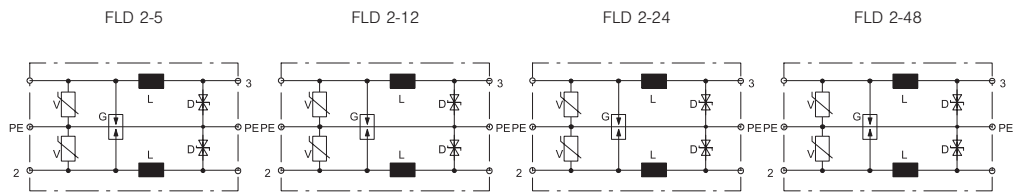

Maximum continuous operating voltage Vc/AC	V	5	9	28	37
Maximum continuous operating voltage Vc/DC	V	8	13	19	53
Lightning protection Zone LPZ		0-3	0-3	0-3	0-3
Number of poles		2	2	2	2
Rated current	I <sub>L</sub> A	1	1	1	1
Series inductance per path	μH	120 ± 10 %	120 ± 10 %	120 ± 10 %	120 ± 10 %
Impulse durability line-line		C1: 1 kV / 0.5 kA	C1: 1 kV / 0.5 kA	C1: 1 kV / 0.5 kA	C1: 5 kV / 0.25 kA
Impulse durability line-earth		C1: 1 kV / 0.5 kA	C1: 1 kV / 0.5 kA	C1: 1 kV / 0.5 kA	C1: 5 kV / 0.25 kA
Total impulse durability	I <sub>total</sub> kA	C2: 2kV / 1 kA	C2: 2kV / 1 kA	C2: 2kV / 1 kA	C2: 1kV / 0.5 kA
Voltage protection level line-line	V	30	60	120	240
Voltage protection level line-earth	V	15	30	60	130
Shielding connection available		No	No	No	No
Shield connection		-	-	-	-
Temperature range	θ °C	-40 - +80	-40 - +80	-40 - +80	-40 - +80
Division unit TE (17.5 mm)		1	1	1	1
Connection cross-section, flexible	mm <sup>2</sup>	0,14 - 2,5	0,14 - 2,5	0,14 - 2,5	0,14 - 2,5
Connection cross-section, multi-wire	mm <sup>2</sup>	0,14 - 2,5	0,14 - 2,5	0,14 - 2,5	0,14 - 2,5
Connection cross-section, rigid	mm <sup>2</sup>	0,14 - 2,5	0,14 - 2,5	0,14 - 2,5	0,14 - 2,5
Testing standard		IEC 61643-21	IEC 61643-21	IEC 61643-21	IEC 61643-21
<b>Item No.</b>		<b>5098 86 7</b>	<b>5098 80 8</b>	<b>5098 81 6</b>	<b>5098 82 4</b>

Always indicate the item number when ordering.

# MCR protection for two-core systems



Surge protection for use in measurement and control technology

- Medium and fine protection
- Standard design for single core systems
- Two-stage protection circuit
- With installation-friendly, screwless connection terminals
- In space-saving 17.5 mm grid
- With inductive decoupling in the longitudinal branch

Application: Universal use on any 35 mm hat profile rail in every commercially available distributor housing.



## Medium and fine protection for two-core systems 110 V

Type	Max. continuous operating voltage Vc/AC V	Max. continuous operating voltage Vc/DC V	Number of poles	Connection system	Pack. pcs	Weight kg/100 pcs.	Item No.
<b>FLD 2-110</b>	86	122	2	Terminal	1	5.100	<b>5098 85 9</b>

/pc.

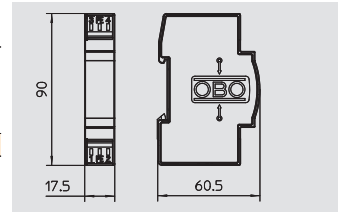

Surge protection device for data and information technology



FLD 2-110

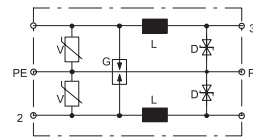

Maximum continuous operating voltage Vc/AC	V	86
Maximum continuous operating voltage Vc/DC	V	122
Lightning protection Zone LPZ		0→3
Number of poles		2
Rated current I <sub>L</sub>	A	1
Series induction per path	μH	120 ± 10 %
Impulse durability line-line		C1: 5 kV / 2.5 kA
Impulse durability line-earth		C1: 5 kV / 2.5 kA
Total impulse durability I <sub>Total</sub>	kA	C2: 10 kV / 5 kA
Voltage protection level line-line	V	500
Voltage protection level line-earth	V	300
Shielding connection available		No
Shield connection		-
Temperature range θ	°C	-40 - +80
Division unit TE (17.5 mm)		1
Connection cross-section, flexible	mm <sup>2</sup>	0,14 - 2,5
Connection cross-section, multi-wire	mm <sup>2</sup>	0,14 - 2,5
Connection cross-section, rigid	mm <sup>2</sup>	0,14 - 2,5
Testing standard		IEC 61643-21
<b>Item No.</b>		<b>5098 85 9</b>

## MCR protection for multi-wire systems (testable): the plus of the MDP family

- +Protection device for multi-wire systems (4-pole)
- +Direct shield earthing
- +Easy-mounting, screwless connection terminals
- +Space-saving width of just 8.1 mm
- +Versions with nominal currents up to 10 A
- +High frequency bandwidth up to 100 MHz
- +UL-listed



Besides the high current capacity, the lightning barriers of type MDP offer a narrow installation width of just 8 mm. A separate screen connection permits shield attachment on both sides of the equipotential bonding, thus optimising the shield

effect against capacitive and inductive couplings. Depending on the version, a nominal current of up to 10 A can be applied to the devices, meaning that they are thus ideally suited to use in special applications, such as slip ring

transmitters or heating systems in wind power systems. When installed, all the MDPS can be checked using LifeControl.



# MCR protection for multi-wire systems (testable)



Testable data cable protection devices for multi-wire systems

- Narrow installation width of only 8 mm
- Low protection level for high current load
- Screwless terminals
- Bandwidth-optimised for secure transmission
- Quick mounting on hat rail or wall mounting
- Testable in installed state

Application: Measuring technology, switchgear cabinet construction, etc.



## Series protection device, 2-pole, 5 V version

Type	Max. continuous operating voltage Vc/AC V	Max. continuous operating voltage Vc/DC V	Number of poles	Connection system	Pack. pcs	Weight kg/100 pcs.	Item No.
<b>MDP-2 D-5-T</b>	7	10	2	Terminal	1	6.000	<b>5098 40 4</b>

/pc.

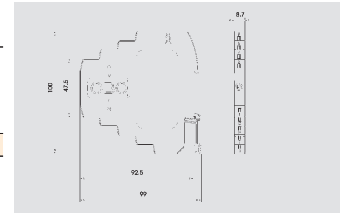

## Series protection device, 3-pole, 5 V version

Type	Max. continuous operating voltage Vc/AC V	Max. continuous operating voltage Vc/DC V	Number of poles	Connection system	Pack. pcs	Weight kg/100 pcs.	Item No.
<b>MDP-3 D-5-T</b>	7	10	3	Terminal	1	6.000	<b>5098 40 7</b>

/pc.

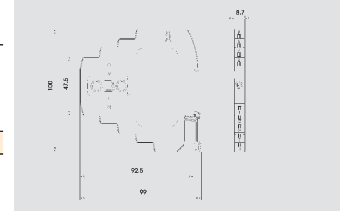

## Series protection device, 4-pole, 5 V version

Type	Max. continuous operating voltage Vc/AC V	Max. continuous operating voltage Vc/DC V	Number of poles	Connection system	Pack. pcs	Weight kg/100 pcs.	Item No.
<b>MDP-4 D-5-T</b>	7	10	4	Terminal	1	6.000	<b>5098 41 1</b>

/pc.

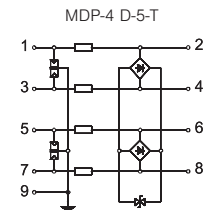
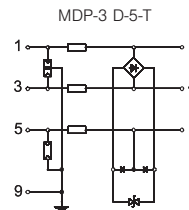
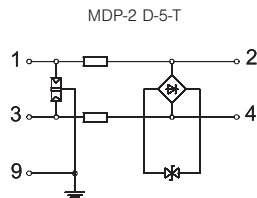
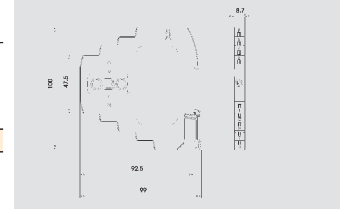

Maximum continuous operating voltage Vc/AC	V	7	7	7
Maximum continuous operating voltage Vc/DC	V	10	10	10
Lightning protection Zone LPZ		0→3	0→3	0→3
Number of poles		2	3	4
Rated current I <sub>L</sub>	A	0.58	0.58	0.58
Serial impedance per path	Ω	2,35 ± 5 %	2,35 ± 5 %	2,35 ± 5 %
Impulse durability line-line		C1: 0.5 kV / 0.25 kA	C1: 0.5 kV / 0.25 kA	C1: 0.5 kV / 0.25 kA
Impulse durability line-earth		C2: 5 kV / 2,5 kA	C2: 5 kV / 2,5 kA	C2: 5 kV / 2,5 kA
Total impulse durability (10/350)	kA	D1: 1	D1: 1,5	D1: 2kA
Total impulse durability (8/20)	kA	5	7,5	10 kA
Voltage protection level line-line	V	35	35	35
Voltage protection level line-earth	V	800	800	800
Shielding connection available		Yes	Yes	Yes
Shield connection		Direct	Direct	Direct
Temperature range θ	°C	-40 - +80	-40 - +80	-40 - +80
Connection cross-section, flexible	mm <sup>2</sup>	2.5	2.5	2.5
Connection cross-section, multi-wire	mm <sup>2</sup>	1.5	1.5	1.5
Connection cross-section, rigid	mm <sup>2</sup>	2.5	2.5	2.5
Testing standard		IEC 61643-21	IEC 61643-21	IEC 61643-21
<b>Item No.</b>		<b>5098 40 4</b>	<b>5098 40 7</b>	<b>5098 41 1</b>





# MCR protection for multi-wire systems (testable)

Testable data cable protection devices for multi-wire systems

- Narrow installation width of only 8 mm
- Low protection level for high current load
- Screwless terminals
- Bandwidth-optimised for secure transmission
- Quick mounting on hat rail or wall mounting
- Testable in installed state

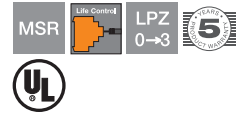

Application: Measuring technology, switchgear cabinet construction, etc.

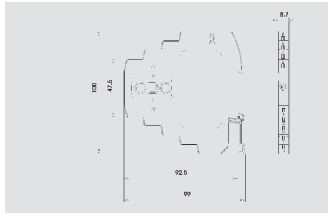

## Series protection device, 2-pole, 24 V version

Type	Max. continuous operating voltage Vc/AC V	Max. continuous operating voltage Vc/DC V	Number of poles	Connection system	Pack. pcs	Weight kg/100 pcs.	Item No.
<b>MDP-2 D-24-T</b>	20	28	2	Terminal	1	6.000	<b>5098 42 2</b>

/pc.

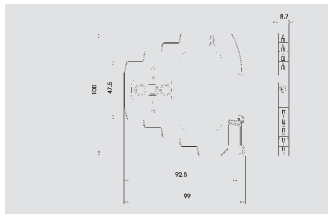

## Series protection device, 3-pole, 24 V version

Type	Max. continuous operating voltage Vc/AC V	Max. continuous operating voltage Vc/DC V	Number of poles	Connection system	Pack. pcs	Weight kg/100 pcs.	Item No.
<b>MDP-3 D-24-T</b>	20	28	3	Terminal	1	6.000	<b>5098 42 7</b>

/pc.

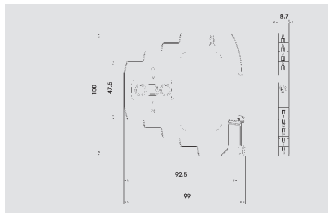

## Series protection device, 4-pole, 24 V version

Type	Max. continuous operating voltage Vc/AC V	Max. continuous operating voltage Vc/DC V	Number of poles	Connection system	Pack. pcs	Weight kg/100 pcs.	Item No.
<b>MDP-4 D-24-T</b>	20	28	4	Terminal	1	5.800	<b>5098 43 1</b>

/pc.

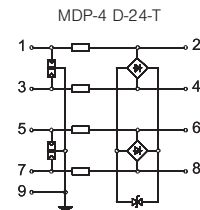
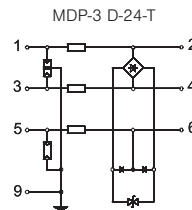
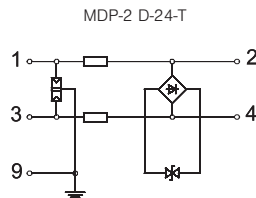

Maximum continuous operating voltage Vc/AC	V	20	20	20
Maximum continuous operating voltage Vc/DC	V	28	28	28
Lightning protection Zone LPZ		0-3	0-3	0-3
Number of poles		2	3	4
Rated current	I <sub>n</sub> A	0.58	0.58	0.58
Serial impedance per path	Ω	2,35 ± 5 %	2,35 ± 5 %	2,35 ± 5 %
Impulse durability line-line		C1: 0.5 kV / 0.25 kA	C1: 0.5 kV / 0.25 kA	C1: 0.5 kV / 0.25 kA
Impulse durability line-earth		C2: 5 kV / 2,5 kA	C2: 5 kV / 2,5 kA	C2: 5 kV / 2,5 kA
Total Impulse durability (10/350)	kA	D1: 1	D1: 1,5	D1: 2
Total Impulse durability (8/20)	kA	5	7,5	10 kA
Voltage protection level line-line	V	55	95	55
Voltage protection level line-earth	V	800	800	800
Shielding connection available		Yes	Yes	Yes
Shield connection		Direct	Direct	Direct
Temperature range	θ °C	-40 - +80	-40 - +80	-40 - +80
Connection cross-section, flexible	mm <sup>2</sup>	2.5	2.5	2.5
Connection cross-section, multi-wire	mm <sup>2</sup>	1.5	1.5	1.5
Connection cross-section, rigid	mm <sup>2</sup>	2.5	2.5	2.5
Testing standard		IEC 61643-21	IEC 61643-21	IEC 61643-21
<b>Item No.</b>		<b>5098 42 2</b>	<b>5098 42 7</b>	<b>5098 43 1</b>



# MCR protection for multi-wire systems (testable)

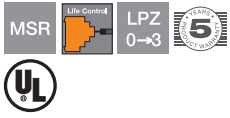

Testable data cable protection devices for multi-wire systems

- Narrow installation width of only 8 mm
- Low protection level for high current load
- Screwless terminals
- Bandwidth-optimised for secure transmission
- Quick mounting on hat rail or wall mounting
- Testable in installed state

Application: Measuring technology, switchgear cabinet construction, etc.



## Series protection device, 2-pole, 48 V version

Type	Max. continuous operating voltage Vc/AC V	Max. continuous operating voltage Vc/DC V	Number of poles	Connection system	Pack. pcs	Weight kg/100 pcs.	Item No.
<b>MDP-2 D-48-T</b>	41	58	2	Terminal	1	6.000	<b>5098 44 2</b>

/pc.

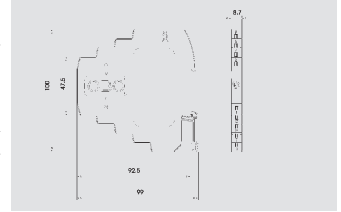

## Series protection device, 3-pole, 48 V version

Type	Max. continuous operating voltage Vc/AC V	Max. continuous operating voltage Vc/DC V	Number of poles	Connection system	Pack. pcs	Weight kg/100 pcs.	Item No.
<b>MDP-3 D-48-T</b>	41	58	3	Terminal	1	6.000	<b>5098 44 6</b>

/pc.

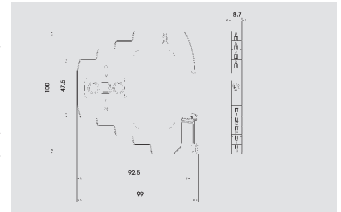

## Series protection device, 4-pole, 48 V version

Type	Max. continuous operating voltage Vc/AC V	Max. continuous operating voltage Vc/DC V	Number of poles	Connection system	Pack. pcs	Weight kg/100 pcs.	Item No.
<b>MDP-4 D-48-T</b>	41	58	4	Terminal	1	5.800	<b>5098 45 0</b>

/pc.

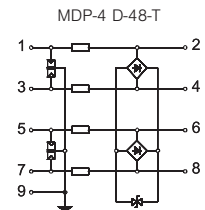
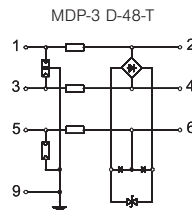
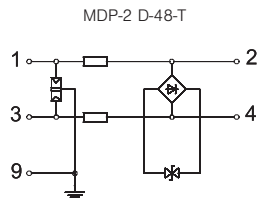
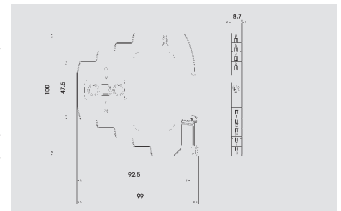

Maximum continuous operating voltage Vc/AC	V	41	41	41
Maximum continuous operating voltage Vc/DC	V	58	58	58
Lightning protection Zone LPZ		0→3	0→3	0→3
Number of poles		2	3	4
Rated current	I <sub>L</sub> A	0.58	0.58	0.58
Serial impedance per path	Ω	2,35 ± 5 %	2,35 ± 5 %	2,35 ± 5 %
Impulse durability line-line		C1: 0.5 kV / 0.25 kA	C1: 0.5 kV / 0.25 kA	C1: 0.5 kV / 0.25 kA
Impulse durability line-earth		C2: 5 kV / 2,5 kA	C2: 5 kV / 2,5 kA	C2: 5 kV / 2,5 kA
Total impulse durability (10/350)		D1: 1	D1: 1,5	D1: 2
Total impulse durability (8/20)		5	7,5	10
Voltage protection level line-line	V	95	95	95
Voltage protection level line-earth	V	800	800	800
Shielding connection available		Yes	Yes	Yes
Shield connection		Direct	Direct	Direct
Temperature range	θ °C	-40 - +80	-40 - +80	-40 - +80
Connection cross-section, flexible	mm <sup>2</sup>	2.5	2.5	2.5
Connection cross-section, multi-wire	mm <sup>2</sup>	1.5	1.5	1.5
Connection cross-section, rigid	mm <sup>2</sup>	2.5	2.5	2.5
Testing standard		IEC 61643-21	IEC 61643-21	IEC 61643-21
<b>Item No.</b>		<b>5098 44 2</b>	<b>5098 44 6</b>	<b>5098 45 0</b>



# MCR protection for multi-wire systems (testable) to 10 A

Testable data cable protection devices for multi-wire systems

- Narrow installation width of only 8 mm
- Low protection level for high current load
- Screwless terminals
- Bandwidth-optimised for secure transmission
- Quick mounting on hat rail or wall mounting
- Testable in installed state

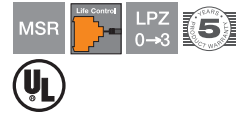

Application: Measuring technology, switchgear cabinet construction, etc.

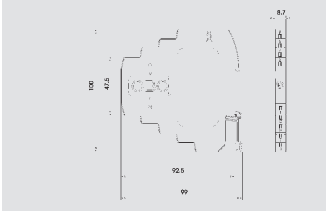

## Series protection device, 4-pole, 5 V version

Type	Max. continuous operating voltage Vc/AC V	Max. continuous operating voltage Vc/DC V	Number of poles	Connection system	Pack. pcs	Weight kg/100 pcs.	Item No.
<b>MDP-4 D-5-T-10</b>	7	10	4	Terminal	1	7.200	<b>5098 41 3</b>

/pc.

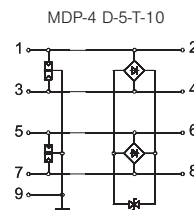

Maximum continuous operating voltage Vc/AC	V	7
Maximum continuous operating voltage Vc/DC	V	10
Lightning protection Zone LPZ		0-3
Number of poles		4
Rated current I <sub>L</sub>	A	10
Serial impedance per path	Ω	-
Impulse durability line-line		C1: 0.5 kV / 0.25 kA
Total Impulse durability (10/350)	kA	D1: 2
Total Impulse durability (8/20)	kA	10
Voltage protection level line-line	V	45
Voltage protection level line-earth	V	800
Shielding connection available		Yes
Shield connection		Direct
Temperature range θ	°C	-40 - +80
Connection cross-section, flexible	mm <sup>2</sup>	2.5
Connection cross-section, multi-wire	mm <sup>2</sup>	1.5
Connection cross-section, rigid	mm <sup>2</sup>	2.5
Testing standard		IEC 61643-21
<b>Item No.</b>		<b>5098 41 3</b>



# MCR protection for multi-wire systems (testable) to 10 A

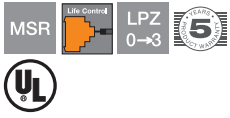

Testable data cable protection devices for multi-wire systems

- Narrow installation width of only 8 mm
- Low protection level for high current load
- Screwless terminals
- Bandwidth-optimised for secure transmission
- Quick mounting on hat rail or wall mounting
- Testable in installed state

Application: Measuring technology, switchgear cabinet construction, etc.



## Series protection device, 2-pole, 12 V version

Type	Max. continuous operating voltage Vc/AC V	Max. continuous operating voltage Vc/DC V	Number of poles	Connection system	Pack. pcs	Weight kg/100 pcs.	Item No.
<b>MDP-2 D-12-T-10</b>	10.5	15	2	Terminal	1	6.000	<b>5098 41 5</b>

/pc.

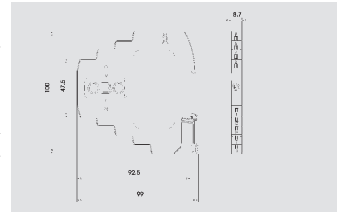

## Series protection device, 4-pole, 12 V version

Type	Max. continuous operating voltage Vc/AC V	Max. continuous operating voltage Vc/DC V	Number of poles	Connection system	Pack. pcs	Weight kg/100 pcs.	Item No.
<b>MDP-4 D-12-T-10</b>	10.5	15	4	Terminal	1	6.000	<b>5098 41 9</b>

/pc.

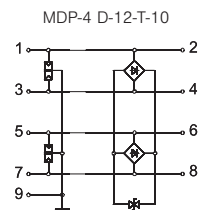
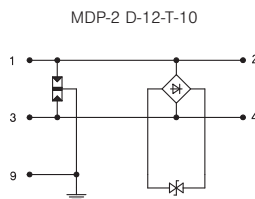
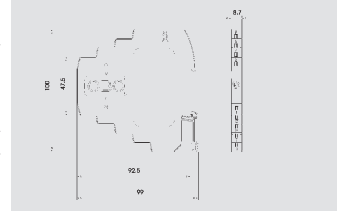

Maximum continuous operating voltage Vc/AC	V	10.5	10.5
Maximum continuous operating voltage Vc/DC	V	15	15
Lightning protection Zone LPZ		0-3	0-3
Number of poles		2	4
Rated current I <sub>L</sub>	A	10	10
Serial impedance per path	Ω	-	-
Impulse durability line-line		C1: 0.5 kV / 0.25 kA	
Total impulse durability (10/350)	kA	D1: 1	D1: 2
Total impulse durability (8/20)	kA	5	10
Voltage protection level line-line	V	55	55
Voltage protection level line-earth	V	800	800
Shielding connection available		Yes	Yes
Shield connection		Direct	Direct
Temperature range θ	°C	-40 - +80	-40 - +80
Connection cross-section, flexible	mm <sup>2</sup>	2.5	2.5
Connection cross-section, multi-wire	mm <sup>2</sup>	1.5	1.5
Connection cross-section, rigid	mm <sup>2</sup>	2.5	2.5
Testing standard		IEC 61643-21	IEC 61643-21
<b>Item No.</b>		<b>5098 41 5</b>	<b>5098 41 9</b>



# MCR protection for multi-wire systems (testable) to 10 A

Testable data cable protection devices for multi-wire systems

- Narrow installation width of only 8 mm
- Low protection level for high current load
- Screwless terminals
- Bandwidth-optimised for secure transmission
- Quick mounting on hat rail or wall mounting
- Testable in installed state

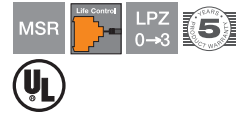

Application: Measuring technology, switchgear cabinet construction, etc.

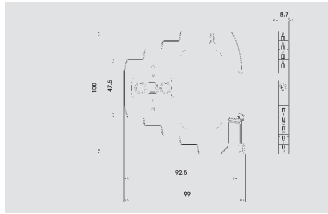

## Series protection device, 2-pole, 24 V version

Type	Max. continuous operating voltage Vc/AC V	Max. continuous operating voltage Vc/DC V	Number of poles	Connection system	Pack. pcs	Weight kg/100 pcs.	Item No.
<b>MDP-2 D-24-T-10</b>	20	28	2	Terminal	1	6.000	<b>5098 42 5</b>

/pc.

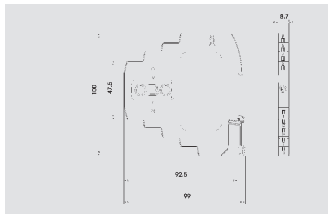

## Series protection device, 4-pole, 24 V version

Type	Max. continuous operating voltage Vc/AC V	Max. continuous operating voltage Vc/DC V	Number of poles	Connection system	Pack. pcs	Weight kg/100 pcs.	Item No.
<b>MDP-4 D-24-T-10</b>	20	28	4	Terminal	1	7.200	<b>5098 43 3</b>

/pc.



MDP-2 D-24-T-10

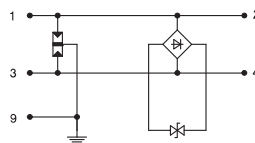

MDP-4 D-24-T-10

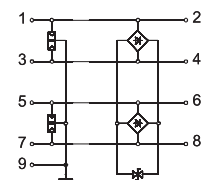

Maximum continuous operating voltage Vc/AC	V	20	20
Maximum continuous operating voltage Vc/DC	V	28	28
Lightning protection Zone LPZ		0→3	0→3
Number of poles		2	4
Rated current I <sub>L</sub>	A	10	10
Serial impedance per path	Ω	-	-
Impulse durability line-line		C1: 0.5 kV / 0.25 kA	C1: 0.5 kV / 0.25 kA
Total Impulse durability (10/350)	kA	D1: 1	D1: 2
Total Impulse durability (8/20)	kA	5	10
Voltage protection level line-line	V	70	70
Voltage protection level line-earth	V	800	800
Shielding connection available		Yes	Yes
Shield connection		Direct	Direct
Temperature range θ	°C	-40 - +80	-40 - +80
Connection cross-section, flexible	mm <sup>2</sup>	2.5	2.5
Connection cross-section, multi-wire	mm <sup>2</sup>	1.5	1.5
Connection cross-section, rigid	mm <sup>2</sup>	2.5	2.5
Testing standard		IEC 61643-21	IEC 61643-21
<b>Item No.</b>		<b>5098 42 5</b>	<b>5098 43 3</b>



# Accessories for MCR protection



## Accessories for series terminal

Type	Pack.	Weight	Item No.
	pcs	kg/100 pcs.	
<b>VB-MDP 10-MD</b>	1	2.300	<b>5098 47 0</b>

**Cu** Copper

Connecting bridge for 8 mm lightning barriers

- Length of bridge can be adjusted
- Material: Copper
- Allows quick equipotential bonding

Application: Parallel switching of the MDP lightning barriers

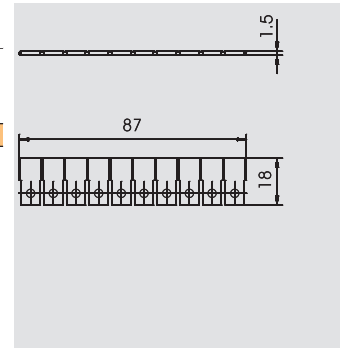

## Replacement connector for VF remote signalling

Type	Version	Pack.	Weight	Item No.
		pcs	kg/100 pcs.	
<b>VF-FS</b>	3-pole	25	0.320	<b>5098 47 5</b>

Replacement telephony connector, 3-pin version, for VF variant

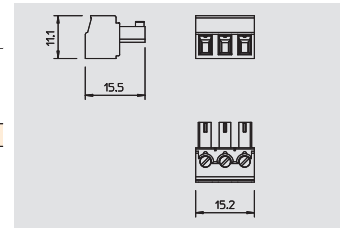

## MCR protection for explosive areas: the plus of the Petrol Field Protector family

- +For explosive areas
- +Two or three-pole protection of various sensors
- +Metric or NPT thread
- +Robust VA housing
- +High arresting capacity



In the Petrol Field Protector for data cable protection devices, OBO Bettermann can offer a surge protection device for sensors in potentially explosive areas. The Petrol Field Protector permits two or three-pole protection for all kinds of sensors. The protection device can be fastened directly on the sensor and wired in using the appropriate metric or NPT thread.

The robust VA housing means that aggressive atmospheres are no problem. The intrinsic safety of the Petrol Field Protector was independently tested and certified. The Petrol Field Protector is your partner for safety-relevant applications, in which effective surge protection must be guaranteed.



# MCR protection for explosive areas



Data cable protection devices for intrinsically-safe measuring circuits and bus systems

- Different connection systems available (metric/NPT)
- Low protection level at high current load
- Easy mounting on field devices
- Negligible internal capacitance and inductance
- Easy retrofitting

Application: Flow sensors, temperature sensors

## MCR protection for explosive areas, 2-pole, 24 V



Type	U max DC V	U max AC V	Version	Pack. pcs	Weight kg/100 pcs.	Item No.
<b>FDB-2 24-M</b>	32	22	2-pole; metric	1	18.500	<b>5098 38 0</b>

/pc.

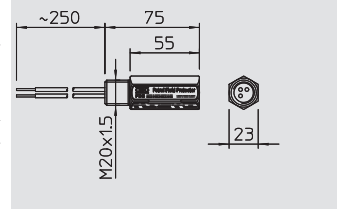

## MCR protection for explosive areas, 3-pole, 24 V



Type	U max DC V	U max AC V	Version	Pack. pcs	Weight kg/100 pcs.	Item No.
<b>FDB-3 24-M</b>	32	22	3-pole; metric	1	19.000	<b>5098 38 2</b>

/pc.

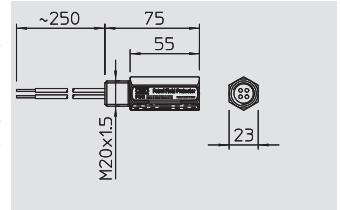

## MCR protection for explosive areas, 2-pole, 24 V



Type	U max DC V	U max AC V	Version	Pack. pcs	Weight kg/100 pcs.	Item No.
<b>FDB-2 24-N</b>	32	22	2-pole; NPT	1	19.000	<b>5098 39 0</b>

/pc.

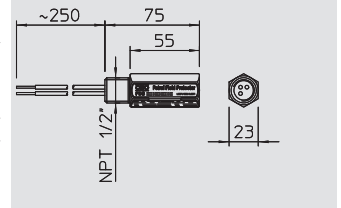

## MCR protection for explosive areas, 3-pole, 24 V



Type	U max DC V	U max AC V	Version	Pack. pcs	Weight kg/100 pcs.	Item No.
<b>FDB-3 24-N</b>	32	22	3-pole; NPT	1	19.500	<b>5098 39 2</b>

/pc.

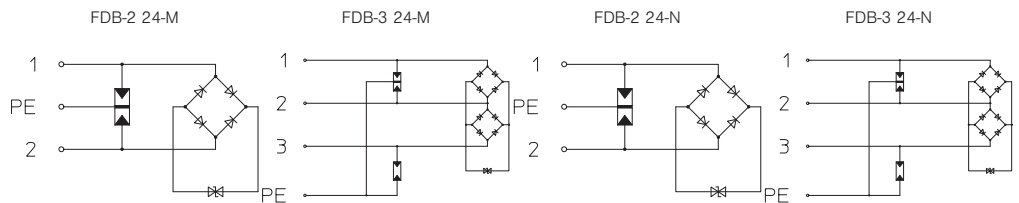
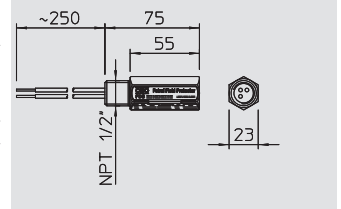

U max AC	U <sub>c</sub> AC	V	22	22	22	22
U max DC	U <sub>c</sub> DC	V	32	32	32	32
Total impulse durability into C2 (8/20)		kA	10	10	10	10
Impulse durability int C2 (wire-wire)		kA	0.25	0.25	0.25	0.25
Voltage protection level line-earth		V	< 850	< 850	< 850	< 850
Voltage protection level line-line		V	< 80	< 80	< 80	< 80
Temperature range	θ	°C	-20 - +70	-20 - +70	-20 - +70	-20 - +70
Signalling on device			None	None	None	None
Capacity (wire-wire)			< 27 pF	< 27 pF	< 27 pF	< 27 pF
Capacity (wire-earth)			< 27 pF	< 27 pF	< 27 pF	< 27 pF
Mounting of input / output			M20 x 1.5 external thread	M20 x 1.5 external thread	1/2" NPT	1/2" NPT
Mounting of field / device side:			Connection cable 1.5 mm <sup>2</sup> Length ~ 250 mm	Connection cable 1.5 mm <sup>2</sup> Length ~ 250 mm	Connection cable 1.5 mm <sup>2</sup> Length ~ 250 mm	Connection cable 1.5 mm <sup>2</sup> Length ~ 250 mm
Earthing via:			Connection cable	Connection cable	Connection cable	Connection cable
Housing material			V2A	V2A	V2A	V2A
Approval			ATEX	ATEX	ATEX	ATEX
<b>Item No.</b>			<b>5098 38 0</b>	<b>5098 38 2</b>	<b>5098 39 0</b>	<b>5098 39 2</b>





## MSR protection for Ex areas: the plus of the MDP Ex family

- +Protection device for multi-wire systems (4-pole)
- +Direct shield earthing
- +Easy-mounting, screwless connection option
- +Space-saving width of just 8.1 mm
- +Ex-tested for intrinsically-safe measuring circuits
- +High frequency bandwidth up to 100 MHz



Surge protection in potentially explosive areas is an important topic. Here, it is important to protect costly measuring technology against the influence of surge voltages through atmospheric discharge. OBO lightning barriers are tested for intrinsic safety (ia) and

are independently certified. With a high arresting capacity of 10 kA, they offer optimum protection for four-pole measurement and control applications. Different voltage variants offer a wide range of applications.



# MCR protection for explosive areas



MDP.../D...-EX : Lightning barrier for intrinsically-safe measuring circuits

- Protection device for multi-wire systems
- Direct shield earthing
- With easy-to-mount, screwless connection terminals
- Space-saving width of just 8.1 mm
- Ex-tested for intrinsically-safe measuring circuits
- High bandwidth up to 100 MHz

Application: universal use on 35 mm hat profile rail in any standard distribution housing.



## Series protection device, 4-pole, 5 V version, Ex-tested

Type	Max. continuous operating voltage Vc/AC V	Max. continuous operating voltage Vc/DC V	Number of poles	Pack. pcs	Weight kg/100 pcs.	Item No.
<b>MDP-4 D-5-EX</b>	7	10	4	1	5.800	<b>5098 41 2</b>

/pc.

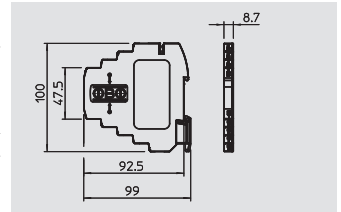

## Series protection device, 4-pole, 24 V version, Ex-tested

Type	Max. continuous operating voltage Vc/AC V	Max. continuous operating voltage Vc/DC V	Number of poles	Pack. pcs	Weight kg/100 pcs.	Item No.
<b>MDP-4 D-24-EX</b>	20	28	4	1	5.800	<b>5098 43 2</b>

/pc.

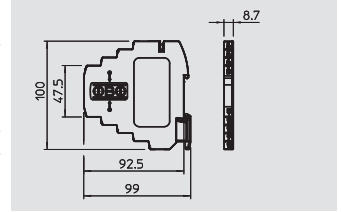

## Series protection device, 4-pole, 48 V version, Ex-tested

Type	Max. continuous operating voltage Vc/AC V	Max. continuous operating voltage Vc/DC V	Number of poles	Pack. pcs	Weight kg/100 pcs.	Item No.
<b>MDP-4 D-48-EX</b>	41	58	4	1	5.800	<b>5098 45 2</b>

/pc.

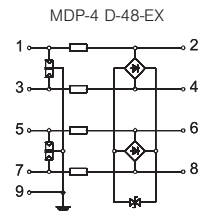
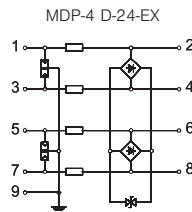
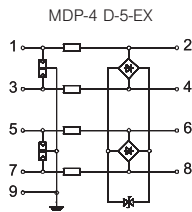
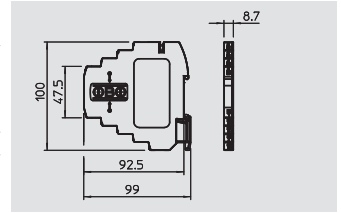





Maximum continuous operating voltage Vc/AC	V	7	20	41
Maximum continuous operating voltage Vc/DC	V	10	28	58
Lightning protection Zone LPZ		1→3	1→3	1→3
Number of poles		4	4	4
Rated current I <sub>L</sub>	A	0.58	0.58	0.58
Serial impedance per path	Ω	2,35 ± 5 %	2,35 ± 5 %	2,35 ± 5 %
Impulse durability line-line		C1: 0.5 kV / 0.25 kA	C1: 0.5 kV / 0.25 kA	C1: 0.5 kV / 0.25 kA
Impulse durability line-earth		C2: 5 kV / 2,5 kA	C2: 5 kV / 2,5 kA	C2: 5 kV / 2,5 kA
Total Impulse durability (10/350)	kA	D1: 2kA	D1: 2	D1: 2
Total Impulse durability (8/20)	kA	10 kA	10 kA	10
Voltage protection level line-line	V	35 V	55	95
Voltage protection level line-earth	V	800 V	800	800
Shielding connection available		Yes	Yes	Yes
Shield connection		Direct	Direct	Direct
Temperature range θ	°C	-40 - +80	-40 - +80	-40 - +80
Connection cross-section, flexible	mm <sup>2</sup>	2.5	2.5	2.5
Connection cross-section, multi-wire	mm <sup>2</sup>	1.5	1.5	1.5
Connection cross-section, rigid	mm <sup>2</sup>	2.5	2.5	2.5
Ex approval		Ex II 2(1) G Ex ia IIC T4	Ex II 2(1) G Ex ia IIC T4	Ex II 2(1) G Ex ia IIC T4
Testing standard		IEC 61643-21	IEC 61643-21	IEC 61643-21
<b>Item No.</b>		<b>5098 41 2</b>	<b>5098 43 2</b>	<b>5098 45 2</b>







## Directories

	Alphabetical table of contents	398
	Numeric directory	404
	Type listing	408
	Terms and conditions of sale and delivery	419



# Alphabetical table of contents

## A

Accessories for series terminal, 280  
Adapter for flat roof cable holder, 390  
Adjustable insulating beam – pipe, 386  
Adjustable insulating beam – wall, 386  
Angler spreading anchor, 378  
Articulated connector, 384

## B

Base for FangFix Junior, 332  
Base for FangFix system 10 kg, 334, 385  
Base for FangFix system 16 kg, 333, 384  
Base for FangFix system 16 kg for mounting the, 338, 392  
isFang tripod  
Base plate, 351  
Base, Multibase, 165, 196, 205  
Base, Multibase + NPE, 165, 196, 205  
Base, Multibase + NPE with fuse monitoring, 166, 197, 206  
Base, Multibase + NPE with remote signalling, 165, 196, 205  
Base, Multibase with acoustic signalling, 166, 197, 206  
Base, Multibase with fuse monitoring, 165, 196, 205  
Base, Multibase with remote signalling, 165, 196, 205  
Basic protection for 4-wire information technology, 252  
systems with RJ45  
Basic protection for two-core systems with HF, 265  
applications 120 V  
Bi-metal roof gutter clamp for all bead thicknesses, 366  
Bi-metal separating piece for Rd 8–10 and FL 30 mm, 373  
Bi-metal separating piece for Rd 8–10 and FL 30–40, 374  
mm  
Bonding base, 348  
Bonding base including industrial bonding pad, 348  
BP earthing rod, 312  
BP earthing rod with copper sheath, 313  
Bridging cable, 369

## C

Cable bracket for flat conductor, 324  
Cable bracket for Rd 8–10 and FL 30, 324  
Cable bracket with crossbar FL 30 mm, with round, 350  
pin  
Cable bracket with crossbar FL, 30 mm mounting, 350  
height  
Cable bracket with crossbar Rd 8–10 mm, 349  
Cable bracket with crossbar Rd 8–10 mm, with, 350  
square pin  
Cable bracket with crossbar Rd 8–10 mm, with wood, 351  
screw thread  
Cable bracket with hinged crossbar Rd 8–10 mm, 349  
Cable bracket with hinged crossbar Rd 8–10, 30 mm, 349-350  
mounting height  
Cable bracket, Rd 8–10 mm with bonding base, 348  
Card reader PCS-CS..., 293  
Clamp lock for strip earthing clip, 303  
Clamp clips for screen connection, 306  
Clamping block for Rd 16 mm, 353  
Clamping block for Rd 8-10 mm, 352  
Clamping shoe, 367  
Clip branch terminal, 306  
Closed spark gap with lightning current carrying, 288  
capability  
Coaxial protection device for 7/16 connection:, 247  
male/female  
Coaxial protection device for BNC connection:, 245  
female/female  
Coaxial protection device for BNC connection:, 245  
male/female  
Coaxial protection device for BNC connection:, 246  
male/male  
Coaxial protection device for F connection:, 247  
female/female  
Coaxial protection device for F connection:, 247  
male/female

## C

Coaxial protection device for N connection:, 246  
female/female  
Coaxial protection device for N connection:, 246  
male/female  
Coaxial protection device for SAT and cable, 248  
multiswitch  
Coaxial protection device for SMA connection:, 247  
female/female  
Coaxial protection device for TNC connection:, 246  
male/female  
Coaxial protection devices for S-UHF connection:, 245  
female/female  
Coaxial protection devices for S-UHF connection:, 245  
male/female  
CombiController V50 base, 152  
CombiController V50 base with remote signalling, 152  
Combination arrester for 10Base2-/10Base5, 250  
networks  
Combination arrester for 4-wire information, 252  
technology systems with RJ45  
Combination arrester upper part, 142  
Combination arrester upper part 280 V, 163  
Combination arrester upper part 320 V, 163  
Combination arrester upper part 385 V, 163  
Combination arrester upper part 150 V, 163  
Combination arrester upper part 150 V, 151  
Combination arrester upper part 280 V, 151  
Combination arrester, 1-pole, 137, 155, 158, 162  
Combination arrester, 1-pole + NPE, 154, 156  
Combination arrester, 1-pole + NPE with remote, 157  
signalling  
Combination arrester, 1-pole NPE, 136, 156  
Combination arrester, 1-pole with function display, 137  
Combination arrester, 2-pole, 155, 158, 162  
Combination arrester, 2-pole + NPE, 156  
Combination arrester, 3-pole, 137, 158, 162  
Combination arrester, 3-pole + NPE, 136, 154, 156, 161  
Combination arrester, 3-pole + NPE with function, 136  
display  
Combination arrester, 3-pole + NPE with remote, 157, 161  
signalling  
Combination arrester, 3-pole + NPE, with acoustic, 157, 161  
signalling  
Combination arrester, 3-pole with function display, 137  
Combination arrester, 3-pole with remote signalling, 159  
Combination arrester, 3-pole, with acoustic signalling, 159  
Combination arrester, 4-pole, 158, 162  
Combination arrester, 4-pole in housing with remote, 160  
signalling  
Combination arrester, 4-pole with remote signalling, 159  
Combination arrester, 4-pole, with acoustic signalling, 159  
Combination arrester, 4-pole, with voltage monitoring, 160  
Combination protection device for ISDN, 237  
Combination protection device for ISDN and DSL, 237  
systems  
Combination protection device for ISDN bus side, 239  
Combination protection device for ISDN RJ11, 238  
Combination protection device for ISDN RJ45, 238  
Combination protection for two-core systems with HF, 265  
applications 24 V  
Combination protection for two-core systems with HF, 265  
applications 5 V  
Complete photovoltaic block V20, 1000 V DC, 223  
Complete photovoltaic block V20, 1000 V DC with IR, 223  
Complete photovoltaic block V20, 600 V DC, 222  
Complete photovoltaic block V20, 600 V DC with IR, 222  
Complete photovoltaic block V25, 900 V DC, 221  
Complete photovoltaic block V25, 900 V DC with IR, 221  
Complete photovoltaic block V50, 600 V DC, 220  
Complete photovoltaic block V50, 600 V DC with IR, 220  
Concrete block for FangFix system 10 kg, 334, 384  
Concrete block for FangFix-System 16 kg, 333, 338, 384, 392  
Connecting bridge, 143

**C**

Connecting bridge for V10 Compact 200 mm, 201  
 Connecting bridge for V10 Compact 400 mm, 201  
 Connecting bridge, Multibase base, 164  
 Connection and bridging component, 369  
 Connection and end piece, 358  
 Connection and end piece with connector, 358  
 Connection and end piece with connector and, 358  
 pressure trough  
 Connection and end piece, DIN version, 358  
 Connection and expansion strip, 369  
 Connection clip, 374  
 Connection clip for earthing rod on flat conductor, 318  
 Connection clip for earthing rod or cables, 318  
 Connection clip for earthing rod to round cables Rd, 318  
 8-10  
 Connection clip for earthing rod, universal, 318  
 Connection component, 369  
 Connection element, 388  
 Connection element for installation in the insulated, 391  
 interception rod isFang IN  
 Connection joint, 384  
 Connection piece, 383  
 Connection plate for one isCon® cable, 392  
 Connection plate for two isCon® cables, 392  
 Connection strap for Parex spark gap, 288  
 Connection terminal for reinforced steels, 322  
 Connection terminal for round cable, 322  
 Connection terminal to 14 mm, 363  
 Connection terminal, equipotential bonding, Rd 16, 306, 368  
 mm  
 Connection terminal, equipotential bonding, Rd 8-10, 305, 367  
 mm  
 Connector Rd 8-10 mm, double, 356  
 Connector Rd 8-10 mm, single, 356  
 Connector Rd 8-10 mm, triple, 357  
 Connector, Rd 8-10 mm with M10 thread, 356  
 Connector, Rd 8-10 mm with pressure trough, 357  
 Connector, Rd 8-10 mm, double, with pressure, 357  
 trough  
 Construction clamp to 20 mm, 363  
 Contact strip for 1801 VDE, 297  
 Copper bridges with step width 17.6 mm, 206  
 Copper bridges with step width 53.4 mm, 206  
 Copper flat conductor, 310  
 Cover for BigBar equipotential bonding rail, 301  
 Cover hood for 1801 VDE, 297  
 Cover hood for 1809, 298  
 Crossbar for equipotential bonding rail, 301  
 Crossbar for Rd 8-10 mm, 351  
 Crossbar, round cables and interception rods 16 mm, 353  
 Cross-connector for flat conductor, 319  
 Cross-connector for flat conductor, with intermediate, 319  
 plate  
 Cross-connector for flat conductors and round cables, 321  
 Cross-connector for Rd 8-10 x Rd 16 mm, 362  
 Cross-connector for round cables and flat conductors, 360  
 Cross-connector for round cables and flat conductors, 360  
 DIN  
 Cross-connector for round cables Rd 8-10, 319  
 Cross-connector for round cables Rd 8-10 x Rd 16, 320  
 Cross-connector Rd 8-10 mm, 361  
 Cross-connector Rd 8-10 mm, wide version, 361  
 Cross-connector with intermediate plate for Rd 8-10, 361  
 mm  
 Cross-connector with intermediate plate for Rd 8-10, 361-362  
 mm, wide version  
 Cross-connector with intermediate plate for Rd 8-10, 362  
 x Rd 16 mm  
 Cross-connector with intermediate plate for round, 320  
 cables, Rd 8-10

**C**

Cross-connector with intermediate plate for round, 320  
 cables, Rd 8-10 x Rd 16

**D**

Data cable protection device for coaxial TV / camera, 251  
 systems  
 Decoupling inductivity, 143  
 Diagonal clamp, 321  
 Diagonal clamp with bolt, 321  
 DIN cross-connector for flat conductor, 319  
 DIN cross-connector for flat conductor, with, 319  
 intermediate plate  
 Directional irons, 378  
 DK connector, 383  
 Double connection terminal, equipotential bonding,, 368  
 Rd 8-10 mm  
 Downspout clip, 370  
 Downspout clip for routing Rd 8-10 mm behind pipe, 370-371

**E**

Earth connection terminal for round cable and flat, 306  
 conductor  
 Earth entry rod with separating piece and connector, 316, 375  
 Earth entry rod, tapered and partially insulated, 316, 375  
 Earthing clip, type 925, 304  
 Earthing clip, type 942, 304  
 Earthing clip, type 952, 305  
 Earthing connection block, 323  
 Earthing fixed point, 322  
 Earthing plate, 317  
 Earthing rod for standard applications, 312  
 Earthing screw with fastening thread, 306  
 Earthing strap, type 950, 304  
 Earthing terminal for cables and flat conductors, 306  
 Earthing terminal for fastening on earthing strap, 304  
 Earthing terminal type 951, 305  
 Empty housing for arrestors, 164  
 End piece, 322-323, 368, 383  
 Equipotential bonding bar for bathroom, 299  
 Equipotential bonding rail BigBar for industrial, 301  
 application  
 Equipotential bonding rail for indoors, VDE-tested, 296  
 Equipotential bonding rail for outside installation, 300  
 Equipotential bonding rail for small systems, 298  
 Equipotential bonding rail with metal base plate, 298  
 Equipotential bonding rail with plastic base plate, 297  
 Equipotential bonding rail, simple version, 299  
 Equipotential bonding rail, solid version, 298  
 Expansion piece, 323, 369  
 Explosion-proof, closed spark gap, 288  
 Extension, 384

**F**

FangFix reducing sleeve, 384  
 Fastening bolt, 385  
 Fastening plate, 385  
 Fastening set for hat profile rail, 251  
 Fine power protection / adapter with cold device, 211  
 connector  
 Fine power protection / dado duct installation Modul, 213  
 45  
 Fine power protection / socket bar, 211  
 Fine power protection for all installation systems, 212  
 Fine power protection for through wiring, 212  
 Fine power protection with holder for GB2 and GB3, 212  
 mounting boxes  
 Fine protection device for ISDN RJ11, 238  
 Fine protection device for ISDN RJ45, 238  
 Fine protection for 10Base2-/10Base5 networks, 250  
 Fine protection for 15-pin RS232 interface, 255

## Alphabetical table of contents

### F

Fine protection for 25-pin RS232 interface, 255  
Fine protection for 25-pin RS485 interface, 256  
Fine protection for 4-wire information technology, 253 systems RJ45  
Fine protection for 4-wire information technology, 252 systems with RJ45  
Fine protection for 8-wire information technology, 253 systems RJ45  
Fine protection for 9-pin RS232 interface, 255  
Fine protection for 9-pin RS485 interface, 256  
Fine protection for Ethernet networks (Class D/CAT, 250 5)  
Fine protection for RS232 with screwless terminals, 257  
Fine protection for RS485 with screwless terminals, 257  
FineController for ISDN telephone systems and, 211 terminals  
FineController for protective contact socket, 210  
FineController for SAT systems and receivers, 210  
FineController for telephone systems and terminals, 210  
FineController for telephone systems with RJ11, 211  
FineController for video, TV and HiFi systems, 210  
Flat conductor adapter for roof cable holder, type, 345 165/MBG  
Flat conductor terminal from FL 30 for 1801 VDE, 297  
Flat conductor terminal to FL 30 for 1801 VDE, 296  
Flat conductor, copper, 330  
Flat lead, 377  
Fold fastening, 385  
Folding and construction clamp, 10–20 mm, 362  
Folding clamp and connection terminal up to 10 mm, 365 plate thickness  
Folding clamp Rd 8-10 up to 10 mm plate thickness, 363-364  
Folding clamp up to 10 mm plate thickness, 363-364  
Folding clamp up to 5 mm plate thickness, 364

### G

Galvanised steel flat conductor, 310  
Galvanised steel flat conductor for earth, 330  
Gutter clamp for all bead thicknesses, 365-366  
Gutter clamp for bead thickness 15–22 mm, 366  
Gutter clamp RK-FIX, 365

### H

Hammer insert for LightEarth earthing rod, 315  
Hammer insert, type 2500, for earthing rods ST, BP, 314 and OMEX  
Hammer insert, type 2510, for earthing rods ST, BP, 314 and OMEX  
Hammer insert, type 2520, for earthing rods ST, BP, 314 and OMEX  
Hammer insert, type 2530, for earthing rods ST, BP, 314 and OMEX  
Hammer insert, type 2531, for earthing rods ST, BP, 314 and OMEX  
Hammer insert, type 2535, for earthing rods ST, BP, 315 and OMEX  
Hammer insert, type 2536, for earthing rods ST, BP, 315 and OMEX  
Hinge crossbar for FL 30 mm, 351  
Hinge crossbar for Rd 8-10 mm, 351  
Holder for installation in GB2 and GB3 mounting, 212 boxes  
Holder, V support, 385

### I

Impact head for earthing rods ST, BP and OMEX, 314  
Impact head for LightEarth earthing rod, 313  
Impact point for LightEarth earthing rod, 313  
Impact point for OMEX earthing rod, 313  
Impact point for ST and BP earthing rod, 313  
Inspection door, 376  
Installation strip for strip earthing clip, 303

### I

Insulated interception rod, 337, 391  
Insulated interception rod for inner-routed isCon cable, 338, 393  
Insulated interception rod for inner-routed isCon cable, 337, 390 with side exit  
Insulated lightning protection set, 3-corner fastening, 382  
Insulated lightning protection set, IR fastening, 382  
Insulated lightning protection set, V fastening, 382  
Insulated lightning protection set, VRS fastening, 382  
Insulated spacer, 387  
Insulating rod, 382  
Insulation removal pliers, 388  
Interception rod for FangFix-Junior, 332  
Interception rod holder for ridge tiles, 336  
Interception rod holder for sloping roof, 335  
Interception rod, one end rounded, 334  
Interception rod, one end rounded with connection, 334 strap  
Interception tip, 332, 386  
Interception/earth entry rod with connection tabs, 316, 335, 375  
Interception/earth entry rod with connection tabs and, 335 connector  
Interception/earth entry rod, rounded-off on both, 315, 332-333, 375 sides  
isCon® arrestor, 388  
isCon® arrestor in light grey, 388  
isFang interception rod, 337  
isFang interception rod stand, 337, 391  
isFang interception rod stand with side exit, 337, 391  
isFang support for corner pipe mounting, 50 x 50 mm, 339  
isFang support for pipe mounting, ø 40–50 mm, 339, 394  
isFang support for pipe mounting, ø 50–300 mm, 339, 393  
isFang support for pipe mounting, ø 50–60 mm, 339  
isFang support for spaced pipe mounting, ø 50–300, 339, 394 mm  
isFang support for wall mounting, 15 mm spacing, 338, 393  
isFang support for wall mounting, 200–300 mm, 338, 393 spacing  
isFang support for wall mounting, 80 mm spacing, 338, 393  
isFang-3B threaded rod, 338, 392  
ISOLAB measuring system arrestor tester, 292

### K

K connector, 383

### L

LightEarth earthing rod, 312  
Lightning arrestor/combo arrestor base, 143  
Lightning current and surge arrestor, 1-pole + NPE, 148  
Lightning current and surge arrestor, 1-pole + NPE, 149 with remote signalling  
Lightning current and surge arrestor, 2-pole + NPE, 148  
Lightning current and surge arrestor, 3-pole, 150  
Lightning current and surge arrestor, 3-pole + NPE, 148  
Lightning current and surge arrestor, 3-pole + NPE, 149 with remote signalling  
Lightning current and surge arrestor, 3-pole with, 150 remote signalling  
Lightning current and surge arrestor, 4-pole, 150  
Lightning current and surge arrestor, 4-pole with, 150 remote signalling  
Lightning current arrestor, 1-pole, 141  
Lightning current arrestor, 1-pole NPE, 140  
Lightning current arrestor, 1-pole with function display, 141  
Lightning current arrestor, 3-pole, 141  
Lightning current arrestor, 3-pole + NPE, 140  
LSA-Plus technology / LSA basic protection, 241  
LSA-Plus technology / LSA connection strip, 241  
LSA-Plus technology / LSA earthing rail for LSA-BF, 242  
LSA-Plus technology / LSA earthing strip, 241  
LSA-Plus technology / LSA installation trough, 242  
LSA-Plus technology / LSA separating strip, 241  
LSA-Plus technology / LSA simple tool, 243



**L**

LSA-Plus technology / protective housing, 243  
 LSA-Plus technology/LSA basic and fine protection, 242

**M**

Magnetic card and holder, 376  
 Magnetic card and holder MK-B, 293  
 Magnetic card holder, 377  
 Magnetic card holder PCS-H, 293  
 Magnetic card PCS, 293, 376  
 Magnetic card reader, 377  
 Malleable iron separating piece, 374  
 MCR protection for 2-pin for power supply with leak, 217, 263  
 current-free remote signalling, 110 V AC/DC  
 MCR protection for 2-pin for power supply with leak, 217, 263  
 current-free remote signalling, 230 V AC/DC  
 MCR protection for 2-pin for power supply with leak, 217, 263  
 current-free remote signalling, 24 V AC/DC  
 MCR protection for 2-pin for power supply with, 216, 262  
 remote signalling, 110 V AC/DC  
 MCR protection for 2-pin for power supply with, 261  
 remote signalling, 12 V AC/DC  
 MCR protection for 2-pin for power supply with, 216, 262  
 remote signalling, 230 V AC  
 MCR protection for 2-pin for power supply with, 216, 261  
 remote signalling, 24 V AC/DC  
 MCR protection for 2-pin for power supply with, 261  
 remote signalling, 48 V AC/DC  
 MCR protection for 2-pin for power supply with, 262  
 remote signalling, 60 V AC  
 MCR protection for 2-pin for power supply, 110 V, 215, 260  
 MCR protection for 2-pin for power supply, 12 V, 214, 259  
 MCR protection for 2-pin for power supply, 230 V, 215, 260  
 MCR protection for 2-pin for power supply, 24 V, 214, 259  
 MCR protection for 2-pin for power supply, 48 V, 214, 259  
 MCR protection for 2-pin for power supply, 60 V, 214, 259  
 MCR protection for explosive areas, 2-pole, 24 V, 282  
 MCR protection for explosive areas, 3-pole, 24 V, 282  
 Medium and fine protection for two-core systems 110, 267, 270,  
 V 272  
 Medium and fine protection for two-core systems 12, 266, 269,  
 V 271  
 Medium and fine protection for two-core systems 24, 266, 268-  
 V 269, 271  
 Medium and fine protection for two-core systems 48, 266, 269,  
 V 271  
 Medium and fine protection for two-core systems 5 V, 266, 268-  
 269, 271  
 Medium and fine protection for two-core systems 60, 270  
 V  
 M-Quick cable bracket PA, 390  
 Multi-Adapter, 386  
 Multibase MB25 base, 191  
 Multibase MB25 base with remote signalling, 191  
 Mushroom-shaped interceptor with connectors, 336

**N**

Number plates, 326, 374

**O**

OMEX earthing rod, 313

**P**

PA cable bracket with tightening strap, 389  
 PA roof cable holder, sloping roof, 390  
 Parallel clamp, 322  
 Parallel connector Rd 8 mm, M10 x 30, 359  
 Parallel connector Rd 8–10 mm, M6 x 20, 359  
 Parallel connector Rd 8–10 mm, M8 x 25, 358  
 Photovoltaic housing 600 V DC with connection, 227  
 terminals with IR  
 Photovoltaic housing 900 V DC with connection, 227  
 terminals with IR

**P**

Photovoltaic housing for inverter with 2 MPP trackers,, 224  
 type 1+2, 900 V DC  
 Photovoltaic housing for inverter with 2 MPP trackers,, 224  
 type 2, 1000 V DC  
 Photovoltaic housing for inverter with 2 MPP trackers,, 230  
 unequipped  
 Photovoltaic housing for inverter with 3 MPP trackers,, 224  
 type 1+2, 900 V DC  
 Photovoltaic housing for inverter with 3 MPP trackers,, 224  
 type 2, 1000 V DC  
 Photovoltaic housing for inverter with 3 MPP trackers,, 230  
 unequipped  
 Photovoltaic housing with 4 fuses, 225  
 Photovoltaic housing with 6 fuses, 225  
 Photovoltaic housing with connection terminals, type, 226  
 1+2, 600 V DC  
 Photovoltaic housing with connection terminals, type, 226  
 1+2, 900 V DC  
 Photovoltaic housing with connection terminals, type, 226  
 2, 1000 V DC  
 Photovoltaic housing with connection terminals,, 230  
 unequipped  
 Photovoltaic housing with MC 4 connector,, 230  
 unequipped  
 Photovoltaic housing with V-Tec entry, 228  
 Photovoltaic system solution, type 1+2, with MC, 229  
 connector, 600 V DC  
 Photovoltaic system solution, type 1+2, with MC, 229  
 connector, 900 V DC  
 Photovoltaic system solution, type 2, with MC, 229  
 connector, 1000 V DC  
 Photovoltaic system solution, type 2, with MC, 229  
 connector, 600 V DC  
 Photovoltaic upper part– lightning and surge arrestors, 231  
 Photovoltaic upper part– surge arrestors, 231  
 Photovoltaic upper part – lightning and surge, 231  
 arrestors  
 Photovoltaic upper part – surge arrestors, 231  
 Pipe clamp, 371  
 Pipe fastening, 385  
 Plastic corrosion protection strip, 326, 377  
 Potential and earth connection block, 302  
 Potential connection, 388  
 Potential connection clip for mounting on isFang, 392  
 Potential connection for installation in the insulated, 391  
 interception rod isFang IN  
 Profile earthing rod connection with connecting lug, 316  
 Profile earthing rod connection with round cable lug, 317  
 Profile rail, 306  
 Profile earthing rod connection with strip steel lug, 316  
 Protection package, SAT applications, 207  
 Protection package, telecommunications, 207  
 Protection package, TV, 207  
 Protection set MCD + V20 1-pole + NPE, 167  
 Protection set MCD + V20 3-pole, 168  
 Protection set MCD + V20 3-pole + NPE, 167  
 Protection set MCD + V20 3-pole + NPE with remote, 167  
 signalling  
 Protection set MCD + V20 3-pole with remote, 168  
 signalling  
 Protection set MCD + V20, leakage current-free, 3-, 170  
 pole  
 Protection set MCD + V20, leakage current-free, 3-, 169  
 pole + NPE  
 Protection set MCD + V20, leakage current-free, 3-, 169  
 pole + NPE with remote signalling  
 Protection set MCD + V20, leakage current-free, 3-, 170  
 pole with remote signalling  
 Protective spark gap, 289  
 PV base, 2-pole in Y circuit, 232  
 PV base, 2-pole in Y circuit with remote signalling, 232  
 PV base, 3-pole in Y circuit, 232  
 PV base, 3-pole in Y circuit with remote signalling, 232

## Alphabetical table of contents

### R

Rail stands for 1801 VDE, 297  
Remote signalling replacement connector for, 164, 197  
Multibase  
Replacement connector for VF remote signalling, 280  
Ridge conductor holder with tensioning spring, 340  
Rod clamp, 374  
Rod holder, 386  
Rod holder for 16 mm interception and earth entry, 352  
rods  
Rod holder for 16 mm interception and earth entry, 353  
rods, with square pin  
Rod holder for 16 mm interception and earth, 353  
entry rods, with screw and anchor  
Rod holder for 20 mm rods, 353-354  
Roof cable holder for flat roofs, 345  
Roof cable holder for flat roofs, plastic sleeve, 345  
Roof cable holder for flat roofs, recyclable, 346  
Roof cable holder for flat roofs, with increased base, 345  
section  
Roof cable holder for flat roofs, with raised cable, 346  
bracket  
Roof cable holder for flat roofs, without base, 345  
Roof cable holder for ridge tiles with M8 threaded, 341  
bolts  
Roof cable holder for ridge tiles, 180–240 mm, Rd, 341  
8–10  
Roof cable holder for ridge tiles, 185–260 mm, Rd 8, 340  
Roof cable holder for ridge tiles, 185–260 mm, Rd, 340-341  
8–10  
Roof cable holder for slated roofs with M8 threaded, 344  
bolts  
Roof cable holder for slated roofs, crimped, Rd 8, 342-343  
Roof cable holder for slated roofs, crimped, Rd 8–10, 343  
Roof cable holder for slated roofs, Rd 8, 343  
Roof cable holder for slated roofs, Rd 8–10, 343  
Roof cable holder for tiled and slated roofs, 74 mm, 344  
height  
Roof cable holder for tiled and slated roofs, Rd 8–10, 343  
Roof cable holder for tiled roofs, angled, flexible, Rd, 342  
8  
Roof cable holder for tiled roofs, angled, Rd 8, 342  
Roof cable holder for tiled roofs, angled, Rd 8–10, 342  
Roof cable holder for tiled roofs, Rd 8, 341  
Roof cable holder for tiled roofs, Rd 8–10, 341-342  
Roof cable holder for tiled, slated and corrugated, 344  
roofs, Rd 8  
Roof cable holder for tiled, slated and corrugated, 344  
roofs, Rd 8–10  
Roof cable holder for tiled, slated and corrugated, 344  
roofs, with cable bracket  
Roof cable holder for tiled, slated and corrugated, 344  
roofs, with crossbar  
Roof cable holder, 55 mm, suitable for bonding, 346  
straight to flat roofs  
Roof cable holder, suitable for bonding straight to flat, 346  
roofs  
Roof gutter clamp for all bead thicknesses, 366  
Roof penetration, 336  
Round cable terminal from 25 mm<sup>2</sup> for 1801 VDE, 296  
Round cable terminal to 25 mm<sup>2</sup> for 1801 VDE, 296  
Round cable, aluminium, 311, 331  
Round cable, aluminium with PVC sheathing, 331  
Round cable, aluminium, with PVC sheathing, 311  
Round cable, copper, 311, 331  
Round cable, galvanised steel, 310, 330  
Round cable, galvanised steel with PVC jacketing, 310, 330  
Round cable, stainless steel, 311, 331

### S

Screw-in anchor with M6 thread, 378  
Screw-in anchor with M8 thread, 378  
Screwless cable bracket for Rd 8 mm, fastening with, 347  
screw and anchor

### S

Screwless cable bracket for Rd 8 mm, through-way Ø, 347  
5 mm  
Screwless cable bracket for Rd 8 mm, through-way Ø, 347  
7 mm  
Screwless cable bracket, raised construction type, for, 347  
Rd 8 mm, through-way Ø 5 mm  
Separating piece for Rd 8–10 and FL 30 mm, 373  
Separating piece for Rd 8–10 and FL 30–40 mm, 373  
Separating piece, closed, 372  
Separating piece, open, 372  
Series protection device, 2-pole, 12 V version, 278  
Series protection device, 2-pole, 24 V version, 275, 279  
Series protection device, 2-pole, 48 V version, 276  
Series protection device, 2-pole, 5 V version, 274  
Series protection device, 3-pole, 24 V version, 275  
Series protection device, 3-pole, 48 V version, 276  
Series protection device, 3-pole, 5 V version, 274  
Series protection device, 4-pole, 12 V version, 278  
Series protection device, 4-pole, 24 V version, 275, 279  
Series protection device, 4-pole, 24 V version, Ex-, 284  
tested  
Series protection device, 4-pole, 48 V version, 276  
Series protection device, 4-pole, 48 V version, Ex-, 284  
tested  
Series protection device, 4-pole, 5 V version, 274, 277  
Series protection device, 4-pole, 5 V version, Ex-, 284  
tested  
Shock Guard for Multibase base, 164  
Shock Guard locking, 206  
Snow catching grate clamp, 367  
Spacer, 323, 390  
Spacer clip for flat conductor with fastening hole Ø, 324  
6.5  
Spacer clip for flat conductor, with fastening hole Ø 7, 324  
Spacer clip for flat conductor, with polyamide base, 324  
Spacer clip for flat conductor, with square pin, 325  
Spacer clip for flat conductor, with steel spreading, 325  
anchor Ø 10  
Spacer clip for flat conductor, with threaded, 324  
connection M6  
Spacer clip for flat conductor, with wood screw and, 325  
spacer  
Spare blade, 388  
Spark gap / surge voltage protection for coupling, 289  
earthing systems  
Stainless steel flat conductor, 310, 330  
Stand 16 kg with female thread, 335, 383  
Stand 6.9 kg with female thread, 335, 383  
Stand for FangFix Junior system, 332  
Stand for FangFix system 10 kg, 333  
Stand for FangFix system 16 kg, 333  
starQuick anchor M6, 389  
starQuick cable bracket PA, 389  
starQuick nut M6, 389  
Straight connector Rd 8 mm, 359  
Straight connector Rd 8–10 mm, 359  
Strip clip for fastening the isCon® cable to insulated, 393  
interception rods  
Strip earthing clip VA, 303  
Strip earthing clip, nickel-plated, 303  
Strip steel crimp, 326  
Surge arrester Compact 150 V, 200  
Surge arrester Compact 280 V, 200  
Surge arrester Compact 385 V, 200  
Surge arrester Compact with acoustic signalling, 200  
Surge arrester, 1-pole, 178, 181, 186, 188  
Surge arrester, 1-pole + NPE, 176, 179, 185, 202  
Surge arrester, 1-pole + NPE with remote signalling, 180  
Surge arrester, 1-pole NPE, 179, 195  
Surge arrester, 1-pole with remote signalling, 182  
Surge arrester, 1-pole, leakage current-free, 192  
Surge arrester, 2-pole, 178, 181, 186, 188

## S

Surge arrester, 2-pole + NPE, 176, 179  
 Surge arrester, 2-pole + NPE with remote signalling, 177, 180  
 Surge arrester, 2-pole with remote signalling, 182, 189  
 Surge arrester, 2-pole, with acoustic signalling, 183  
 Surge arrester, 3-pole, 178, 181, 186, 188  
 Surge arrester, 3-pole + NPE, 176, 179, 185, 202-203  
 Surge arrester, 3-pole + NPE with acoustic signalling, 180  
 Surge arrester, 3-pole + NPE with remote signalling, 177, 180, 185, 202  
 Surge arrester, 3-pole with acoustic signalling, 183  
 Surge arrester, 3-pole with fuse monitoring, 184  
 Surge arrester, 3-pole with NPE, 191  
 Surge arrester, 3-pole with NPE and remote signalling, 191  
 Surge arrester, 3-pole with remote signalling, 182, 187, 189  
 Surge arrester, 4-pole, 181, 186, 188  
 Surge arrester, 4-pole with acoustic signalling, 183  
 Surge arrester, 4-pole with fuse monitoring, 184  
 Surge arrester, 4-pole with remote signalling, 182, 189  
 Surge protection for high-speed networks up to 10, 250 GBit (Class EA/CAT6A)

## T

T connector, 382  
 T connector Rd 8 mm, 359  
 T connector Rd 8–10 mm, 359-360  
 T connector Rd 8-10 mm, triple-screwed, 360  
 Tapered pipe interception rod, 332  
 Terminal for FangFix system, 334  
 Testing unit for lightning barriers, 292  
 TrayFix mounting adapter for mesh cable trays on, 334, 377  
 FangFix system

## U

Underfloor test box, 376  
 Underfloor test box with integrated separation point, 376  
 Universal adapter for roof cable holder, type, 345 165/MBG  
 Universal bi-metal separating piece, 373  
 Universal cable bracket Rd 8–10 mm, 348  
 Universal cable bracket Rd 8–10 mm with pre-, 348 mounted wood screw  
 Universal cable bracket Rd 8–10 mm, copper-plated, 348  
 Universal clamping block Rd 8–10 mm, 368  
 Universal downspout clip 60–130 mm, 369-370  
 Universal separating piece, 372-373  
 Upper part total spark gap between N and PE 255 V, 164, 195  
 Upper part, combination arrester with function display, 142  
 Upper part, lightning current arrester, 142  
 Upper part, lightning current arrester with function, 142 display  
 Upper part, surge arrester 150 V, 193, 204  
 Upper part, surge arrester 280 V, 193, 204  
 Upper part, surge arrester 320 V, 193, 204  
 Upper part, surge arrester 335 V, 194  
 Upper part, surge arrester 385 V, 194, 204  
 Upper part, surge arrester 440 V, 194  
 Upper part, surge arrester 550 V, 194  
 Upper part, surge arrester 75 V, 193  
 Upper part, surge protection, leak current-free, 195

## V

VA cable bracket, 389  
 VA cable bracket with tightening strap, 389  
 VA roof cable holder, sloping roof, 390  
 Variable bi-metal quick connector, 355  
 Variable earthing connector Rd 6-8 / 8-10 mm, 355-356  
 Variable earthing terminal, 322  
 Vario quick connector, 355  
 Vario quick connector Rd 8-10x16, 356  
 VG housing with MC 50-B/3, 139  
 VG housing with MC 50-B/3+1, 138

## V

VG housing with MCD 50-B/3, 139  
 VG housing with MCD 50-B/3+1, 138

## W

Wall connection, 383  
 Wall connection, angled, 385  
 Washer for cable bracket, type 177, 347  
 Water repellent, 386  
 Wedge connector, 323  
 Wire straightening machine, 378

## Z

Zinc repairs, 377

# Numeric directory

Structure of the GTIN: Country code **40**    Manufacturer code **1219**    Individual GTIN **5647589**

GTIN	Art. no.	Price	Page	GTIN	Art. no.	Price	Page	GTIN	Art. no.	Price	Page	GTIN	Art. no.	Price	Page
504651	1117 02 5	/100 m	306	525039	3133 02 8	/100 pc.	378	569934	5015 83 6	/pc.	301	538551	5040 13 2	/100 pc.	304
504657	1117 03 3		306	525045	3133 03 6		378	500226	5015 84 2		301	538557	5040 15 9		304
				525057	3133 23 0		378	569935	5015 84 4		301	538593	5040 50 7		304
543237	1167 00 6	/100 pc.	306			/pc.		569936	5015 84 7		301				
543243	1167 01 4		306	537129	5000 01 7		313	569940	5015 84 9		301	538599	5043 01 8		306
543249	1167 02 2		306	537135	5000 02 5		313	500227	5015 85 4		301	538605	5043 10 7		306
543255	1167 03 0		306	537147	5000 20 3		313	500228	5015 86 6		301				
543261	1167 04 9		306	501800	5000 29 7		312	503361	5015 88 0		301	538611	5050 03 0		304
				561735	5000 30 0		312	503367	5015 88 4		301	538617	5050 05 7		304
511671	1362 01 1		352	570883	5000 33 5		312	503373	5015 89 0		301	538623	5050 07 3		304
511683	1362 04 6		354	537171	5000 50 5		313				302	538629	5050 08 1		304
				501804	5000 74 2		312	537909	5016 02 9		302	538635	5050 11 1		304
565536	2146 16 4		389	581445	5000 75 0		312	537915	5016 03 7		302	538641	5050 13 8		304
559571	2146 20 7		389	511104	5000 76 9		312	537921	5016 04 5		302	538647	5050 15 4		304
501606	2146 50 9		389	574065	5000 85 8		312	592221	5016 09 6		302	538653	5050 17 0		304
				537183	5000 86 6		312	580035	5016 11 8		302	538659	5050 19 7		304
				537189	5000 94 7		312	592227	5016 12 6		302				
				537195	5000 95 5		312	537927	5016 14 2		323	538665	5051 50 9		305
574167	2153 73 4		390												
550539	2153 78 7		390	537237	5001 21 8		318	580041	5018 50 1	/100 m	310	538683	5052 07 6		305
				537243	5001 22 6		318	580047	5018 70 6		310	538689	5052 09 2		305
				563547	5001 36 6		318	502201	5018 73 0		310	538695	5052 11 4		305
589692	2332 78 4		393	537255	5001 40 4		318				310	538701	5052 13 0		305
				537261	5001 41 2		318	568046	5019 34 0		310	538707	5052 15 7		305
522885	2349 04 3		378	537285	5001 56 0		318	569400	5019 34 2		310	538719	5052 18 1		305
522891	2349 05 1		378	563523	5001 61 7		318	569401	5019 34 4		310	538851	5057 50 7		303
522897	2349 07 8		378	575265	5001 62 5		318	568047	5019 34 5		310	538857	5057 51 5		303
522903	2349 08 6		378	586269	5001 63 3		318	568048	5019 34 7		310	538863	5057 52 3		303
522915	2349 10 8		378	537291	5001 64 1		318	568049	5019 35 0		310	538869	5057 55 8		303
522921	2349 12 4		378	537297	5001 66 8		318	568050	5019 35 5		310	569965	5057 59 9		392
501618	2351 70 6		389	590125	5001 67 2		318	568051	5019 36 0		310				
				575487	5001 74 9	/pc.	318	538155	5021 08 1		310	580545	5057 92 2	/100 m	303
523053	2360 05 5	/pc.	326				318	538161	5021 10 3		310	580551	5057 93 0	/100 pc.	303
523059	2360 10 1		326	537357	5003 00 8		316	538173	5021 16 2		310				
				537363	5003 01 6		316	580137	5021 22 7		311	538887	5059 35 6		326
				537369	5003 02 4		316	568052	5021 23 5		311	538905	5059 49 6		326
551841	2362 97 0		377	537375	5003 03 2		316	568056	5021 23 9		311				
				537381	5003 04 0		316	538191	5021 28 6		311	538923	5064 01 5		306
				537399	5003 25 3		316	590127	5021 29 4		311				
524271	3041 20 4		313	537405	5003 26 1		316	538197	5021 30 8		311				
524277	3041 21 2		313	537411	5003 28 8		316	506747	5021 33 2		311				
524283	3041 25 5		313	537417	5003 29 6		316	538203	5021 48 0		311	591597	5080 05 3	/pc.	255
561723	3041 40 9		313	537423	5003 31 8		316	538209	5021 50 2		311	591627	5080 06 1		256
524295	3041 95 6		313	537471	5003 77 6		317	590205	5021 64 2		311	591603	5080 15 0		255
				537477	5003 78 4		317	568057	5021 64 4		311	591621	5080 27 4		255
524313	3042 20 0		314					568058	5021 64 7		311	591639	5080 28 2		256
524319	3042 25 1		314	537687	5009 21 9		317	538221	5021 65 0						
561729	3042 30 8		313	537693	5009 22 7		317	583620	5021 65 4			588945	5081 54 8		239
				537699	5009 23 5		317	538233	5021 80 4		310	550263	5081 64 5		253
												550269	5081 64 7		253
524331	3043 20 7		314			/100 pc.	322	538269	5025 20 6	/100 pc.	325	583479	5081 68 8		237
524337	3043 25 8		314	537771	5012 01 5		322				325	523995	5081 72 6		252
571749	3043 31 2		314									523989	5081 73 4		252
524355	3043 40 1		314			/pc.	323	538305	5028 03 5		325	523983	5081 74 2		252
524361	3043 45 2		314	537789	5014 01 8		323	538311	5028 04 3		325	546243	5081 79 3		250
511116	3043 60 2		315	537795	5014 02 6		323					561436	5081 80 0		250
561741	3043 60 6		315	537801	5014 21 2		323	538341	5030 02 1		325	568053	5081 92 0		237
508707	3043 61 0		315	590193	5014 42 5		322	538365	5030 23 4			568041	5081 93 9		238
508713	3043 61 4		315	510501	5014 46 8		322	538371	5030 24 2			579111	5081 96 3		238
511164	3043 61 8		315	510507	5014 47 6		322					579105	5081 97 1		238
542162	3043 62 8		315					538383	5032 03 2		324				
524379	3043 70 3		314	537807	5015 01 4		299	538389	5032 04 0		324	568533	5082 38 2		251
524385	3043 75 4		314	537813	5015 05 7		298	538395	5032 23 7		324	568491	5082 41 2		250
564231	3043 90 8		314	537819	5015 06 5			538401	5032 24 5		324	568485	5082 42 0		250
545379	3043 91 6		315	537825	5015 07 3		297	538413	5032 53 9		324	568507	5082 42 2		251
				537831	5015 08 1		298	538419	5032 54 7		324				
564297	3044 83 1		315	595942	5015 11 1		300					591759	5083 06 0		257
564303	3044 90 4		315	580011	5015 20 0		298	538443	5033 03 9		324	591771	5083 08 7		257
545397	3044 91 2		315	537837	5015 50 2		298	543375	5033 20 9		324	502297	5083 40 0		248
				537843	5015 54 5										
				537849	5015 55 3		299	538455	5038 01 4		304	552513	5084 00 8		241
		/100 pc.		547783	5015 55 7			538461	5038 03 0		304	552519	5084 01 2		241
563169	3049 20 5		326	537855	5015 65 0		296	538467	5038 05 7		304	552525	5084 01 6		241
563163	3049 22 1		326	537861	5015 70 7		297	538473	5038 07 3		304	552531	5084 02 0		241
563157	3049 25 6		326	537867	5015 71 5		297	538479	5038 08 1		304	552537	5084 02 4		242
563151	3049 30 2		326	537873	5015 72 3		297	538485	5038 11 1		304	552543	5084 02 8		242
563145	3049 32 9		326	537879	5015 73 1		296	538491	5038 13 8		304	552549	5084 03 2		242

GTIN	Art. no.	Price	Page	GTIN	Art. no.	Price	Page	GTIN	Art. no.	Price	Page	GTIN	Art. no.	Price	Page
		/pc.				/pc.				/pc.				/pc.	
589080	<b>5088 60 5</b>		230	547855	<b>5093 62 8</b>		220	536393	<b>5094 92 4</b>		203	557813	<b>5097 61 5</b>		214
589081	<b>5088 60 9</b>		230	570906	<b>5093 62 9</b>		220	536394	<b>5094 93 1</b>		202	557814	<b>5097 62 3</b>		214
587264	<b>5088 62 5</b>		224	536190	<b>5093 63 1</b>		150					557815	<b>5097 63 1</b>		215
587265	<b>5088 62 9</b>		224	536191	<b>5093 64 3</b>		150	591939	<b>5095 60 3</b>		164	557816	<b>5097 65 0</b>		215
582946	<b>5088 64 6</b>		224	536192	<b>5093 64 7</b>		150	554295	<b>5095 60 6</b>		156	557818	<b>5097 82 0</b>		216
582947	<b>5088 64 8</b>		224	568842	<b>5093 65 3</b>		148					581225	<b>5097 82 2</b>		261
578070	<b>5088 65 0</b>		226	542512	<b>5093 65 4</b>		148	539319	<b>5096 25 1</b>		184	581226	<b>5097 82 4</b>		262
578071	<b>5088 65 1</b>		225	583679	<b>5093 65 5</b>		148	539325	<b>5096 27 8</b>		184	557819	<b>5097 84 6</b>		216
578072	<b>5088 65 2</b>		225	568843	<b>5093 66 1</b>		149	539355	<b>5096 35 9</b>		165	557821	<b>5097 85 8</b>		216
570895	<b>5088 67 0</b>		229	542513	<b>5093 66 2</b>		149	539361	<b>5096 36 7</b>		165	557824	<b>5097 93 1</b>		217
570896	<b>5088 67 2</b>		229	536195	<b>5093 72 4</b>		151	506340	<b>5096 37 0</b>		166	557825	<b>5097 93 5</b>		217
570900	<b>5088 67 6</b>		229	570884	<b>5093 72 6</b>		231	524710	<b>5096 37 2</b>		166	557826	<b>5097 93 9</b>		217
570901	<b>5088 67 8</b>		229	596224	<b>5093 98 8</b>		246	539367	<b>5096 37 5</b>		183	557827	<b>5097 97 6</b>		265
561370	<b>5088 69 1</b>		226	580599	<b>5093 99 6</b>		246	539373	<b>5096 38 3</b>		183				
561371	<b>5088 69 2</b>		226					539379	<b>5096 39 1</b>		183	568333	<b>5098 38 0</b>		282
561372	<b>5088 69 3</b>		226	568193	<b>5094 40 0</b>		151	561747	<b>5096 39 7</b>		180	568334	<b>5098 38 2</b>		282
537109	<b>5088 69 4</b>		230	545747	<b>5094 40 1</b>		155	539385	<b>5096 41 3</b>		166	568338	<b>5098 39 0</b>		282
583564	<b>5088 69 5</b>		227	538281	<b>5094 40 3</b>		155	539391	<b>5096 42 1</b>		166	568339	<b>5098 39 2</b>		282
583565	<b>5088 69 6</b>		227	540655	<b>5094 41 8</b>		158	539397	<b>5096 44 8</b>		166	540683	<b>5098 40 4</b>		274
547320	<b>5088 69 9</b>		230	538282	<b>5094 42 1</b>		158	546445	<b>5096 63 7</b>		232	540684	<b>5098 40 7</b>		274
570401	<b>5088 70 3</b>		228	523973	<b>5094 42 3</b>		158	546446	<b>5096 63 9</b>		232	540685	<b>5098 41 1</b>		274
504715	<b>5088 87 9</b>		164	523974	<b>5094 42 6</b>		158	564849	<b>5096 64 6</b>		232	584851	<b>5098 41 2</b>		284
				540656	<b>5094 43 1</b>		162	529945	<b>5096 64 7</b>		232	562512	<b>5098 41 3</b>		277
553101	<b>5089 20 0</b>		138	538283	<b>5094 43 4</b>		162	541573	<b>5096 64 8</b>		165	578737	<b>5098 41 5</b>		278
553107	<b>5089 21 2</b>		139	523975	<b>5094 43 7</b>		162	541574	<b>5096 64 9</b>		165	577361	<b>5098 41 9</b>		278
523734	<b>5089 65 0</b>		201	523976	<b>5094 44 0</b>		162	541577	<b>5096 65 0</b>		165	540686	<b>5098 42 2</b>		275
529940	<b>5089 65 2</b>		201	537488	<b>5094 44 4</b>		157	541578	<b>5096 65 1</b>		165	578738	<b>5098 42 5</b>		279
523735	<b>5089 65 5</b>		164	538284	<b>5094 44 8</b>		154	541579	<b>5096 65 3</b>		165	540687	<b>5098 42 7</b>		275
570935	<b>5089 66 0</b>		206	523981	<b>5094 45 4</b>		154	541580	<b>5096 65 4</b>		165	540688	<b>5098 43 1</b>		275
570936	<b>5089 66 2</b>		206	538285	<b>5094 45 7</b>		156	506748	<b>5096 65 5</b>		165	584852	<b>5098 43 2</b>		284
575978	<b>5089 74 8</b>		167	523982	<b>5094 46 0</b>		156	506749	<b>5096 65 7</b>		165	562513	<b>5098 43 3</b>		279
540552	<b>5089 75 4</b>		168	523986	<b>5094 46 3</b>		156	506750	<b>5096 66 5</b>		165	540689	<b>5098 44 2</b>		276
580681	<b>5089 75 5</b>		168	523988	<b>5094 47 8</b>		161	506753	<b>5096 66 7</b>		165	540690	<b>5098 44 6</b>		276
540553	<b>5089 75 6</b>		168	523992	<b>5094 49 0</b>		159	506754	<b>5096 66 9</b>		165	540691	<b>5098 45 0</b>		276
581661	<b>5089 75 7</b>		168	523993	<b>5094 49 3</b>		159	506755	<b>5096 67 1</b>		165	584853	<b>5098 45 2</b>		284
540554	<b>5089 76 1</b>		167	523994	<b>5094 51 0</b>		157	587120	<b>5096 67 2</b>		191	541046	<b>5098 47 0</b>		280
540555	<b>5089 76 3</b>		167	523999	<b>5094 52 6</b>		161	587124	<b>5096 67 3</b>		191	581352	<b>5098 47 5</b>		280
540556	<b>5089 76 8</b>		170	524001	<b>5094 55 2</b>		160	542514	<b>5096 67 5</b>		152	557828	<b>5098 49 2</b>		266
540557	<b>5089 77 0</b>		169	570907	<b>5094 57 2</b>		222	542515	<b>5096 67 7</b>		152	557829	<b>5098 50 6</b>		266
540558	<b>5089 77 5</b>		170	564848	<b>5094 57 4</b>		223	506756	<b>5096 68 0</b>		165	557830	<b>5098 51 4</b>		266
540559	<b>5089 77 7</b>		169	570908	<b>5094 57 6</b>		222	506759	<b>5096 68 2</b>		165	557831	<b>5098 52 2</b>		266
		/VPE		570887	<b>5094 60 5</b>		222	581348	<b>5096 69 3</b>		164	557833	<b>5098 55 7</b>		267
				547862	<b>5094 60 8</b>		223	561637	<b>5096 69 5</b>		164	557834	<b>5098 57 1</b>		265
546111	<b>5091 32 2</b>		293	570888	<b>5094 61 3</b>		222	551913	<b>5096 70 7</b>		193	557835	<b>5098 57 5</b>		265
546129	<b>5091 43 8</b>		293	570911	<b>5094 61 5</b>		223	542518	<b>5096 78 6</b>		292	557836	<b>5098 60 0</b>		269
546147	<b>5091 52 7</b>		293	547866	<b>5094 61 7</b>		223	592173	<b>5096 81 2</b>		292	557837	<b>5098 60 3</b>		269
		/pc.		540659	<b>5094 61 8</b>		181	548073	<b>5096 82 0</b>		142	557838	<b>5098 61 1</b>		269
546165	<b>5091 68 3</b>		293	538286	<b>5094 62 1</b>		181	554451	<b>5096 82 2</b>		142	557839	<b>5098 63 0</b>		269
589611	<b>5091 69 1</b>		293	524002	<b>5094 62 4</b>		181	505142	<b>5096 82 5</b>		142	557840	<b>5098 63 8</b>		270
				524003	<b>5094 62 7</b>		181	505147	<b>5096 82 7</b>		142	557841	<b>5098 64 6</b>		270
508088	<b>5092 45 1</b>		212	537492	<b>5094 63 2</b>		182	528828	<b>5096 83 5</b>		137	557842	<b>5098 72 7</b>		268
524709	<b>5092 46 0</b>		212	537498	<b>5094 63 6</b>		189	528829	<b>5096 83 6</b>		136	557843	<b>5098 79 4</b>		268
547580	<b>5092 46 6</b>		212	538296	<b>5094 63 9</b>		176	548079	<b>5096 83 9</b>		143	557844	<b>5098 80 8</b>		271
561358	<b>5092 47 0</b>		212	524004	<b>5094 64 1</b>		176	596638	<b>5096 84 7</b>		141	557845	<b>5098 81 6</b>		271
561359	<b>5092 47 2</b>		212	524005	<b>5094 64 4</b>		176	554115	<b>5096 84 9</b>		137	557846	<b>5098 82 4</b>		271
531483	<b>5092 60 4</b>		211	538297	<b>5094 65 0</b>		179	505141	<b>5096 85 1</b>		141	557851	<b>5098 85 9</b>		272
595281	<b>5092 70 1</b>		211	524006	<b>5094 65 3</b>		179	505146	<b>5096 85 2</b>		137	557852	<b>5098 86 7</b>		271
503505	<b>5092 80 0</b>		210	524009	<b>5094 65 6</b>		179	596644	<b>5096 86 3</b>		140				
503511	<b>5092 80 8</b>		210	538298	<b>5094 66 6</b>		185	554139	<b>5096 86 5</b>		136	540671	<b>5099 47 5</b>		192
504722	<b>5092 81 2</b>		211	524011	<b>5094 66 8</b>		185	536202	<b>5096 87 4</b>		139	539673	<b>5099 57 9</b>		193
503517	<b>5092 81 6</b>		210	540661	<b>5094 67 7</b>		178	536203	<b>5096 87 5</b>		138	539685	<b>5099 59 5</b>		194
503523	<b>5092 82 4</b>		210	538288	<b>5094 67 9</b>		178	507704	<b>5096 87 6</b>		141	539691	<b>5099 60 9</b>		193
504725	<b>5092 82 8</b>		211	524012	<b>5094 68 0</b>		178	507707	<b>5096 87 7</b>		137	570890	<b>5099 61 1</b>		231
				540665	<b>5094 70 3</b>		186	507708	<b>5096 87 8</b>		140	580761	<b>5099 61 3</b>		195
539067	<b>5093 01 5</b>		245	538289	<b>5094 70 4</b>		186	507709	<b>5096 87 9</b>		136	539697	<b>5099 61 7</b>		194
539073	<b>5093 02 3</b>		245	524015	<b>5094 70 5</b>		186	553113	<b>5096 88 4</b>		143	594249	<b>5099 70 6</b>		194

# Numeric directory

Structure of the GTIN: Country code **40** Manufacturer code **1219** Individual GTIN **5647589**

GTIN	Art. no.	Price	Page	GTIN	Art. no.	Price	Page	GTIN	Art. no.	Price	Page	GTIN	Art. no.	Price	Page
540039	<b>5102 27 8</b>	/100 pc.	371	540879	<b>5218 68 3</b>	/100 pc.	345	541647	<b>5304 60 1</b>	/100 pc.	358	543368	<b>5316 45 0</b>	/100 pc.	365
				540885	<b>5218 69 1</b>		345	581775	<b>5304 66 0</b>		358	543372	<b>5316 45 9</b>		365
		/pc.		590451	<b>5218 74 8</b>		345	541695	<b>5304 97 0</b>		358	543373	<b>5316 46 8</b>		365
540087	<b>5106 00 1</b>		376	581463	<b>5218 75 6</b>		345	541707	<b>5304 99 7</b>		322	542031	<b>5316 51 0</b>		367
540093	<b>5106 02 8</b>		376	540891	<b>5218 81 0</b>		346					542037	<b>5316 55 3</b>		367
590037	<b>5106 13 3</b>		376	540897	<b>5218 82 9</b>		346								
590043	<b>5106 14 1</b>		376	540903	<b>5218 86 1</b>		345	541731	<b>5311 03 9</b>		359	542043	<b>5317 01 0</b>		363
		/100 pc.				/pc.		541737	<b>5311 10 1</b>		359	542049	<b>5317 05 3</b>		363
540159	<b>5201 10 1</b>		336	567458	<b>5218 88 2</b>	/100 pc.	345	541743	<b>5311 15 2</b>		360	542055	<b>5317 20 7</b>		363
								541749	<b>5311 20 9</b>		360	589315	<b>5317 20 8</b>		363
				562305	<b>5218 88 5</b>		345	541755	<b>5311 26 8</b>		360			/100 pc.	
590433	<b>5202 21 3</b>		344	540909	<b>5218 92 6</b>		369	581658	<b>5311 41 0</b>		355	542061	<b>5317 22 3</b>		364
540213	<b>5202 24 8</b>		344	595221	<b>5218 97 7</b>		346	581659	<b>5311 41 7</b>		356	542067	<b>5317 25 8</b>		364
540303	<b>5202 51 5</b>		340	562588	<b>5218 99 7</b>		346	541767	<b>5311 50 0</b>		355	542073	<b>5317 27 4</b>		364
590229	<b>5202 56 6</b>		341					573706	<b>5311 50 3</b>		305	542079	<b>5317 40 1</b>		364
589412	<b>5202 56 8</b>		341	540945	<b>5223 07 5</b>		350	541773	<b>5311 51 9</b>		355	542085	<b>5317 42 8</b>		365
589422	<b>5202 56 9</b>		344	540951	<b>5223 10 5</b>		350	541779	<b>5311 52 7</b>		355	542091	<b>5317 45 2</b>		364
590223	<b>5202 59 0</b>		341	540963	<b>5223 15 6</b>		350	583539	<b>5311 53 0</b>		301	542097	<b>5317 47 9</b>		365
540381	<b>5202 83 3</b>		340	540975	<b>5223 20 2</b>		350	541785	<b>5311 53 5</b>		355	585086	<b>5317 48 1</b>		364
578492	<b>5202 83 6</b>		340	540993	<b>5223 60 1</b>		350	541791	<b>5311 55 1</b>		355				
590217	<b>5202 86 8</b>		340					583534	<b>5311 55 4</b>		301	542103	<b>5318 08 4</b>		363
				541041	<b>5226 57 0</b>		350	569378	<b>5311 57 3</b>		306	542109	<b>5318 14 9</b>		363
503826	<b>5203 01 5</b>		340					546619	<b>5311 58 5</b>		305				
578496	<b>5203 01 8</b>		340	541053	<b>5227 07 0</b>		351	592544	<b>5311 59 0</b>		356	542127	<b>5320 01 1</b>		368
528974	<b>5203 02 3</b>		340	541059	<b>5227 08 9</b>		351			/100 pc.		542133	<b>5320 05 4</b>		368
				541065	<b>5227 10 0</b>		351	545199	<b>5311 70 5</b>		355	542151	<b>5320 69 0</b>		369
540465	<b>5207 25 8</b>		348	541071	<b>5227 15 1</b>		351	545205	<b>5311 71 3</b>		355	542157	<b>5320 70 4</b>		369
511039	<b>5207 26 6</b>		348									542163	<b>5320 71 2</b>		369
540477	<b>5207 33 9</b>		347	541083	<b>5228 02 6</b>		351	541797	<b>5312 03 5</b>		361				
573576	<b>5207 34 2</b>		347	541095	<b>5228 12 3</b>		351	541803	<b>5312 13 2</b>		361	542187	<b>5325 30 7</b>		367
540483	<b>5207 34 7</b>		347	541101	<b>5228 13 1</b>		351	541809	<b>5312 31 0</b>		320	542193	<b>5325 31 5</b>		367
506954	<b>5207 37 1</b>		347	585101	<b>5228 13 4</b>		351	570086	<b>5312 31 8</b>		320				
540489	<b>5207 44 4</b>		348	541107	<b>5228 22 0</b>		353	541815	<b>5312 34 5</b>		320	542241	<b>5326 30 3</b>		368
500972	<b>5207 45 1</b>		348	541119	<b>5228 32 8</b>		351					542247	<b>5326 31 1</b>		368
540495	<b>5207 46 0</b>		348					589310	<b>5312 34 6</b>		320	542253	<b>5326 33 8</b>		368
540501	<b>5207 48 7</b>		348	541149	<b>5229 16 2</b>		349								
590499	<b>5207 74 6</b>		348	541155	<b>5229 36 7</b>		350			/100 pc.		545361	<b>5328 20 9</b>		359
590505	<b>5207 75 4</b>		348	541161	<b>5229 38 3</b>		350	541821	<b>5312 41 8</b>		320	545367	<b>5328 28 4</b>		359
590511	<b>5207 76 2</b>		348	541167	<b>5229 46 4</b>		350	541827	<b>5312 44 2</b>		320				
590487	<b>5207 80 0</b>		347	541173	<b>5229 48 0</b>		350	541833	<b>5312 60 4</b>		319	542319	<b>5329 07 8</b>		359
590493	<b>5207 81 9</b>		347	541197	<b>5229 55 3</b>		350	541839	<b>5312 65 5</b>		321				
533643	<b>5207 85 1</b>		348	541215	<b>5229 83 9</b>		349					588557	<b>5331 00 8</b>		369
533481	<b>5207 87 8</b>		348	541221	<b>5229 96 0</b>		349	589314	<b>5312 65 6</b>		321	542337	<b>5331 01 3</b>		369
591583	<b>5207 90 1</b>		347	584088	<b>5229 96 1</b>		349			/100 pc.		588558	<b>5331 01 7</b>		369
		/100 pc.		544623	<b>5230 21 7</b>		349	541857	<b>5312 80 9</b>		320	542343	<b>5331 50 1</b>		369
540525	<b>5208 01 7</b>		351	562953	<b>5230 32 2</b>		349	541869	<b>5312 90 6</b>		321	562911	<b>5334 93 4</b>		323
				562947	<b>5230 36 5</b>		349	541875	<b>5312 92 2</b>		321	595966	<b>5334 94 2</b>		323
590367	<b>5215 27 7</b>		343	573999	<b>5230 44 6</b>		324	570087	<b>5312 92 5</b>		321				
590379	<b>5215 30 7</b>		344	574005	<b>5230 46 2</b>		324					589005	<b>5335 14 0</b>		372
581187	<b>5215 37 4</b>		343	595960	<b>5230 52 7</b>		353	574053	<b>5313 01 5</b>		321	589011	<b>5335 16 7</b>		372
581193	<b>5215 38 2</b>		343					574047	<b>5313 02 3</b>		321	542361	<b>5335 20 5</b>		372
540717	<b>5215 43 9</b>		343					554301	<b>5313 03 1</b>		321	542367	<b>5335 25 6</b>		372
581211	<b>5215 47 1</b>		343			/pc.		580653	<b>5313 06 6</b>		321				
540723	<b>5215 50 1</b>		342	541257	<b>5240 03 4</b>		288					542421	<b>5336 00 7</b>		372
578497	<b>5215 50 4</b>		342	541263	<b>5240 05 0</b>		289	541899	<b>5314 03 8</b>		361	542427	<b>5336 02 3</b>		373
590259	<b>5215 54 4</b>		341	541269	<b>5240 06 9</b>		288	541911	<b>5314 13 5</b>		361	542433	<b>5336 05 8</b>		372
540729	<b>5215 55 2</b>		341	541275	<b>5240 07 7</b>		288					542439	<b>5336 07 4</b>		373
578498	<b>5215 55 5</b>		341	541281	<b>5240 08 5</b>		288	541917	<b>5314 51 8</b>		319	542445	<b>5336 09 0</b>		373
581223	<b>5215 57 9</b>		341					541923	<b>5314 53 4</b>		319	542463	<b>5336 30 9</b>		373
578501	<b>5215 58 2</b>		341	541299	<b>5240 22 0</b>		288	541929	<b>5314 61 5</b>		319	542475	<b>5336 34 1</b>		373
581229	<b>5215 58 7</b>		341	541305	<b>5240 23 9</b>		288	589309	<b>5314 61 6</b>		319	542481	<b>5336 37 6</b>		373
581235	<b>5215 59 5</b>		341	541311	<b>5240 24 7</b>		288			/100 pc.		542487	<b>5336 45 7</b>		373
578502	<b>5215 59 8</b>		341	541317	<b>5240 25 5</b>		288	541935	<b>5314 62 3</b>		319	542493	<b>5336 50 3</b>		374
581241	<b>5215 60 9</b>		341	541323	<b>5240 30 1</b>		288	541947	<b>5314 65 8</b>		319				
540735	<b>5215 62 5</b>		342	541329	<b>5240 32 8</b>		288	589308	<b>5314 65 9</b>		319	542499	<b>5340 01 2</b>		374
581253	<b>5215 66 8</b>		342	541335	<b>5240 33 6</b>		288			/100 pc.					
581259	<b>5215 74 9</b>		342	541341	<b>5240 34 4</b>		288	541953	<b>5314 66 6</b>		319	542559	<b>5350 08 5</b>		370
590235	<b>5215 80 3</b>		343					592587	<b>5314 72 0</b>		319	542565	<b>5350 09 3</b>		370
590241	<b>5215 83 8</b>		343									542571	<b>5350 10 7</b>		370
590247	<b>5215 85 4</b>		343			/100 pc.						542577	<b>5350 11 5</b>		370
553179	<b>5215 87 5</b>		342	541569	<b>5304 00 8</b>		356	541971	<b>5315 50 6</b>		358	542583	<b>5350 12 3</b>		370
553185	<b>5215 87 9</b>														

GTIN	Art. no.	Price	Page	GTIN	Art. no.	Price	Page	GTIN	Art. no.	Price	Page
589071	5351 37 5	/100 pc.	370	581378	5408 06 0	/100 pc.		575229	5412 81 1	/100 pc.	353
542721	5351 45 6		371			/pc.					
542727	5351 47 2		371	587269	5408 06 4		389	542967	5416 56 6		374
				587270	5408 06 6		389				
542757	5400 15 5		315	587274	5408 06 8		389			/pc.	
562905	5400 62 7		315	587275	5408 07 2		390	590049	5420 00 8		322
				587276	5408 07 4		390	562929	5420 01 6		322
590133	5401 77 1		334			/100 pc.				/100 pc.	
542781	5401 80 1		334	567492	5408 10 1		384	575157	5420 50 4		315
542787	5401 83 6		334			/pc.		533157	5420 53 9		315
589839	5401 85 2		334	569073	5408 10 5		382				
590211	5401 87 9		334	561320	5408 10 7		382	543009	5424 10 0		335
503481	5401 97 0		332	561321	5408 10 8		382	543021	5424 15 1		316
510561	5401 98 0		332	561322	5408 10 9		382	543033	5424 20 8		316
510777	5401 98 3		332	563673	5408 14 8		382				
510867	5401 98 6		332	568149	5408 15 6		382			/pc.	
510873	5401 98 9		332	561323	5408 15 8		382	590145	5430 01 1		316
504535	5401 99 3		332	589581	5408 24 5		383	590157	5430 06 2		316
505080	5401 99 5		332	561324	5408 24 7		383			/100 pc.	
				589587	5408 29 6		383	543057	5430 15 1		316
542805	5402 10 7		335	561325	5408 29 8		383				
542817	5402 15 8		335	567447	5408 35 0		383				
542841	5402 80 8		334	561326	5408 35 2		383			/pc.	
542847	5402 85 9		334	567441	5408 39 3		383	611761	6117 46 5		213
		/pc.		561327	5408 39 5		383	500622	6117 46 7		213
567473	5402 86 4		337	567435	5408 45 8		386	611767	6117 47 3		213
567474	5402 86 6		337	567429	5408 50 4		384	500621	6117 47 5		213
567475	5402 86 8		337	561328	5408 50 6		384				
567476	5402 87 0		337	567423	5408 55 5		384				
567479	5402 87 2		337	561329	5408 55 7		384			/100 pc.	
567480	5402 87 4		337	567417	5408 62 8		384	604908	6404 00 6		306
567481	5402 87 6		337	561331	5408 63 0		384	604920	6404 01 4		306
567482	5402 87 8		337	567381	5408 68 7		383				
567485	5402 88 0		337	561330	5408 68 9		383				
		/100 pc.		567375	5408 73 3		386				
542853	5402 89 1		335	554277	5408 80 6		387				
589791	5402 95 6		335	554283	5408 81 4		387				
				577049	5408 82 0		387				
573842	5403 10 0		334	500460	5408 84 9		386				
507005	5403 10 3		333	500973	5408 85 2		386				
507006	5403 11 0		333	585955	5408 93 0		337				
507007	5403 11 7		334	585956	5408 93 2		337				
507008	5403 12 4		334	587161	5408 93 4		338				
554871	5403 20 0		333	587162	5408 93 6		338				
511063	5403 20 5		333	587166	5408 93 8		337				
554877	5403 21 9		334	587167	5408 94 0		337				
554889	5403 22 7		333	567005	5408 94 2		337				
554895	5403 23 5		333	578533	5408 94 3		337				
592632	5403 23 8		338	567006	5408 94 6		337				
		/pc.		578534	5408 94 7		337				
503487	5403 30 8		332	567007	5408 95 0		338				
503493	5403 32 4		332	567008	5408 95 2		338				
561357	5403 33 0		336	567009	5408 95 4		338				
581390	5403 33 3		336	584936	5408 95 5		339				
567073	5403 33 5		335	567010	5408 95 6		339				
		/100 pc.		584939	5408 95 7		339				
542865	5405 06 8		332	567011	5408 95 8		339				
		/pc.		584940	5408 95 9		339				
542871	5405 76 9		336	567012	5408 96 0		339				
		/100 m		567013	5408 96 4		339				
588812	5407 99 5		388	580243	5408 96 6		337				
588815	5407 99 7		388	580244	5408 96 7		337				
				567014	5408 96 8		337				
567457	5408 00 2		388	567493	5408 96 9		337				
567462	5408 00 4		388	567494	5408 97 1		338				
585426	5408 00 6		388	567497	5408 97 2		338				
		/pc.		567498	5408 97 3		338				
567463	5408 00 9		388	561332	5408 97 6		382				
567464	5408 01 1		388	561333	5408 97 8		382				
567468	5408 02 2		388	561334	5408 98 0		382				
586417	5408 02 4		391	561335	5408 98 2		382				
567469	5408 02 6		392	561336	5408 98 4		385				
567470	5408 02 8		392	561337	5408 98 6		385				
				561338	5408 98 8		385				
587156	5408 03 1		391	561341	5408 99 0		385				
567471	5408 03 6		388	561342	5408 99 2		385				
				561343	5408 99 4		385				
567486	5408 04 3		390	561344	5408 99 6		386				
567487	5408 04 7		390			/100 pc.					
567488	5408 04 9		390	542889	5410 09 6		353				
567472	5408 05 2		389	542907	5410 30 4		353				
567491	5408 05 4		389								
569966	5408 05 6		389	542961	5412 60 9		352				
581377	5408 05 8		389	544641	5412 63 3		352				
				575235	5412 80 3		353				

02\_TBS\_Masterkatalog\_Länder\_2012 / en / 10/04/2012 / LLExpport\_01433

# Type listing

Structure of the GTIN: Country code **40**      Manufacturer code **1219**      Individual GTIN **5647589**

Type	Dimensions/Colour/Div.	GTIN	Art. no.	Price	Page	Type	Dimensions/Colour/Div.	GTIN	Art. no.	Price	Page
101 16-1500	1500/ GFK	5613213	5408 10 8	/pc.	382	101 VL2500	2500/ AI	5108672	5401 98 6	/100 pc.	332
101 16-3000	3000/ GFK	5613220	5408 10 9		382	101 VL3000	3000/ AI	5108733	5401 98 9		332
101 16-750	750/ GFK	5613206	5408 10 7		382	101 VL3500	3500/ AI	5045359	5401 99 3		332
101 20-3000	3000/ GFK	5690733	5408 10 5		382	101 VL4000	4000/ AI	5050803	5401 99 5		332
101 20-6000	6000/ GFK	5636731	5408 14 8		382					/pc.	
101 3B-4000	2000/ AI	5674733	5402 86 4		337	101 VRS-16	750	5613350	5408 98 2		382
101 3B-4500	2500/ AI	5674740	5402 86 6		337	101 VS-16	750	5613336	5408 97 8		382
101 3B-5000	3000/ AI	5674757	5402 86 8		337	101 W-16	1660/ AI	5613305	5408 68 9		383
101 3B-5500	3500/ AI	5674764	5402 87 0		337	101 WG-16	16110	5613374	5408 98 6		385
101 3B-6000	4000/ AI	5674795	5402 87 2		337					/100 pc.	
101 3B-6500	4500/ AI	5674801	5402 87 4		337	108 B DIN	/ St / FT	5429678	5416 56 6		374
101 3B-7000	5000/ AI	5674818	5402 87 6		337						
101 3B-7500	5500/ AI	5674825	5402 87 8		337						
101 3B-8000	5500/ AI	5674856	5402 88 0		337	112 DIN-100	100/ St / F	5428893	5410 09 6		353
101 3-ES-16	750	5613329	5408 97 6		382	112 DIN-CU-100	100/ Cu	5429074	5410 30 4		353
101 A-1500	1500/ St / FT	5427575	5400 15 5	/100 pc.	315	113 8-10	/ Zn / Cu	5446231	5230 21 7		349
101 A-1500	1500/ St / FT	5427575	5400 15 5		332	113 B-HD-16	/ Zn / Cu	5752295	5412 81 1		353
101 A-1500	1500/ St / FT	5427575	5400 15 5		375	113 B-MS-HD 8-10	/ Zn / Cu	5629474	5230 36 5		349
				/pc.		113 BZ-FL	/ Zn / G	5739999	5230 44 6		324
101 A-16	1660/ AI	5613268	5408 35 2		383	113 B-ZHD	/ Zn / VZ	5629535	5230 32 2		349
				/100 pc.		113 B-ZHD	/ Zn / VZ	5752356	5412 80 3		353
101 A-CU	1500/ Cu	5629054	5400 62 7		315	113 B-ZHD-FL	/ Zn / G	5740056	5230 46 2		324
101 A-CU	1500/ Cu	5629054	5400 62 7		333	113 Z-16	/ Zn / VZ	5429616	5412 60 9		352
101 A-CU	1500/ Cu	5629054	5400 62 7		375	113 Z-20	/ Zn / VZ	5959601	5230 52 7		353
101 A-L100	1000/ St / FT	5428411	5402 80 8		334	113 Z-20	/ Zn / VZ	5959601	5230 52 7		386
101 A-L150	1500/ St / FT	5428473	5402 85 9		334	113 Z-10	/ Zn / G	5412212	5229 96 0		349
101 ALU-1000	1000/ AI	5901334	5401 77 1		334	113 Z-K 8-10	/ Zn / G	5840886	5229 96 1		349
101 ALU-1500	1500/ AI	5427810	5401 80 1		334	113 ZN-16	/ Zn / Cu	5446415	5412 63 3		352
101 ALU-2000	2000/ AI	5427872	5401 83 6		334						
101 ALU-2500	2500/ AI	5898399	5401 85 2		334	120 A	/ Zn / G	5428657	5405 06 8		332
101 ALU-3000	3000/ AI	5902119	5401 87 9		334						
101 A-M16	2060/ AI	5674474	5408 35 0	/pc.	383	128 F	/ St / FT	5428718	5405 76 9	/pc.	336
101 B-16 M16	M16	5897910	5402 95 6	/100 pc.	335					/100 pc.	
101 B-16 M16	M16	5897910	5402 95 6		383	132 CU	/ Cu	5902171	5202 86 8		340
				/pc.		132 GB-M8	/ St / FT	5894124	5202 56 8		341
101 BB-16	1640	5613381	5408 98 8		385	132 K-CU	/ Cu	5902232	5202 59 0		341
101 BP-16	17540	5613367	5408 98 4		385	132 K-VA	/ V2A	5403036	5202 51 5		340
				/100 pc.		132 N-DK	/ St / FT	5902294	5202 56 6		341
101 F1000	1000/ St / FT	5430094	5424 10 0		335	132 U	/ V2A	5038269	5203 01 5		340
101 F1500	1500/ St / FT	5430216	5424 15 1		316	132 U 35	/ V2A	5784968	5203 01 8		340
101 F1500	1500/ St / FT	5430216	5424 15 1		375	132 U-CU	/ V2A / Cu	5289746	5203 02 3		340
101 F1500	1500/ St / FT	5430216	5424 15 1		335	132 VA	/ V2A	5403814	5202 83 3		340
				/pc.		132 VA 35	/ V2A	5784920	5202 83 6		340
101 F-16	16121	5613428	5408 99 2		385						
				/100 pc.		133 A	/ PA	5402138	5202 24 8		344
101 F2000	2000/ St / FT	5430339	5424 20 8		316	133 NB	/ PA	5904335	5202 21 3		344
101 F2000	2000/ St / FT	5430339	5424 20 8		375						
101 F2000	2000/ St / FT	5430339	5424 20 8		335	156 16	/ St / FT	5411079	5228 22 0		353
				/pc.		156 8-10	/ St / FT	5410836	5228 02 6		351
101 FS-16	750	5613343	5408 98 0		382	156 FL	/ St / FT	5411192	5228 32 8		351
				/100 pc.		156 K8-10 CU	/ Cu	5411017	5228 13 1		351
101 G1000	1000/ St / FT	5428053	5402 10 7		335	156 K8-10 ST	/ St / FT	5410959	5228 12 3		351
101 G1500	1500/ St / FT	5428176	5402 15 8		335	156 K8-10 VA	/ V2A	5851011	5228 13 4		351
				/pc.							
101 HV-16	1690	5613411	5408 99 0		385	157 E-CU	265/ Cu	5902355	5215 80 3		343
101 IAB	18/ AI	5673750	5408 73 3		386	157 EK-CU	265/ Cu	5902478	5215 85 4		343
101 IAG	20107/ AI	5674290	5408 50 4		384	157 EK-VA	265/ V2A	5902416	5215 83 8		343
101 IAG-16	16107/ AI	5613282	5408 50 6		384	157 E-VA	265/ V2A	5407232	5215 50 1		342
101 IDK	20125/ AI	5895817	5408 24 5		383	157 E-VA 35	265/ V2A	5784975	5215 50 4		342
101 IDK-16	16125/ AI	5613244	5408 24 7		383	157 F-CU 230	/ Cu	5902539	5216 19 2		341
101 IES	2060/ AI	5674412	5408 39 3		383	157 F-CU 280	/ Cu	5813019	5216 20 6		341
101 IES-16	1660/ AI	5613275	5408 39 5		383	157 F-CU 410	/ Cu	5813132	5216 25 7		341
101 IGL	20127/ AI	5674177	5408 62 8		384	157 FK-CU 230	/ Cu	5902652	5216 18 4		342
101 IGL-16	16127/ AI	5613312	5408 63 0		384	157 FK-CU 280	/ Cu	5813071	5216 21 4		342
101 IK	20100/ AI	5895879	5408 29 6		383	157 FK-CU 410	/ Cu	5813194	5216 26 5		342
101 IK-16	16100/ AI	5613251	5408 29 8		383	157 FK-VA 230	/ V2A	5902591	5215 54 7		341
101 ISPM10	110/ AI	5674351	5408 45 8		386	157 FK-VA 280	/ V2A	5812296	5215 58 7		341
101 IT	2065/ AI	5681496	5408 15 6		382	157 FK-VA 410	/ V2A	5812418	5215 60 9		341
101 IT-16	1660/ AI	5613237	5408 15 8		382	157 F-VA 230	/ V2A	5407294	5215 55 2		341
101 IV	2060/ AI	5674238	5408 55 5		384	157 F-VA 230 35	/ V2A	5784982	5215 55 5		341
101 IV-16	1660/ AI	5613299	5408 55 7		384	157 F-VA 280	/ V2A	5812234	5215 57 9		341
101 IW-M10	2060/ AI	5673811	5408 68 7		383	157 F-VA 280 35	/ V2A	5785019	5215 58 2		341
				/100 pc.		157 F-VA 410	/ V2A	5812357	5215 59 5		341
101 J1000	1000/ AI	5034810	5401 97 0		332	157 F-VA 410 35	/ V2A	5785026	5215 59 8		341
				/pc.		157 FX-AL	/ AI	5531791	5215 87 5		342
101 MA-16	1691	5613442	5408 99 6		386	157 FX-CU	/ Cu	5531852	5215 87 9		342
101 R-16	1681	5613435	5408 99 4		385	157 GB-M8	260/ V2A	5894223	5202 56 9		344
				/100 pc.		157 I-CU	/ Cu	5812593	5215 74 9		342
101 RH-16	Black/ PA	5674924	5408 10 1		384	157 IK-VA	/ V2A	5812531	5215 66 8		342
101 ST	M16	5428534	5402 89 1		335	157 I-VA	/ V2A	5407355	5215 62 5		342
101 ST	M16	5428534	5402 89 1		383	157 L-CU	212/ Cu	5812111	5215 47 1		343
101 VL1500	1500/ AI	5105619	5401 98 0		332	157 LK-CU	212/ Cu	5811930	5215 38 2		343
101 VL2000	2000/ AI	5107774	5401 98 3		332	157 LK-VA	212/ V2A	5811879	5215 37 4		343



Type	Dimensions/Colour/Div.	GTIN	Art. no.	Price	Page	Type	Dimensions/Colour/Div.	GTIN	Art. no.	Price	Page
157 L-VA	212/ V2A	5407171	5215 43 9	/100 pc.	343	204 KS-2000	2000/ St / F	5901457	5430 01 1	/pc.	375
157 NB-VA	260/ V2A	5903673	5215 27 7		343	204 KS-2500	2500/ St / F	5901570	5430 06 2		316
157 ND-VA	260/ V2A	5903796	5215 30 7		344	204 KS-2500	2500/ St / F	5901570	5430 06 2		375
159 K-VA	/ V2A	5813255	5216 81 8		344	205 B-M10 VA	M10/ V4A	5900498	5420 00 8		322
159 VA-V	/ V2A	5407959	5217 07 5		344	205 B-M12 VA	M12/ V4A	5629290	5420 01 6		322
163 100 CU	100/ Cu	5409939	5223 60 1		350						
163 100 FT	100/ St / FT	5409519	5223 10 5		350	213 1000 DIN	1000/ St / FT	5373575	5003 00 8		316
163 150 FT	150/ St / FT	5409632	5223 15 6		350	213 1000 M	1000/ St / FT	5373995	5003 25 3		316
163 200 FT	200/ St / FT	5409755	5223 20 2		350	213 1500 DIN	1500/ St / FT	5373636	5003 01 6		316
163 70 FT	70/ St / FT	5409458	5223 07 5		350	213 1500 F	1500/ St / FT	5374718	5003 77 6		317
						213 1500 M	1500/ St / FT	5374053	5003 26 1		316
165 B 100	/ St / FT	5408970	5218 82 9		346	213 2000 DIN	2000/ St / FT	5373698	5003 02 4		316
165 B 60	/ St / FT	5408918	5218 81 0		346	213 2000 F	2000/ St / FT	5374770	5003 78 4		317
165 KR	/ PE	5409038	5218 86 1		345	213 2000 M	2000/ St / FT	5374114	5003 28 8		316
165 KRB SO		5952213	5218 97 7		346	213 2500 DIN	2500/ St / FT	5373759	5003 03 2		316
165 MBG HFL	Black/ PP	5623052	5218 88 5	/pc.	345	213 2500 M	2500/ St / FT	5374176	5003 29 6		316
						213 3000 DIN	3000/ St / FT	5373810	5003 04 0		316
165 MBG UH	Black/ PP	5674580	5218 88 2		345	213 3000 M	3000/ St / FT	5374237	5003 31 8		316
165 MBG UH	Black/ PP	5674580	5218 88 2		390						
165 MBG-10	/ PA/PE	5408734	5218 67 5	/100 pc.	345	219 20 BP CU	1500/ St / Cu	5371717	5000 50 5		313
165 MBG-10 200	/ PE	5814634	5218 75 6		345	219 20 BP FT	1500/ St / FT	5371892	5000 94 7		312
165 MBG-8	/ PA/PE	5408857	5218 69 1		345	219 20 BP V4A	1000/ V4A	5740650	5000 85 8		312
165 MBG-8 200	/ PE	5904519	5218 74 8		345	219 20 BP V4A	1500/ V4A	5371830	5000 86 6		312
165 NBK 55	55/ PA	5904274	5218 31 4		346	219 20 OMEX FT	1500/ St / FT	5371298	5000 01 7		313
165 OBG-8	/ PE	5408796	5218 68 3		345	219 20 OMEX FT	2000/ St / FT	5371472	5000 20 3		313
165 R-8-10	/ PE	5625889	5218 99 7		346	219 20 ST FT	1000/ St / FT	5018049	5000 74 2		312
						219 20 ST FT	1500/ St / FT	5814450	5000 75 0		312
						219 25 BP FT	1500/ St / FT	5371953	5000 95 5		312
166 LS 70	70/ St / FT	5410416	5226 57 0		350	219 25 OMEX FT	1500/ St / FT	5371359	5000 02 5		313
						219 25 ST FT	1500/ St / FT	5111047	5000 76 9		312
168 8-10 M6	M6/ Zn / G	5411499	5229 16 2		349						
168 DIN 30	56/ Zn / G	5411734	5229 48 0		350						
168 DIN-K-M8	M8/ Zn / G	5412151	5229 83 9		349						
168 DIN-K-M8	M8/ Zn / Cu	5411611	5229 38 3		350	223 DIN MS	/ Zn / Cu	5423676	5335 25 6	/100 pc.	372
168 FL30-M6	56/ Zn / VZ	5411673	5229 46 4		350	223 DIN ZN	/ Zn / G	5423614	5335 20 5		372
168 FL40-M8	66/ TG / FT	5411970	5229 55 3		350	223 O DIN MS	/ Zn / Cu	5890119	5335 16 7		372
168 ZN-M6	M6/ Zn / Cu	5411550	5229 36 7		350	223 O DIN ZN	/ Zn / G	5890058	5335 14 0		372
172 AR	/ Al	5409090	5218 92 6		369	226 8-10	/ St / FT	5424215	5336 00 7		372
						226 CU	/ Cu	5424277	5336 02 3		373
176 A 100	100/ TG / F	5410652	5227 10 0		351	226 VA	/ V2A	5424338	5336 05 8		372
176 A 150	150/ TG / F	5410713	5227 15 1		351	226 ZV CU	/ V2A	5424451	5336 09 0		373
176 A 65	65/ TG / F	5410539	5227 07 0		351	226 ZV VA	/ Cu	5424390	5336 07 4		373
176 A 80	80/ TG / F	5410591	5227 08 9		351						
						233 8	/ St / FT	5424635	5336 30 9		373
177 20 CU	/ PA	5904991	5207 74 6		348	233 A VA	/ V2A	5424871	5336 45 7		373
177 20 KL	/ PA	5009726	5207 45 1		348	233 A ZV	/ Cu	5424932	5336 50 3		374
177 20 M8	/ PA	5404897	5207 44 4		348	233 VA	/ V2A	5424758	5336 34 1		373
177 20 VA B-HD	/ V2A	5915836	5207 90 1		347	233 ZV	/ V2A	5424819	5336 37 6		373
177 20 VA M6	/ V2A	5404774	5207 33 9	/100 pc.	347	237 N CU	/ Cu	5453673	5328 28 4		359
177 20 VA M8	/ V2A	5404835	5207 34 7		347	237 N FT	/ St / F	5453611	5328 20 9		359
177 20 VA-VK M6	/ V2A / Cu	5904878	5207 80 0		347						
177 20 VA-VK M8	/ V2A / Cu	5904939	5207 81 9		347	239	/ Zn / G	5423195	5329 07 8		359
177 30 CU	/ PA	5905059	5207 75 4		348						
177 30 M8	/ PA	5404958	5207 46 0		348	244	/ Zn / G	5417316	5311 03 9		359
177 35 VA M6	/ V2A	5735762	5207 34 2		347						
177 55 CU	/ PA	5905110	5207 76 2		348	245 8-10 CU	/ Cu	5417439	5311 15 2		360
177 55 M8	/ PA	5405016	5207 48 7		348	245 8-10 FT	/ St / FT	5417378	5311 10 1		359
177 B-HD20	/ PA	5336433	5207 85 1		348						
177 B-HD30	/ PA	5334811	5207 87 8		348	247 8-10 CU	/ Cu	5417552	5311 26 8		360
177 U	Light grey/ PP	5069546	5207 37 1		347	247 8-10 FT	/ St / FT	5417491	5311 20 9		360
194	Grey M8/ PA	5404651	5207 25 8		348	249 6-10 CU	40/ Cu	5816591	5311 41 7		356
						249 6-10 ST	40/ St / FT	5816584	5311 41 0		355
194 K	Grey M8/ PA	5110392	5207 26 6		348	249 8-10 ALU	44/ Al	5417736	5311 51 9		355
						249 8-10 ALU-OT	44/ Al	5466192	5311 58 5		305
				/kg		249 8-10 ALU-OT	44/ Al	5466192	5311 58 5		352
198 60	2160	5399674	5101 06 9		377	249 8-10 ALU-OT	44/ Al	5466192	5311 58 5		367
						249 8-10 CU	40/ Cu	5417798	5311 52 7		355
				/100 pc.		249 8-10 CU-OT	40/ Cu	5835394	5311 53 0		301
199 DIN	M8/ St / FS	5405252	5208 01 7		351	249 8-10 CU-OT	40/ Cu	5835394	5311 53 0		305
						249 8-10 CU-OT	40/ Cu	5835394	5311 53 0		352
200 V4A-1500	1500/ V4A	5751571	5420 50 4		315	249 8-10 CU-OT	40/ Cu	5835394	5311 53 0		367
200 V4A-1500	1500/ V4A	5751571	5420 50 4		333	249 8-10 ST	40/ St / FT	5417675	5311 50 0		355
200 V4A-1500	1500/ V4A	5751571	5420 50 4		375	249 8-10 ST-OT	40/ St / FT	5737063	5311 50 3		305
200 V4A-2000	2000/ V4A	5331575	5420 53 9		315	249 8-10 ST-OT	40/ St / FT	5737063	5311 50 3		352
200 V4A-2000	2000/ V4A	5331575	5420 53 9		333	249 8-10 ST-OT	40/ St / FT	5737063	5311 50 3		367
200 V4A-2000	2000/ V4A	5331575	5420 53 9		375	249 8-10 VA	40/ V2A	5417910	5311 55 1		355
						249 8-10 VA-OT	40/ V2A	5835349	5311 55 4		301
204 KL-1500	/ St	5430575	5430 15 1		316	249 8-10 VA-OT	40/ V2A	5835349	5311 55 4		305
204 KL-1500	/ St	5430575	5430 15 1		375	249 8-10 VA-OT	40/ V2A	5835349	5311 55 4		352
				/pc.		249 8-10 VA-OT	40/ V2A	5835349	5311 55 4		367
204 KS-2000	2000/ St / F	5901457	5430 01 1		316	249 8-10 ZV	44/ Cu	5417859	5311 53 5		355

# Type listing

Structure of the GTIN: Country code **40** Manufacturer code **1219** Individual GTIN **5647589**

Type	Dimensions/Colour/Div.	GTIN	Art. no.	Price	Page	Type	Dimensions/Colour/Div.	GTIN	Art. no.	Price	Page
249 8-10X16 VA	/ V2A	5925446	5311 59 0	/100 pc.	356	264 CU	/ Cu	5420378	5316 55 3	/100 pc.	367
249 B ALU	44/ Al	5452058	5311 71 3		355	267	/ St / FT	5420132	5316 30 8		365
249 B ST	40/ FT	5451990	5311 70 5		306	267 VA	/ V2A	5420194	5316 32 4		366
249 VA-OT	/ V2A	5693789	5311 57 3		353	269 8-10	/ Zn / G	5420439	5317 01 0		363
249 VA-OT	/ V2A	5693789	5311 57 3		368	269 MS	/ Zn / Cu	5420491	5317 05 3		363
250	/ St / FT	5418696	5312 90 6		321	270 8-10 CU	/ Cu	5420675	5317 25 8		364
250	/ St / FT	5418696	5312 90 6		360	270 8-10 FT	/ St / FT	5420552	5317 20 7		363
250 A-BO	25/ St / F	5806530	5313 06 6		321	270 8-10 VA	/ V2A	5893158	5317 20 8		363
250 A-FT	40/ St / FT	5740537	5313 01 5		321	271 8-10	/ St / FT	5420798	5317 40 1		364
250 AS-FT	20/ St / FT	5543015	5313 03 1		321	271 8-10 VA	/ V2A	5850861	5317 48 1		364
250 A-VA	40/ V2A	5740476	5313 02 3	321	271 CU	/ Cu	5420910	5317 45 2	364		
250 V4A	/ V4A	5700876	5312 92 5	360	272 14	/ TG / FT	5421092	5318 14 9	363		
250 V4A	/ V4A	5700876	5312 92 5	360	272 8	/ TG / FT	5421030	5318 08 4	363		
250 VA	/ V2A	5418757	5312 92 2	360	273 8-10	/ St / FT	5420613	5317 22 3	364		
250 VA	/ V2A	5418757	5312 92 2	360	273 CU	/ Cu	5420736	5317 27 4	364		
251 8-10	/ St / FT	5417972	5312 03 5	361	274 8-10	/ St / FT	5420859	5317 42 8	365		
251 CU	/ Cu	5418030	5312 13 2	361	274 CU	/ Cu	5420972	5317 47 9	365		
252 8-10 CU	/ Cu	5418214	5312 41 8	320	280 8-10	/ Zn / G	5421276	5320 01 1	368		
252 8-10 CU	/ Cu	5418214	5312 41 8	362	280 VK	/ Zn	5421337	5320 05 4	368		
252 8-10 FT	/ St / FT	5418092	5312 31 0	320	287	/ Al	5421573	5320 70 4	369		
252 8-10 FT	/ St / FT	5418092	5312 31 0	361	287 CU	/ Cu	5421511	5320 69 0	369		
252 8-10 V4A	/ V4A	5700869	5312 31 8	320	288 DIN	/ Al	5421634	5320 71 2	369		
252 8-10 V4A	/ V4A	5700869	5312 31 8	362	292 DIN	/ TG / F	5424994	5340 01 2	374		
252 8-10X16 CU	/ Cu	5418276	5312 44 2	362	301 CU-100	/ Cu	5426370	5350 70 0	370		
252 8-10X16 CU	/ Cu	5418276	5312 44 2	362	301 CU-110	/ Cu	5426431	5350 71 9	370		
252 8-10X16 FT	/ St / FT	5418153	5312 34 5	362	301 CU-120	/ Cu	5426493	5350 72 7	370		
252 8-10x16 V4A	/ V4A	5893103	5312 34 6	320	301 CU-80	/ Cu	5426257	5350 68 9	370		
252 8-10x16 V4A	/ V4A	5893103	5312 34 6	362	301 CU-90	/ Cu	5426318	5350 69 7	370		
252 8-10xFL30 FT	/ St / F	5418399	5312 65 5	321	301 DIN-100	/ St / FS	5425717	5350 10 7	370		
252 8-10xFL30 FT	/ St / F	5418399	5312 65 5	360	301 DIN-110	/ St / FS	5425779	5350 11 5	370		
252 8-10xFL30V4A	/ V4A	5893141	5312 65 6	321	301 DIN-120	/ St / FS	5425830	5350 12 3	370		
252 8-10xFL30V4A	/ V4A	5893141	5312 65 6	360	301 DIN-80	/ St / FS	5425595	5350 08 5	370		
253 10X16	/ St / F	5418573	5312 80 9	320	301 DIN-90	/ St / FS	5425656	5350 09 3	370		
253 10X16	/ St / F	5418573	5312 80 9	362	301 S-100	/ St / FS	5426974	5351 05 7	370		
253 8X8	/ St / F	5418337	5312 60 4	319	301 S-120	/ St / FS	5427032	5351 07 3	370		
253 8X8	/ St / F	5418337	5312 60 4	361	301 S-AL-100	/ Al	5890652	5351 35 9	370		
254 DIN 8-10 CU	/ Cu	5419112	5314 13 5	361	301 S-AL-120	/ Al	5890713	5351 37 5	370		
254 DIN 8-10 FT	/ St / FT	5418993	5314 03 8	361	301 S-CU-100	/ Cu	5427216	5351 45 6	371		
255 30	52/ St / FT	5419174	5314 51 8	319	301 S-CU-120	/ Cu	5427278	5351 47 2	371		
255 A-FL30 FT	60/ St / FT	5419235	5314 53 4	319	301 S-VA-100	/ V2A	5427094	5351 25 1	371		
256 A-DIN 30 FT	60/ St / FT	5419471	5314 65 8	319	301 S-VA-120	/ V2A	5427155	5351 28 6	371		
256 A-DIN 30 V4A	60/ V4A	5893080	5314 65 9	319	301 V	/ St / FS	5426790	5350 86 7	369		
256 A-DIN 30 VA	60/ V2A	5925873	5314 72 0	319	301 V-CU	/ Cu	5426851	5350 88 3	370		
256 A-DIN 40 FT	80/ St / FT	5419532	5314 66 6	319	301 V-VA	/ V2A	5426912	5350 90 5	370		
256 DIN 30 FT	60/ St / FT	5419297	5314 61 5	319	303 DIN-1	/ St / FT	5399971	5102 11 1	371		
256 DIN 30 V4A	60/ V4A	5893097	5314 61 6	319	303 DIN-1 1/2	/ St / FT	5400097	5102 15 4	371		
256 DIN 40 FT	80/ St / FT	5419358	5314 62 3	319	303 DIN-1 1/4	/ St / FT	5400035	5102 13 8	371		
259 8-10	/ TG / FT	5419716	5315 50 6	358	303 DIN-1/2	/ St / FT	5399858	5102 07 3	371		
259 A FT	/ St / FT	5740414	5315 51 4	322	303 DIN-2	/ St / FT	5400158	5102 19 7	371		
259 A FT 8-OT	/ St / FT	5737070	5315 51 7	368	303 DIN-2 1/2	/ St / FT	5400219	5102 21 9	371		
259 A ST	/ St	5237198	5315 55 7	322	303 DIN-3	/ St / FT	5400271	5102 23 5	371		
259 A VA	/ V2A	5740353	5315 52 2	322	303 DIN-3 1/2	/ St / FT	5400332	5102 25 1	371		
260 8	/ Zn / G	5419839	5315 70 0	359	303 DIN-3/4	/ St / FT	5399919	5102 08 1	371		
260 8-10 MS	/ CuZn / Cu	5419778	5315 65 4	359	303 DIN-3/8	/ St / FT	5399797	5102 05 7	371		
262	/ St / FT	5419891	5316 01 4	366	303 DIN-4	/ St / FT	5400394	5102 27 8	371		
262 A-DIN CU	/ Cu	5420071	5316 25 1	366	311 N-ALU 16	/ Al	5631392	3049 34 5	326		
262 A-DIN FT	/ St / FT	5420019	5316 21 9	366	311 N-ALU 16	/ Al	5631392	3049 34 5	374		
262 CU	/ Cu	5419952	5316 15 4	366	311 N-ALU 8-10		5631576	3049 25 6	326		
262 ZM	/ St / FT	5818359	5316 17 0	366	311 N-ALU 8-10		5631576	3049 25 6	374		
264	/ St / F	5420316	5316 51 0	367	311 N-CU 16	/ Cu	5631514	3049 30 2	326		
					311 N-CU 16	/ Cu	5631514	3049 30 2	374		
					311 N-CU 8-10	/ Cu	5631699	3049 20 5	326		
					311 N-CU 8-10	/ Cu	5631699	3049 20 5	374		
					311 N-VA 16	/ V2A	5631453	3049 32 9	326		
					311 N-VA 16	/ V2A	5631453	3049 32 9	374		
					311 N-VA 8-10	/ V2A	5631637	3049 22 1	326		
					311 N-VA 8-10	/ V2A	5631637	3049 22 1	374		
					319 10	/ TG / F	5421931	5325 31 5	367		

02\_TBS\_Masterkatalog\_Länder\_2012 / en / 10/04/2012 (LLExpport\_01433)

Type	Dimensions/Colour/Div.	GTIN	Art. no.	Price	Page	Type	Dimensions/Colour/Div.	GTIN	Art. no.	Price	Page
319 8	/ TG / F	5421870	5325 30 7	/100 pc.	367	910 N 6x60 GRW	660/ PA	5228974	2349 07 8	/100 pc.	378
						910 N 8x40 GRW	840/ PA	5229032	2349 08 6		378
324 S-CU	/ Cu	5422532	5326 33 8		368	925 1	7031,7-33,7 / St / G	5385455	5040 11 6		304
324 S-FT	/ St / FT	5422419	5326 30 3		368	925 1 1/2	8846,3-48,3 / St / G	5385578	5040 15 9		304
324 S-VA	/ V2A	5422471	5326 31 1		368	925 1 1/4	8140,4-42,4 / St / G	5385516	5040 13 2		304
330 K	/ PA	5401599	5201 10 1		336	925 1/2	5619,3-21,3 / St / G	5385332	5040 07 8		304
						925 1/4	4811,5-13,5 / St / G	5385219	5040 03 5		304
						925 3/4	6224,9-26,9 / St / G	5385394	5040 09 4		304
						925 3/8	5215,2-17,2 / St / G	5385271	5040 05 1		304
356 100	10010	5230595	2360 10 1	/pc.	326	927 0	/ CuZn / N	5388517	5057 50 7		303
356 100	10010	5230595	2360 10 1		377	927 1	/ V2A	5388579	5057 51 5		303
356 50	5010	5230533	2360 05 5		326	927 2	/ V2A	5388630	5057 52 3		303
356 50	5010	5230533	2360 05 5		377	927 2 6-K	/ V2A	5699651	5057 59 9		392
						927 4	/ V2A	5388692	5057 55 8		303
364	297/ St / FT	5244219	3051 01 3		378	927 BAND-VA	230,3/ V2A	5805458	5057 92 2	/100 m	303
						927 SCH-K-VA	/ V2A	5805519	5057 93 0	/100 pc.	303
366 35	35/ St / FT	5388876	5059 35 6	/100 pc.	326	928	240/ CuZn / N	5385936	5040 50 7		304
366 50	50/ St / FT	5389057	5059 49 6		326	937 50	100/ St / FT	5385998	5043 01 8		306
370 H	55/ St / FT	5382690	5025 20 6		325	939	150/ St / G	5386056	5043 10 7		306
470 4-16	/ CuZn / N	5389231	5064 01 5		306	942 11	448-11 / Cu / N	5384557	5038 01 4		304
						942 15	5013-15 / Cu / N	5384618	5038 03 0		304
480 180		5412571	5240 03 4	/pc.	288	942 18	5216-18 / Cu / N	5384670	5038 05 7		304
480 250		5412755	5240 07 7		288	942 22	5519-22 / Cu / N	5384731	5038 07 3		304
480 350		5412694	5240 06 9		288	942 28	6324-28 / Cu / N	5384793	5038 08 1		304
						942 35	7130-35 / Cu / N	5384854	5038 11 1		304
481		5412816	5240 08 5		288	942 43	8139-43 / Cu / N	5384915	5038 13 8		304
						942 49	8644-49 / Cu / N	5384977	5038 15 4		304
482		5412632	5240 05 0		289	950 Z 1	6631,5-34,5 / Zn / G	5386353	5050 11 1		304
						950 Z 1 1/2	8446,5-49,5 / Zn / G	5386476	5050 15 4		304
484 M12	13/ St / F	5412991	5240 22 0		288	950 Z 1 1/4	7840,5-43,5 / Zn / G	5386414	5050 13 8		304
484 M16	17/ St / F	5413059	5240 23 9		288	950 Z 1 3/4	8851-54 / Zn / G	5386537	5050 17 0		304
484 M20	21/ St / F	5413110	5240 24 7		288	950 Z 1/2	5420-22,5 / Zn / G	5386230	5050 07 3		304
484 M24	25/ St / F	5413172	5240 25 5		288	950 Z 1/4	4512-14 / Zn / G	5386117	5050 03 0		304
						950 Z 2	9658,5-61,5 / Zn / G	5386599	5050 19 7		304
485 M10	11/ St / F	5413233	5240 30 1		288	950 Z 3/4	6125-28 / Zn / G	5386292	5050 08 1		304
485 M12	13/ St / F	5413295	5240 32 8		288	950 Z 3/8	5015,5-17,5 / Zn / G	5386179	5050 05 7		304
485 M16	17/ St / F	5413356	5240 33 6		288	951	120/ V2A	5386650	5051 50 9		305
485 M20	21/ St / F	5413417	5240 34 4		288	952 Z 1	7730,5-33,5 / St / FT	5386957	5052 11 4		305
						952 Z 1 1/2	9445,5-48,5 / St / FT	5387077	5052 15 7		305
555 7.6x380 SWUV	7.6 x 380 102/ PA	5896920	2332 78 4	/100 pc.	393	952 Z 1 1/4	8739,5-42,5 / St / FT	5387015	5052 13 0		305
						952 Z 1/2	6518,5-21,5 / St / FT	5386834	5052 07 6		305
708 30 HG	52/ St / G	5383659	5030 23 4			952 Z 2	10557-60 / St / FT	5387190	5052 18 1		305
708 30 SP	52/ St / G	5383413	5030 02 1		325	952 Z 3/4	7124-27 / St / FT	5386896	5052 09 2		305
708 40 HG	52/ St / G	5383710	5030 24 2			985 M6 25	25,4,3/ St / G	5250395	3133 02 8		378
710 30	52/ St / G	5383055	5028 03 5		325	985 M6 35	35,4,3/ St / G	5250456	3133 03 6		378
710 40	62/ St / G	5383116	5028 04 3		325	985 M8 35	3510/ St / G	5250579	3133 23 0		378
733 16 VA	14-16 6,5 x 10/ V2A	5116714	1362 01 1		352	1801 AH	Grey/ PS	5378617	5015 70 7	/pc.	297
733 21 VA	19-21 6,5 x 10/ V2A	5116837	1362 04 6		354	1801 KL1	212/ CuZn	5378730	5015 72 3		297
831 30	54/ St / FT	5383833	5032 03 2		324	1801 KL2	430/ CuZn	5378976	5015 80 4		297
831 30 M6	54/ St / FT	5383956	5032 23 7		324	1801 KL3	645/ CuZn	5379034	5015 81 2		297
831 40	65/ St / FT	5383895	5032 04 0		324	1801 RK25	/ St / G	5378853	5015 75 8		296
831 40 M6	65/ St / FT	5384014	5032 24 5		324	1801 RK30	/ St / G	5378792	5015 73 1		296
						1801 RK40	/ St / G	5455837	5015 77 4		297
832 30	55/ St / FT	5384137	5032 53 9		324	1801 RK95	/ St / G	5378914	5015 76 6		296
832 40	65/ St / FT	5384199	5032 54 7		324	1801 SCH	Grey/ PS	5378679	5015 71 5		297
						1801 VDE	Grey/ CuZn	5378556	5015 65 0		296
833 35	60/ St / FT	5384434	5033 03 9		324	1802 10 CU	40/ Cu	5002260	5015 84 2		301
835	/ St / FT	5433750	5033 20 9		324	1802 10 VA	40/ V2A	5002284	5015 86 6		301
						1802 12 CU	40/ Cu	5699354	5015 84 4		301
						1802 14 CU	40/ Cu	5699361	5015 84 7		301
853 200	200/ Cu	5885573	5331 00 8		369	1802 20 CU	40/ Cu	5699408	5015 84 9		301
853 300	300/ Cu	5423379	5331 01 3		369	1802 5 CU	40/ Cu	5002253	5015 83 0		301
853 400	400/ Cu	5885580	5331 01 7		369	1802 5 VA	40/ V2A	5002277	5015 85 4		301
						1802 6 CU	40/ Cu	5699330	5015 83 2		301
856	/ Cu	5423430	5331 50 1		369	1802 8 CU	40/ Cu	5699347	5015 83 6		301
						1802 AH 10	/ V2A	5033677	5015 88 4		301
						1802 AH 5	/ V2A	5033615	5015 88 0		301
910 N 10x50 GRW	1050/ PA	5229155	2349 10 8		378	1802 KL	/ V2A	5033738	5015 89 0		301
910 N 12x60 GRW	1260/ PA	5229216	2349 12 4		378	1804	/ CuZn	5378495	5015 55 3		299
910 N 5x25 GRW	525/ PA	5228851	2349 04 3		378	1804 AP	/ PE	5477839	5015 55 7		299
910 N 6x30 GRW	630/ PA	5228912	2349 05 1		378						

# Type listing

Structure of the GTIN: Country code **40** Manufacturer code **1219** Individual GTIN **5647589**

Type	Dimensions/Colour/Div.	GTIN	Art. no.	Price	Page	Type	Dimensions/Colour/Div.	GTIN	Art. no.	Price	Page
1804 UP	/ CuZn	5378433	5015 54 5	/pc.		2710 20	84/ St / FT	5372370	5001 21 8	/pc.	318
						2710 25	89/ St / FT	5372431	5001 22 6		318
1805 2 FT	200110/ St / FT	5379096	5016 02 9		302						
1805 2 FT	200110/ St / FT	5379096	5016 02 9		323	2730 20 FT	84/ St / FT	5372554	5001 40 4		318
1805 2 VA	200110/ V4A	5922216	5016 09 6		323	2730 20 VA	84/ V2A	5635475	5001 36 6		318
1805 2 VA	200110/ V4A	5922216	5016 09 6		302	2730 25 FT	89/ St / FT	5372615	5001 41 2		318
1805 4 FT	302212/ St / FT	5379157	5016 03 7		302						
1805 4 FT	302212/ St / FT	5379157	5016 03 7		323	2745 20 MS	/ CuZn / Cu	5372851	5001 56 0		318
1805 4 VA	302212/ V4A	5800354	5016 11 8		323	2745 20 MS	/ CuZn / Cu	5372851	5001 56 0		374
1805 4 VA	302212/ V4A	5800354	5016 11 8		302						
1805 6 FT	404314/ St / FT	5379218	5016 04 5		302	2760 20 FT	101/ St / FT	5372912	5001 64 1		318
1805 6 FT	404314/ St / FT	5379218	5016 04 5		323	2760 20 V4A	101/ V4A	5862697	5001 63 3		318
1805 6 VA	404314/ V4A	5922278	5016 12 6		323	2760 20 VA	101/ V2A	5635239	5001 61 7		318
1805 6 VA	404314/ V4A	5922278	5016 12 6		302	2760 25 FT	110/ St / FT	5372974	5001 66 8		318
						2760 25 V4A	110/ V4A	5901259	5001 67 2		318
1807	/ Al	5379270	5016 14 2		323					/pc.	
						2760 B-20 FT	101/ St / FT	5754879	5001 74 9		318
1808	/ CuZn	5378075	5015 01 4		299	2760 B-20 VA	101/ V2A	5752653	5001 62 5		318
1809	Grey/ CuZn	5378259	5015 07 3		297					/100 pc.	
1809 30 AH	Grey/ PS	5800118	5015 20 0		298	5000	/ St / F	5415695	5304 00 8		356
1809 A	Black/ V2A	5959427	5015 11 1		300						
1809 BG	Grey/ CuZn	5378372	5015 50 2		298	5001 DIN-FT	/ St / FT	5415879	5304 10 5		356
1809 M	Grey/ CuZn	5378310	5015 08 1		298	5001 DIN-FT+VA	/ St / FT	5858034	5304 10 7		356
1809 UP	/ CuZn	5378198	5015 06 5			5001 N-Cu	/ Cu	5817574	5304 17 2		357
						5001 N-FT	/ St / FT	5817512	5304 16 4		357
1810	/ St / F	5378136	5015 05 7		298	5001 N-VA	/ V2A	5892809	5304 17 6		357
1811	250/ St / FT	5377894	5014 01 8		323	5001 ZN-CU	/ Zn / Cu	5415930	5304 11 3	/100 pc.	356
1811 L	400/ St / FT	5377955	5014 02 6		323						
						5002 DIN-FT	/ St / FT	5416050	5304 20 2		356
1813 DIN	/ St / FT	5378013	5014 21 2		323	5002 N-VA	/ V2A	5892847	5304 27 0		357
1813 KL	/ St / FT	5901938	5014 42 5		322						
1814 FT	/ St / FT	5105015	5014 46 8		322	5003	/ TG / FT	5416234	5304 31 8	/100 pc.	357
1814 ST	/ St	5105077	5014 47 6		322						
						5004 DIN-FT 12	/ TG / FT	5416357	5304 40 7		362
1816 F-1000X1000	/ St / FT	5376996	5009 23 5		317	5004 DIN-FT 20	/ TG / FT	5416418	5304 50 4		362
1816 F-500X1000	/ St / FT	5376934	5009 22 7		317						
1816 F-500X500	/ St / FT	5376873	5009 21 9		317	5005 DIN-FT	/ St / F	5416470	5304 60 1		358
						5005 N-FT	/ St / FT	5817758	5304 66 0		358
1818	/ St / FT	5377719	5012 01 5	/100 pc.	322	5009	/ St / F	5416951	5304 97 0		358
				/pc.		5010 20 FT	/ St / FT	5503057	5304 52 0		363
1819 20	/ TG / FT	5242710	3041 20 4		313						
1819 20BP	/ TG / FT	5242772	3041 21 2		313	5011	/ St / FT	5417071	5304 99 7		322
1819 25	/ TG / FT	5242833	3041 25 5		313	5011	/ St / FT	5417071	5304 99 7		358
1819 25BP	/ TG / FT	5242956	3041 95 6		313						
						5011 VA M10	/ V4A	5629115	5334 93 4		323
1820 20	/ St	5243137	3042 20 0		314	5011 VA M10	/ V4A	5629115	5334 93 4		358
1820 25	/ St	5243199	3042 25 1		314	5011 VA M12	/ V4A	5959663	5334 94 2		323
						5011 VA M12	/ V4A	5959663	5334 94 2		358
2056N SAS 12 VA	8-12 / V2A	5432432	1167 01 4		306					/100 m	
2056N SAS 16 VA	12-16 / V2A	5432494	1167 02 2		306						
2056N SAS 22 VA	16-22 / V2A	5432555	1167 03 0		306	5052 DIN 20X2.5	20 x 2,5/ St / FT	5680468	5019 34 0		310
2056N SAS 28 VA	22-28 / V2A	5432616	1167 04 9		306	5052 DIN 20X2.5	20 x 2,5/ St / FT	5680468	5019 34 0		330
2056N SAS 8 VA	4-8 / V2A	5432371	1167 00 6		306	5052 DIN 25X3	25 x 3/ St / FT	5694007	5019 34 2		310
						5052 DIN 25X3	25 x 3/ St / FT	5694007	5019 34 2		330
						5052 DIN 30X3	30 x 3/ St / FT	5694014	5019 34 4		310
2066 2M F	25 x 12/ St / F	5046516	1117 02 5	/100 m	306	5052 DIN 30X3	30 x 3/ St / FT	5694014	5019 34 4		330
2066 2M FS	25 x 12/ St / FS	5046578	1117 03 3		306	5052 DIN 30X3.5	30 x 3,5/ St / FT	5680475	5019 34 5		310
						5052 DIN 30X3.5	30 x 3,5/ St / FT	5680475	5019 34 5		330
						5052 DIN 30X3.5	30 x 3,5/ St / FT	5680482	5019 34 7		310
						5052 DIN 30X3.5	30 x 3,5/ St / FT	5680482	5019 34 7		330
2500 20	/ St	5243311	3043 20 7	/pc.	314	5052 DIN 30X4	30 x 4/ St / FT	5680499	5019 35 0		310
2500 25	/ St	5243373	3043 25 8		314	5052 DIN 30X4	30 x 4/ St / FT	5680499	5019 35 0		330
						5052 DIN 40X4	40 x 4/ St / FT	5680505	5019 35 5		310
2510 20	/ St	5717492	3043 31 2		314	5052 DIN 40X4	40 x 4/ St / FT	5680505	5019 35 5		330
						5052 DIN 40X5	40 x 5/ St / FT	5680512	5019 36 0		310
2520 20	/ St	5243793	3043 70 3		314	5052 DIN 40X5	40 x 5/ St / FT	5680512	5019 36 0		330
2520 25	/ St	5243854	3043 75 4		314	5052 V2A 30X3.5	30 x 3,5/ V2A	5800415	5018 50 1		310
						5052 V2A 30X3.5	30 x 3,5/ V2A	5800415	5018 50 1		330
2530 20	/ St	5243557	3043 40 1		314	5052 V4A 30X3.5	30 x 3,5/ V4A	5800477	5018 70 6		310
2530 25	/ St	5243618	3043 45 2		314	5052 V4A 30X3.5	30 x 3,5/ V4A	5800477	5018 70 6		330
						5052 V4A 30X3.5	30 x 3,5/ V4A	5022015	5018 73 0		310
2531 20	/ St	5642312	3043 90 8		314	5052 V4A 30X3.5	30 x 3,5/ V4A	5022015	5018 73 0		330
2535 20	/ St	5453796	3043 91 6		315					/pc.	
2535 25	/ St	5453970	3044 91 2		315						
2536 20	/ St	5643036	3044 90 4		315	5700 A DIN		5400936	5106 02 8		376
2536 25	/ St	5642978	3044 83 1		315	5700 DIN		5400875	5106 00 1		376
						5800 VA	/ V2A	5900436	5106 14 1		376
						5800 VZ	/ St / FS	5900375	5106 13 3		376

02\_TBS\_Masterkatalog\_Länder\_2012 / en / 10/04/2012 (LLEExport\_01433)

Type listing

Type	Dimensions/Colour/Div.	GTIN	Art. no.	Price	Page	Type	Dimensions/Colour/Div.	GTIN	Art. no.	Price	Page
5900	/ st	5244813	3059 00 6	/pc.	378	FL 20-CU	20 x 2,5/ Cu	5382331	5021 80 4	/100 m	310
ASP-V11E1 4		5917717	5083 08 7		257	FL 20-CU	20 x 2,5/ Cu	5382331	5021 80 4		330
ASP-V24T 4		5917595	5083 06 0		257						
B 33020	228/ CuZn	6049080	6404 00 6	/100 pc.	306	FLD 110		5578413	5098 64 6	/pc.	270
B 33021	2610/ CuZn	6049202	6404 01 4		306	FLD 12		5578376	5098 60 3		269
						FLD 2-110		5578512	5098 85 9		272
						FLD 2-12		5578444	5098 80 8		271
						FLD 2-24		5578451	5098 81 6		271
						FLD 24		5578383	5098 61 1		269
						FLD 2-48		5578468	5098 82 4		271
C 25-B+C 0		5919391	5095 60 3	/pc.	164	FLD 2-5		5578529	5098 86 7		271
C 25-B+C 0		5919391	5095 60 3		195	FLD 48		5578390	5098 63 0		269
C 25-B+C 1		5542957	5095 60 6		156	FLD 5		5578369	5098 60 0		269
C 25-B+C 1		5542957	5095 60 6		179	FLD 60		5578406	5098 63 8		270
C 25-B+C 1		5542957	5095 60 6		195						
CNS 3-D-D	ENBlack	5952817	5092 70 1		211	FRD 110		5578338	5098 55 7		267
						FRD 12		5578291	5098 50 6		266
						FRD 2-24		5578420	5098 72 7		268
CNS-D-D	ENLight grey	5314837	5092 60 4		211	FRD 24		5578307	5098 51 4		266
						FRD 24 HF		5578352	5098 57 5		265
DLS-BS		5685333	5082 38 2		251	FRD 2-5		5578437	5098 79 4		268
						FRD 48		5578314	5098 52 2		266
DS-7 16 M/W		5030881	5093 17 1		247	FRD 5		5578284	5098 49 2		266
						FRD 5 HF		5578345	5098 57 1		265
DS-BNC M/M		5391098	5093 26 0		246						
DS-BNC M/W		5391036	5093 25 2		245	FS-V20		5397458	5099 80 3		289
DS-BNC W/W		5390978	5093 23 6		245						
DS-F M/W		5022732	5093 27 5		247	ISAV1000R	/ GFK	5004608	5408 84 9		386
DS-F W/W		5022619	5093 27 2		247	ISAV1000W	/ GFK	5009733	5408 85 2		386
DS-N M/W		5805991	5093 99 6		246					/100 m	
DS-N W/W		5962243	5093 98 8		246	isCon 750 LGR	Light grey	5888123	5407 99 5		388
						isCon 750 LGR	Light grey	5888154	5407 99 7		388
DS-SMA W/W		5867050	5093 27 7		247	isCon 750 SW	Black	5674573	5408 00 2		388
						isCon 750 SW	Black	5674627	5408 00 4		388
DS-TNC M/W		5087250	5093 27 0		246	isCon 750 SW	Black	5854265	5408 00 6		388
FC-D	ENPure white	5035053	5092 80 0		210	isCon AP1-16 VA	/ V2A	5674696	5408 02 6	/pc.	392
						isCon AP2-16 VA	/ V2A	5674702	5408 02 8		392
FC-ISDN-D	ENPure white	5047223	5092 81 2		211	isCon connect	/ V2A	5674689	5408 02 2		388
						isCon cut		5674641	5408 01 1		388
FC-RJD	ENPure white	5047254	5092 82 8		211	isCon DH	23-26 / GFK	5674863	5408 04 3		390
FC-SAT-D	ENPure white	5035176	5092 81 6		210	isCon EPPA 004	140200/ Z-PP-P	5813781	5408 06 0	/100 pc.	
FC-TAE-D	ENPure white	5035237	5092 82 4		210	isCon H 26 VA	/ V2A	5872696	5408 06 4	/pc.	389
FC-TV-D	ENPure white	5035114	5092 80 8		210	isCon H VA	/ V2A	5699668	5408 05 6		389
						isCon H280 26 PA	Light grey/ PA	5872757	5408 07 2		390
FDB-2 24-M	3222	5683339	5098 38 0		282	isCon H280 26 VA	/ V2A	5872764	5408 07 4		390
FDB-2 24-N	3222	5683384	5098 39 0		282	isCon H280 PA	Black/ PA	5674887	5408 04 9		390
FDB-3 24-M	3222	5683346	5098 38 2		282	isCon H280 VA	/ V2A	5674870	5408 04 7		390
FDB-3 24-N	3222	5683391	5098 39 2		282	isCon HS 26 PA	Light grey/ PA	5872702	5408 06 6		389
						isCon HS 26 VA	/ V2A	5872740	5408 06 8		389
						isCon HS PA	Black/ PA	5674917	5408 05 4		389
						isCon HS VA	/ V2A	5674726	5408 05 2		389
F-FIX-10		5070054	5403 10 3	/100 pc.	333	isCon HWS	/ PS	5813774	5408 05 8		
F-FIX-10B		5070061	5403 11 0		333	isCon IN connect	M16/ V2A	5864172	5408 02 4		391
F-FIX-132	110/ V2A	5613572	5403 33 0	/pc.	336	isCon IN PAE	49,9/ AI	5871569	5408 03 1		391
F-Fix-132-300	300/ V2A	5813903	5403 33 3		336	isCon PAE	/ V2A	5674719	5408 03 6		388
						isCon stripper	23-26	5674634	5408 00 9		388
F-FIX-16		5548713	5403 20 0	/100 pc.	333	isFang 3B-100	1000/ V2A	5670148	5408 96 8		337
F-FIX-16B		5110637	5403 20 5		333	isFang 3B-100	1000/ V2A	5670148	5408 96 8		391
F-FIX-B10	/ PP	5070085	5403 12 4		334	isFang 3B-100 AL	1000/ AI	5802433	5408 96 6		337
F-FIX-B10	/ PP	5070085	5403 12 4		385	isFang 3B-100 AL	1000/ AI	5802433	5408 96 6		391
F-FIX-B16	/ PP	5548959	5403 23 5		333	isFang 3B-100-A	1026/ V2A	5859550	5408 93 0		337
F-FIX-B16	/ PP	5548959	5403 23 5		384	isFang 3B-100-A	1026/ V2A	5859550	5408 93 0		391
F-FIX-B16 3B	25/ PP	5926320	5403 23 8		338	isFang 3B-150	1500/ V2A	5674931	5408 96 9		337
F-FIX-B16 3B	25/ PP	5926320	5403 23 8		392	isFang 3B-150	1500/ V2A	5674931	5408 96 9		391
						isFang 3B-150 AL	1500/ AI	5802440	5408 96 7		337
F-FIX-BASIS	/ PP	5034933	5403 32 4	/pc.	332	isFang 3B-150 AL	1500/ AI	5802440	5408 96 7		391
F-FIX-JUNIOR	1000/ AI	5034872	5403 30 8		332	isFang 3B-150-A	1500/ V2A	5859567	5408 93 2		337
						isFang 3B-150-A	1500/ V2A	5859567	5408 93 2		391
F-FIX-KL	/ V2A	5548775	5403 21 9		334	isFang 3B-G1	270/ V2A	5674948	5408 97 1		338
F-FIX-S10		5070078	5403 11 7		334	isFang 3B-G1	270/ V2A	5674948	5408 97 1		392
F-FIX-S10		5070078	5403 11 7		384	isFang 3B-G2	340/ V2A	5674979	5408 97 2		338
F-FIX-S16		5548898	5403 22 7		333	isFang 3B-G2	340/ V2A	5674979	5408 97 2		392
F-FIX-S16		5548898	5403 22 7		338	isFang 3B-G3	430/ V2A	5674986	5408 97 3		338
F-FIX-S16		5548898	5403 22 7		384	isFang 3B-G3	430/ V2A	5674986	5408 97 3		392
F-FIX-S16		5548898	5403 22 7		392	isFang 4000	1240/ GFK	5670056	5408 94 2		337
						isFang 4000	1240/ GFK	5670056	5408 94 2		391

02\_TBS\_Masterkatalog\_Länder\_2012 / en / 10/04/2012 (LLExpert\_01433)

# Type listing

Structure of the GTIN: Country code **40**      Manufacturer code **1219**      Individual GTIN **5647589**

Type	Dimensions/Colour/Div.	GTIN	Art. no.	Price	Page	Type	Dimensions/Colour/Div.	GTIN	Art. no.	Price	Page
				/pc.						/pc.	
isFang 4000 AL	1240/ GFK	5785330	5408 94 3		337	MB 1		5415732	5096 64 8		205
isFang 4000 AL	1240/ GFK	5785330	5408 94 3		391	MB 1+FS		5415749	5096 64 9		165
isFang 6000	3340/ GFK	5670063	5408 94 6		337	MB 1+FS		5415749	5096 64 9		196
isFang 6000	3340/ GFK	5670063	5408 94 6		391	MB 1+FS		5415749	5096 64 9		205
isFang 6000 AL	3340/ GFK	5785347	5408 94 7		337	MB 1+NPE		5415770	5096 65 0		165
isFang 6000 AL	3340/ GFK	5785347	5408 94 7		391	MB 1+NPE		5415770	5096 65 0		196
isFang IN 4000	1325/ GFK	5871613	5408 93 4		338	MB 1+NPE		5415770	5096 65 0		205
isFang IN 4000	1325/ GFK	5871613	5408 93 4		393	MB 1+NPE+FS		5415787	5096 65 1		165
isFang IN 6000	3325/ GFK	5871620	5408 93 6		338	MB 1+NPE+FS		5415787	5096 65 1		196
isFang IN 6000	3325/ GFK	5871620	5408 93 6		393	MB 1+NPE+FS		5415787	5096 65 1		205
isFang IN-A 4000	1325/ GFK	5871668	5408 93 8		337						
isFang IN-A 4000	1325/ GFK	5871668	5408 93 8		390	MB 2		5415794	5096 65 3		165
isFang IN-A 6000	3325/ GFK	5871675	5408 94 0		337	MB 2		5415794	5096 65 3		196
isFang IN-A 6000	3325/ GFK	5871675	5408 94 0		390	MB 2		5415794	5096 65 3		205
isFang TR100	40/ V2A	5670100	5408 95 6		339	MB 2+FS		5415800	5096 65 4		165
isFang TR100	40/ V2A	5670100	5408 95 6		393	MB 2+FS		5415800	5096 65 4		196
isFang TR100 100	100/ V2A	5849360	5408 95 5		339	MB 2+FS		5415800	5096 65 4		205
isFang TR100 100	100/ V2A	5849360	5408 95 5		394	MB 2+NPE		5067481	5096 65 5		165
isFang TR100 200	200/ V2A	5849391	5408 95 7		339	MB 2+NPE		5067481	5096 65 5		196
isFang TR100 200	200/ V2A	5849391	5408 95 7		394	MB 2+NPE		5067481	5096 65 5		205
isFang TR100 300	300/ V2A	5849407	5408 95 9		339	MB 2+NPE+FS		5067498	5096 65 7		165
isFang TR100 300	300/ V2A	5849407	5408 95 9		394	MB 2+NPE+FS		5067498	5096 65 7		196
isFang TS40-50	40/ V2A	5670117	5408 95 8		339	MB 2+NPE+FS		5067498	5096 65 7		205
isFang TS40-50	40/ V2A	5670117	5408 95 8		394						
isFang TS50-60	30/ V2A	5670124	5408 96 0			MB 3		5067504	5096 66 5		165
isFang TS50-60	30/ V2A	5670124	5408 96 0		339	MB 3		5067504	5096 66 5		196
isFang TS50x50	30/ V2A	5670131	5408 96 4			MB 3		5067504	5096 66 5		205
isFang TS50x50	30/ V2A	5670131	5408 96 4		339	MB 3+FS		5067535	5096 66 7		165
isFang TW200	300/ V2A	5670094	5408 95 4		338	MB 3+FS		5067535	5096 66 7		196
isFang TW200	300/ V2A	5670094	5408 95 4		393	MB 3+FS		5067535	5096 66 7		205
isFang TW30	30/ V2A	5670087	5408 95 2		338	MB 3+NPE		5067542	5096 66 9		165
isFang TW30	30/ V2A	5670087	5408 95 2		393	MB 3+NPE		5067542	5096 66 9		196
isFang TW80	80/ V2A	5670070	5408 95 0		338	MB 3+NPE		5067542	5096 66 9		205
isFang TW80	80/ V2A	5670070	5408 95 0		393	MB 3+NPE+FS		5067559	5096 67 1		165
						MB 3+NPE+FS		5067559	5096 67 1		196
ISO-A-1030	1080/ AI	5770497	5408 82 0		387	MB 3+NPE+FS		5067559	5096 67 1		205
ISO-A-500	500/ AI	5542773	5408 80 6		387						
ISO-A-800	800/ AI	5542834	5408 81 4		387	MB 4		5067566	5096 68 0		165
						MB 4		5067566	5096 68 0		196
						MB 4		5067566	5096 68 0		205
ISOLAB	D/GB	5921738	5096 81 2		292	MB 4+FS		5067597	5096 68 2		165
KB MB		5709350	5089 66 0		206	MB 4+FS		5067597	5096 68 2		196
KB MB		5709367	5089 66 2		206						
						MB 50-3+NPE		5425144	5096 67 5		152
KOAX B-E2 MF-C		5684916	5082 41 2		250	MB 50-3+NPE+FS		5425151	5096 67 7		152
KOAX B-E2 MF-F		5684855	5082 42 0		250						
						MB25-3+NPE		5871200	5096 67 2		191
KoaxB-E2 FF-F		5685074	5082 42 2		251	MB25-3+NPE+FS		5871248	5096 67 3		191
LC 63		5509899	5096 97 0		143	MB-FS		5813484	5096 69 3		
						MB-FS		5813484	5096 69 3		164
						MB-FS		5813484	5096 69 3		197
LE ERDER FT	1000/ St / FT	5018001	5000 29 7		312						
LE ERDER FT	1500/ St / FT	5617358	5000 30 0		312	MB-SG	Blue/ PA	5616375	5096 69 5		
LE ERDER V4A	1500/ V4A	5708834	5000 33 5		312	MB-SG	Blue/ PA	5616375	5096 69 5		164
						MB-SG	Blue/ PA	5616375	5096 69 5		206
LE HAMMER-AC	/ St	5111641	3043 61 8		315	MC 125-B NPE		5966449	5096 86 3		140
LE HAMMER-B	/ St	5087137	3043 61 4		315						
LE HAMMER-B-II	/ St	5421627	3043 62 8		315	MC 50-B 0 VDE		5480730	5096 82 0		142
LE HAMMER-H	/ St	5087076	3043 61 0		315	MC 50-B 0-OS		5051428	5096 82 5		142
LE HAMMER-SDS-M	/ St	5111160	3043 60 2		315	MC 50-B 3		5077046	5096 87 6		141
LE HAMMER-W	/ St	5617419	3043 60 6		315	MC 50-B 3+1		5077084	5096 87 8		140
						MC 50-B U VDE		5480792	5096 83 9		143
						MC 50-B VDE		5966388	5096 84 7		141
LE KOPF	/ St / FT	5617297	3042 30 8		313	MC 50-B-OS		5051411	5096 85 1		141
LE SPITZE	/ St / FT	5617235	3041 40 9		313	MC V3	/ Cu	5531135	5096 88 4		143
						MC V4	/ Cu	5531197	5096 88 6		143
LFC		5425182	5096 78 6		292	MCD 125-B NPE		5541394	5096 86 5		136
						MCD 50-B		5541158	5096 84 9		137
LSA-A-LEI	Grey	5525134	5084 00 8		241	MCD 50-B 0		5544517	5096 82 2		142
LSA-BF-180		5525370	5084 02 4		242	MCD 50-B 0-OS		5051473	5096 82 7		142
LSA-BF-24		5525431	5084 02 8		242	MCD 50-B 3		5077077	5096 87 7		137
LSA-B-MAG		5525318	5084 02 0		241	MCD 50-B 3+1		5077091	5096 87 9		136
LSA-E		5525493	5084 03 2		242	MCD 50-B 3+1-OS		5288299	5096 83 6		136
LSA-E-LEI	Red	5525257	5084 01 6		241	MCD 50-B 3+1-VG		5362036	5096 87 5		138
LSA-G	Light grey/ PA	5110750	5084 04 8		243	MCD 50-B 3-OS		5288282	5096 83 5		137
LSA-M	/ St	5525554	5084 03 6		242	MCD 50-B 3-VG		5362029	5096 87 4		139
LSA-T-LEI	White	5525196	5084 01 2		241	MCD 50-B-OS		5051466	5096 85 2		137
LSA-TOOL		5525615	5084 04 0		243						
						MDP-2 D-12-T-10		5787372	5098 41 5		278
MB 1		5415732	5096 64 8		165	MDP-2 D-24-T		5406860	5098 42 2		275
MB 1		5415732	5096 64 8		196	MDP-2 D-24-T-10		5787389	5098 42 5		279

Type	Dimensions/Colour/Div.	GTIN	Art. no.	Price	Page	Type	Dimensions/Colour/Div.	GTIN	Art. no.	Price	Page
MDP-2 D-48-T		5406891	5098 44 2	/pc.	276	RD 8-FT	/ St / FT	5381556	5021 08 1	/100 m	330
MDP-2 D-5-T		5406839	5098 40 4		274	RD 8-PVC	Cream8/ Al	5067474	5021 33 2		311
MDP-3 D-24-T		5406877	5098 42 7		275	RD 8-PVC	Cream8/ Al	5067474	5021 33 2		331
MDP-3 D-48-T		5406907	5098 44 6		276	RD 8-V2A	/ V2A	5680529	5021 23 5		311
MDP-3 D-5-T		5406846	5098 40 7		274	RD 8-V2A	/ V2A	5680529	5021 23 5		331
MDP-4 D-12-T-10		5773610	5098 41 9		278	RD 8-V4A	/ V4A	5680574	5021 64 4		311
MDP-4 D-24-EX		5848523	5098 43 2		284	RD 8-V4A	/ V4A	5680574	5021 64 4		331
MDP-4 D-24-T		5406884	5098 43 1		275						
MDP-4 D-24-T-10		5625131	5098 43 3		279						
MDP-4 D-48-EX		5848530	5098 45 2		284						
MDP-4 D-48-T		5406914	5098 45 0		276	RJ11-TELE 4-C		5680536	5081 92 0	/pc.	237
MDP-4 D-5-EX		5848516	5098 41 2		284	RJ11-TELE 4-C		5680536	5081 92 0		238
MDP-4 D-5-T		5406853	5098 41 1		274	RJ11-TELE 4-F		5680413	5081 93 9		238
MDP-4 D-5-T-10		5625124	5098 41 3		277						
				/VPE		RJ45 S-ATM 8-F		5462439	5081 79 3		250
						RJ45 S-E100 4-B		5239956	5081 72 6		252
MK-B		5461111	5091 32 2		293	RJ45 S-E100 4-C		5239895	5081 73 4		252
MK-B		5461111	5091 32 2		376	RJ45 S-E100 4-F		5239833	5081 74 2		252
						RJ45-ISDN 4-C-G		5889458	5081 54 8		239
						RJ45S-V24T 4-F		5502630	5081 64 5		253
				/100 pc.		RJ45S-V24T 8-F		5502692	5081 64 7		253
M-Quick M25 SW	Jet black 20-25 / PA	5505396	2153 78 7		390	RJ45-TELE 4-C		5791119	5081 96 3		238
M-Quick M32 LGR	Light grey 25-32 / PA	5741671	2153 73 4		390	RJ45-TELE 4-F		5791058	5081 97 1		238
				/pc.						/100 pc.	
ND-CAT6A/EA		5614364	5081 80 0		250	RK-FIX	/ St / FT	5433682	5316 45 0		365
				/VPE		RK-FIX CU	/ V2A / Cu	5433736	5316 46 8		365
						RK-FIX VA	/ V2A	5433729	5316 45 9		365
PCS		5461296	5091 43 8		293					/100 m	
PCS		5461296	5091 43 8		376						
				/pc.		S 11-CU	10,5/ Cu	5836209	5021 65 4		
PCS-CS-D	EN	5461654	5091 68 3		293	S 11-CU	10,5/ Cu	5836209	5021 65 4		
PCS-CS-D	EN	5461654	5091 68 3		377						
PCS-CS-GB	GB	5896111	5091 69 1		293	S 9-CU	9/ Cu	5382218	5021 65 0		
PCS-CS-GB	GB	5896111	5091 69 1		377	S 9-CU	9/ Cu	5382218	5021 65 0		
				/VPE							
PCSH		5461470	5091 52 7		293					/pc.	
PCSH		5461470	5091 52 7		377						
				/pc.		SC-TELE 4-C-G		5834793	5081 68 8		237
PS 2-B+C/TT+TNS		5759782	5089 74 8		167	SD09-V11 9		5916277	5080 06 1		256
						SD09-V24 9		5915973	5080 05 3		255
PS3-B+C TNC		5405528	5089 75 4		168						
PS3-B+C TNC+FS		5405535	5089 75 6		168	SD15-V24 15		5916031	5080 15 0		255
PS3-B+C-320		5806813	5089 75 5		168						
PS3-B+C-320+FS		5816614	5089 75 7		168	SD25-V11 25		5916390	5080 28 2		256
PS3-VA TNC		5405566	5089 76 8		170	SD25-V24 25		5916215	5080 27 4		255
PS3-VA TNC+FS		5405580	5089 77 5		170						
PS4-B+C TNS+FS		5405559	5089 76 3		167	SD-Fix	/ V2A	5670735	5403 33 5		335
PS4-B+C TT+TNS		5405542	5089 76 1		167						
PS4-VA TT+FS		5405597	5089 77 7		169						
PS4-VA TT+TNS		5405573	5089 77 0		169						
				/100 pc.		SQ M6	Light grey M6/ PC	5016069	2146 50 9		389
P-TK		5017387	5086 01 9		207						
P-TK+SAT		5017448	5086 02 3		207	SQ PP	630/ PA	5016182	2351 70 6		389
P-TK+TV		5017509	5086 02 7		207						
				/100 m		SQ-20 SW	Jet black 23/ PP	5655367	2146 16 4		389
						SQ-25 LGR	Light grey 26/ PA	5595717	2146 20 7		389
RD 10	/ St / FT	5381617	5021 10 3		310					/pc.	
RD 10	/ St / FT	5381617	5021 10 3		330						
RD 10-ALU	/ Al	5381976	5021 30 8		311	S-UHF M/W		5390732	5093 02 3		245
RD 10-ALU	/ Al	5381976	5021 30 8		331	S-UHF W/W		5390671	5093 01 5		245
RD 10-CU	/ Cu	5382096	5021 50 2		311						
RD 10-CU	/ Cu	5382096	5021 50 2		331	TKS-B		5578277	5097 97 6		265
RD 10-PVC	Black 10/ st / FT	5381730	5021 16 2		310						
RD 10-PVC	Black 10/ st / FT	5381730	5021 16 2		330						
RD 10-V2A	/ V2A	5801375	5021 22 7		311					/100 pc.	
RD 10-V2A	/ V2A	5801375	5021 22 7		331	TrayFix		5738428	5403 10 0		334
RD 10-V2A	/ V2A	5680567	5021 23 9		311	TrayFix		5738428	5403 10 0		377
RD 10-V2A	/ V2A	5680567	5021 23 9		331						
RD 10-V4A	/ V4A	5902058	5021 64 2		311						
RD 10-V4A	/ V4A	5902058	5021 64 2		331						
RD 10-V4A	/ V4A	5680581	5021 64 7		311	TV 4+1		5022978	5083 40 0	/pc.	248
RD 10-V4A	/ V4A	5680581	5021 64 7		331						
RD 8-ALU	/ Al	5381914	5021 28 6		311	ÜSM-A		5080886	5092 45 1		212
RD 8-ALU	/ Al	5381914	5021 28 6		331	ÜSM-A-150		5475804	5092 46 6		212
RD 8-ALU-T	/ Al	5901273	5021 29 4		311	ÜSM-A-2		5247098	5092 46 0		212
RD 8-ALU-T	/ Al	5901273	5021 29 4		331	ÜSM-A-4		5613596	5092 47 2		212
RD 8-CU	/ Cu	5382034	5021 48 0		311	ÜSM-A-TW		5613589	5092 47 0		212
RD 8-CU	/ Cu	5382034	5021 48 0		331						
RD 8-FT	/ St / FT	5381556	5021 08 1		310	ÜSS 45-A-ALU	Aluminium painted	5006220	6117 46 7		213

# Type listing

Structure of the GTIN: Country code **40** Manufacturer code **1219** Individual GTIN **5647589**

Type	Dimensions/Colour/Div.	GTIN	Art. no.	Price	Page	Type	Dimensions/Colour/Div.	GTIN	Art. no.	Price	Page
				/pc.						/pc.	
ÜSS 45-A-RW	Pure white	6117611	6117 46 5		213	V20-C U-2 AS		5393856	5096 41 3		206
ÜSS 45-O-ALU	Aluminium painted	5006213	6117 47 5		213	V20-C U-2 PH		5464457	5096 63 7		232
ÜSS 45-O-RW	Pure white	6117673	6117 47 3		213	V20-C U-2 PH+FS		5464464	5096 63 9		232
						V20-C U-3 AS		5393917	5096 42 1		166
						V20-C U-3 AS		5393917	5096 42 1		197
V 20-C 3+NPE+FS		5616382	5094 76 4		177	V20-C U-3 AS		5393917	5096 42 1		206
						V20-C U-3 FS-SÜ		5393559	5096 35 9		165
V 50-B+C 0-150	200	5681939	5094 40 0		151	V20-C U-3 FS-SÜ		5393559	5096 35 9		196
						V20-C U-3 FS-SÜ		5393559	5096 35 9		205
V10 COMPACT 150		5246268	5093 37 8		200	V20-C U-3+NPE		5063407	5096 37 0		166
V10 COMPACT 255		5076551	5093 38 0		200	V20-C U-3+NPE		5063407	5096 37 0		197
V10 COMPACT 385		5126041	5093 38 4		200	V20-C U-3+NPE		5063407	5096 37 0		206
V10 COMPACT-AS		5299448	5093 39 1		200	V20-C U-3+NPE-AS		5247104	5096 37 2		166
						V20-C U-3+NPE-AS		5247104	5096 37 2		197
V10-C 0-150		5158103	5093 40 0		204	V20-C U-3+NPE-AS		5247104	5096 37 2		206
V10-C 0-280		5012825	5093 40 2		204	V20-C U-3PH-Y		5299455	5096 64 7		232
V10-C 0-320		5012832	5093 40 4		204	V20-C U-3PH-Y-FS		5648499	5096 64 6		232
V10-C 0-385		5004660	5093 40 6		204	V20-C U-4 AS		5393979	5096 44 8		166
V10-C 1+NPE-280		5382799	5093 41 8		202	V20-C U-4 AS		5393979	5096 44 8		197
V10-C 3+NPE		5363903	5094 92 0		202	V20-C U-4 AS		5393979	5096 44 8		206
V10-C 3+NPE+FS		5363941	5094 93 1		202	V20-C U-4 FS-SÜ		5393610	5096 36 7		165
V10-C 3+NPE-320		5363934	5094 92 4		203	V20-C U-4 FS-SÜ		5393610	5096 36 7		196
						V20-C U-4 FS-SÜ		5393610	5096 36 7		205
V20-C 0-150	200	5519133	5096 70 7		193	V20-C3+NPE400+FS		5871262	5094 90 2		191
V20-C 0-280	350	5396918	5099 60 9		193	V20-VA 0		5807612	5099 61 3		195
V20-C 0-300PV	300	5708902	5099 61 1		231	V20-VA 1-385		5406716	5099 47 5		192
V20-C 0-320-SP	420	5570318	5099 84 8		193						
V20-C 0-335	420	5481270	5099 85 0		194	V25-B+C 0-150	200	5965664	5097 08 8		163
V20-C 0-385	505	5396857	5099 59 5		194	V25-B+C 0-280	350	5394099	5097 05 3		163
V20-C 0-440	585	5942498	5099 70 6		194	V25-B+C 0-320	420	5711551	5097 29 0		163
V20-C 0-500PV	500	5708933	5099 70 8		231	V25-B+C 0-385	505	5766636	5097 06 1		163
V20-C 0-550	745	5396970	5099 61 7		194	V25-B+C 0-450PV	450	5708896	5097 06 5		231
V20-C 0-75	100	5396734	5099 57 9		193	V25-B+C 1+NPE		5382850	5094 45 7		156
V20-C 1+FS-280		5406679	5094 72 7		182	V25-B+C 1+NPE+FS		5374886	5094 44 4		157
V20-C 1+NPE+FS		5382911	5094 76 0		180	V25-B+C 1-150		5457473	5094 40 1		155
V20-C 1+NPE-150		5382966	5094 63 9		176	V25-B+C 1-280		5406556	5094 41 8		158
V20-C 1+NPE-280		5382973	5094 65 0		179	V25-B+C 1-385		5406563	5094 43 1		162
V20-C 1+NPE-385		5382980	5094 66 6		185	V25-B+C 1NPE150		5382843	5094 44 8		154
V20-C 1-150		5406617	5094 67 7		178	V25-B+C 2+NPE		5239826	5094 46 0		156
V20-C 1-280		5406594	5094 61 8		181	V25-B+C 2-150		5382812	5094 40 3		155
V20-C 1-385		5406655	5094 70 3		186	V25-B+C 2-280		5382829	5094 42 1		158
V20-C 1-550		5406662	5094 71 3		188	V25-B+C 2-385		5382836	5094 43 4		162
V20-C 2+AS-280		5393672	5096 37 5		183	V25-B+C 2-PH900	900	5478690	5097 45 7		221
V20-C 2+FS-280		5374923	5094 63 2		182	V25-B+C 2PHFS900	900	5709138	5097 45 8		221
V20-C 2+FS-550		5374985	5094 63 6		189	V25-B+C 3+AS		5945314	5097 18 5		159
V20-C 2+NPE+FS		5240235	5094 76 2		180	V25-B+C 3+NPE		5239864	5094 46 3		156
V20-C 2+NPE-150		5240044	5094 64 1		176	V25-B+C 3+NPE+AS		5617532	5097 43 2		157
V20-C 2+NPE-280		5240068	5094 65 3		179	V25-B+C 3+NPE-FS		5239949	5094 51 0		157
V20-C 2+NPEFS15		5240228	5094 75 0		177	V25-B+C 3-280		5239734	5094 42 3		158
V20-C 2-150		5382881	5094 67 9		178	V25-B+C 3-385		5239758	5094 43 7		162
V20-C 2-280		5382867	5094 62 1		181	V25-B+C 3-FS280		5239925	5094 49 0		159
V20-C 2-385		5382898	5094 70 4		186	V25-B+C 3NPE150		5239819	5094 45 4		154
V20-C 2-550		5382904	5094 71 4		188	V25-B+C 3NPE385		5239888	5094 47 8		161
V20-C 2-PH-1000	1000	5478669	5094 61 7		223	V25-B+C 3NPEAS38		5542056	5097 11 1		161
V20-C 2PH-600	600	5708889	5094 61 3		222	V25-B+C 3NPEFS38		5239994	5094 52 6		161
V20-C 2PHFS-1000	1000	5709114	5094 61 5		223	V25-B+C 3-PH900	900	5478683	5097 44 7		221
V20-C 2PHFS-600	600	5709077	5094 57 2		222	V25-B+C 3PHFS900	900	5709121	5097 44 8		221
V20-C 3+AS-280		5393733	5096 38 3		183	V25-B+C 4+AS280		5394211	5097 19 3		159
V20-C 3+FS-280		5240198	5094 73 1		182	V25-B+C 4+FS-SÜ		5394396	5097 35 5		160
V20-C 3+FS-385		5240280	5094 78 0		187	V25-B+C 4-280		5239741	5094 42 6		158
V20-C 3+FS-550		5240334	5094 79 2		189	V25-B+C 4-385		5239765	5094 44 0		162
V20-C 3+FS-SÜ		5393191	5096 25 1		184	V25-B+C 4-FS280		5239932	5094 49 3		159
V20-C 3+NPE+AS		5617471	5096 39 7		180	V25-B+C 4-FS-G		5240013	5094 55 2		160
V20-C 3+NPE+FS		5240242	5094 76 5		180						
V20-C 3+NPE-150		5240051	5094 64 4		176	V50-B+C 0-280	350	5361954	5093 72 4		151
V20-C 3+NPE-280		5240099	5094 65 6		179	V50-B+C 0-300PV	300	5708841	5093 72 6		231
V20-C 3+NPE-385		5240112	5094 66 8		185	V50-B+C 1+NPE		5688426	5093 65 3		148
V20-C 3+NPE400		5871255	5094 90 0		191	V50-B+C 1+NPE+FS		5688433	5093 66 1		149
V20-C 3+NPEFS38		5240303	5094 78 8		185	V50-B+C 2+NPE		5836797	5093 65 5		148
V20-C 3-150		5240129	5094 68 0		178	V50-B+C 2-PH600	600	5478553	5093 62 8		220
V20-C 3-280		5240020	5094 62 4		181	V50-B+C 2PHFS600	600	5709060	5093 62 9		220
V20-C 3-385		5240150	5094 70 5		186	V50-B+C 3+FS280		5361916	5093 64 3		150
V20-C 3-550		5240174	5094 71 5		188	V50-B+C 3+NPE		5425120	5093 65 4		148
V20-C 3-PH-1000	1000	5478621	5094 60 8		223	V50-B+C 3+NPE+FS		5425137	5093 66 2		149
V20-C 3PH-600	600	5708872	5094 60 5		222	V50-B+C 3-280		5361893	5093 62 7		150
V20-C 3PHFS-1000	1000	5648482	5094 57 4		223	V50-B+C 3-PH600	600	5478546	5093 62 3		220
V20-C 3PHFS-600	600	5709084	5094 57 6		222	V50-B+C 3PHFS600	600	5709022	5093 62 5		220
V20-C 4+AS-280		5393795	5096 39 1		183	V50-B+C 4		5361909	5093 63 1		150
V20-C 4+FS-280		5240204	5094 73 4		182	V50-B+C 4+FS		5361923	5093 64 7		150
V20-C 4+FS-550		5240341	5094 79 5		189						
V20-C 4+FS-SÜ		5393252	5096 27 8		184	VB-MDP 10-MD	/ Cu	5410461	5098 47 0		280
V20-C 4-280		5240037	5094 62 7		181	VB-MULTIBASE250		5237358	5089 65 5		164
V20-C 4-385		5240167	5094 70 8		186						
V20-C 4-550		5240181	5094 71 8		188	VB-V10 COMPACT-2		5237341	5089 65 0		201
V20-C U-2 AS		5393856	5096 41 3		166	VB-V10 COMPACT-4		5299400	5089 65 2		201
V20-C U-2 AS		5393856	5096 41 3		197						

02\_TBS\_Masterkatalog\_Länder\_2012 / en / 10/04/2012 (LLEXP01433)



Type	Dimensions/Colour/Div.	GTIN	Art. no.	Price	Page
				/pc.	
VF110-AC DC	150	5578154	5097 63 1		215
VF110-AC DC	150	5578154	5097 63 1		260
VF110-AC DC-FS	200150	5578192	5097 84 6		216
VF110-AC DC-FS	200150	5578192	5097 84 6		262
VF12-AC DC	13,5	5578116	5097 45 3		214
VF12-AC DC	13,5	5578116	5097 45 3		259
VF12-AC/DC-FS	1813,5	5736561	5097 45 4		261
VF2-110-AC/DCFS	150200	5578253	5097 93 5		217
VF2-110-AC/DCFS	150200	5578253	5097 93 5		263
VF2-230-AC/DC-FS	255350	5578260	5097 93 9		217
VF2-230-AC/DC-FS	255350	5578260	5097 93 9		263
VF2-24-AC/DC-FS	3446	5578246	5097 93 1		217
VF2-24-AC/DC-FS	3446	5578246	5097 93 1		263
VF230-AC/DC	255	5578161	5097 65 0		215
VF230-AC/DC	255	5578161	5097 65 0		260
VF230-AC-FS	255	5578215	5097 85 8		216
VF230-AC-FS	255	5578215	5097 85 8		262
VF24-AC/DC	34	5578123	5097 60 7		214
VF24-AC/DC	34	5578123	5097 60 7		259
VF24-AC/DC-FS	4634	5578185	5097 82 0		216
VF24-AC/DC-FS	4634	5578185	5097 82 0		261
VF48-AC/DC	60	5578130	5097 61 5		214
VF48-AC/DC	60	5578130	5097 61 5		259
VF48-AC/DC-FS	8060	5812258	5097 82 2		261
VF60-AC/DC	80	5578147	5097 62 3		214
VF60-AC/DC	80	5578147	5097 62 3		259
VF60-AC/DC-FS	11080	5812265	5097 82 4		262
VF-FS		5813521	5098 47 5		280
VG 3-B TNC		5531074	5089 21 2		139
VG 4-B TNS+TT		5531012	5089 20 0		138
VG LM	/ PA	5047155	5088 87 9		164
VG-BC DC-MSFS600	600	5835646	5088 69 5		227
VG-BC DC-MSFS900	900	5835653	5088 69 6		227
VG-BC DCPH900-21	900	5872641	5088 62 5		224
VG-BC DCPH900-31	900	5872658	5088 62 9		224
VG-BC DCPH-MS600	600	5613725	5088 69 3		226
VG-BC DCPH-MS900	900	5613718	5088 69 2		226
VG-BC DCPH-Y600	600	5709008	5088 67 6		229
VG-BC DCPH-Y900	900	5709015	5088 67 8		229
VG-C DCPH1000-21	1000	5829461	5088 64 6		224
VG-C DCPH1000-31	1000	5829478	5088 64 8		224
VG-C DC-PH1000-4	1000	5704010	5088 70 3		228
VG-C DCPH1000-4K	1000	5780700	5088 65 0		226
VG-C DCPH1000-4S	1000	5780717	5088 65 1		225
VG-C DCPH1000-6S	1000	5780724	5088 65 2		225
VG-C DC-PH-21	1000	5890805	5088 60 5		230
VG-C DC-PH-31	1000	5890812	5088 60 9		230
VG-C DC-PH-MS	1000	5371090	5088 69 4		230
VG-C DCPH-MS1000	1000	5613701	5088 69 1		226
VG-C DC-PH-Y	1000	5473206	5088 69 9		230
VG-C DCPH-Y1000	1000	5708964	5088 67 2		229
VG-C DCPH-Y600	600	5708957	5088 67 0		229
ZSF		5518419	2362 97 0		377

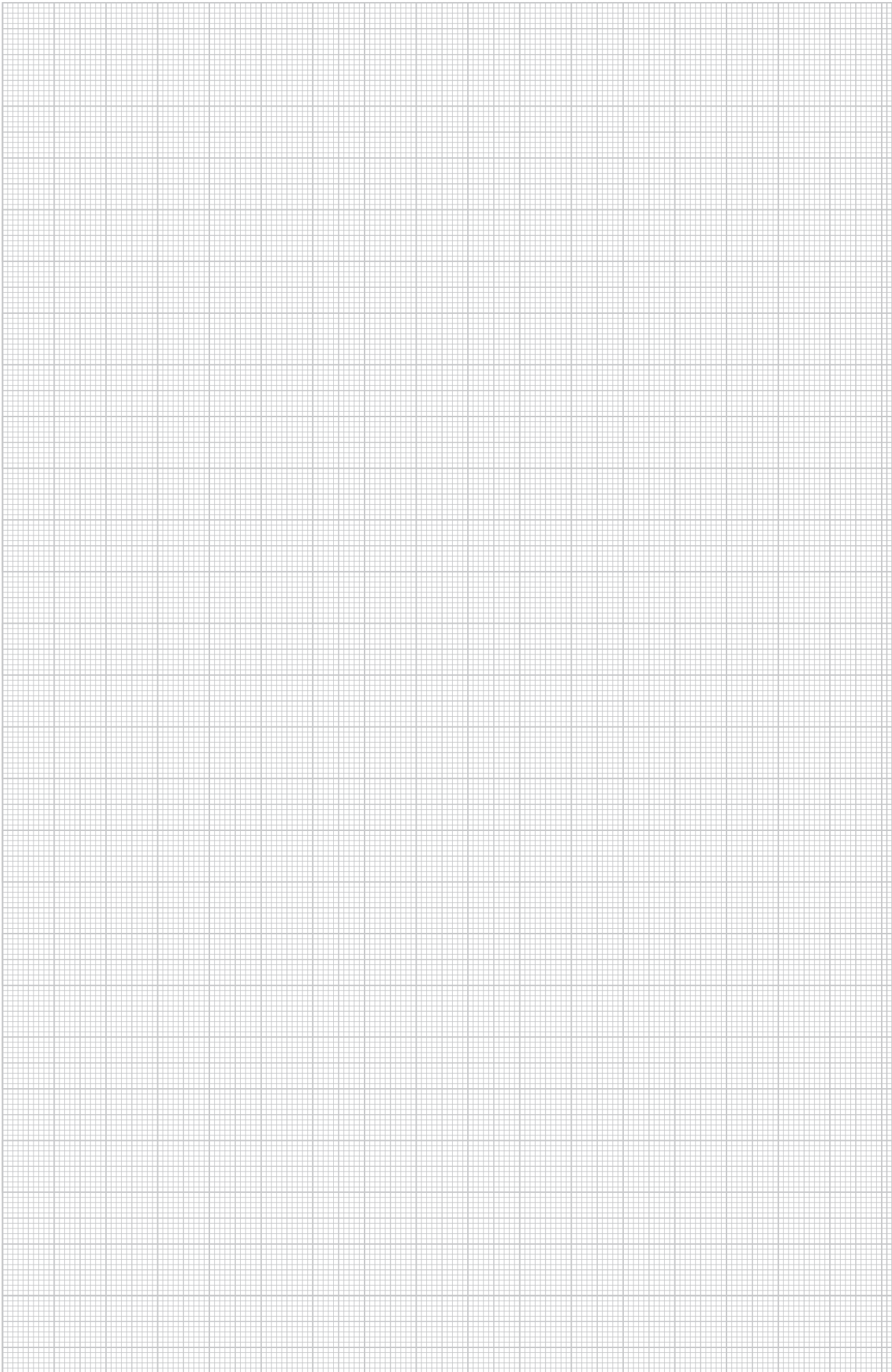

**Terms and conditions of sale and delivery**  
of OBO BETTERMANN GmbH & Co. KG, OBO BETTERMANN Projekt und Systemtechnik GmbH  
and OBO Befestigungselemente GmbH, Menden.

1. All our supplies and services shall be governed exclusively by the following terms and conditions, including our additional terms and conditions for cable tray business transactions. Any terms and conditions of business and purchasing of the customer shall be valid only if we have acknowledged them in writing. Our quotations are without engagement; they are mere invitations to submit contract offers. Any and all transactions and agreements, including those entered into by our employees and agents shall only be binding upon our written confirmation or invoicing. The foregoing provision shall also apply to any modifications of the agreed formal requirements.

2. The documents and data pertaining to the quotation, such as illustrations, brochures, drawings, dimensions, loading capacity values and weight details are approximate only, unless they are expressly stipulated to be binding.

Samples are non-binding samples for inspection. Any purchase according to sample will be subject to customary deviations and deviations resulting from normal production processes. The properties of the sample shall be no guaranteed quality of the purchase object unless expressly stated otherwise in the confirmation of order. Samples must be returned to us at the latest within four weeks in perfect condition. If they are not returned within this period in proper condition, we shall be entitled to charge the purchase price for the sample in accordance with our current price list. All information on our products, in particular the illustrations, drawings, weight, dimension and performance data included in our quotations and printed matter shall be regarded as approximate average values and shall not represent any quality guarantee.

With regard to products made according to customer drawings, samples and other instructions of the customer, we will not provide any warranty nor assume any liability for the due and proper functioning of the product or for any other defects if and to the extent they are based upon the customer's specifications. The customer shall indemnify us from any third party claims, including claims for product liability as may be asserted against us for damages resulting from the products unless we have caused such damages by intent or gross negligence. The customer shall warrant that the manufacture and supply of products made in accordance with his instructions will not infringe any proprietary rights of third parties. Should any proprietary rights be asserted against us, we shall be entitled, without any legal review of the third party claims, to withdraw from the contract after hearing the customer, unless the third party withdraws the claims asserted against us under its proprietary rights within eight days by written declaration. The customer shall compensate us for any damage sustained as a result of the assertion of proprietary rights. In case of withdrawal, the work we have carried out so far shall be remunerated. Further rights under the statutory provisions shall not be affected thereby.

Any moulds, tools and design data produced by us for the execution of the order shall be our exclusive property. Unless expressly agreed otherwise, the customer shall not have any claims thereto, even if he has contributed to the costs of producing any such moulds, tools and design data.

3. The packing, shipping route and means of transportation shall be left to our discretion in the absence of any other agreements. They shall be charged at their cost price. We will take back undamaged cases, when being returned carriage paid, at 2/3 of the amount invoiced. The one-way or pool pallets used for transport shall be either exchanged upon taking delivery or returned. The smallest packing units stocked and listed may not be broken up for rationalisation reasons. In case of orders for different quantities, the nearest packing unit will be supplied.

We reserve the right to deviate from the agreed delivery quantity, in particular in the case of custom-made products, to a customary extent or in conformity with national or international standards. In case of a demand for adhering to a precise quantity, an express reference is necessary and subject to confirmation.

Master and call orders shall oblige the customer to accept the total quantity on which the master/call order is based. Where no particular call orders are specified in the contract, the total quantity of the master call order must be called within twelve months. If the customer fails to adhere to call deadlines, we shall be entitled to deliver and charge the total quantity in full after four weeks from written notice with reference to the consequences of any failure to call. Our rights arising from any default of the customer shall not be affected thereby.

4. Unless otherwise agreed, our prices are quoted ex works and do not include packing and insurance. The value added tax at the rate applicable on the date of dispatch will be added to our prices. The purchaser shall ensure the correctness of his VAT identification number, which he must notify to us immediately without being asked. He shall undertake to inform both us and the competent domestic tax authority without delay of any change in his name, address and VAT identification number.

Delivery shall be franco domicile within Germany, i.e. carriage and packing prepaid, if the net order value is in excess of € 1,200. For small orders below € 100 (net excluding value added tax), we shall invoice a lower quantity surcharge of € 10 (net) per order. Upon transfer of our supplies and services to a carrier or forwarding agent, at the latest upon their leaving our warehouse or supply plant, the risk shall pass to the recipient, even in case of deliveries free place of destination.

5. Delivery periods and delivery deadlines shall be approximate only unless we have expressly stated in writing that they are binding. Delivery periods shall commence upon receipt of our confirmation of order, but not before clarification of all execution details, ex place of delivery. The customer shall only be entitled to withdraw from the contract after having granted a reasonable extension of time. We reserve the right to make partial deliveries. Claims for damages and reimbursement of expenses - for any reason whatsoever - shall be subject to the provisions set out in article 10.

In the event of any circumstances that are beyond our control within the scope of normal operating risks and obstruct or make impracticable any delivery, we shall be entitled to suspend delivery by the duration of such obstruction plus a reasonable start-up period or to withdraw from the contract for the part not yet fulfilled. The purchaser can demand a statement from us as to whether we wish to deliver within a reasonable period or withdraw. If we fail to make such a statement, the purchaser may withdraw. Our notice to the purchaser shall be deemed to be sufficient evidence that we have been prevented from delivering.

Delivery time is extended in case of such events as labour disputes, strikes and lockouts, orders from the authorities, difficulties with the procurement of materials, spoiled work or post-processing, shutdowns and staff shortage as well as shortage of means of transport, and general occurrence of unforeseen events beyond our scope of influence, by the length of duration of these events.

6. Payments shall be made upon receipt of invoice less a 3% cash discount for payment within 10 days or net after 30 days from date of invoice. Erection work and all paid labour work must be paid within 10 days without deduction of any cash discount. In case of non-cash payments, the date of the credit note will be deemed to be the date of receipt of payment. Payments received shall always be credited first against costs, then against interest and then against the earliest liability. Cheques and bills of exchange shall only be accepted as means of payment.

Any payment by bill of exchange shall be subject to a prior separate and written agreement, whereby all bill costs shall be borne by the customer and no discount can be granted. The customer shall have no right to refuse performance and no right of retention - for any legal reason whatsoever - unless we have acknowledged his claim beforehand in writing or his claim has the force of law.

The customer shall only be entitled to set off claims which have the force of law, are undisputed or acknowledged by us in writing.

7. We shall retain title to the goods supplied by us until all our claims arising from our business transactions with the customer have been satisfied - current account clause - and all bills of exchange or cheques submitted for payment by the customer have been honoured.

Any treatment or processing of goods subject to our retention of title (reserved goods) shall be carried out for us as the manufacturer in accordance with § 950 BGB (German Civil Code) without any obligation on our part. If our reserved goods are to be regarded as the main item or the main item is owned by the customer, full title to the new item shall pass to us when it is created. In other cases, we shall acquire a co-ownership interest in the new item in the proportion of the sales value of our reserved goods to the other goods used for the new item at the time of processing, intermingling, joining or mixing. The customer shall take custody of our ownership or co-ownership interest free of charge; it shall be treated as reserved goods.

Before transfer of title, our goods shall be neither pledged nor assigned as collateral without our prior consent. In addition, any third party rights or pledges shall be notified to us immediately and we shall be given all details and provided all documents necessary for intervention; otherwise the customer must bear our loss. In the latter case, our total claims against the customer shall also be immediately payable.

The customer shall be entitled to sell or to use our reserved goods in the ordinary course of business subject to the condition that the relevant claims are transferred in accordance with article 8 below. This right shall lapse upon the customer's failure to promptly meet his payment obligations towards us or in the event of any cheque or bill protests or his suspension of payments. In such cases, we shall be entitled to take back the goods provisionally at

the customer's expense and to sell them at our duly exercised discretion after a corresponding reminder has been sent to the customer. We will then pass the due amount to the customer's credit.

8. If our goods are sold before payment of our claim, the customer shall be obliged to retain our title against his purchaser until the goods have been paid for in full by the purchaser. The claim arising against the purchaser from such resale as well as any other ancillary rights or security interests of the customer resulting from the sale and any claims for compensation in case of damage to or destruction of our reserved property, including the relevant insurance sum shall hereby be assigned to us. We hereby accept this assignment. Where our co-ownership interest is sold, the relevant claims shall be assigned in the amount corresponding to the value of our interest.

The customer shall, at our request, inform us of his purchasers, notify them of the assignment made and provide us with any and all documents required to assert our rights.

As long as the customer meets his contractual obligations without delay, he shall be authorised to collect the claims assigned. He shall keep the amounts collected on our behalf separately and remit them to us immediately as soon and as far as our claims become due. The authorisation shall lapse in case of any cheque or bill protest of the customer or his definite suspension of payments. The customer shall bear the costs incurred for any action taken against third parties and shall advance them upon request.

If the security provided to us by the retention of title and the anticipatory assignment should exceed the claims to be secured by more than 20%, we shall, at the customer's request, release paid supplies of our choice. Upon payment of all our claims by the customer, assigned claims shall pass to the customer.

9. Any complaints for obvious defects regarding the quantity or quality of our supplies and services that are identifiable upon careful inspection shall without delay, but at the latest within the period of limitation of eight days from arrival of the goods at the address of the customer or the person appointed by him, be notified in writing to us, not to our representatives. Slight deviations in dimensions and designs within the scope of defined technical tolerances shall not give rise to any right of complaint. Any rejected goods may only be returned to us with our prior written authorisation.

In case of justified complaints within the prescribed period, we shall, at our option, take remedial action by way of subsequent performance, by rectifying the defect, supplying non-defective goods or providing a credit note for the lower value calculated.

We shall be entitled to refuse subsequent performance in accordance with the statutory provisions. If we refuse subsequent performance, if any subsequent performance remains unsuccessful or if the customer cannot be reasonably expected to accept any subsequent performance, the latter shall be entitled to withdraw from the contract in compliance with the provisions of the following sentences. The customer shall only be entitled to withdraw from the contract - where a withdrawal is not excluded by law - upon the unsuccessful expiry of a reasonable period for subsequent performance set by him, unless this period was not required under the statutory provisions (§§ 281 para. 2, 323 para. 2, 440, 441 para. 1 BGB (German Civil Code)).

In case of his withdrawal, the customer shall be liable for any deterioration, destruction or loss of use resulting from any negligence or intent on his part. Any claims for damages or reimbursement of expenses of the customer shall be subject to the provisions set out in article 10.

In the case of any fraudulent concealment of a defect or in the case of any provision of a quality guarantee for the goods sold at the time of the passing of risk within the meaning of § 444 BGB (German Civil Code) (seller's declaration that the object sold has a specific property at the time of the passing of risk and that the seller, regardless of any fault on his part, intends to be answerable for any and all consequences resulting from its absence), the customer's rights shall be exclusively governed by the statutory provisions.

We shall - in addition to the statutory grounds for refusal - also be entitled to refuse subsequent performance if and as long as the customer fails to send us, at our request, the rejected goods or a sample thereof; the customer shall have no right of withdrawal for any such refusal. We may further refuse any subsequent performance if the goods concerned have been altered or modified without our consent unless the customer can prove that the defect was not caused by such alteration or modification.

The limitation period for any claims arising from defects shall be one year; in the case of goods which have been used in accordance with their intended purpose for a building and have caused its defectiveness, the limitation period shall be two years. The provisions of §§ 478, 479 BGB (German Civil Code) on recourse in the chain of suppliers shall not be affected thereby.

10. In the case of a pre-contractual, contractual or non-contractual breach of duty, including unsatisfactory delivery, tortious conduct and producer's liability, we shall only be liable for compensatory damages and reimbursement of expenses - subject to further contractual or statutory liability requirements - in the case of intent, gross negligence or slightly negligent breach of a material contractual duty (contractual duty the infringement of which jeopardises the fulfilment of the object of the contract). However - except in the case of intent - our liability shall be limited to the typical contractual damage that was foreseeable at the time the contract was entered into.

The purchaser shall not be permitted to make a claim for expenses incurred in vain. Except for any breach of material duties, our liability for slight negligence shall be excluded, but in any case be limited to the amount of the purchase price.

Any claim asserted by the customer or a third party for payment of a contractual penalty shall be excluded.

With regard to damages caused by delay, we shall only be liable for slight negligence up to the amount of 5% of the purchase price agreed with us.

The exclusions and limitations of liability set forth above shall not apply in the event that a guarantee is given with respect to the quality of the object sold within the meaning of § 444 BGB (German Civil Code) if a defect is fraudulently concealed or in the event of injury to life, physical injury or injury to health, or strict liability under the German Product Liability Act.

Any and all claims for damages against us, for any legal reason whatsoever, shall become statute-barred at the latest after one year from delivery of the goods to the customer, in the case of tortious liability from the time of knowledge, or grossly negligent ignorance, of the circumstances giving rise to the claim and the person liable to pay damages. This provision shall not apply in the case of liability for intent and in the event that a guarantee is given for the quality of the object sold, in the case of fraudulent concealment of a defect or in the event of injury to life, physical injury or injury to health, or strict liability under the German Product Liability Act. Any shorter limitation periods shall take precedence.

11. We shall be entitled to process and store any customer data obtained with regard to or in connection with the business relationship in accordance with the German Federal Data Protection Act, irrespective of whether such data is provided by the purchaser himself or by any third parties.

12. Place of performance for delivery and payment is Menden/Sauerland. The court of competent jurisdiction for any and all disputes, including disputes with regard to bills of exchange and cheques, is the Local Court (Amtsgericht) of Menden or, at our option, the District Court (Landgericht) of Arnsberg, irrespective of the value of the object in dispute. We shall, however, also be entitled to take legal proceedings against the customer at the place of his registered office.

German law shall be exclusively applicable. The application of international purchase laws is hereby excluded.

Should, for any reason whatsoever, individual provisions of our terms and conditions of sale and delivery be invalid, the validity and binding nature of the other provisions shall not be affected thereby. The customer agrees, that the invalid provision shall be replaced by a valid provision that comes as close as possible to the economic meaning of the invalid provision.

13. The prices of products made of brass and copper are subject to certain fluctuations that are based on the relevant DEL listings. The prices of our brass articles are based on a DEL listing of € 150 for Ms 58, those of our copper products on a DEL value for electrolyte copper of € 200.

In case of any increase or reduction in these prices by more than € 15, a five per cent surcharge or deduction shall be made for each 15 points. The calculation of any such surcharges or deductions shall be based on the DEL listing of the date of our receipt of the order.

Valid from January 2010



## Terms and conditions of sale and delivery of OBO BETTERMANN GmbH & Co. KG, OBO BETTERMANN Projekt und Systemtechnik GmbH and OBO Befestigungselemente GmbH, Menden.

1. All our supplies and services shall be governed exclusively by the following terms and conditions, including our additional terms and conditions for cable tray business transactions. Any terms and conditions of business and purchasing of the customer shall be valid only if we have acknowledged them in writing. Our quotations are without engagement; they are mere invitations to submit contract offers. Any and all transactions and agreements, including those entered into by our employees and agents shall only be binding upon our written confirmation or invoicing. The foregoing provision shall also apply to any modifications of the agreed formal requirements.

2. The documents and data pertaining to the quotation, such as illustrations, brochures, drawings, dimensions, loading capacity values and weight details are approximate only, unless they are expressly stipulated to be binding.

Samples are non-binding samples for inspection. Any purchase according to sample will be subject to customary deviations and deviations resulting from normal production processes. The properties of the sample shall be no guaranteed quality of the purchase object unless expressly stated otherwise in the confirmation of order. Samples must be returned to us at the latest within four weeks in perfect condition. If they are not returned within this period in proper condition, we shall be entitled to charge the purchase price for the sample in accordance with our current price list. All information on our products, in particular the illustrations, drawings, weight, dimension and performance data included in our quotations and printed matter shall be regarded as approximate average values and shall not represent any quality guarantee.

With regard to products made according to customer drawings, samples and other instructions of the customer, we will not provide any warranty nor assume any liability for the due and proper functioning of the product or for any other defects if and to the extent they are based upon the customer's specifications. The customer shall indemnify us from any third party claims, including claims for product liability as may be asserted against us for damages resulting from the products unless we have caused such damages by intent or gross negligence. The customer shall warrant that the manufacture and supply of products made in accordance with his instructions will not infringe any proprietary rights of third parties. Should any proprietary rights be asserted against us, we shall be entitled, without any legal review of the third party claims, to withdraw from the contract after hearing the customer, unless the third party withdraws the claims asserted against us under its proprietary rights within eight days by written declaration. The customer shall compensate us for any damage sustained as a result of the assertion of proprietary rights. In case of withdrawal, the work we have carried out so far shall be remunerated. Further rights under the statutory provisions shall not be affected thereby.

Any moulds, tools and design data produced by us for the execution of the order shall be our exclusive property. Unless expressly agreed otherwise, the customer shall not have any claims thereto, even if he has contributed to the costs of producing any such moulds, tools and design data.

3. The packing, shipping route and means of transportation shall be left to our discretion in the absence of any other agreements. They shall be charged at their cost price. We will take back undamaged cases, when being returned carriage paid, at 2/3 of the amount invoiced. The one-way or pool pallets used for transport shall be either exchanged upon taking delivery or returned. The smallest packing units stocked and listed may not be broken up for rationalisation reasons. In case of orders for different quantities, the nearest packing unit will be supplied.

We reserve the right to deviate from the agreed delivery quantity, in particular in the case of custom-made products, to a customary extent or in conformity with national or international standards. In case of a demand for adhering to a precise quantity, an express reference is necessary and subject to confirmation.

Master and call orders shall oblige the customer to accept the total quantity on which the master/call order is based. Where no particular call orders are specified in the contract, the total quantity of the master call order must be called within twelve months. If the customer fails to adhere to call deadlines, we shall be entitled to deliver and charge the total quantity in full after four weeks from written notice with reference to the consequences of any failure to call. Our rights arising from any default of the customer shall not be affected thereby.

4. Unless otherwise agreed, our prices are quoted ex works and do not include packing and insurance. The value added tax at the rate applicable on the date of dispatch will be added to our prices. The purchaser shall ensure the correctness of his VAT identification number, which he must notify to us immediately without being asked. He shall undertake to inform both us and the competent domestic tax authority without delay of any change in his name, address and VAT identification number.

Delivery shall be franco domicile within Germany, i.e. carriage and packing prepaid, if the net order value is in excess of € 1,200. For small orders below € 100 (net excluding value added tax), we shall invoice a lower quantity surcharge of € 10 (net) per order. Upon transfer of our supplies and services to a carrier or forwarding agent, at the latest upon their leaving our warehouse or supply plant, the risk shall pass to the recipient, even in case of deliveries free place of destination.

5. Delivery periods and delivery deadlines shall be approximate only unless we have expressly stated in writing that they are binding. Delivery periods shall commence upon receipt of our confirmation of order, but not before clarification of all execution details, ex place of delivery. The customer shall only be entitled to withdraw from the contract after having granted a reasonable extension of time. We reserve the right to make partial deliveries. Claims for damages and reimbursement of expenses - for any reason whatsoever - shall be subject to the provisions set out in article 10.

In the event of any circumstances that are beyond our control within the scope of normal operating risks and obstruct or make impracticable any delivery, we shall be entitled to suspend delivery by the duration of such obstruction plus a reasonable start-up period or to withdraw from the contract for the part not yet fulfilled. The purchaser can demand a statement from us as to whether we wish to deliver within a reasonable period or withdraw. If we fail to make such a statement, the purchaser may withdraw. Our notice to the purchaser shall be deemed to be sufficient evidence that we have been prevented from delivering.

Delivery time is extended in case of such events as labour disputes, strikes and lockouts, orders from the authorities, difficulties with the procurement of materials, spoiled work or post-processing, shutdowns and staff shortage as well as shortage of means of transport, and general occurrence of unforeseen events beyond our scope of influence, by the length of duration of these events.

6. Payments shall be made upon receipt of invoice less a 3% cash discount for payment within 10 days or net after 30 days from date of invoice. Erection work and all paid labour work must be paid within 10 days without deduction of any cash discount. In case of non-cash payments, the date of the credit note will be deemed to be the date of receipt of payment. Payments received shall always be credited first against costs, then against interest and then against the earliest liability. Cheques and bills of exchange shall only be accepted as means of payment.

Any payment by bill of exchange shall be subject to a prior separate and written agreement, whereby all bill costs shall be borne by the customer and no discount can be granted. The customer shall have no right to refuse performance and no right of retention - for any legal reason whatsoever - unless we have acknowledged his claim beforehand in writing or his claim has the force of law.

The customer shall only be entitled to set off claims which have the force of law, are undisputed or acknowledged by us in writing.

7. We shall retain title to the goods supplied by us until all our claims arising from our business transactions with the customer have been satisfied - current account clause - and all bills of exchange or cheques submitted for payment by the customer have been honoured.

Any treatment or processing of goods subject to our retention of title (reserved goods) shall be carried out for us as the manufacturer in accordance with § 950 BGB (German Civil Code) without any obligation on our part. If our reserved goods are to be regarded as the main item or the main item is owned by the customer, full title to the new item shall pass to us when it is created. In other cases, we shall acquire a co-ownership interest in the new item in the proportion of the sales value of our reserved goods to the other goods used for the new item at the time of processing, intermingling, joining or mixing. The customer shall take custody of our ownership or co-ownership interest free of charge; it shall be treated as reserved goods.

Before transfer of title, our goods shall be neither pledged nor assigned as collateral without our prior consent. In addition, any third party rights or pledges shall be notified to us immediately and we shall be given all details and provided all documents necessary for intervention; otherwise the customer must bear our loss. In the latter case, our total claims against the customer shall also be immediately payable.

The customer shall be entitled to sell or to use our reserved goods in the ordinary course of business subject to the condition that the relevant claims are transferred in accordance with article 8 below. This right shall lapse upon the customer's failure to promptly meet his payment obligations towards us or in the event of any cheque or bill protests or his suspension of payments. In such cases, we shall be entitled to take back the goods provisionally at

the customer's expense and to sell them at our duly exercised discretion after a corresponding reminder has been sent to the customer. We will then pass the due amount to the customer's credit.

8. If our goods are sold before payment of our claim, the customer shall be obliged to retain our title against his purchaser until the goods have been paid for in full by the purchaser. The claim arising against the purchaser from such resale as well as any other ancillary rights or security interests of the customer resulting from the sale and any claims for compensation in case of damage to or destruction of our reserved property, including the relevant insurance sum shall hereby be assigned to us. We hereby accept this assignment. Where our co-ownership interest is sold, the relevant claims shall be assigned in the amount corresponding to the value of our interest.

The customer shall, at our request, inform us of his purchasers, notify them of the assignment made and provide us with any and all documents required to assert our rights.

As long as the customer meets his contractual obligations without delay, he shall be authorised to collect the claims assigned. He shall keep the amounts collected on our behalf separately and remit them to us immediately as soon and as far as our claims become due. The authorisation shall lapse in case of any cheque or bill protest of the customer or his definite suspension of payments. The customer shall bear the costs incurred for any action taken against third parties and shall advance them upon request.

If the security provided to us by the retention of title and the anticipatory assignment should exceed the claims to be secured by more than 20%, we shall, at the customer's request, release paid supplies of our choice. Upon payment of all our claims by the customer, assigned claims shall pass to the customer.

9. Any complaints for obvious defects regarding the quantity or quality of our supplies and services that are identifiable upon careful inspection shall without delay, but at the latest within the period of limitation of eight days from arrival of the goods at the address of the customer or the person appointed by him, be notified in writing to us, not to our representatives. Slight deviations in dimensions and designs within the scope of defined technical tolerances shall not give rise to any right of complaint. Any rejected goods may only be returned to us with our prior written authorisation.

In case of justified complaints within the prescribed period, we shall, at our option, take remedial action by way of subsequent performance, by rectifying the defect, supplying non-defective goods or providing a credit note for the lower value calculated.

We shall be entitled to refuse subsequent performance in accordance with the statutory provisions. If we refuse subsequent performance, if any subsequent performance remains unsuccessful or if the customer cannot be reasonably expected to accept any subsequent performance, the latter shall be entitled to withdraw from the contract in compliance with the provisions of the following sentences. The customer shall only be entitled to withdraw from the contract - where a withdrawal is not excluded by law - upon the unsuccessful expiry of a reasonable period for subsequent performance set by him, unless this period was not required under the statutory provisions (§§ 281 para. 2, 323 para. 2, 440, 441 para. 1 BGB (German Civil Code)).

In case of his withdrawal, the customer shall be liable for any deterioration, destruction or loss of use resulting from any negligence or intent on his part. Any claims for damages or reimbursement of expenses of the customer shall be subject to the provisions set out in article 10.

In the case of any fraudulent concealment of a defect or in the case of any provision of a quality guarantee for the goods sold at the time of the passing of risk within the meaning of § 444 BGB (German Civil Code) (seller's declaration that the object sold has a specific property at the time of the passing of risk and that the seller, regardless of any fault on his part, intends to be answerable for any and all consequences resulting from its absence), the customer's rights shall be exclusively governed by the statutory provisions.

We shall - in addition to the statutory grounds for refusal - also be entitled to refuse subsequent performance if and as long as the customer fails to send us, at our request, the rejected goods or a sample thereof; the customer shall have no right of withdrawal for any such refusal. We may further refuse any subsequent performance if the goods concerned have been altered or modified without our consent unless the customer can prove that the defect was not caused by such alteration or modification.

The limitation period for any claims arising from defects shall be one year; in the case of goods which have been used in accordance with their intended purpose for a building and have caused its defectiveness, the limitation period shall be two years. The provisions of §§ 478, 479 BGB (German Civil Code) on recourse in the chain of suppliers shall not be affected thereby.

10. In the case of a pre-contractual, contractual or non-contractual breach of duty, including unsatisfactory delivery, tortious conduct and producer's liability, we shall only be liable for compensatory damages and reimbursement of expenses - subject to further contractual or statutory liability requirements - in the case of intent, gross negligence or slightly negligent breach of a material contractual duty (contractual duty the infringement of which jeopardises the fulfilment of the object of the contract). However - except in the case of intent - our liability shall be limited to the typical contractual damage that was foreseeable at the time the contract was entered into.

The purchaser shall not be permitted to make a claim for expenses incurred in vain. Except for any breach of material duties, our liability for slight negligence shall be excluded, but in any case be limited to the amount of the purchase price.

Any claim asserted by the customer or a third party for payment of a contractual penalty shall be excluded.

With regard to damages caused by delay, we shall only be liable for slight negligence up to the amount of 5% of the purchase price agreed with us.

The exclusions and limitations of liability set forth above shall not apply in the event that a guarantee is given with respect to the quality of the object sold within the meaning of § 444 BGB (German Civil Code) if a defect is fraudulently concealed or in the event of injury to life, physical injury or injury to health, or strict liability under the German Product Liability Act.

Any and all claims for damages against us, for any legal reason whatsoever, shall become statute-barred at the latest after one year from delivery of the goods to the customer, in the case of tortious liability from the time of knowledge, or grossly negligent ignorance, of the circumstances giving rise to the claim and the person liable to pay damages. This provision shall not apply in the case of liability for intent and in the event that a guarantee is given for the quality of the object sold, in the case of fraudulent concealment of a defect or in the event of injury to life, physical injury or injury to health, or strict liability under the German Product Liability Act. Any shorter limitation periods shall take precedence.

11. We shall be entitled to process and store any customer data obtained with regard to or in connection with the business relationship in accordance with the German Federal Data Protection Act, irrespective of whether such data is provided by the purchaser himself or by any third parties.

12. Place of performance for delivery and payment is Menden/Sauerland. The court of competent jurisdiction for any and all disputes, including disputes with regard to bills of exchange and cheques, is the Local Court (Amtsgericht) of Menden or, at our option, the District Court (Landgericht) of Arnsberg, irrespective of the value of the object in dispute. We shall, however, also be entitled to take legal proceedings against the customer at the place of his registered office.

German law shall be exclusively applicable. The application of international purchase laws is hereby excluded.

Should, for any reason whatsoever, individual provisions of our terms and conditions of sale and delivery be invalid, the validity and binding nature of the other provisions shall not be affected thereby. The customer agrees, that the invalid provision shall be replaced by a valid provision that comes as close as possible to the economic meaning of the invalid provision.

13. The prices of products made of brass and copper are subject to certain fluctuations that are based on the relevant DEL listings. The prices of our brass articles are based on a DEL listing of € 150 for Ms 58, those of our copper products on a DEL value for electrolyte copper of € 200.

In case of any increase or reduction in these prices by more than € 15, a five per cent surcharge or deduction shall be made for each 15 points. The calculation of any such surcharges or deductions shall be based on the DEL listing of the date of our receipt of the order.

Valid from January 2010





#### **QR-Code**

With the QR Code you have direct access to our products on the Internet.

You can find further information on the QR Code at [www.obo-bettermann.com](http://www.obo-bettermann.com).

#### **OBO BETTERMANN GmbH & Co. KG**

P.O. Box 1120  
58694 Menden, Germany

#### **Customer Service Germany**

Tel. +49 (0)2373 89-1500  
Fax +49 (0)2373 89-7777  
E-mail: [info@obo.de](mailto:info@obo.de)

[www.obo-bettermann.com](http://www.obo-bettermann.com)