

TBS | Catalogue 2012/2013



# Transient and lightning protection systems

THINK CONNECTED.

## Welcome to Customer Service

---

**Service telephone: +49 (0)2373 89-1500**

---

**Telefax for enquiries: +49 (0)2373 89-7777**

---

**Fax for orders: +49 (0)2373 89-7755**

---

**E-mail: [info@obo.de](mailto:info@obo.de)**

**Internet: [www.obo-bettermann.com](http://www.obo-bettermann.com)**



Use the direct line to OBO Customer Service! We are available on our Service Hotline on +49 (0)2373 89-1500 from 7.30 a.m. to 5.00 p.m. for any questions to do with the OBO complete product range for electrical installations. The newly structured OBO Customer Service can offer you the full service:

- Competent contacts from your region
- All the information on the OBO product range
- Knowledgeable advice on special application topics
- Quick, direct access to all the technical data of the OBO products – we also want to provide the best in customer relations!

# Contents

	Planning aids	5
	Surge protection energy technology, arrester, Type 1	135
	Surge protection energy technology, arrester, Type 1+2	145
	Surge protection energy technology, arrester, Type 2	173
	Surge protection energy technology, arrester, Type 2+3	199
	Surge protection energy technology, arrester, Type 3	209
	Sure protection, photovoltaics	219
	Data and information technology	235
	Protection and spark gaps	287
	Measuring and test systems	291
	Equipotential bonding systems	295
	Earthing systems	309
	Interception and arrester systems	329
	Insulated lightning protection and OBO isCon® system	381
	Directories	397





#### **OBO TBS seminars: First-hand knowledge**

With a comprehensive programme of training courses and seminars on the subject of surge voltage and lightning protection systems, OBO is able to support its customers with specialist knowledge from a single source. Alongside the basic theoretical principles, the programme also deals with practical implementation in everyday applications. Special calculation and application examples round off the comprehensive programme of knowledge transfer.

#### **Invitations to tender, product information and datasheets**

We can make life easier for you: With our comprehensive selection of materials designed for practical applications, which provide you with effective support with the planning and calculation of a project. These include:

- Invitations to tender
- Product information
- Information sheets
- Datasheets









These documents are continually updated and can be downloaded at no charge at any time from the Internet download area at [www.obo.de](http://www.obo.de).

#### **Invitations to tender on the Internet at [www.ausschreiben.de](http://www.ausschreiben.de)**

More than 10,000 entries from the KTS, BSS, TBS, LFS, EGS and UFS ranges can be called up free of charge. Regular updates and expansions mean that you always have a comprehensive overview of the OBO products. All the current file formats – PDF, DOC, GAEB, HTML, TEXT, XML, ÖNORM – are available.

[www.ausschreiben.de](http://www.ausschreiben.de)

## Contents of planning and mounting aids

	Basic principles of surge voltage protection	6
	Surge protection energy technology	19
	Sure protection, photovoltaics	27
	Surge protection device for data and information technology	43
	Protection and spark gaps	65
	Measuring and test systems	69
	Equipotential bonding systems	73
	Earthing systems	77
	Interception and arrester systems	87
	Insulated lightning protection and OBO isCon® system	113
	Additional information	126



## Minor cause, major effect: Damage caused by surge voltages



Our dependency on electrical and electronic equipment continues to increase, in both our professional or private lives. Data networks in companies or emergency facilities such as hospitals and fire stations are lifelines for an essential real time information exchange. Sensitive databases, e.g. in banks or media publishers, need reliable transmission paths.

It is not only lightning strikes that pose a latent threat to these systems. More and more frequently, today's electronic aids are damaged by surge voltages caused by remote lightning discharges or switching operations in large electrical systems. During thunderstorms too, high volumes of energy are instantaneously released. These voltage peaks can penetrate a building through all manner of conductive connections and cause enormous damage.





### What are the consequences of damage caused by surge voltages in our daily lives?

The most obvious one is the destruction of electrical equipment. In private households, these are specifically:

- TV/DVD players
- Telephone systems
- Computer systems, stereo systems
- Kitchen appliances
- Monitoring systems
- Fire alarm systems

The failure of such equipment certainly incurs great expense. What happens when the following suffer outage times / consequential damage:

- Computers (loss of data)
- Heating/water heating systems
- Lift, garage door and roller shutter drives
- Triggering or destruction of fire / burglar alarm systems (costs through a false alarm)?

A vital topic perhaps, particularly in office buildings, because:

- Can work continue in your company without a central computer / server?
- Was all the important data backed up in time?

### Growing sums of damage

Current statistics and estimates of insurance companies show: Damage levels caused by surges – excluding consequential or outage costs – long since reached drastic levels due to the growing dependency on electronic "aids". It's no surprise, then, that property insurers are checking more and more claims and stipulating the use of devices to protect against surges. Information on protection measures is contained, e.g. in Directive VDS 2010.







## Creation of lightning discharges



Creation of lightning discharges: 1 = approx. 6,000 m, approx.  $-30\text{ }^{\circ}\text{C}$ , 2 = approx. 15,000 m, approx.  $-70\text{ }^{\circ}\text{C}$

### Discharge types

Some 90% of all lightning discharges between a cloud and the ground are negative cloud-earth strikes. The lightning begins in a negatively charged area of the cloud and spreads to the positively charged surface of the earth. Additional discharges are divided into:

- Negative earth-cloud strikes
- Positive cloud-earth strikes
- Positive earth-cloud strikes.

The most common discharges actually occur within a cloud or between different clouds.

### Creation of lightning discharges

When warm, damp air masses rise, the air humidity condenses and ice crystals are formed at great heights. Storm fronts can occur when the clouds expand to heights of up to 15,000 m. The strong upwind of up to 100 kilometres per hour causes the light ice crystals to enter the higher area and the sleet particles enter the lower area. Knocks and friction cause electrical discharge.





### Negative and positive charges

Studies have proved that the sleet falling down (area warmer than  $-15\text{ }^{\circ}\text{C}$ ) has a negative charge and the ice crystals being thrown upwards (area colder than  $-15\text{ }^{\circ}\text{C}$ ) has a positive charge. The light ice crystals are carried into the upper areas of the cloud by the upwind and the sleet falls to the central areas of the cloud. This divided the clouds into the three areas:

- Top: Positively charged zone
- Centre: Weakly negative charged zone
- Bottom: Weakly positive charged zone

This separation of charges forms a voltage in the cloud.



Negative and positive charges: 1 = Sleet, 2 = Ice crystals

### Load distribution

Typical load distribution:

- Positive at the top, negative in the centre and weakly positive at the bottom.
- Positive charges can also be found in the area near the ground.
- The field strength required to trigger lightning is dependent on the insulating ability of the air and is between 0.5 and 10 kV/cm.



Charge distribution: 1 = approx. 6,000 m, 2 = Electrical field



## What are transient surges?

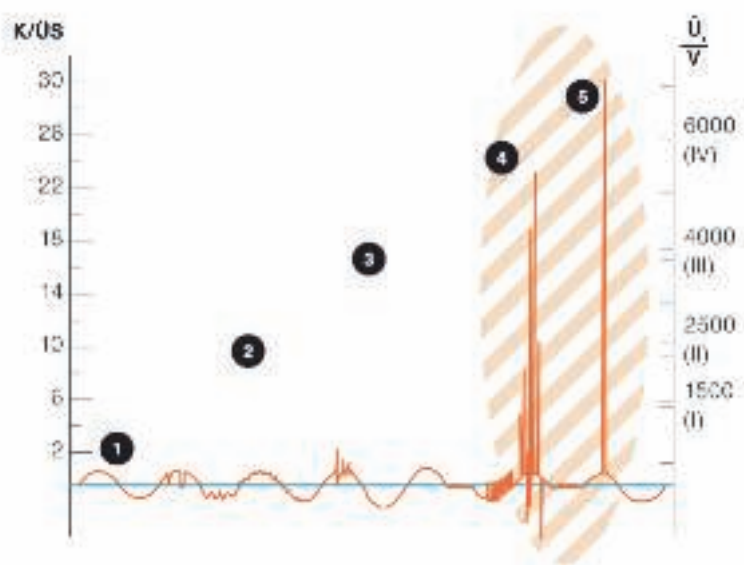

Transient surge voltages: 1 = Voltage drops/brief interruptions, 2 = Harmonic waves through slow and rapid voltage changes, 3 = Temporary voltage increases, 4 = Switching surges, 5 = Lightning surge voltages, hatched = application for surge protection devices

**Transient surge voltages are brief voltage peaks lasting microseconds, which may be a multiple of the attached mains nominal voltage.**

### Direct strike

The largest voltage peaks in the low-voltage consumer network are caused by lightning discharges. The high energy content of lightning surges when a direct strike hits the external lightning protection system or a low-voltage open-wire line usually causes – without internal lightning and surge protection – total outage of the connected consumers and damage to the insulation.

### Induced voltage peaks and switching surge voltages

Yet induced voltage peaks in building installations and energy or data line supply cables can also reach many times the nominal operating voltage. Switching surges too, which in fact do not cause such high voltage peaks as lightning discharges but occur much more frequently, can result in immediate system failure. As a rule, switching surges amount to twice to three times the operating voltage, lightning surges on the other hand can sometimes reach 20 times the nominal voltage value and transport a high energy content.

### Delayed failures

Often, failures occur only after a time delay as the aging process of electronic components in the affected devices triggered by smaller transients causes insidious damage. A number of different protection measures are required. These depend on the exact cause and/or impact point of the lightning discharge.



## What pulse forms are there?

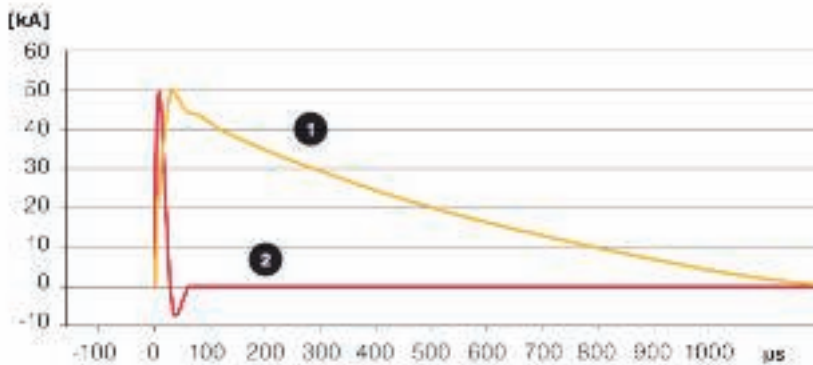

Pulse types and their characteristics: Yellow = pulse shape 1, direct lightning strike, 10/350  $\mu\text{s}$  simulated lightning pulse, red = pulse shape 2, remote lightning strike or switching operation, 8/20  $\mu\text{s}$  simulated lightning pulse (Surge)

### Testing currents simulate potential increase

High lightning currents can flow to the ground during a storm. If a building with external lightning protection receives a direct hit, a voltage drop occurs on the earthing resistor of the lightning protection equipotential bonding system, which represents a surge voltage against the distant environment. This rise in potential poses a threat to the electrical systems (e.g. voltage supply, telephone systems, cable TV, control cables, etc.) that are routed into the building. Suitable test currents for testing different lightning and surge protectors have been defined in national and international standards.

### Direct lightning strike: Pulse shape 1

Lightning currents that can occur during a direct lightning strike can be imitated with the surge current of wave form 10/350  $\mu\text{s}$ . The lightning test current imitates both the fast rise and the high energy content of natural lightning. Lightning current arrester type 1 and external lightning protection components are tested using this current.

### Remote lightning strikes or switching operations: Pulse shape 2

The surges created by remote lightning strikes and switching operations are imitated with test impulse 8/20  $\mu\text{s}$ . The energy content of this impulse is significantly lower than the lightning test current of surge current wave 10/350  $\mu\text{s}$ . Surge arrester type 2 and type 3 are impacted with this test impulse.



## Causes of lightning currents

### Direct lightning strike into a building

If a lightning strike hits the external lightning protection system or earthed roof structures capable of carrying lightning current (e.g. roof aerial), then the lightning energy can be arrested to the ground in advance. However, a lightning protection system on its own is not enough: Due to its impedance, the building's entire earthing system is raised to a high potential. This potential increase causes the lightning current to spill over the building's earthing system and also over the power supply systems and data cables to the adjacent earthing systems (adjacent building, low-voltage transformer).

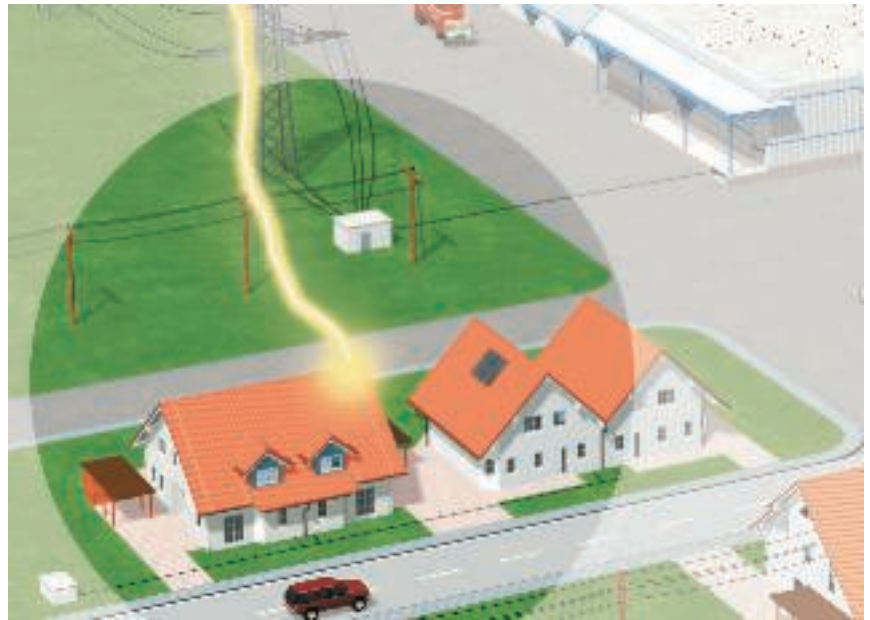

#### Risk:

**Lightning impulse (10/350)**

### Direct lightning strike into a low-voltage open-wire line

A direct lightning strike into a low-voltage open wire line or data cable can couple high partial lightning currents in an adjacent building. Electrical equipment in buildings at the end of the low-voltage open-wire line are at particular risk of damage caused by surges.

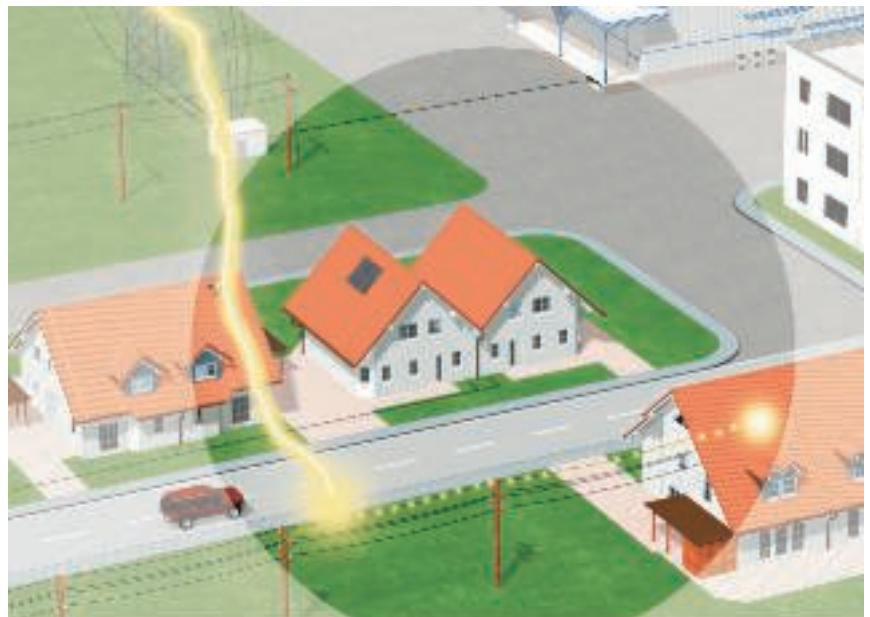

#### Risk:

**Lightning impulse (10/350)**





## Causes of surges

### Switching surges in the low-voltage system

Switching surges are caused by switch-on and switch-off operations, by switching inductive and capacitive loads and by interrupting short-circuit currents. Particularly when production plants, lighting systems or transformers are switched off, electrical equipment located in close proximity can be damaged.

---

**Risk:**  
Surge impulse (8/20)

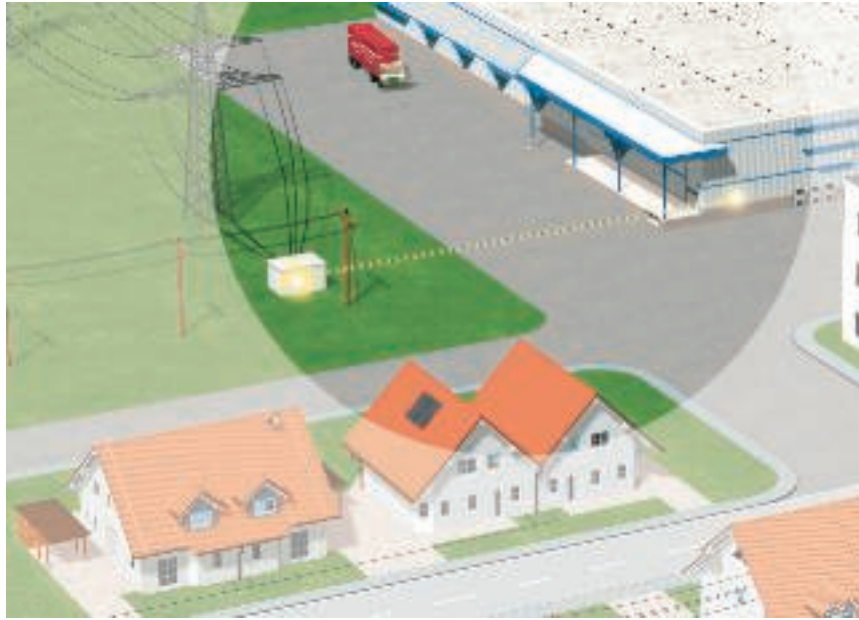

### Coupling of surges through local or remote lightning strike

Even if lightning protection and surge protection measures are already installed: A local lightning strike creates additional high magnetic fields, which in turn induce high voltage peaks in line systems. Inductive or galvanic coupling can cause damage within a radius of up to 2 km around the lightning impact point.

---

**Risk:**  
Surge impulse (8/20)

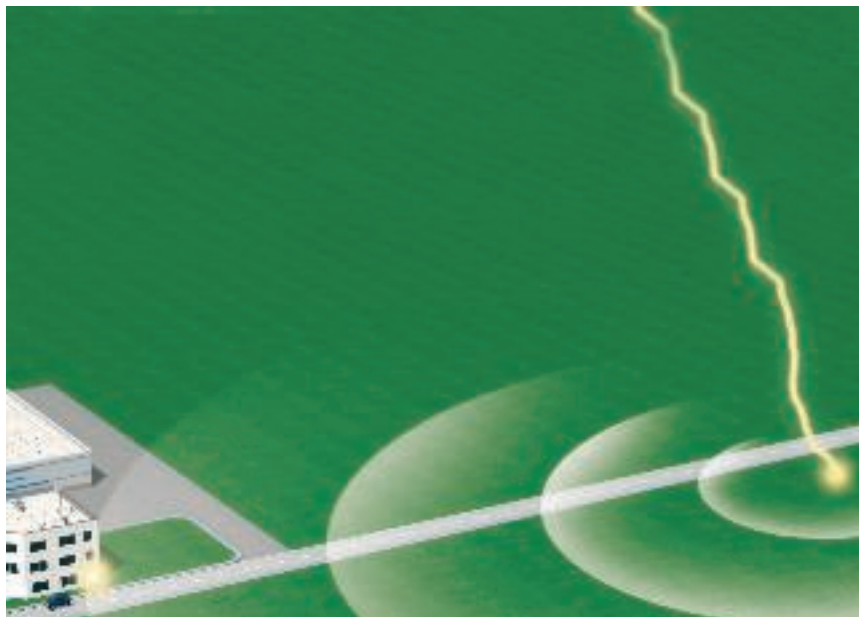



## Gradual surge reduction with lightning protection zones



### Lightning protection zone concept

The lightning protection zone concept described in international standard IEC 62305-4 (DIN VDE 0185 Part 4) has proved to be practical and efficient. This concept

is based on the principle of gradually reducing surges to a safe level before they reach the terminal device and cause damage. In order to achieve this situation, a building's entire energy network is split into lightning protection zones (LPZ = Lightning Protec-

tion Zone). Installed at each transition from one zone to another is a surge arrester for equipotential bonding. These arrestors correspond to the requirement class in question.

### Lightning protection zone

LPZ 0 A		Unprotected zone outside the building. Direct lightning strike, no shielding against electromagnetic interference pulses LEMP (Lightning Electromagnetic Pulse)
LPZ 0 B		Through the area protected by the external lightning protection system. No shielding against LEMP.
LPZ 1		Zone inside the building. Low partial lightning energies possible.
LPZ 2		Zone inside the building. Low surges possible.
LPZ 3		Zone inside the building (can also be the metal housing of a consumer). No interference pulses through LEMP or surges present.





## Zone transitions and protective devices

### Benefits of the lightning protection zone concept

- Minimisation of the couplings into other cable systems through arresting the energy-rich, dangerous lightning currents directly at the point the cables enter the building.
- Malfunction prevention with magnetic fields.
- Economic, well-plannable individual protection concept for new and old buildings and reconstructions.



### Type classes of the surge protection devices

OBO surge protection devices are classified in accordance with DIN EN 61643-11 into three type classes – type 1, type 2 and type 3 (previously B, C and D). These standards contain building regulations, requirements and tests for surge arrestors used in AC networks with nominal voltages of up to 1,000 V and nominal frequencies of between 50 and 60 Hz.

### Correct selection of the arrestor

This classification enables arrestors to be matched to different requirements with regard to location, protection level and current-carrying capacity. The table below provides an overview of the zone transitions. It also shows which OBO surge protection devices can be installed in the energy supply network and their respective function.

### Zone transitions

Zone transition	Protection device and device type	Product example	Product figure
LPZ 0 B to LPZ 1	Protection device for lightning protection equipotential bonding in accordance with DIN VDE 0185-3 for direct or close lightning strikes. <ul style="list-style-type: none"> <li>• Devices: type 1 (Class I, requirements class B), e.g. MC50-B</li> <li>• Max. protection level according to standard: 4 kV</li> <li>• Installation e.g. in the main distributor/at building entry</li> </ul>	MCD Item no.: 5096 87 9	
LPZ 1 to LPZ 2	Protection device for surge protection to DIN VDE 0100-443 for surge voltages arriving through the supply network due to remote strikes or switching operations. <ul style="list-style-type: none"> <li>• Devices: type 2 (Class II, requirements class C), e.g. V20-C</li> <li>• Max. protection level according to standard: 2.5 kV</li> <li>• Installation e.g. in the power distributor, subdistributor</li> </ul>	V20 Item no.: 5094 65 6	
LPZ 2 to LPZ 3	Protection device, designed for surge protection of portable consumers at sockets and power supplies. <ul style="list-style-type: none"> <li>• Devices: type 3 (Class III, requirements class D), e.g. FineController FC-D</li> <li>• Max. protection level according to standard: 1.5 kV</li> <li>• Installation e.g. on the end consumer</li> </ul>	FC-D Item no.: 5092 80 0	



## BET – testing centre for lightning protection, electrical engineering and support systems



Lightning current test

### BET with countless tasks

If only lightning current, environmental and electrical testing was possible at BET up to now, the BET Test Centre is now a competent partner for testing of cable support systems. This combination has made it necessary to revise the meaning of the name. If BET previously stood for "Blitzschutz- und EMV-Technologiezentrum" (Lightning protection and EMC technology centre), since 2009 these letters have meant BET Test centre for lightning protection, electrical engineering and support systems.

### Test generator for lightning current tests

The test generator planned in 1994 and completed in 1996 makes it possible to carry out lightning current tests at up to 200 kA. The generator was planned and constructed in cooperation with the Soest Technical College. Due to the intensive planning and scientific support in the construction of the test system, it has worked for 12 years without errors and meets current standardised test requirements.

### Testing tasks

The main load of the testing generator is generated through the testing of products from the TBS product division. For this, developmental tests of new developments, modifications to existing OBO products and also comparison tests with competitive products are carried out. These include lightning protection components, surge protection devices and lightning arrestors. Tests for lightning protection components are carried out according to DIN EN 50164-1, for spark gaps according to DIN EN 50164-3 and for lightning and surge protection devices according to DIN EN 61643-11. This is only a small amount of the testing standards used for tests in the BET Test Centre.



Load test

### Testing types for lightning and surge protection

Both lightning current tests and surge voltage tests can be carried out at up to 20 kV. A hybrid generator is used for these tests, which was also developed as part of a cooperation with the Soest Technical College. EMC testing of cable support systems can also be carried out using this test generator. All kinds of cable routing and cable support systems of up to 8 m length can be tested without any difficulties. Tests for electrical conductivity according to DIN EN 61537 are also carried out.

### Simulation of real environmental conditions

To carry out standardised tests on components intended for external use, they must be pretreated under real environmental conditions. This takes place in a salt spray trough and a sulphur dioxide testing chamber. Depending on the test, the test length and the concentration of the salt spray or sulphur dioxide in the testing chambers may vary. This means that it is possible to conduct tests according to IEC 60068-2-52, ISO 7253, ISO 9227 and EN ISO 6988.

### Testing cable support systems

The well-known KTS testing system, newly installed in the BET Test Centre, allows the investigation of the load capacities of any cable support system manufactured by OBO. The basis for this is DIN EN 61537 and VDE 0639. In the BET Test Centre, OBO Bettermann has a testing department in which products can be tested according to standards, even during the development phase.





# Planning aids, surge protection energy technology



Standards, surge protection	20
Installation instructions	21
4-cable networks	22
5-cable networks	23
Selection aid, energy technology	24



## Standards, surge protection



You must take various standards into account when erecting surge protection. You can find the most important specifications here.

Standard	Contents
<b>DIN VDE 0100-410 (IEC 60364-4-41)</b>	Low-voltage electrical installations – Part 4-41: Protection for safety – Protection against electric shock
<b>DIN VDE 0100-540 (IEC 60364-5-54)</b>	Low-voltage electrical installations – Part 5-54: Selection and erection of electrical equipment – Earthing arrangements, protective conductors and protective bonding conductors
<b>DIN VDE 0100-443 (IEC 60364-4-44)</b>	Low-voltage electrical installations – Part 4-44: Protection for safety – Protection against voltage disturbances and electromagnetic disturbances – Clause 443: Protection against surge voltages of atmospheric origin or due to switching
<b>DIN VDE 0100-534 (IEC 60364-5-53)</b>	Low-voltage electrical installations – Part 5-53: Selection and erection of electrical equipment – Isolation, switching and control – Clause 534: Devices for protection against surge voltages
<b>DIN EN 61643-11 (IEC 61643-1)</b>	Low-voltage surge protection devices – Part 11: Surge protection devices connected to low-voltage power systems – Requirements and tests



## Installation instructions

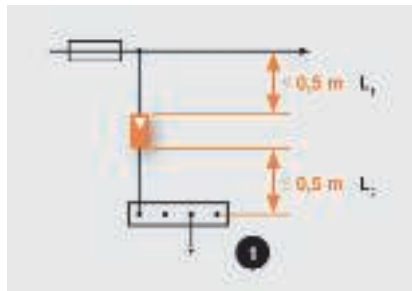

Length of the feed line, 1 = Equipotential bonding rail or terminal or protective conductor rail

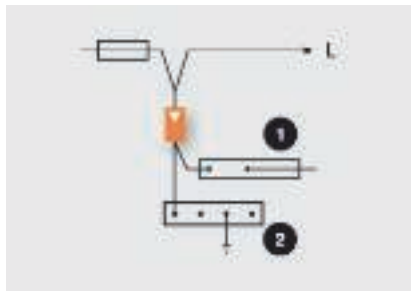

V wiring, 1 = Protective conductor rail, 2 = Main equipotential bonding rail or terminal

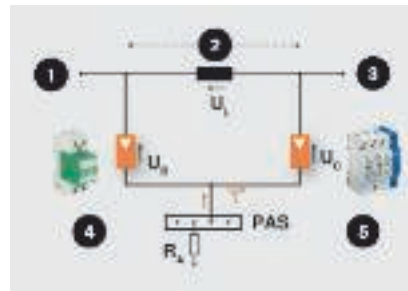

1= Power supply, 2 = Cable length, 3 = Consumer, 4 = Response voltage 2 kV, e.g. MC 50-B VDE 5 = Response voltage 1.4 kV, e.g. V20 C

### Minimum cross-sections for lightning protection equipotential bonding

The following minimum cross-sections must be observed for lightning protection equipotential bonding: for copper 16 mm<sup>2</sup>, for aluminium 25 mm<sup>2</sup> and for iron 50 mm<sup>2</sup>.

At the lightning protection zone, transition from LPZ0 to LPZ1, all metal installations must be integrated into the equipotential bonding system. Active lines must be earthed using suitable arrestors.

### Connection length, V-wiring

The connection cable to the protector is crucial for achieving an optimum protection level. In accordance with IEC installation directives, the length of the branch line to the arrestor and the length of the line from the protection device to the equipotential bonding should in each case be less than 0.5 m. If the cables are longer than 0.5 m, then V-wiring must be chosen.

### Decoupling

Lightning current and surge arrestors perform a number of functions. These arrestors must be used in coordination. This coordination is guaranteed by the existing line length or special lightning current arrestors (MCD series). For example, in the protection set, type 1 and type 2 arrestors (Classes B and C) can be used adjacent to each other.

#### Example cable length > 5 m

- No additional decoupling required

#### Example cable length < 5 m

- Use decoupling: MC 50-B VDE + LC 63 + V20-C
- Alternatively: MCD 50-B + V20-C, no additional decoupling required (e.g. protection set)

### Minimum dimensions of cables, protection class I to IV

Material	Cross-section of cables, which interconnect different equipotential bonding rails or which connect to the earthing system	Cross-section of cables, which connect the internal metallic installations with the equipotential bonding rail
Copper	16 mm <sup>2</sup>	6 mm <sup>2</sup>
Aluminium	25 mm <sup>2</sup>	10 mm <sup>2</sup>
Steel	50 mm <sup>2</sup>	16 mm <sup>2</sup>



## 4-cable networks, TN-C network system

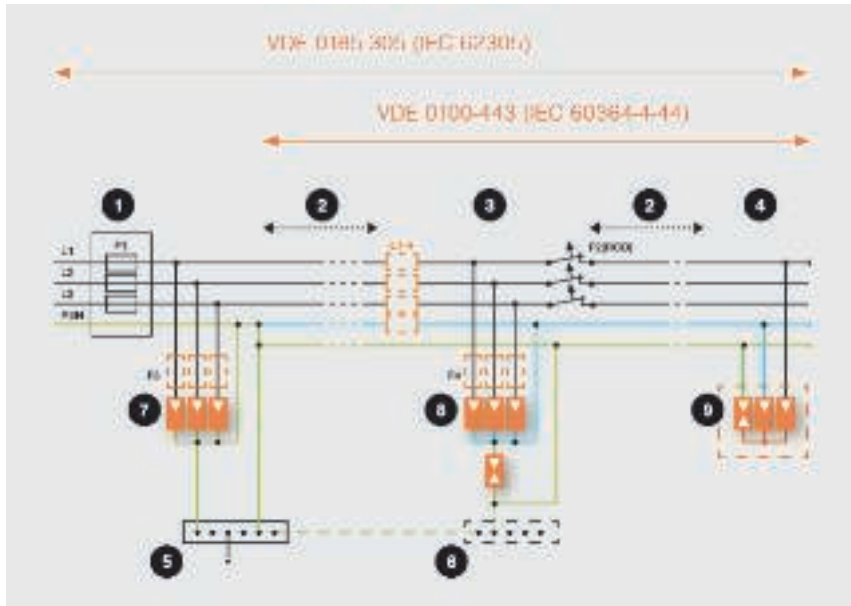

1 = Main distributor, 2 = Cable length, 3 = Circuit distributor, e.g. subdistributor, 4 = Fine power protection, 5 = Main EBS, 6 = Local EBS, 7 = Type 1, 8 = type 2, 9 = type 3

In the TN-C-S network system, the electrical unit is supplied through the three external lines (L1, L2, L3) and the combined PEN line. Usage is described in DIN VDE 0100-534 (DIN EN 61643-11).

### Lightning current arrester Type 1

Type 1 lightning current arresters are used in the 3-pole circuit (e.g.: 3x MC 50-B). The connection is effected parallel to the external lines, which are connected to the PEN via the arrester. Following consultation with the local energy provider and in accordance with the VDN Directive, use before the main meter device is also possible.

### Surge arrester, type 2

Surge arrestors of type 2 are usually used after the split in the PEN line. If the split is more than 0.5 m away, the network from here onwards is 5-line. The arrestors are used in the 3+1 circuit (e.g. V20-C 3+NPE). With the 3+1 circuit, the external lines (L1, L2, L3) are connected to the neutral cable (N) via arrestors. The neutral cable (N) is connected to the protective earth via a collective spark gap. The arrestors must be used before a residual current protective device (RCD), as it would otherwise interpret the surge current as a residual current and interrupt the power circuit.

### Surge arrester, type 3

Surge arrestors of type 3 are used to protect against surges in the device power circuits. These transverse surges occur primarily between L and N. A Y circuit protects the L and N lines with varistor circuits and makes the connections to the PE line through a collective spark gap (e.g. KNS-D). This protection circuit between L and N prevents surge currents from transverse voltages being conducted towards PE, the RCD thus interprets no residual current. The relevant technical data is contained on the product pages.

## 5-cable networks, TN-S and TT network system

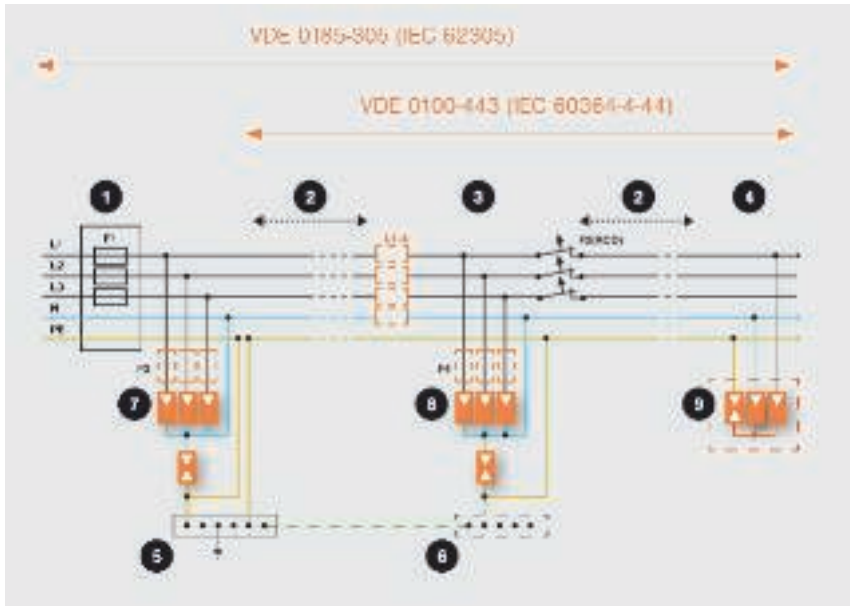

1 = Main distributor, 2 = Cable length, 3 = Circuit distributor, e.g. subdistributor, 4 = Fine power protection, 5 = Main EBS, 6 = Local EBS, 7 = Type 1, 8 = Type 2, 9 = Type 3

In the TN-S network system, the electrical unit is supplied through the three external lines (L1, L2, L3), the neutral cable (N) and the earth cable (PE). In the TT network, however, the electrical unit is supplied through the three external lines (L1, L2, L3), the neutral cable (N) and the earth cable (PE). Usage is described in DIN VDE 0100-534 (DIN EN 61643-11).

### Lightning current arrester type 1

Type 1 lightning current arrestors are used in the 3+1 circuit (e.g. 3x MC 50-B and one MC 125-B NPE). With the 3+1 circuit, the external lines (L1, L2, L3) are connected to the neutral cable (N) via arrestors. The neutral cable (N) is connected to the protective earth via a collective spark gap. Following consultation with the local energy provider and in accordance with the VDN Directive, use before the main meter device is also possible.

### Surge arrester, type 2

Surge arrestors of type 2 are used in the 3+1 circuit (e.g. V20-C 3+NPE). With the 3+1 circuit, the external lines (L1, L2, L3) are connected to the neutral cable (N) via arrestors. The neutral cable (N) is connected to the protective earth via a collective spark gap. The arrestors must be used before a residual current protective device (RCD), as it would otherwise interpret the surge current as a residual current and interrupt the power circuit.

### Surge arrester, type 3

Surge arrestors of type 3 are used to protect against surges in the device power circuits. These transverse surges occur primarily between L and N. A Y circuit protects the L and N lines with varistor circuits and makes the connection to the PE line through a collective spark gap (e.g. KNS-D). This protection circuit between L and N prevents surge currents from transverse voltages being conducted towards PE, the RCD thus interprets no residual current. The relevant technical data is contained on the product pages.













## Selection aid, energy technology

### AC combination arrester and surge protection; type 1+2, type 2 and type 3

















**Installation location 2  
Installation in the subdistributor  
Medium protection / type 2  
Only required if distance  $\geq 10\text{m}$**

Description	Type	Item no.	Product figure
TN/TT Type 2 + 3 2.5 SU	V10 Compact	<b>5093380</b> Page: 200	
	V10 Compact-AS, with acoustic remote signalling	<b>5093391</b> Page: 200	
TN/TT Type 2 4 SU	V20-C 3+NPE	<b>5094656</b> Page: 179	
	V20-C 3+NPE+FS with remote signalling	<b>5094765</b> Page: 180	
TN/TT Type 2 4 SU	V20-C 3+NPE	<b>5094656</b> Page: 179	
	V20-C 3+NPE+FS with remote signalling	<b>5094765</b> Page: 180	
TN/TT Type 2 4 SU	VC20-C 3+NPE	<b>5094656</b> Page: 179	
	V20-C 3+NPE+FS with remote signalling	<b>5094765</b> Page: 180	

02\_TBS\_Masterkatalog\_Länder\_2012 / en / 29/05/2012 (LLExpert\_01433) / 29/05/2012



## Test marks





	Lightning current-tested
	Lightning current-tested, Class H (100 kA)
	ELEKTROTECHNICKÝ ZKUŠEBNÍ ÚSTAV, Czech Republic
	ATEX certificate for explosive areas
	Russia, GOST The State Committee for Standards
	KEMA-KEUR, Netherlands
	Indication of metric products
	MAGYAR ELEKTROTECHNIKAI ELLENŐRZŐ INTÉZET Budapest, Hungary
	Österreichischer Verband für Elektrotechnik, Austria
	Underwriters Laboratories Inc., USA
	Eidgenössisches Starkstrominspektorat, Switzerland
	Underwriters Laboratories Inc., USA
	Verband der Elektrotechnik, Elektronik, Informationstechnik e.V., Germany
	German Association of Electricians, tested safety
	5-year warranty
	Halogen-free; without chlorine, fluorine and bromine











# Pictogram explanation



















## Lightning protection classes

	Protection device to DIN EN 61643-11 or IEC 61643-11
	Combination protection device made of type 1 and type 2
	Protection device to DIN EN 61643-11 or IEC 61643-11
	Protection device to DIN EN 61643-11 or IEC 61643-11
	Protection device to DIN EN 61643-11 or IEC 61643-11

## Lightning protection zone

	Transition from LPZ 0 to LPZ 1
	Transition from LPZ 0 to LPZ 2
	Transition from LPZ 0 to LPZ 3
	Transition from LPZ 1 to LPZ 2
	Transition from LPZ 1 to LPZ 3
	Transition from LPZ 2 to LPZ 3











## Applications

	Remote signalling
	Remote signalling with fuse monitoring
	Acoustic signalling
	Integrated Service Digital Network, ISDN applications
	Digital Subscriber Line, DSL applications
	Analogue telecommunication
	Category 5 TwisterPair
	Channel Performance to American EIA/TIA standard
	Measuring, controlling and regulating systems
	TV applications
	SAT-TV applications
	Multibase base
	LifeControl
	Intrinsically safe protection device for areas with a risk of explosions
	Channel Performance to ISO / IEC 11801
	Power over Ethernet
	230/400 V system
	Metric







## Applications

	Degree of protection of enclosure IP 65
---	---







## Metals

	Aluminium
	Stainless steel, grade 304
	Stainless steel, grade 316
	Stainless steel, grade 316 L
	Stainless steel, grade 316 Ti
	Copper
	Brass
	Steel
	Cast iron
	Die-cast zinc

## Plastics

	Fibre-glass-reinforced plastic
	Petrolatum
	Polyamide
	Polycarbonate
	Polyethylene
	Polypropylene
	Polystyrene

## Surfaces

	Strip-galvanised
	Hot-dip galvanised
	Electro-galvanised
	Hot-dip galvanised
	Copper-plated
	Nickel-plated
	Galvanised, Deltatone 500



## Metallic materials

**Alu** — Aluminium

**VA (1.4301)** — Stainless steel, grade 304

**VA (1.4401)** — Stainless steel, grade 316

**VA (1.4404)** — Stainless steel, grade 316 L

**VA (1.4571)** — Stainless steel, grade 316 Ti

**Cu** — Copper

**CuZn** — Brass

**St** — Steel

**TG** — Cast iron  
Electrogalvanised

**Zn** — Die-cast zinc

# Plastic materials

## GFK — Fibre-glass-reinforced plastic

Temperature resistance:  
-50 to 130 °C.

### Resistant to

High chemical resistance  
Corrosion resistance  
UV light resistance

## PETR — Petrolatum

## PA — Polyamide

Temperature resistance:  
permanently up to approx. 90 °C, briefly up to about 130 °C  
and to about minus 40 °C\*.

Chem. resistance generally as for polyethylene.

### Resistant to

Petrol, benzene, diesel oil, acetone, solvents for paints and lacquers,  
oils and greases.

### Unstable with

Bleach, most acids, chlorine.

### Risk of tension cracking

Low in air-humid conditions; only with some aqueous salt solutions.  
Highly desiccated parts (high temperature and extremely low air  
humidity) are highly sensitive to fuels and various solvents.

## PA/PP — Polyamide/Polyethylene

## PC — Polycarbonate

Temperature resistance:  
permanently up to approx. 110 °C (in water 60 °C), briefly up to 125  
°C, and to below minus 35 °C.

### Resistant to

Petrol, turpentine, most weak acids.

### Unstable with

Acetone, benzene, chlorine, methylene chloride, most concentrated  
acids.

### Risk of tension cracking

Relatively low.

Media which can cause tension cracking include benzene, aromatic  
hydrocarbons, methanol, butanol, acetone, turpentine.

## PE — Polyethylene

Temperature resistance:  
hard types permanently up to about 90 °C, briefly up to about 105 °C,  
soft types permanently up to about 80 °C, briefly up to about 100 °C  
and to about minus 40 °C\*.

### Resistant to

Alkalis and inorganic acids.

### Conditionally resistant to

Acetone, organic acids, petrol, benzene, diesel oil, most oils.

### Unstable with

Chlorine, hydrocarbons, oxidising acids.

### Risk of tension cracking

Relatively high.

Stress cracks can be caused by, among other things, acetone, various  
alcohols, formic acid, ethanol, petrol, benzene, butyric acid, acetic acid,  
formaldehyde, various oils, petroleum, propanol, nitric acid,  
hydrochloric acid, sulphuric acid, soap solutions, turpentine,  
trichloroethylene, citric acid.

## PP — Polypropylene

Temperature resistance:  
permanently up to approx. 90 °C, briefly up to about 110 °C  
and to about minus 30 °C\*.

Chem. resistance generally as for polyethylene.

### Resistant to

Alkalis and inorganic acids.

### Conditionally resistant to

Acetone, organic acids, petrol, benzene, diesel oil, most oils.

### Unstable with

Chlorine, hydrocarbons, oxidising acids.

### Risk of tension cracking

Low, only with some acids such as chromic acid, hydrofluoric acid and  
hydrochloric acid, as well as nitrogen oxide.

## PS — Polystyrene

Temperature resistance:

Because of its relatively high sensitivity to the effects of chemicals, its  
use is not recommended at temperatures above normal room  
temperature, about 25 °C.

Resistance to cold: to about minus 40 °C\*.

### Resistant to

Alkalis, most acids, alcohol.

### Conditionally resistant to

Oils and greases.

### Unstable with

Butyric acid, concentrated nitric acid, concentrated acetic acid,  
acetone, ether, petrol and benzene, solvents for paints and lacquers,  
chlorine, diesel fuel.

### Risk of tension cracking

Relatively high.

Stress cracks can be caused by, amongst other things, acetone, ether,  
petrol, cyclohexane, heptane, methanol, propanol and the softeners  
used in some PVC cable mixes.

\*The minus values apply only for parts in the quiescent condition with  
no severe impact stress.

There is no plastic that is resistant to every chemical. The agents listed  
are only a small selection. Plastic parts are especially at risk in the  
presence of chemicals and high temperatures. Stress cracks may  
occur. If in doubt, please consult us and/or ask for a detailed chemical  
resistance table.

Stress crack formation: stress cracks may occur if plastic parts under  
tension are exposed to chemicals at the same time. Parts made of  
polystyrene and polyethylene are particularly susceptible. Stress cracks  
may even be caused by agents to which the plastic in question is  
resistant in the absence of stress. Typical examples of parts under  
constant stress when used as intended: grip clips, intermediate  
supports of cable glands, ribbon clips.



# Tested lightning protection components

## Tightening torques

M5 = 4 Nm

M6 = 6 Nm

M8 = 12 Nm

M10 = 20 Nm

Detailed data can be provided on request.

# Brief glossary of overvoltage protection

## 100% response lightning impulse voltage

The 100% response lightning impulse voltage is the value of the lightning impulse voltage 1.2/50  $\mu$ s, causing the arrester to switch. With this testing voltage, the surge protection device must respond ten times to ten loads.

## Arrestor

Arrestors are resources, which primarily consist of voltage-dependent resistors and/or spark gaps. Both elements can be switched in series or in parallel or used individually.

Arrestors are used to protect other electrical resources and electrical systems against surge voltages.

## Arrestor measured voltage $V_c$

For arrestors without a spark gap, the measured voltage is the maximum permitted effective value of the mains voltage on the arrester terminals. The measured voltage may constantly be applied to the arrester without changing its operational characteristics.

## Back-up fuse before the arrestors

There must be a back-up fuse before the arrestors. If the upstream fuse is greater than the maximum approved back-up fuse of the arrester elements (see technical data of the device), the arrester must be protected selectively with the required value.

## Cut-off unit

The cut-off unit cuts the arrester off from the mains or the earthing system if it is overloaded, thus preventing a fire risk and also signalling the switch-off of the protection device.

## Equipotential bonding

Electrical connection, which brings the bodies of electrical resources and other conductive parts to the same or almost the same potential.

## Equipotential bonding rail (PAS)

A terminal or rail, intended to connect the protective conductor, the equipotential bonding conductor and, if necessary, the conductor for function earthing with the earthing cable and the earthers.

## Error current protection unit (RCD)

Resource for protection against electric shocks and fire protection (e.g. FI protection switches).

## Lightning protection equipotential bonding system

The lightning protection equipotential bonding is a key measure in reducing the risk of fire and explosion on the room or building to be protected. The lightning protection equipotential bonding is achieved using equipotential bonding cables or arrestors, which connect the external lightning protection system, metallic parts of the building or room, the installation, the other conductive parts and the electrical energy and telecommunications systems.

## Lightning protection system (LPS)

A lightning protection system (LPS) is considered as the entire system used to protect a room or building against the impact of a lightning strike. This includes both internal and external lightning protection.

## Lightning protection zone (LPZ)

Lightning protection zones are those areas in which the electromagnetic environment of the lightning is to be defined and mastered. At the zone transitions, all cables and metallic parts must be integrated into the equipotential bonding system.

## Lightning surge current (Iimp)

A lightning surge current (lightning current carrying capacity per path) is a standardised surge current curve of the shape 10/350  $\mu$ s. With its parameters

- Peak value
- Charge
- Specific energy

it represents the load from natural lightning currents. Type 1 lightning current arrestors (previously requirement class B) must be able to arrest such lightning currents without being destroyed.

## Line follow current quenching (If)

The follow current – also called network follow current – is the current which flows through the surge protection device after an arresting operation and is supplied by the network. The follow current is considerably different from the continuous operating current. The level of the network follow current is dependent on the feed line from the transformer to the arrester.

## Nominal current (In)

The nominal current is the maximum permitted operating current which may be run continually through the appropriately labelled connection terminals.

## Nominal discharge surge current (In)

Peak value of the current flowing through the arrester with the wave shape 8/20. It is used to classify the testing of surge arrestors of type 2 (formerly requirements Class C).

## Nominal frequency (fn)

The nominal frequency is that frequency for which a resource is measured, by which it is called and upon which other nominal parameters refer.

## Nominal voltage (Vn)

The rated voltage is the voltage value for which a resource is designed. In so doing it might be a direct voltage value or the effective value of a sine-form alternating voltage.

## Surge protection device (ÜSG)

A device intended for the limitation of transient surge voltages and arresting of surge voltages. It contains at least one non-linear construction element. In general speech, surge protection devices are also termed arrestors.

## Protection level (Up)

The protection level is the highest current voltage value on the terminals of the surge protection device before response.

## Residual voltage (Vres)

The peak voltage value, occurring via the terminals of the surge protection device during or immediately after the arresting surge current has flowed.

## Short-circuit resistance

The surge protection device must be able to conduct the short-circuit current, until it is either interrupted by the device itself or by an internal or external cut-off unit or by mains-side over-current protection (e.g. back-up fuse).

## Response time (ta)

The response time primarily characterises the response behaviour of the individual protection elements used in arrestors. Depending on the slope  $du/dt$  of the surge voltage or  $di/dt$  of the surge current, the response times may vary within specific limits.

## SPD

Surge protection device.

## Surge arrester, type 1

Arrestors, which, due to their special structure, are able to arrest lightning currents or partial lightning currents during direct strikes.

## Surge arrester, type 2

Arrestors, which are able to arrest surge voltages caused by remote or nearby strikes or switching actions.

## Surge arrester, type 3

Arrestors, used for surge protection of individual consumers or consumer groups and are employed directly on sockets.

## Surge voltage

A surge voltage is a voltage occurring briefly between conductors or between a conductor and the earth, which exceeds the highest permissible operating voltage value by a long way, but does not have the operating frequency. It can be created by storms or by earthing or short-circuits.

## Temperature range

The operating temperature specifies within which temperature limits the perfect function of the surge protection device is guaranteed.

## Transient surge voltage (TOV)

Temporary surge voltages are short-term (i.e. temporary) surge voltages, which may occur due to errors within the medium and low-voltage network.

## Transmission frequency (fg)

The transmission frequency specifies up to which frequency the insertion damping of the employed resource is less than 3 dB.

## Volume resistance per path, series resistance

The volume resistance per path specifies the ohmic resistance increase of the conductor path per wire caused by the use of the surge protection device.



## Conversion table, cable material

Conversion table, cable material

Designation	Item number	Weight approx. (kg/m)	Weight approx. (kg/100 m)	Length approx. (m/kg)
Flat conductor St/FT, 20x2.5	5019340	0.41	41	2.44
Flat conductor St/FT, 25x3	5019342	0.60	59.7	1.68
Flat conductor St/FT, 30x3	5019344	0.71	70.65	1.42
Flat conductor St/FT, 30x3.5	5019345/5019347	0.84	84	1.19
Flat conductor St/FT, 30x4	5019350	0.97	97	1.03
Flat conductor St/FT, 40x4	5019355	1.28	128	0.78
Flat conductor St/FT, 40x5	5019360	1.62	162	0.62
Flat conductor copper, 20x2.5	5021804	0.45	44.5	2.25
Flat conductor VA, 30x3.5	5018501 (V2A) 5018706 (V4A) 5018730 (V4A)	0.83	82.5	1.21
St/FT round cable, 8 mm	5021081	0.40	40	2.50
St/FT round cable, 10 mm	5021103	0.63	63	1.59
Aluminium round cable, 8 mm	5021286 5021294	0.14	13.5	7.41
Aluminium round cable, 10 mm	5021308	0.21	21	4.76
Copper round cable, 8 mm	5021480	0.45	45	2.22
Copper round cable, 10 mm	5021502	0.70	70	1.43
VA round cable, 8 mm	5021235 (V2A) 5021644 (V4A)	0.40	40	2.50
VA round cable, 10 mm	5021227 (V2A) 5021239 (V2A) 5021642 (V4A) 5021647 (V4A)	0.63	63	1.59
St/FT round cable with PVC jacket, 10 mm	5021162	0.67	67.2	1.49
Aluminium round cable with PVC jacket, 8 mm	5021332	0.20	20	5.00
Copper cable, 9 mm	5021650	0.45	44.5	2.25
Copper cable, 10.5 mm	5021654	0.59	58.6	1.71















## Surge protection energy technology, arrester, type 1+2 (office and housing)

	Combination arrester	V50, 280 V	148
	Accessories, upper parts and bases V50		151
	Combination arrester	V25, 150 V	154
		V25, 280 V	156
		V25, 385 V	161
	Accessories, upper parts and bases V25		163
	Combination arrester, protection set for TN and TT network systems		167





## Surge protection energy technology: the plus of the V50+B+C family

- + Connectable lightning current and surge arrestor
- + High arresting capacity up to 50 kA (10/350)
- + Combination arrestor for buildings with lightning protection
- + Visual status display
- + Available with optional remote signalling
- + Vibration-proof through Shock Guard
- + Simple standard hat rail mounting
- + Labelled connections
- + Usable in systems with lightning protection class 3



### Function and areas of use

The combination lightning and surge arrestors V50 meet the type 1 requirement class according to IEC 61643-11. These devices protect low voltage consumer systems from overvoltages of all

types, and are available in single-pole to four-pole versions. The voltage-limiting high-performance zinc oxide varistor provides several benefits. An extremely short response time, a low protection level and high current leakage capability with long service life. In addition,

the devices do not produce any line follow current. If circumstances are uncertain and there is a risk of fire from overloads, the cut-off unit disconnects the arrestor safely from the mains.



# Combination arrester V50, 280 V for TN and TT network systems



- Combination arrester, lightning current and surge arrester, type 1+2
- For lightning protection equipotential bonding to VDE 0185-305 (IEC 62305)
  - Lightning current arresting capacity 12.5 kA (10/350) per pole and up to 50 kA (10/350) in total
  - Arrester, plug-in, with dynamic cut-off unit and visual function display
  - Encapsulated, non-extinguishing zinc oxide varistor arrester for use in distributor housings

Application: Residential building with external lightning protection of Class III and IV.



## Lightning current and surge arrester, 1-pole + NPE

Type	Max. continuous operating voltage V	Version	Pack. pcs	Weight kg/100 pcs.	Item No.
<b>V50-B+C 1+NPE</b>	280	1 + NPE	1	31.300	<b>5093 65 3</b>

/pc.

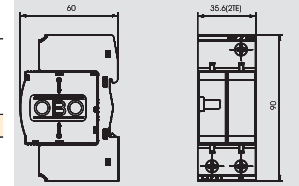

## Lightning current and surge arrester, 2-pole + NPE

Type	Max. continuous operating voltage V	Version	Pack. pcs	Weight kg/100 pcs.	Item No.
<b>V50-B+C 2+NPE</b>	280	2 + NPE	1	32.000	<b>5093 65 5</b>

/pc.

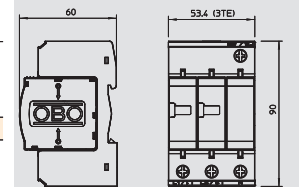

## Lightning current and surge arrester, 3-pole + NPE

Type	Max. continuous operating voltage V	Version	Pack. pcs	Weight kg/100 pcs.	Item No.
<b>V50-B+C 3+NPE</b>	280	3+NPE	1	55.000	<b>5093 65 4</b>

/pc.

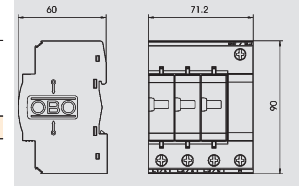

V50-B+C 1+NPE

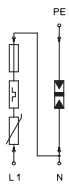

V50-B+C 2+NPE

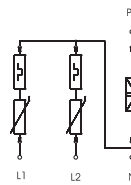

V50-B+C 3+NPE

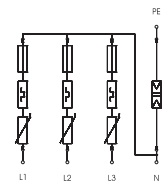

Nominal voltage	$U_N$	V	230	230	230
SPD to EN 61643-11			Type 1+2	Type 1+2	Type 1+2
SPD to IEC 61643-11			class I+II	class I+II	class I+II
Lightning protection Zone LPZ			0→2	0→2	0→2
Impulse discharge current (10/350)	$I_{imp}$	kA	12,5	12,5	12,5
Total discharge current (10/350)	$I_{Total}$	kA	25	25	50
Nominal discharge current (8/20)	$I_n$	kA	30	30	30
Total discharge current (8/20)	$I_{Total}$	kA	50	50	50
Maximum discharge current	$I_{max}$	kA	50	50	50
Voltage protection level	$U_p$	kV	< 1,3	< 1,3	< 1,3
Response time	$t_A$	ns	<25	<25	<25
Maximum back-up fuse		A	125	125	125
Temperature range	$\vartheta$	°C	-40 - +80	-40 - +80	-40 - +80
Division unit TE (17.5 mm)			2	3	4
Degree of protection of enclosure			IP20	IP20	IP20
Connection cross-section, rigid		mm <sup>2</sup>	2,5 - 35	2,5 - 35	2,5 - 35
Connection cross-section, multi-wire		mm <sup>2</sup>	2,5 - 35	2,5 - 35	2,5 - 35
Connection cross-section, flexible		mm <sup>2</sup>	2,5 - 25	2,5 - 25	2,5 - 25
<b>Item No.</b>			<b>5093 65 3</b>	<b>5093 65 5</b>	<b>5093 65 4</b>



# Combination arrester V50, 280 V for TN and TT network systems

Combination arrester, lightning current and surge arrester, type 1+2

- For lightning protection equipotential bonding to VDE 0185-305 (IEC 62305)
- Lightning current arresting capacity 12.5 kA (10/350) per pole and up to 50 kA (10/350) in total
- Arrester, plug-in, with dynamic cut-off unit and visual function display
- Encapsulated, non-extinguishing zinc oxide varistor arrester for use in distributor housings



Application: Residential building with external lightning protection of Class III and IV.

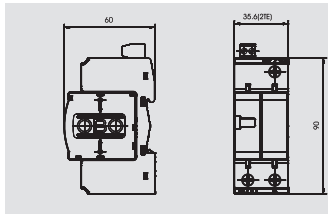

## Lightning current and surge arrester, 1-pole + NPE with remote signalling

Type	Max. continuous operating voltage V	Version	Pack. pcs	Weight kg/100 pcs.	Item No.
V50-B+C 1+NPE+FS	280	1+NPE with FS	1	26.100	5093 66 1

/pc.

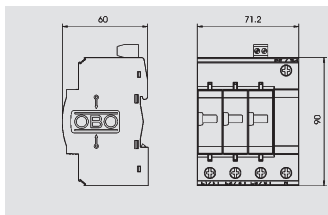

## Lightning current and surge arrester, 3-pole + NPE with remote signalling

Type	Max. continuous operating voltage V	Version	Pack. pcs	Weight kg/100 pcs.	Item No.
V50-B+C 3+NPE+FS	280	3+NPE with FS	1	55.000	5093 66 2

/pc.



Surge protection, arrester, type 1+2 (office and housing)



V50-B+C 1+NPE+FS

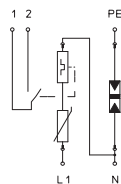

V50-B+C 3+NPE+FS

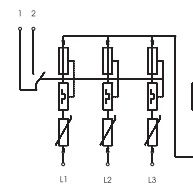

Nominal voltage	$U_N$	V	230	230
SPD to EN 61643-11			Type 1+2	Type 1+2
SPD to IEC 61643-11			class I+II	class I+II
Lightning protection Zone LPZ			0-2	0-2
Impulse discharge current (10/350)	$I_{imp}$	kA	12,5	12,5
Total discharge current (10/350)	$I_{Total}$	kA	25	50
Nominal discharge current (8/20)	$I_n$	kA	30	30
Total discharge current (8/20)	$I_{Total}$	kA	50	50
Maximum discharge current	$I_{max}$	kA	50	50
Voltage protection level	$U_p$	kV	< 1,3	< 1,3
Response time	$t_A$	ns	<25	<25
Maximum back-up fuse		A	125	125
Temperature range	$\vartheta$	°C	-40 - +80	-40 - +80
Division unit TE (17,5 mm)			2	4
Degree of protection of enclosure			IP20	IP20
Connection cross-section, rigid		mm <sup>2</sup>	2,5 - 35	2,5 - 35
Connection cross-section, multi-wire		mm <sup>2</sup>	2,5 - 35	2,5 - 35
Connection cross-section, flexible		mm <sup>2</sup>	2,5 - 25	2,5 - 25
<b>Item No.</b>			<b>5093 66 1</b>	<b>5093 66 2</b>

# Combination arrester V50, 280 V for TN-C network systems



- Combination arrester, lightning current and surge arrester, type 1+2
- For lightning protection equipotential bonding to VDE 0185-305 (IEC 62305)
  - Lightning current arresting capacity 12.5 kA (10/350) per pole and up to 50 kA (10/350) in total
  - Arrester, plug-in, with dynamic cut-off unit and visual function display
  - Encapsulated, non-extinguishing zinc oxide varistor arrester for use in distributor housings

Application: Residential building with external lightning protection of Class III and IV.



## Lightning current and surge arrester, 3-pole

Type	Max. continuous operating voltage V	Version	Pack. pcs	Weight kg/100 pcs.	Item No.
<b>V50-B+C 3-280</b>	280	3-pole	1	42.300	<b>5093 62 7</b>

/pc.

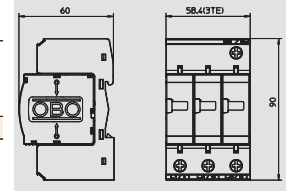

## Lightning current and surge arrester, 3-pole with remote signalling

Type	Max. continuous operating voltage V	Version	Pack. pcs	Weight kg/100 pcs.	Item No.
<b>V50-B+C 3+FS280</b>	280	3-pole with FS	1	43.000	<b>5093 64 3</b>

/pc.

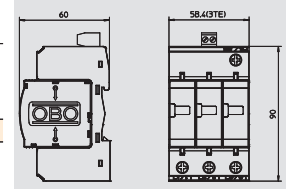

## Lightning current and surge arrester, 4-pole

Type	Max. continuous operating voltage V	Version	Pack. pcs	Weight kg/100 pcs.	Item No.
<b>V50-B+C 4</b>	280	4-pole	1	53.000	<b>5093 63 1</b>

/pc.

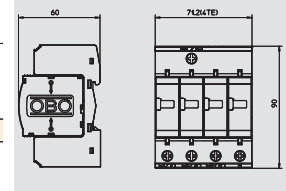

## Lightning current and surge arrester, 4-pole with remote signalling

Type	Max. continuous operating voltage V	Version	Pack. pcs	Weight kg/100 pcs.	Item No.
<b>V50-B+C 4+FS</b>	280	4-pole with FS	1	53.200	<b>5093 64 7</b>

/pc.

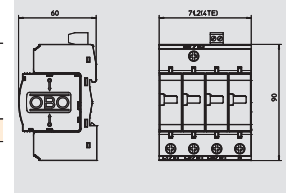

V50-B+C 3-280

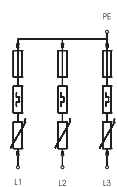

V50-B+C 3+FS280

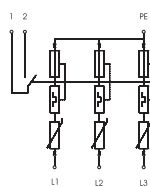

V50-B+C 4

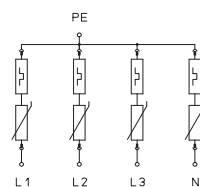

V50-B+C 4+FS

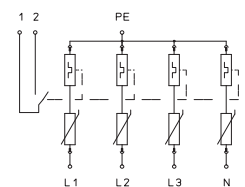

Nominal voltage	$U_N$	V	230	230	230	230
SPD to EN 61643-11			Type 1+2	Type 1+2	Type 1+2	Type 1+2
SPD to IEC 61643-11			class I+II	class I+II	class I+II	class I+II
Lightning protection Zone LPZ			0-2	0-2	0-2	0-2
Impulse discharge current (10/350)	$I_{imp}$	kA	12,5	12,5	12,5	12,5
Total discharge current (10/350)	$I_{Total}$	kA	37,5	37,5	50	50
Nominal discharge current (8/20)	$I_n$	kA	30	30	30	30
Total discharge current (8/20)	$I_{Total}$	kA	90	90	120	120
Maximum discharge current	$I_{max}$	kA	50	50	50	50
Voltage protection level	$U_p$	kV	< 1,3	< 1,3	< 1,3	< 1,3
Response time	$t_A$	ns	<25	<25	<25	<25
Maximum back-up fuse		A	125	125	125	125
Temperature range	$\vartheta$	°C	-40 - +80	-40 - +80	-40 - +80	-40 - +80
Division unit TE (17.5 mm)			3	3	4	4
Degree of protection of enclosure			IP20	IP20	IP20	IP20
Connection cross-section, rigid		mm <sup>2</sup>	2,5 - 35	2,5 - 35	2,5 - 35	2,5 - 35
Connection cross-section, multi-wire		mm <sup>2</sup>	2,5 - 35	2,5 - 35	2,5 - 35	2,5 - 35
Connection cross-section, flexible		mm <sup>2</sup>	2,5 - 25	2,5 - 25	2,5 - 25	2,5 - 25
<b>Item No.</b>			<b>5093 62 7</b>	<b>5093 64 3</b>	<b>5093 63 1</b>	<b>5093 64 7</b>

V 50-B+C/0...: CombiController, upper part – Type 1+2 CombiArrestor



- Plug-in upper part; upper part can be separated from base without tools and current cut-off in bottom part
- Including thermal and dynamic separating device and visual fault display
- High current conductivity and long service life

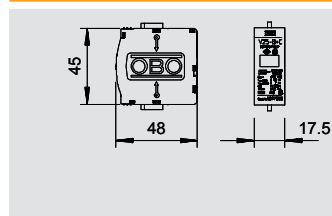

## Combination arrestor upper part 150 V

Type	Max. continuous operating voltage V	U max DC V	Version	Pack. pcs	Weight kg/100 pcs.	Item No.
<b>V 50-B+C 0-150</b>	150	200	1-pole upper part	1	6.500	<b>5094 40 0</b>

/pc.

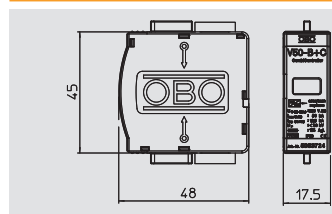

## Combination arrestor upper part 280 V

Type	Max. continuous operating voltage V	U max DC V	Version	Pack. pcs	Weight kg/100 pcs.	Item No.
<b>V50-B+C 0-280</b>	280	350	1-pole upper part	1	8.000	<b>5093 72 4</b>

/pc.



Surge protection, arrestor, type 1+2 (office and housing)



02\_TBS\_Masterkatalog\_Länder\_2012 / en / 29/05/2012 (LLEExport\_01433) / 29/05/2012

V 50-B+C 0-150

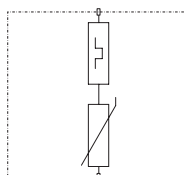

V50-B+C 0-280

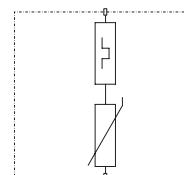

	$U_N$	V	150	230
Nominal voltage			150	230
SPD to EN 61643-11			Type 1+2	Type 1+2
SPD to IEC 61643-11			class I+II	class I+II
Lightning protection Zone LPZ			0-2	0-2
Impulse discharge current (10/350)	$I_{imp}$	kA	12,5	12,5
Total discharge current (10/350)	$I_{Total}$	kA	12,5	12,5
Nominal discharge current (8/20)	$I_n$	kA	30	30
Total discharge current (8/20)	$I_{Total}$	kA	30	30
Maximum discharge current	$I_{max}$	kA	50	50
Voltage protection level	$U_p$	kV	< 1,0	< 1,3
Response time	$t_A$	ns	<25	<25
Maximum back-up fuse		A	125	125
Temperature range	$\vartheta$	°C	-40 - +80	-40 - +80
Division unit TE (17,5 mm)			1	1
Degree of protection of enclosure			IP20	IP20
<b>Item No.</b>			<b>5094 40 0</b>	<b>5093 72 4</b>

## Accessories, upper parts and bases V50



MB...: Base for V 50-B+C, combination arrester, lightning and surge voltage arrester type 1+2 according to DIN EN 61643-11 (B+C according to VDE 0675 part 6).

- Also suitable for V 25-B+C, V 20-C and V10-C
- Pre-mounted and ready for connection
- Multifunction terminals for easy connection to series-mounted devices
- Upper part can be rotated through 180 degrees
- 3+1 protection circuit for TN-S and TT network systems

Application: lightning protection equipotential bonding for buildings also with external lightning protection of Classes III and IV and in standard distributor housings.



### CombiController V50 base

Type	Max. continuous operating voltage V	Version	Pack. pcs	Weight kg/100 pcs.	Item No.
<b>MB 50-3+NPE</b>	280	3+NPE base	1	27.000	<b>5096 67 5</b>

/pc.

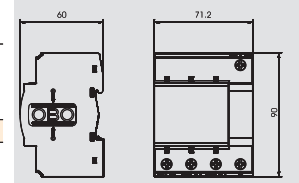

### CombiController V50 base with remote signalling

Type	Max. continuous operating voltage V	Version	Pack. pcs	Weight kg/100 pcs.	Item No.
<b>MB 50-3+NPE+FS</b>	280	3+NPE with FS	1	29.000	<b>5096 67 7</b>

/pc.

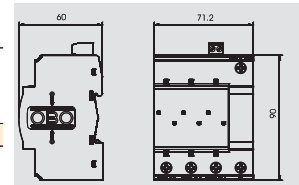

MB 50-3+NPE

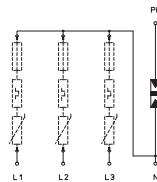

MB 50-3+NPE+FS

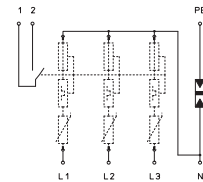

Nominal voltage	$U_N$	V	230	
SPD to EN 61643-11			Type 1+2	
SPD to IEC 61643-11			class I+II	
Lightning protection Zone LPZ			0-2	
Total discharge current (10/350)	$I_{Total}$	kA	50	
Voltage protection level	$U_p$	kV	< 1,3	
Response time	$t_A$	ns	<25	
Maximum back-up fuse		A	125	
Temperature range	$\vartheta$	°C	-40 - +80	
Degree of protection of enclosure			IP20	
Division unit TE (17.5 mm)			4	
Connection cross-section, rigid		mm <sup>2</sup>	2,5 - 35	
Connection cross-section, multi-wire		mm <sup>2</sup>	2,5 - 35	
Connection cross-section, flexible		mm <sup>2</sup>	2,5 - 25	
<b>Item No.</b>			<b>5096 67 5</b>	<b>5096 67 7</b>

## Surge protection energy technology: the plus of the V25-B+C family

- + Connectable lightning current and surge arrestor
- + High arresting capacity
- + Combination arrestor for buildings with lightning protection
- + Visual status display
- + Available with optional remote signalling
- + Vibration-proof through Shock Guard
- + Simple standard hat rail mounting
- + Labelled connections



### Function and areas of use

The surge arrestors V25 meet the type 1+2 requirement class according to IEC 61643-11. These devices protect low voltage consumer systems from overvoltages of all types, and are available in

single-pole to four-pole versions. The voltage-limiting high-performance zinc oxide varistor provides several benefits. An extremely short response time, a low protection level and high current leakage capability with long service life. In

addition, the devices do not produce any line follow current. If circumstances are uncertain and there is a risk of fire from overloads, the cut-off unit disconnects the arrestor safely from the mains.



# Combination arrester V25, 150 V for TN and TT network systems



- Combination arrester, lightning current and surge arrester, type 1+2
- For lightning protection equipotential bonding to VDE 0185-305 (IEC 62305)
  - Lightning current arresting capacity 7 kA (10/350) per pole and up to 25 kA (10/350) in total
  - Arrester, plug-in, with dynamic cut-off unit and visual function display
  - Encapsulated, non-extinguishing zinc oxide varistor arrester for use in distributor housings

Application: Building with outdoor line infeed or lightning risk.



## Combination arrester, 1-pole + NPE

Type	Max. continuous operating voltage V	Version	Pack. pcs	Weight kg/100 pcs.	Item No.
<b>V25-B+C 1NPE150</b>	150	1+NPE	1	24.900	<b>5094 44 8</b>

/pc.

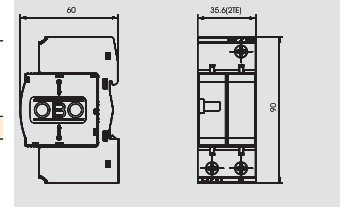

## Combination arrester, 3-pole + NPE

Type	Max. continuous operating voltage V	Version	Pack. pcs	Weight kg/100 pcs.	Item No.
<b>V25-B+C 3NPE150</b>	150	3+NPE	1	45.900	<b>5094 45 4</b>

/pc.

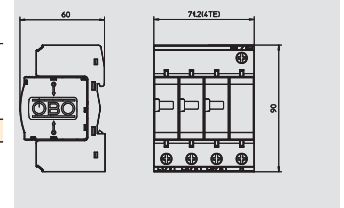

V25-B+C 1NPE150



V25-B+C 3NPE150

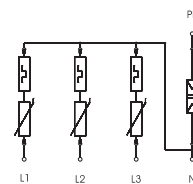

Nominal voltage	$U_N$	V	130	130
SPD to EN 61643-11			Type 1+2	Type 1+2
SPD to IEC 61643-11			class I+II	class I+II
Lightning protection Zone LPZ			0-2	0-2
Impulse discharge current (10/350)	$I_{imp}$	kA	8	8
Total discharge current (10/350)	$I_{Total}$	kA	16	25
Nominal discharge current (8/20)	$I_n$	kA	30	30
Total discharge current (8/20)	$I_{Total}$	kA	60	120
Maximum discharge current	$I_{max}$	kA	50	50
Voltage protection level	$U_p$	kV	<0,6	<0,6
Response time	$t_A$	ns	< 25	< 25
Maximum back-up fuse		A	160	160
Temperature range	$\vartheta$	°C	-40 - +80	-40 - +80
Division unit TE (17.5 mm)			2	4
Degree of protection of enclosure			IP20	IP20
Connection cross-section, rigid		mm <sup>2</sup>	2,5 - 35	2,5 - 35
Connection cross-section, multi-wire		mm <sup>2</sup>	2,5 - 35	2,5 - 35
Connection cross-section, flexible		mm <sup>2</sup>	2,5 - 25	2,5 - 25
<b>Item No.</b>			<b>5094 44 8</b>	<b>5094 45 4</b>



# Combination arrester V25, 150 V

Combination arrester, lightning current and surge arrester, type 1+2

- For lightning protection equipotential bonding to VDE 0185-305 (IEC 62305)
- Lightning current arresting capacity 7 kA (10/350) per pole and up to 25 kA (10/350) in total
- Arrester, plug-in, with dynamic cut-off unit and visual function display
- Encapsulated, non-extinguishing zinc oxide varistor arrester for use in distributor housings



Application: Building with outdoor line infeed or lightning risk.

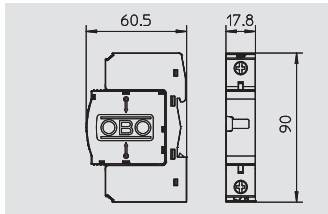

## Combination arrester, 1-pole

Type	Max. continuous operating voltage V	Version	Pack. pcs	Weight kg/100 pcs.	Item No.
<b>V25-B+C 1-150</b>	150	1-pole	1	13.500	<b>5094 40 1</b>

/pc.

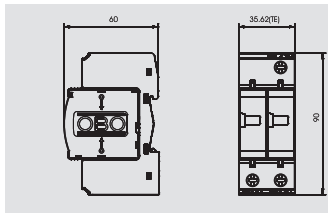

## Combination arrester, 2-pole

Type	Max. continuous operating voltage V	Version	Pack. pcs	Weight kg/100 pcs.	Item No.
<b>V25-B+C 2-150</b>	150	1-pole	1	25.500	<b>5094 40 3</b>

/pc.



V25-B+C 1-150

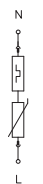

V25-B+C 2-150

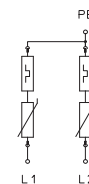

Nominal voltage	$U_N$	V	130	130
SPD to EN 61643-11			Type 1+2	Type 1+2
SPD to IEC 61643-11			class I+II	class I+II
Lightning protection Zone LPZ			0-2	0-2
Impulse discharge current (10/350)	$I_{imp}$	kA	8	25
Total discharge current (10/350)	$I_{Total}$	kA	8	16
Nominal discharge current (8/20)	$I_n$	kA	30	30
Total discharge current (8/20)	$I_{Total}$	kA	30	60
Maximum discharge current	$I_{max}$	kA	50	50
Voltage protection level	$U_p$	kV	<0,6	<0,6
Response time	$t_A$	ns	< 25	< 25
Maximum back-up fuse		A	160	160
Temperature range	$\vartheta$	°C	-40 - +80	-40 - +80
Division unit TE (17,5 mm)			1	2
Degree of protection of enclosure			IP20	IP20
Connection cross-section, rigid		mm <sup>2</sup>	2,5 - 35	2,5 - 35
Connection cross-section, multi-wire		mm <sup>2</sup>	2,5 - 35	2,5 - 35
Connection cross-section, flexible		mm <sup>2</sup>	2,5 - 25	2,5 - 25
<b>Item No.</b>			<b>5094 40 1</b>	<b>5094 40 3</b>



# Combination arrester V25, 280 V for TN and TT network systems

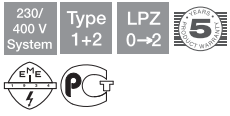

- Combination arrester, lightning current and surge arrester, type 1+2
- For lightning protection equipotential bonding to VDE 0185-305 (IEC 62305)
  - Lightning current arresting capacity 7 kA (10/350) per pole and up to 25 kA (10/350) in total
  - Arrester, plug-in, with dynamic cut-off unit and visual function display
  - Encapsulated, non-extinguishing zinc oxide varistor arrester for use in distributor housings

Application: Building with outdoor line infeed or lightning risk.

## Combination arrester, 1-pole + NPE



Type	Max. continuous operating voltage V	Version	Pack. pcs	Weight kg/100 pcs.	Item No.
<b>V25-B+C 1+NPE</b>	280	1-pole complete with NPE	1	28.000	<b>5094 45 7</b>

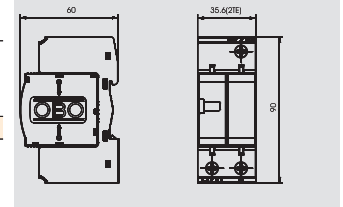

/pc.

## Combination arrester, 2-pole + NPE



Type	Max. continuous operating voltage V	Version	Pack. pcs	Weight kg/100 pcs.	Item No.
<b>V25-B+C 2+NPE</b>	280	2-pole complete with NPE	1	37.000	<b>5094 46 0</b>

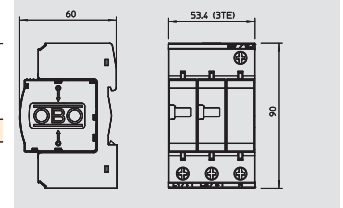

/pc.

## Combination arrester, 3-pole + NPE



Type	Max. continuous operating voltage V	Version	Pack. pcs	Weight kg/100 pcs.	Item No.
<b>V25-B+C 3+NPE</b>	280	3-pole complete with NPE	1	51.000	<b>5094 46 3</b>

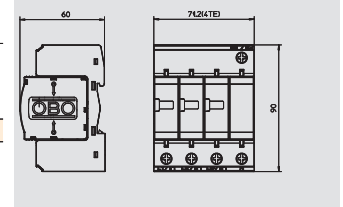

/pc.

## Combination arrester, 1-pole NPE



Type	Max. continuous operating voltage V	Version	Pack. pcs	Weight kg/100 pcs.	Item No.
<b>C 25-B+C 1</b>	255	NPE	1	12.500	<b>5095 60 6</b>

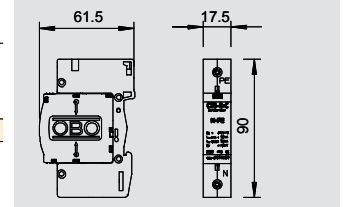

/pc.

V25-B+C 1+NPE

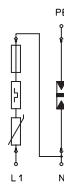

V25-B+C 2+NPE

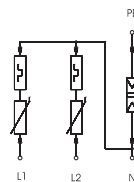

V25-B+C 3+NPE

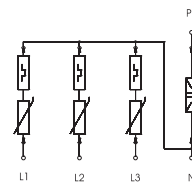

C 25-B+C 1

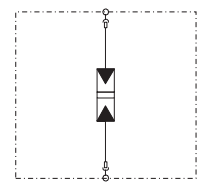

Nominal voltage	$U_N$	V	230	230	230	230
SPD to EN 61643-11			Type 1+2	Type 1+2	Type 1+2	Type 1+2
SPD to IEC 61643-11			class I+II	class I+II	class I+II	class I+II
Lightning protection Zone LPZ			0→2	0→2	0→2	0→2
Impulse discharge current (10/350)	$I_{imp}$	kA	7	7	7	
Total discharge current (10/350)	$I_{Total}$	kA	14	21	25	
Nominal discharge current (8/20)	$I_n$	kA	30	30	30	30
Total discharge current (8/20)	$I_{Total}$	kA	60	90	120	
Maximum discharge current	$I_{max}$	kA	50	50	50	
Voltage protection level	$U_p$	kV	< 0,9	< 0,9	< 0,9	< 1,2
Response time	$t_A$	ns	< 25	< 25	< 25	< 100
Maximum back-up fuse		A	160	160	160	
Temperature range	$\theta$	°C	-40 - +80	-40 - +80	-40 - +80	-40 - +80
Division unit TE (17.5 mm)			2	3	4	1
Degree of protection of enclosure			IP20	IP20	IP20	IP20
Connection cross-section, rigid		mm <sup>2</sup>	2,5 - 35	2,5 - 35	2,5 - 35	2,5 - 35
Connection cross-section, multi-wire		mm <sup>2</sup>	2,5 - 35	2,5 - 35	2,5 - 35	2,5 - 35
Connection cross-section, flexible		mm <sup>2</sup>	2,5 - 25	2,5 - 25	2,5 - 25	2,5 - 25
Lightning impulse current (10/350) (N-PE)	$I_{imp}$	kA				25
Follow current interrupt rating	$I_c$	kA				0.1
<b>Item No.</b>			<b>5094 45 7</b>	<b>5094 46 0</b>	<b>5094 46 3</b>	<b>5095 60 6</b>

# Combination arrester V25, 280 V for TN and TT network systems, with remote signalling

- Combination arrester, lightning current and surge arrester, type 1+2
- For lightning protection equipotential bonding to VDE 0185-305 (IEC 62305)
- Lightning current arresting capacity 7 kA (10/350) per pole and up to 25 kA (10/350) in total
- Arrester, plug-in, with dynamic cut-off unit and visual function display
- Encapsulated, non-extinguishing zinc oxide varistor arrester for use in distributor housings



Application: Building with outdoor line infeed or lightning risk.

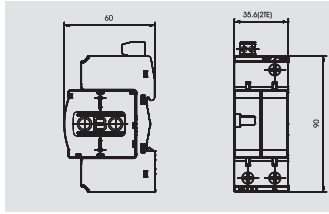

## Combination arrester, 1-pole + NPE with remote signalling

Type	Max. continuous operating voltage V	Version	Pack. pcs	Weight kg/100 pcs.	Item No.
V25-B+C 1+NPE+FS	280	1+NPE with FS	1	27.500	5094 44 4

/pc.

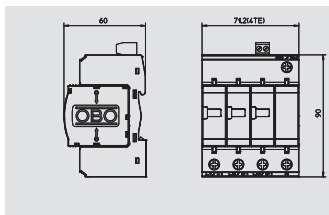

## Combination arrester, 3-pole + NPE with remote signalling

Type	Max. continuous operating voltage V	Version	Pack. pcs	Weight kg/100 pcs.	Item No.
V25-B+C 3+NPE-FS	280	3+NPE with FS	1	52.500	5094 51 0

/pc.

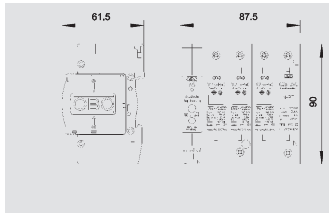

## Combination arrester, 3-pole + NPE, with acoustic signalling

Type	Max. continuous operating voltage V	Version	Pack. pcs	Weight kg/100 pcs.	Item No.
V25-B+C 3+NPE+AS	280	3 + NPE	1	70.000	5097 43 2

/pc.



V25-B+C 1+NPE+FS

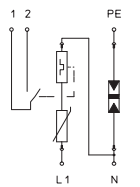

V25-B+C 3+NPE-FS

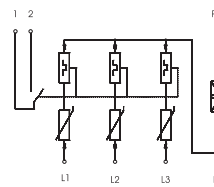

V25-B+C 3+NPE+AS

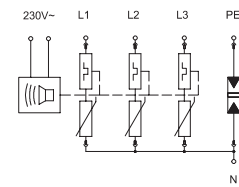

Nominal voltage	$U_N$	V	230	230	230
SPD to EN 61643-11			Type 1+2	Type 1+2	Type 1+2
SPD to IEC 61643-11			class I+II	class I+II	class I+II
Lightning protection Zone LPZ			0-2	0-2	0-2
Impulse discharge current (10/350)	$I_{imp}$	kA	7	7	7
Total discharge current (10/350)	$I_{Total}$	kA	14	25	25
Nominal discharge current (8/20)	$I_n$	kA	30	30	30
Total discharge current (8/20)	$I_{Total}$	kA	60	120	120
Maximum discharge current	$I_{max}$	kA	50	150	50
Voltage protection level	$U_p$	kV	< 0,9	< 0,9	< 0,9
Response time	$t_A$	ns	< 25	< 25	< 25
Maximum back-up fuse		A	160	160	160
Temperature range	$\vartheta$	°C	-40 - +80	-40 - +80	-40 - +80
Division unit TE (17,5 mm)			2	3	5
Degree of protection of enclosure			IP20	IP20	IP20
Connection cross-section, rigid		mm <sup>2</sup>	2,5 - 35	2,5 - 35	2,5 - 35
Connection cross-section, multi-wire		mm <sup>2</sup>	2,5 - 35	2,5 - 35	2,5 - 35
Connection cross-section, flexible		mm <sup>2</sup>	2,5 - 25	2,5 - 25	2,5 - 25
<b>Item No.</b>			<b>5094 44 4</b>	<b>5094 51 0</b>	<b>5097 43 2</b>



# Combination arrester V25, 280 V



- Combination arrester, lightning current and surge arrester, type 1+2
- For lightning protection equipotential bonding to VDE 0185-305 (IEC 62305)
  - Lightning current arresting capacity 7 kA (10/350) per pole and up to 25 kA (10/350) in total
  - Arrester, plug-in, with dynamic cut-off unit and visual function display
  - Encapsulated, non-extinguishing zinc oxide varistor arrester for use in distributor housings

Application: Building with outdoor line infeed or lightning risk.



## Combination arrester, 1-pole

Type	Max. continuous operating voltage V	Version	Pack. pcs	Weight kg/100 pcs.	Item No.
<b>V25-B+C 1-280</b>	280	1-pole	1	15.300	<b>5094 41 8</b>

/pc.

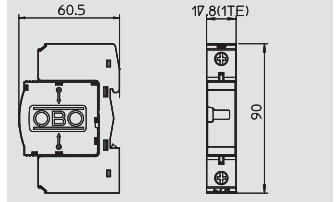

## Combination arrester, 2-pole

Type	Max. continuous operating voltage V	Version	Pack. pcs	Weight kg/100 pcs.	Item No.
<b>V25-B+C 2-280</b>	280	2-pole	1	28.500	<b>5094 42 1</b>

/pc.

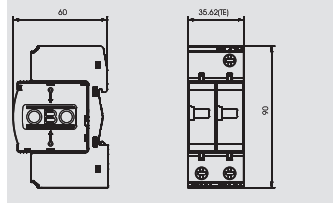

## Combination arrester, 3-pole

Type	Max. continuous operating voltage V	Version	Pack. pcs	Weight kg/100 pcs.	Item No.
<b>V25-B+C 3-280</b>	280	3-pole	1	42.500	<b>5094 42 3</b>

/pc.

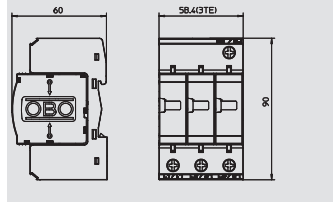

## Combination arrester, 4-pole

Type	Max. continuous operating voltage V	Version	Pack. pcs	Weight kg/100 pcs.	Item No.
<b>V25-B+C 4-280</b>	280	4-pole	1	53.000	<b>5094 42 6</b>

/pc.

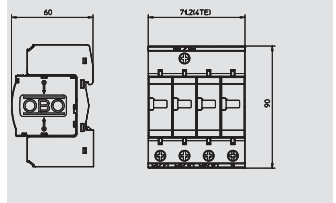

V25-B+C 1-280



V25-B+C 2-280

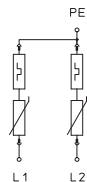

V25-B+C 3-280

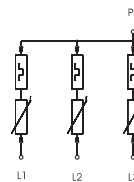

V25-B+C 4-280

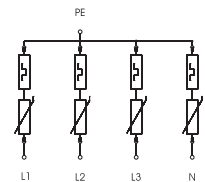

Nominal voltage	$U_N$	V	230	230	230	230
SPD to EN 61643-11			Type 1+2	Type 1+2	Type 1+2	Type 1+2
SPD to IEC 61643-11			class I+II	class I+II	class I+II	class I+II
Lightning protection Zone LPZ			0-2	0-2	0-2	0-2
Impulse discharge current (10/350)	$I_{imp}$	kA	7	7	7	7
Total discharge current (10/350)	$I_{Total}$	kA	7	14	21	25
Nominal discharge current (8/20)	$I_n$	kA	30	30	30	30
Total discharge current (8/20)	$I_{Total}$	kA	30	60	90	120
Maximum discharge current	$I_{max}$	kA	50	50	50	50
Voltage protection level	$U_p$	kV	< 0,9	< 0,9	< 0,9	< 0,9
Response time	$t_A$	ns	< 25	< 25	< 25	< 25
Maximum back-up fuse		A	160	160	160	160
Temperature range	$\vartheta$	°C	-40 - +80	-40 - +80	-40 - +80	-40 - +80
Division unit TE (17.5 mm)			1	2	3	4
Degree of protection of enclosure			IP20	IP20	IP20	IP20
Connection cross-section, rigid		mm <sup>2</sup>	2,5 - 35	2,5 - 35	2,5 - 35	2,5 - 35
Connection cross-section, multi-wire		mm <sup>2</sup>	2,5 - 35	2,5 - 35	2,5 - 35	2,5 - 35
Connection cross-section, flexible		mm <sup>2</sup>	2,5 - 25	2,5 - 25	2,5 - 25	2,5 - 25
<b>Item No.</b>			<b>5094 41 8</b>	<b>5094 42 1</b>	<b>5094 42 3</b>	<b>5094 42 6</b>

# Combination arrester V25, 280 V with remote signalling

- Combination arrester, lightning current and surge arrester, type 1+2
- For lightning protection equipotential bonding to VDE 0185-305 (IEC 62305)
- Lightning current arresting capacity 7 kA (10/350) per pole and up to 25 kA (10/350) in total
- Arrester, plug-in, with dynamic cut-off unit and visual function display
- Encapsulated, non-extinguishing zinc oxide varistor arrester for use in distributor housings



Application: Building with outdoor line infeed or lightning risk.

## Combination arrester, 3-pole with remote signalling

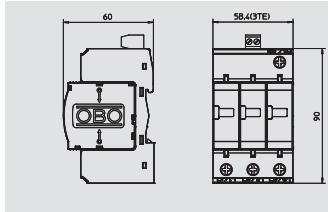

Type	Max. continuous operating voltage V	Version	Pack. pcs	Weight kg/100 pcs.	Item No.
V25-B+C 3-FS280	280	3-pole with FS	1	42.700	5094 49 0

/pc.



## Combination arrester, 4-pole with remote signalling

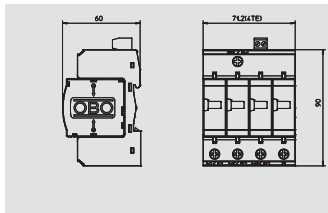

Type	Max. continuous operating voltage V	Version	Pack. pcs	Weight kg/100 pcs.	Item No.
V25-B+C 4-FS280	280	4-pole with FS	1	53.200	5094 49 3

/pc.



## Combination arrester, 3-pole, with acoustic signalling

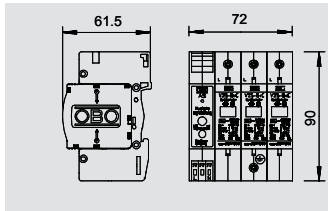

Type	Max. continuous operating voltage V	Version	Pack. pcs	Weight kg/100 pcs.	Item No.
V25-B+C 3+AS	280	3-pole	1	50.500	5097 18 5

/pc.



## Combination arrester, 4-pole, with acoustic signalling

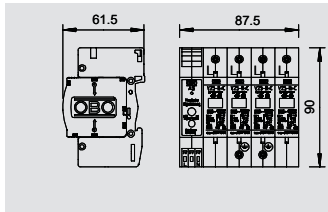

Type	Max. continuous operating voltage V	Version	Pack. pcs	Weight kg/100 pcs.	Item No.
V25-B+C 4+AS280	280	4-pole	1	70.000	5097 19 3

/pc.

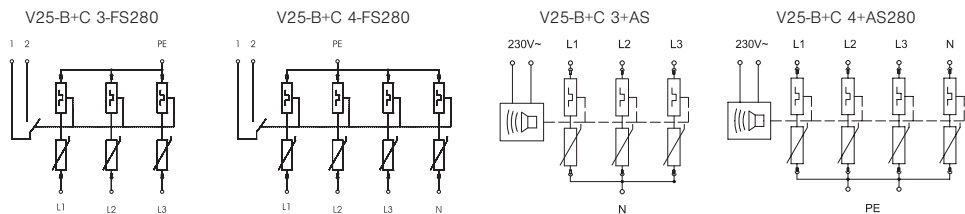

	$U_N$	V	230	230	230	230
Nominal voltage			230	230	230	230
SPD to EN 61643-11			Type 1+2	Type 1+2	Type 1+2	Type 1+2
SPD to IEC 61643-11			class I+II	class I+II	class I+II	class I+II
Lightning protection Zone LPZ			0-2	0-2	0-2	0-2
Impulse discharge current (10/350)	$I_{imp}$	kA	7	7	7	7
Total discharge current (10/350)	$I_{Total}$	kA	21	25	21	25
Nominal discharge current (8/20)	$I_n$	kA	30	30	30	30
Total discharge current (8/20)	$I_{Total}$	kA	90	120	90	120
Maximum discharge current	$I_{max}$	kA	50	50	50	50
Voltage protection level	$U_p$	kV	< 0,9	< 0,9	< 0,9	< 0,9
Response time	$t_A$	ns	< 25	< 25	< 25	< 25
Maximum back-up fuse	A	A	160	160	160	160
Temperature range	$\vartheta$	°C	-40 - +80	-40 - +80	-40 - +80	-40 - +80
Division unit TE (17,5 mm)			3	4	4	5
Degree of protection of enclosure			IP20	IP20	IP20	IP20
Connection cross-section, rigid	mm <sup>2</sup>		2,5 - 35	2,5 - 35	2,5 - 35	2,5 - 35
Connection cross-section, multi-wire	mm <sup>2</sup>		2,5 - 35	2,5 - 35	2,5 - 35	2,5 - 35
Connection cross-section, flexible	mm <sup>2</sup>		2,5 - 25	2,5 - 25	2,5 - 25	2,5 - 25
<b>Item No.</b>			<b>5094 49 0</b>	<b>5094 49 3</b>	<b>5097 18 5</b>	<b>5097 19 3</b>



# Combination arrester V25, 280 V



- Combination arrester, lightning current and surge arrester, type 1+2
- For lightning protection equipotential bonding to VDE 0185-305 (IEC 62305)
  - Lightning current arresting capacity 7 kA (10/350) per pole and up to 25 kA (10/350) in total
  - Arrester, plug-in, with dynamic cut-off unit and visual function display
  - Encapsulated, non-extinguishing zinc oxide varistor arrester for use in distributor housings

Application: Building with outdoor line infeed or lightning risk.

## Combination arrester, 4-pole, with voltage monitoring



Type	Max. continuous operating voltage V	Version	Pack. pcs	Weight kg/100 pcs.	Item No.
V25-B+C 4+FS-SÜ	280	4-pole	1	67.500	5097 35 5

/pc.

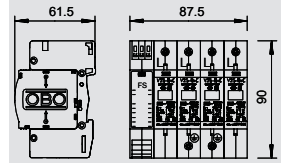

## Combination arrester, 4-pole in housing with remote signalling



Type	Max. continuous operating voltage V	Version	Pack. pcs	Weight kg/100 pcs.	Item No.
V25-B+C 4-FS-G	280	4-pole	1	127.000	5094 55 2

/pc.

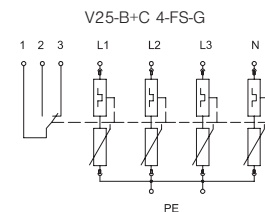
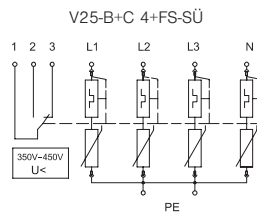
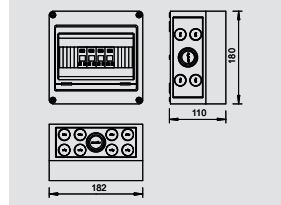

Nominal voltage	$U_N$	V	230	230
SPD to EN 61643-11			Type 1+2	Type 1+2
SPD to IEC 61643-11			class I+II	class I+II
Lightning protection Zone LPZ			0-2	0-2
Impulse discharge current (10/350)	$I_{imp}$	kA	7	7
Total discharge current (10/350)	$I_{Total}$	kA	25	25
Nominal discharge current (8/20)	$I_n$	kA	30	30
Total discharge current (8/20)	$I_{Total}$	kA	120	120
Maximum discharge current	$I_{max}$	kA	50	50
Voltage protection level	$U_p$	kV	< 0,9	< 0,9
Response time	$t_A$	ns	< 25	< 25
Maximum back-up fuse		A	160	160
Temperature range	$\vartheta$	°C	-40 - +80	-40 - +80
Division unit TE (17.5 mm)			5	2
Degree of protection of enclosure			IP20	IP65
Connection cross-section, rigid		mm <sup>2</sup>	2,5 - 35	2,5 - 35
Connection cross-section, multi-wire		mm <sup>2</sup>	2,5 - 35	2,5 - 35
Connection cross-section, flexible		mm <sup>2</sup>	2,5 - 25	2,5 - 25
Follow current interrupt rating	$I_c$	kA		
<b>Item No.</b>			<b>5097 35 5</b>	<b>5094 55 2</b>



# Combination arrester V25, 385 V for TN and TT network systems

- Combination arrester, lightning current and surge arrester, type 1+2
- For lightning protection equipotential bonding to VDE 0185-305 (IEC 62305)
  - Lightning current arresting capacity 7 kA (10/350) per pole and up to 25 kA (10/350) in total
  - Arrester, plug-in, with dynamic cut-off unit and visual function display
  - Encapsulated, non-extinguishing zinc oxide varistor arrester for use in distributor housings

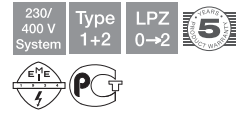

Application: Building with outdoor line infeed or lightning risk.

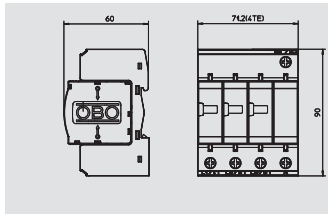

## Combination arrester, 3-pole + NPE

Type	Max. continuous operating voltage V	Version	Pack. pcs	Weight kg/100 pcs.	Item No.
<b>V25-B+C 3NPE385</b>	385	3-pole with NPE; 385 V	1	53.700	<b>5094 47 8</b>

/pc.

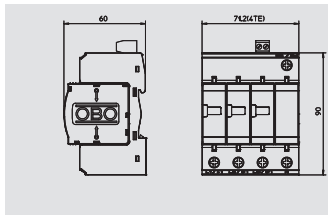

## Combination arrester, 3-pole + NPE with remote signalling

Type	Max. continuous operating voltage V	Version	Pack. pcs	Weight kg/100 pcs.	Item No.
<b>V25-B+C 3NPEFS38</b>	385	3 + NPE	1	51.000	<b>5094 52 6</b>

/pc.

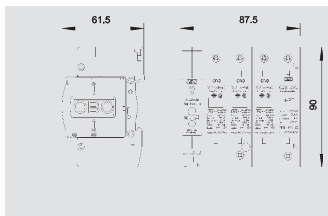

## Combination arrester, 3-pole + NPE, with acoustic signalling

Type	Max. continuous operating voltage V	Version	Pack. pcs	Weight kg/100 pcs.	Item No.
<b>V25-B+C 3NPEAS38</b>	385	3 + NPE	1	60.300	<b>5097 11 1</b>

/pc.



V25-B+C 3NPE385

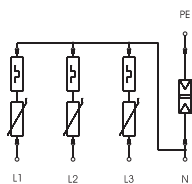

V25-B+C 3NPEFS38

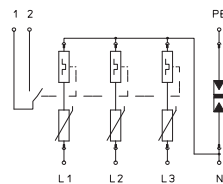

V25-B+C 3NPEAS38

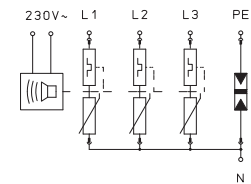

Nominal voltage	$U_N$	V	350	350	350
SPD to EN 61643-11			Type 1+2	Type 1+2	Type 1+2
SPD to IEC 61643-11			class I+II	class I+II	class I+II
Lightning protection Zone LPZ			0-2	0-2	0-2
Impulse discharge current (10/350)	$I_{imp}$	kA	7	7	7
Total discharge current (10/350)	$I_{Total}$	kA	25	25	25
Nominal discharge current (8/20)	$I_n$	kA	30	30	30
Total discharge current (8/20)	$I_{Total}$	kA	120	120	120
Maximum discharge current	$I_{max}$	kA	50	50	50
Voltage protection level	$U_p$	kV	< 1,5	< 1,5	< 1,5
Response time	$t_A$	ns	< 25	< 25	< 25
Maximum back-up fuse		A	160	160	160
Temperature range	$\vartheta$	°C	-40 - +80	-40 - +80	-40 - +80
Division unit TE (17,5 mm)			4	4	
Degree of protection of enclosure			IP20	IP20	IP20
Connection cross-section, rigid		mm <sup>2</sup>	2,5 - 35	2,5 - 35	2,5 - 35
Connection cross-section, multi-wire		mm <sup>2</sup>	2,5 - 35	2,5 - 35	2,5 - 35
Connection cross-section, flexible		mm <sup>2</sup>	2,5 - 25	2,5 - 25	2,5 - 25
<b>Item No.</b>			<b>5094 47 8</b>	<b>5094 52 6</b>	<b>5097 11 1</b>



# Combination arrester V25, 385 V



- Combination arrester, lightning current and surge arrester, type 1+2
- For lightning protection equipotential bonding to VDE 0185-305 (IEC 62305)
  - Lightning current arresting capacity 7 kA (10/350) per pole and up to 25 kA (10/350) in total
  - Arrester, plug-in, with dynamic cut-off unit and visual function display
  - Encapsulated, non-extinguishing zinc oxide varistor arrester for use in distributor housings

Application: Building with outdoor line infeed or lightning risk.

## Combination arrester, 1-pole



Type	Max. continuous operating voltage V	Version	Pack. pcs	Weight kg/100 pcs.	Item No.
<b>V25-B+C 1-385</b>	385	1-pole complete	1	14.500	<b>5094 43 1</b>

/pc.

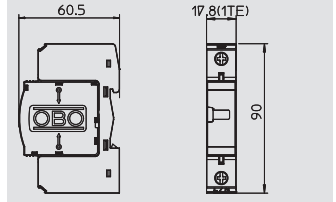

## Combination arrester, 2-pole



Type	Max. continuous operating voltage V	Version	Pack. pcs	Weight kg/100 pcs.	Item No.
<b>V25-B+C 2-385</b>	385	2-pole complete	1	27.500	<b>5094 43 4</b>

/pc.

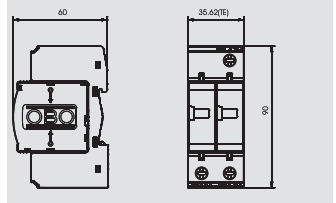

## Combination arrester, 3-pole



Type	Max. continuous operating voltage V	Version	Pack. pcs	Weight kg/100 pcs.	Item No.
<b>V25-B+C 3-385</b>	385	3-pole complete	1	42.000	<b>5094 43 7</b>

/pc.

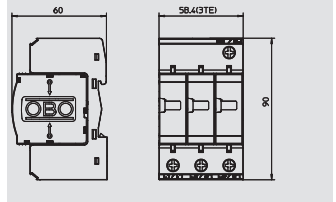

## Combination arrester, 4-pole



Type	Max. continuous operating voltage V	Version	Pack. pcs	Weight kg/100 pcs.	Item No.
<b>V25-B+C 4-385</b>	385	4-pole complete	1	51.000	<b>5094 44 0</b>

/pc.

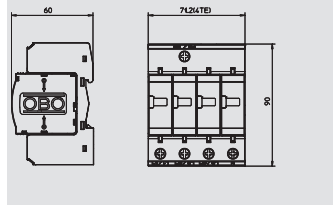

V25-B+C 1-385



V25-B+C 2-385

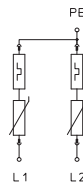

V25-B+C 3-385

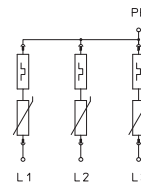

V25-B+C 4-385

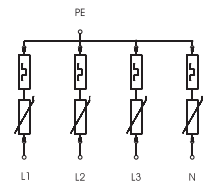

	$U_N$	V	350	350	350	350
Nominal voltage						
SPD to EN 61643-11			Type 1+2	Type 1+2	Type 1+2	Type 1+2
SPD to IEC 61643-11			class I+II	class I+II	class I+II	class I+II
Lightning protection Zone LPZ			0-2	0-2	0-2	0-2
Impulse discharge current (10/350)	$I_{imp}$	kA	7	7	7	7
Total discharge current (10/350)	$I_{Total}$	kA	7	14	21	25
Nominal discharge current (8/20)	$I_n$	kA	30	30	30	30
Total discharge current (8/20)	$I_{Total}$	kA	30	60	90	120
Maximum discharge current	$I_{max}$	kA	50	50	50	50
Voltage protection level	$U_p$	kV	< 1,5	< 1,5	< 1,5	< 1,5
Response time	$t_A$	ns	< 25	< 25	< 25	< 25
Maximum back-up fuse		A	160	160	160	160
Temperature range	$\vartheta$	°C	-40 - +80	-40 - +80	-40 - +80	-40 - +80
Division unit TE (17.5 mm)			1	2	3	4
Degree of protection of enclosure			IP20	IP20	IP20	IP20
Connection cross-section, rigid		mm <sup>2</sup>	2,5 - 35	2,5 - 35	2,5 - 35	2,5 - 35
Connection cross-section, multi-wire		mm <sup>2</sup>	2,5 - 35	2,5 - 35	2,5 - 35	2,5 - 35
Connection cross-section, flexible		mm <sup>2</sup>	2,5 - 25	2,5 - 25	2,5 - 25	2,5 - 25
<b>Item No.</b>			<b>5094 43 1</b>	<b>5094 43 4</b>	<b>5094 43 7</b>	<b>5094 44 0</b>

# Accessories, upper parts and bases V25

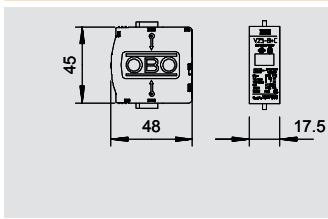

## Combination arrester upper part 150 V

Type	Max. continuous operating voltage V	U max DC V	Version	Pack. pcs	Weight kg/100 pcs.	Item No.
<b>V25-B+C 0-150</b>	150	200	1-pole	1	9.500	<b>5097 08 8</b>

/pc.

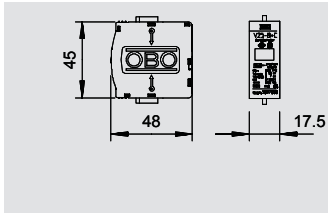

## Combination arrester upper part 280 V

Type	Max. continuous operating voltage V	U max DC V	Version	Pack. pcs	Weight kg/100 pcs.	Item No.
<b>V25-B+C 0-280</b>	280	350	1-pole	1	9.500	<b>5097 05 3</b>

/pc.

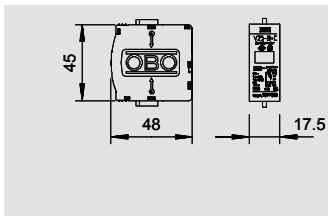

## Combination arrester upper part 320 V

Type	Max. continuous operating voltage V	U max DC V	Version	Pack. pcs	Weight kg/100 pcs.	Item No.
<b>V25-B+C 0-320</b>	320	420	1-pole	100	10.000	<b>5097 29 0</b>

/pc.

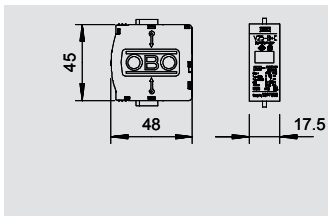

## Combination arrester upper part 385 V

Type	Max. continuous operating voltage V	U max DC V	Version	Pack. pcs	Weight kg/100 pcs.	Item No.
<b>V25-B+C 0-385</b>	385	505	1-pole	1	9.500	<b>5097 06 1</b>

/pc.



02\_TBS\_Masterkatalog\_Länder\_2012 / en / 29/05/2012 (LLEExport\_014333) / 29/05/2012

V25-B+C 0-150

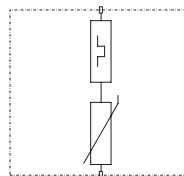

V25-B+C 0-280

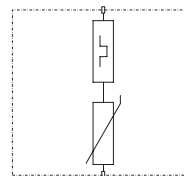

V25-B+C 0-320

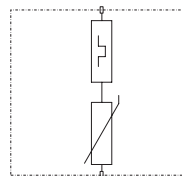

V25-B+C 0-385

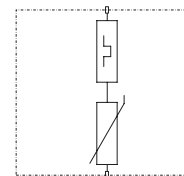

	$U_N$	V	130	230	320	350
Nominal voltage			130	230	320	350
SPD to EN 61643-11			Type 1+2	Type 1+2	Type 1+2	Type 1+2
SPD to IEC 61643-11			class I+II	class I+II	class I+II	class I+II
Lightning protection Zone LPZ			0-2	0-2	0-2	0-2
Impulse discharge current (10/350)	$I_{imp}$	kA	8	7	7	7
Total discharge current (10/350)	$I_{Total}$	kA	8	7	7	7
Nominal discharge current (8/20)	$I_n$	kA	30	30	30	30
Total discharge current (8/20)	$I_{Total}$	kA	30	30	30	30
Maximum discharge current	$I_p$	kA	50	50	50	50
Voltage protection level	$U_p^{max}$	kV	< 0,6	< 0,9	< 1,3	< 1,5
Response time	$t_A$	ns	< 25	< 25	< 25	< 25
Maximum back-up fuse		A	160	160	160	160
Temperature range	$\vartheta$	°C	-40 - +80	-40 - +80	-40 - +80	-40 - +80
Division unit TE (17,5 mm)			1	1	1	1
Degree of protection of enclosure			IP20	IP20	IP20	IP20
<b>Item No.</b>			<b>5097 08 8</b>	<b>5097 05 3</b>	<b>5097 29 0</b>	<b>5097 06 1</b>

Always indicate the item number when ordering.



## Accessories, upper parts and bases V25



### Shock Guard for Multibase base

Type	Colour	Version	Pack.	Weight	Item No.
<b>MB-SG</b>	Blue	Locking system for upper parts	100 pcs	0.060 kg/100 pcs.	<b>5096 69 5</b>
PA Polyamide /pc.					

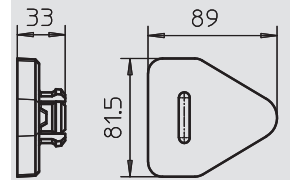

### Connecting bridge, Multibase base

Type	Version	Pack.	Weight	Item No.
<b>VB-MULTIBASE250</b>	4-pole	1 pcs	6.800 kg/100 pcs.	<b>5089 65 5</b>
/pc.				

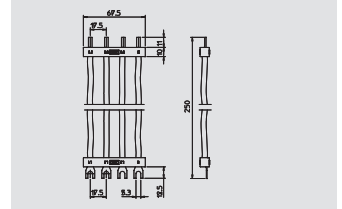

### Empty housing for arrestors

Type	Pack.	Weight	Item No.
<b>VG LM</b>	1 pcs	139.100 kg/100 pcs.	<b>5088 87 9</b>
PA Polyamide /pc.			

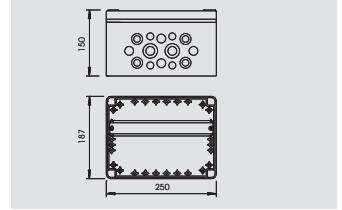

### Upper part total spark gap between N and PE 255 V

Type	Max. continuous operating voltage V	Version	Pack.	Weight	Item No.
<b>C 25-B+C 0</b>	255	NPE	1 pcs	5.200 kg/100 pcs.	<b>5095 60 3</b>
/pc.					

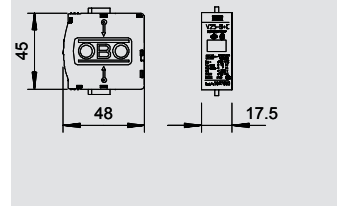

### Remote signalling replacement connector for Multibase

Type	Version	Pack.	Weight	Item No.
<b>MB-FS</b>	2-pole	25 pcs	0.310 kg/100 pcs.	<b>5096 69 3</b>
/pc.				

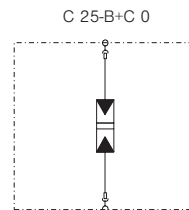
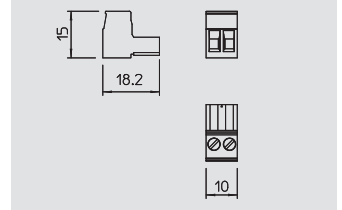

Nominal voltage	$U_N$	V	230
SPD to EN 61643-11			Type 1+2
SPD to IEC 61643-11			class I-II
Lightning protection Zone LPZ			0-2
Lightning impulse current (10/350) (N-PE)	$I_{imp}$	kA	25
Nominal discharge current (8/20)	$I_n$	kA	30
Maximum discharge current	$I_{max}$	kA	50
Voltage protection level	$U_p$	kV	<1,2
Response time	$t_A$	ns	< 100
Follow current interrupt rating	$I_{fi}$	kA	0.1
Maximum back-up fuse		A	160
Temperature range	$\vartheta$	°C	-40 - +80
Division unit TE (17.5 mm)			1
Degree of protection of enclosure			IP20
Connection cross-section, rigid		mm <sup>2</sup>	2,5 - 35
Connection cross-section, multi-wire		mm <sup>2</sup>	2,5 - 35
Connection cross-section, flexible		mm <sup>2</sup>	2,5 - 25
<b>Item No.</b>			<b>5095 60 3</b>

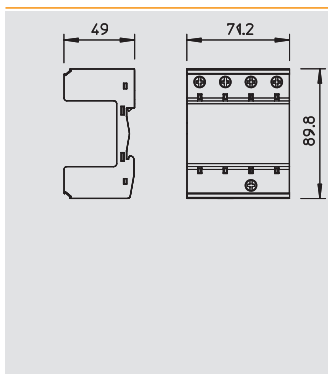

## Base, Multibase



Type	Version	Dividing unit TE (17.5 mm)	Pack.	Weight	Item No.
			pcs	kg/100 pcs.	
<b>MB 1</b>	1-pole	1	1	6.200	<b>5096 64 8</b>
<b>MB 2</b>	2-pole	2	1	11.200	<b>5096 65 3</b>
<b>MB 3</b>	3-pole	3	1	16.000	<b>5096 66 5</b>
<b>MB 4</b>	4-pole	4	1	21.000	<b>5096 68 0</b>



/pc.

- Suitable for V25-B+C, V20-C and V10-C
- Pre-mounted and ready for connection
- For TN systems
- Multifunction terminals for easy circuit of series-mounted devices
- Upper parts can be rotated through 180 degrees

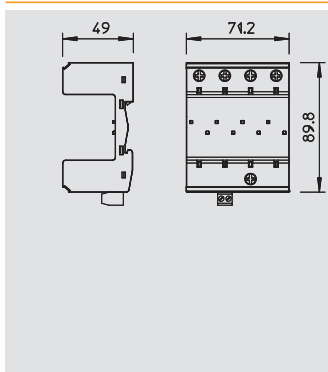

## Base, Multibase with remote signalling



Type	Version	Dividing unit TE (17.5 mm)	Pack.	Weight	Item No.
			pcs	kg/100 pcs.	
<b>MB 1+FS</b>	1-pole	1	1	6.700	<b>5096 64 9</b>
<b>MB 2+FS</b>	2-pole	2	1	11.700	<b>5096 65 4</b>
<b>MB 3+FS</b>	3-pole	3	1	16.500	<b>5096 66 7</b>
<b>MB 4+FS</b>	4-pole	4	1	21.000	<b>5096 68 2</b>



/pc.

- Suitable for V 25-B+C, V 20-C and V10-C
- Pre-mounted and ready for connection
- Multifunction terminals for easy connection to series-mounted devices
- Upper parts can be rotated through 180 degrees
- With remote signalling, potential-free NO contact, for function monitoring

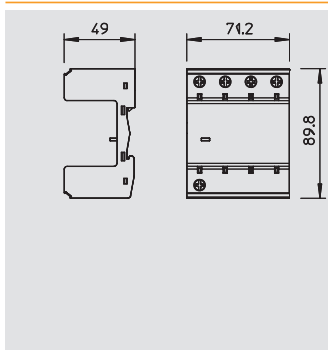

## Base, Multibase + NPE



Type	Version	Dividing unit TE (17.5 mm)	Pack.	Weight	Item No.
			pcs	kg/100 pcs.	
<b>MB 1+NPE</b>	1 + NPE	2	1	11.500	<b>5096 65 0</b>
<b>MB 2+NPE</b>	2 + NPE	3	1	16.100	<b>5096 65 5</b>
<b>MB 3+NPE</b>	3 + NPE	4	1	20.000	<b>5096 66 9</b>



/pc.

- Suitable for V 25-B+C, V 20-C and V10-C
- Pre-mounted and ready for connection
- Multifunction terminals for easy connection to series-mounted devices
- Upper parts can be rotated through 180 degrees
- For TN-S and TT network systems

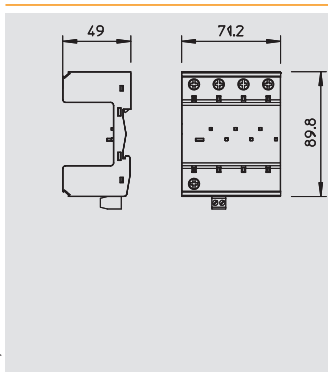

## Base, Multibase + NPE with remote signalling



Type	Version	Dividing unit TE (17.5 mm)	Pack.	Weight	Item No.
			pcs	kg/100 pcs.	
<b>MB 1+NPE+FS</b>	1 + NPE	2	1	11.600	<b>5096 65 1</b>
<b>MB 2+NPE+FS</b>	2 + NPE	3	1	16.000	<b>5096 65 7</b>
<b>MB 3+NPE+FS</b>	3 + NPE	4	1	21.300	<b>5096 67 1</b>



/pc.

- Suitable for V 25-B+C, V 20-C and V10-C
- Pre-mounted and ready for connection
- Multifunction terminals for easy connection to series-mounted devices
- Upper parts can be rotated through 180 degrees
- With remote signalling, potential-free NO contact, for function monitoring
- 3+1 protection circuit for TN-S and TT network systems

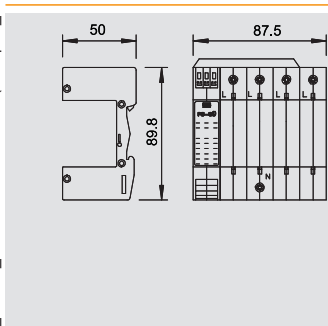

## Base, Multibase with fuse monitoring



Type	Version	Pack.	Weight	Item No.
		pcs	kg/100 pcs.	
<b>V20-C U-3 FS-SU</b>	3-pole	1	26.000	<b>5096 35 9</b>
<b>V20-C U-4 FS-SU</b>	4-pole	1	33.000	<b>5096 36 7</b>



/pc.

- Suitable for V 25-B+C, V 20-C and V 10-C
- With voltage monitoring of phases and function monitoring of arrester upper part, remote signalling
- With remote signaling, potential-free changeover contact, for function monitoring
- Pre-mounted and ready for connection

## Accessories, upper parts and bases V25



### Base, Multibase with acoustic signalling

Type	Version	Pack.	Weight	Item No.
		pcs	kg/100 pcs.	
<b>V20-C U-2 AS</b>	2-pole	1	23.000	<b>5096 41 3</b>
<b>V20-C U-3 AS</b>	3-pole	1	29.000	<b>5096 42 1</b>
<b>V20-C U-4 AS</b>	4-pole	1	35.000	<b>5096 44 8</b>
<b>V20-C U-3+NPE-AS</b>	3 + NPE	1	32.500	<b>5096 37 2</b>

/pc.

- Suitable for V 25-B+C, V 20-C and V 10-C
- With remote signaling, potential-free changeover contact, for function monitoring
- With acoustic signalling for function monitoring, signal tone can be shut down for 24 h
- Pre-mounted and ready for connection

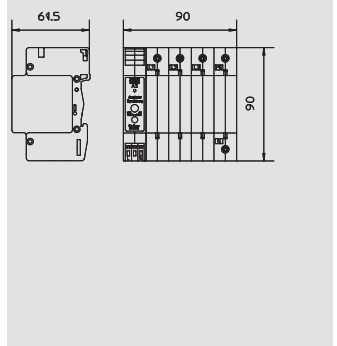

### Base, Multibase + NPE with fuse monitoring

Type	Version	Pack.	Weight	Item No.
		pcs	kg/100 pcs.	
<b>V20-C U-3+NPE</b>	3-NPE with FS-SÜ	1	30.000	<b>5096 37 0</b>

/pc.

- Suitable for V 25-B+C, V 20-C and V 10-C
- With voltage monitoring of phases and function monitoring of arrester upper part, remote signalling
- With remote signalling, potential-free changeover contact, for function monitoring
- For TN-S and TT network systems
- Pre-mounted and ready for connection

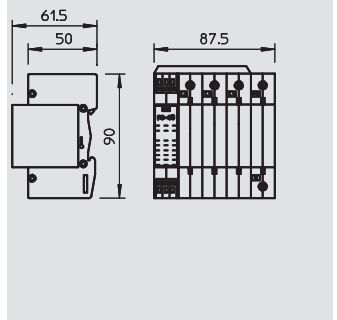



# Combination arrester, protection set for TN and TT network systems

Protection set, lightning and surge arrester combination, Type 1+2

- For lightning protection equipotential bonding to VDE 0185-305 (IEC 62305)
- Lightning current arresting capacity to 50 kA (10/350) per pole and up to 125 kA (10/350) N-PE
- Arrester, connectable, including connecting bridges, labelled connection terminals
- Encapsulated, non-extinguishing arrester for use in distributor housings

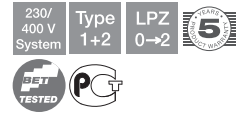

Application: Mobile telecommunications systems and industrial systems with special requirements.

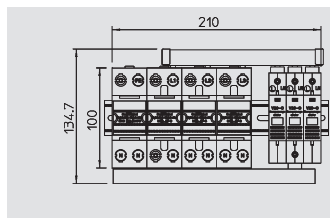

## Protection set MCD + V20 3-pole + NPE

Type	Max. continuous operating voltage V	Version	Pack. pcs	Weight kg/100 pcs.	Item No.
PS4-B+C TT+TNS	255	3 + NPE	1	206.000	5089 76 1

/pc.

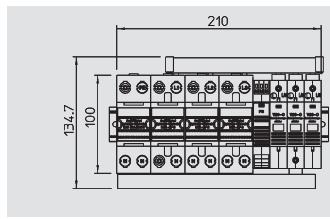

## Protection set MCD + V20 3-pole + NPE with remote signalling

Type	Max. continuous operating voltage V	Version	Pack. pcs	Weight kg/100 pcs.	Item No.
PS4-B+C TNS+FS	255	3 + NPE	1	211.000	5089 76 3

/pc.

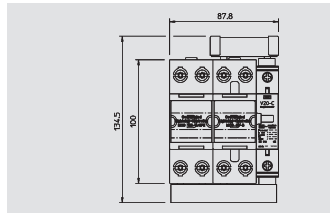

## Protection set MCD + V20 1-pole + NPE

Type	Max. continuous operating voltage V	Version	Pack. pcs	Weight kg/100 pcs.	Item No.
PS 2-B+C/TT+TNS	255	1 + NPE	1	101.000	5089 74 8

/pc.

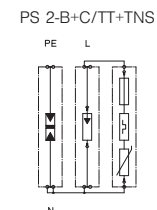
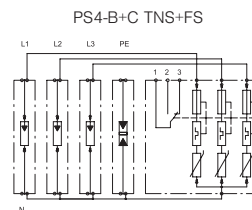
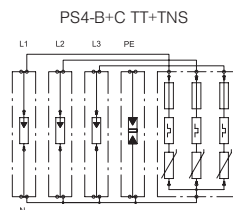

	PS4-B+C TT+TNS	PS4-B+C TNS+FS	PS 2-B+C/TT+TNS
Nominal voltage	230	230	230
SPD to EN 61643-11	Type 1+2	Type 1+2	Type 1+2
SPD to IEC 61643-11	class I+II	class I+II	class I+II
Lightning protection Zone LPZ	0-2	0-2	0-2
Impulse discharge current (10/350)	100	100	100
Total discharge current (10/350)	100	100	100
Nominal discharge current (8/20)	100	100	100
Total discharge current (8/20)	100	100	100
Maximum discharge current	100	100	100
Voltage protection level	<1,3	<1,3	<1,3
Response time	<25	<25	<25
Follow current interrupt rating	25	25	25
Maximum back-up fuse	125	125	125
Temperature range	-40 - +85	-40 - +85	-40 - +85
Division unit TE (17,5 mm)	12	11	5
Degree of protection of enclosure	IP20	IP20	IP20
Connection cross-section, rigid	10 - 50	10 - 50	10 - 50
Connection cross-section, multi-wire	10 - 35	10 - 35	10 - 35
Connection cross-section, flexible	10 - 25	10 - 25	10 - 25
<b>Item No.</b>	<b>5089 76 1</b>	<b>5089 76 3</b>	<b>5089 74 8</b>

Always indicate the item number when ordering.

# Combination arrester, protection set for TN-C network systems

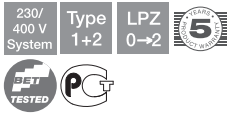

Protection set, lightning and surge arrester combination, Type 1+2

- For lightning protection equipotential bonding to VDE 0185-305 (IEC 62305)
- Lightning current arresting capacity to 50 kA (10/350) per pole and up to 125 kA (10/350) N-PE
- Arrester, connectable, including connecting bridges, labelled connection terminals
- Encapsulated, non-extinguishing arrester for use in distributor housings

Application: Mobile telecommunications systems and industrial systems with special requirements.

## Protection set MCD + V20 3-pole



Type	Max. continuous operating voltage V	Version	Pack. pcs	Weight kg/100 pcs.	Item No.
<b>PS3-B+C TNC</b>	255	3-pole	1	158.000	<b>5089 75 4</b>
<b>PS3-B+C-320</b>	320	3-pole	1	160.000	<b>5089 75 5</b>

/pc.

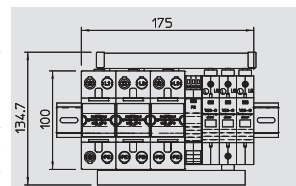

## Protection set MCD + V20 3-pole with remote signalling



Type	Max. continuous operating voltage V	Version	Pack. pcs	Weight kg/100 pcs.	Item No.
<b>PS3-B+C TNC+FS</b>	255	3-pole	1	163.000	<b>5089 75 6</b>

/pc.

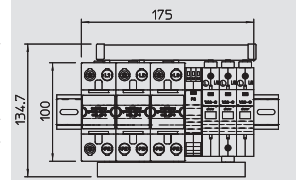

## Protection set MCD + V20 3-pole with remote signalling



Type	Max. continuous operating voltage V	Version	Pack. pcs	Weight kg/100 pcs.	Item No.
<b>PS3-B+C-320+FS</b>	320	3-pole	1	170.000	<b>5089 75 7</b>

/pc.

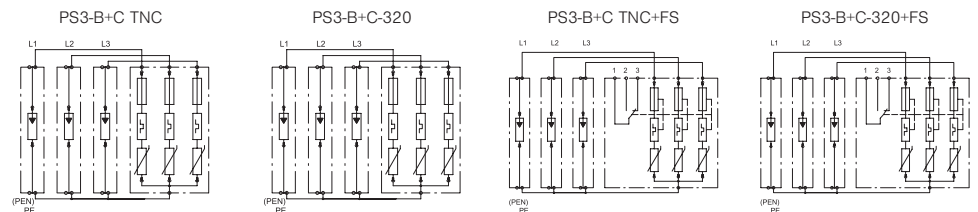
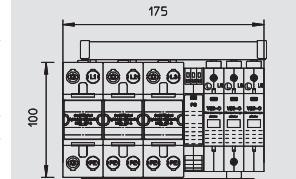

Nominal voltage	$U_N$	V	230	320	230	320
SPD to EN 61643-11			Type 1+2	Type 1+2	Type 1+2	Type 1+2
SPD to IEC 61643-11			class I+II	class I+II	class I+II	class I+II
Lightning protection Zone LPZ			0-2	0-2	0-2	0-2
Impulse discharge current (10/350)	$I_{imp}$	kA	100	100	100	100
Total discharge current (10/350)	$I_{Total}$	kA	100	100	100	100
Nominal discharge current (8/20)	$I_n$	kA	100	100	100	100
Total discharge current (8/20)	$I_{Total}$	kA	100	100	100	100
Maximum discharge current	$I_{max}$	kA	100	100	100	100
Voltage protection level	$U_p$	kV	< 1,3	< 1,7	< 1,3	< 1,7
Response time	$t_A$	ns	< 25	< 25	< 25	< 25
Follow current interrupt rating	$I_{fi}$	kA	25	25	25	25
Maximum back-up fuse		A	125	125	125	125
Temperature range	$\vartheta$	°C	-40 - +85	-40 - +85	-40 - +85	-40 - +85
Division unit TE (17.5 mm)			10	10	10	10
Degree of protection of enclosure			IP20	IP20	IP20	IP20
Connection cross-section, rigid		mm <sup>2</sup>	10 - 50	10 - 50	10 - 50	10 - 50
Connection cross-section, multi-wire		mm <sup>2</sup>	10 - 35	10 - 35	10 - 35	10 - 35
Connection cross-section, flexible		mm <sup>2</sup>	10 - 25	10 - 25	10 - 25	10 - 25
<b>Item No.</b>			<b>5089 75 4</b>	<b>5089 75 5</b>	<b>5089 75 6</b>	<b>5089 75 7</b>

# Combination arrester, protection set VA for TN and TT network systems

Protection set VA, lightning and surge arrester combination, Type 1+2

- For lightning protection equipotential bonding to VDE 0185-305 (IEC 62305)
- Lightning current arresting capacity to 50 kA (10/350) per pole and up to 125 kA (10/350) N-PE
- Free of leak current and suitable for use in pre-meter area according to the VDEW directive
- Arrester, connectable, including connecting bridges, labelled connection terminals
- Encapsulated, non-extinguishing arrester for use in distributor housings

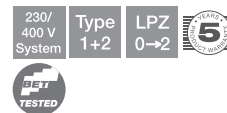

Application: pre-meter area and industrial systems with special requirements.

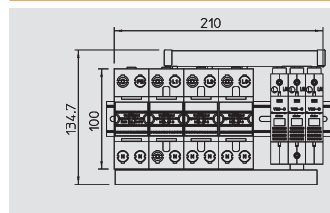

## Protection set MCD + V20, leakage current-free, 3-pole + NPE

Type	Max. continuous operating voltage V	Version	Pack. pcs	Weight kg/100 pcs.	Item No.
<b>PS4-VA TT+TNS</b>	255	3 + NPE	1	210.000	<b>5089 77 0</b>

/pc.

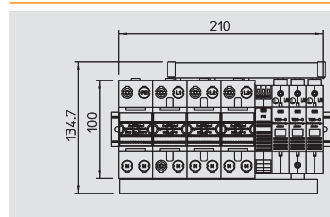

## Protection set MCD + V20, leakage current-free, 3-pole + NPE with remote signalling

Type	Max. continuous operating voltage V	Version	Pack. pcs	Weight kg/100 pcs.	Item No.
<b>PS4-VA TT+FS</b>	255	3 + NPE	1	215.000	<b>5089 77 7</b>

/pc.

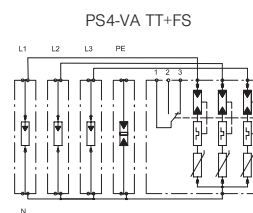
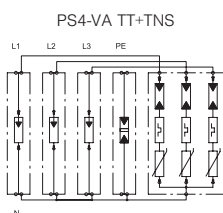



Nominal voltage	$U_N$	V	230	230
SPD to EN 61643-11			Type 1+2	Type 1+2
SPD to IEC 61643-11			class I	class I
Lightning protection Zone LPZ			0→2	0→2
Impulse discharge current (10/350)	$I_{imp}$	kA	100	100
Total discharge current (10/350)	$I_{Total}$	kA	100	100
Nominal discharge current (8/20)	$I_n$	kA	100	100
Total discharge current (8/20)	$I_{Total}$	kA	100	100
Maximum discharge current	$I_{max}$	kA	100	100
Voltage protection level	$U_p$	kV	<1,3	<1,3
Response time	$t_A$	ns	<25	<25
Follow current interrupt rating	$I_{li}$	kA	25	25
Maximum back-up fuse		A	125	125
Temperature range	$\vartheta$	°C	-40 - +85	-40 - +85
Division unit TE (17,5 mm)			12	12
Degree of protection of enclosure			IP20	IP20
Connection cross-section, rigid		mm <sup>2</sup>	10 - 50	10 - 50
Connection cross-section, multi-wire		mm <sup>2</sup>	10 - 35	10 - 35
Connection cross-section, flexible		mm <sup>2</sup>	10 - 25	10 - 25
<b>Item No.</b>			<b>5089 77 0</b>	<b>5089 77 7</b>

Surge protection, arrester, type 1+2 (office and housing)



# Combination arrester, protection set VA for TN-C network systems

230/400 V System  
 Type 1+2  
 LPZ 0→2  
  

Protection set VA, lightning and surge arrester combination, Type 1+2

- For lightning protection equipotential bonding to VDE 0185-305 (IEC 62305)
- Lightning current arresting capacity to 50 kA (10/350) per pole and up to 125 kA (10/350) N-PE
- Free of leak current and suitable for use in pre-meter area according to the VDEW directive
- Arrester, connectable, including connecting bridges, labelled connection terminals
- Encapsulated, non-extinguishing arrester for use in distributor housings

Application: pre-meter area and industrial systems with special requirements.



### Protection set MCD + V20, leakage current-free, 3-pole

Type	Max. continuous operating voltage V	Version	Pack. pcs	Weight kg/100 pcs.	Item No.
<b>PS3-VA TNC</b>	255	3-pole	1	162.000	<b>5089 76 8</b>

/pc.

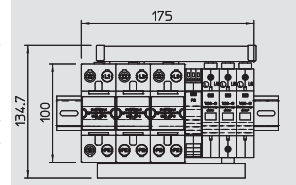

### Protection set MCD + V20, leakage current-free, 3-pole with remote signalling

Type	Max. continuous operating voltage V	Version	Pack. pcs	Weight kg/100 pcs.	Item No.
<b>PS3-VA TNC+FS</b>	255	3-pole	1	167.000	<b>5089 77 5</b>

/pc.

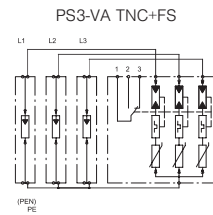
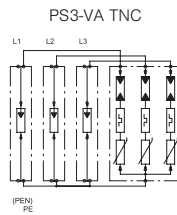
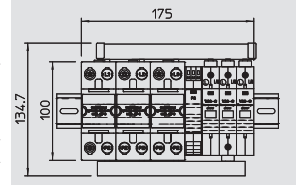



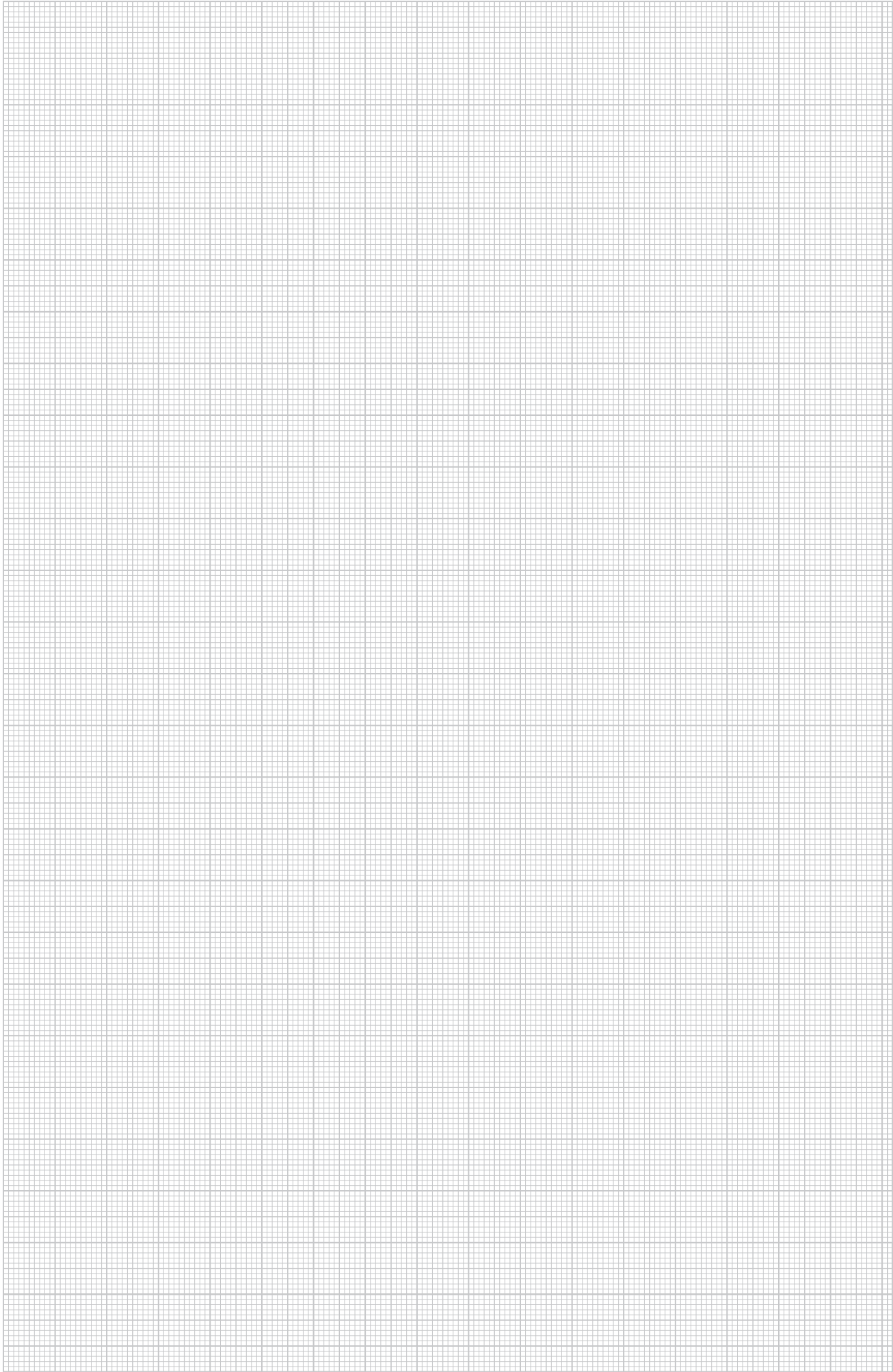

Nominal voltage	$U_N$	V	230	230
SPD to EN 61643-11			Type 1+2	Type 1+2
SPD to IEC 61643-11			class I	class I
Lightning protection Zone LPZ			0→2	0→2
Impulse discharge current (10/350)	$I_{imp}$	kA	100	100
Total discharge current (10/350)	$I_{Total}$	kA	100	100
Nominal discharge current (8/20)	$I_n$	kA	100	100
Total discharge current (8/20)	$I_{Total}$	kA	100	100
Maximum discharge current	$I_{max}$	kA	100	100
Voltage protection level	$U_p$	kV	<1,3	<1,3
Response time	$t_A$	ns	<25	<25
Follow current interrupt rating	$I_{fi}$	kA	25	25
Maximum back-up fuse		A	125	125
Temperature range	$\vartheta$	°C	-40 - +85	-40 - +85
Division unit TE (17.5 mm)			10	10
Degree of protection of enclosure			IP20	IP20
Connection cross-section, rigid		mm <sup>2</sup>	10 - 50	10 - 50
Connection cross-section, multi-wire		mm <sup>2</sup>	10 - 35	10 - 35
Connection cross-section, flexible		mm <sup>2</sup>	10 - 25	10 - 25
<b>Item No.</b>			<b>5089 76 8</b>	<b>5089 77 5</b>





## Directories

	Alphabetical table of contents	398
	Numeric directory	404
	Type listing	408
	Terms and conditions of sale and delivery	419





# Alphabetical table of contents

## A

Accessories for series terminal, 280  
Adapter for flat roof cable holder, 390  
Adjustable insulating beam – pipe, 386  
Adjustable insulating beam – wall, 386  
Angler spreading anchor, 378  
Articulated connector, 384

## B

Base for FangFix Junior, 332  
Base for FangFix system 10 kg, 334, 385  
Base for FangFix system 16 kg, 333, 384  
Base for FangFix system 16 kg for mounting the, 338, 392  
isFang tripod  
Base plate, 351  
Base, Multibase, 165, 196, 205  
Base, Multibase + NPE, 165, 196, 205  
Base, Multibase + NPE with fuse monitoring, 166, 197, 206  
Base, Multibase + NPE with remote signalling, 165, 196, 205  
Base, Multibase with acoustic signalling, 166, 197, 206  
Base, Multibase with fuse monitoring, 165, 196, 205  
Base, Multibase with remote signalling, 165, 196, 205  
Basic protection for 4-wire information technology, 252  
systems with RJ45  
Basic protection for two-core systems with HF, 265  
applications 120 V  
Bi-metal roof gutter clamp for all bead thicknesses, 366  
Bi-metal separating piece for Rd 8–10 and FL 30 mm, 373  
Bi-metal separating piece for Rd 8–10 and FL 30–40, 374  
mm  
Bonding base, 348  
Bonding base including industrial bonding pad, 348  
BP earthing rod, 312  
BP earthing rod with copper sheath, 313  
Bridging cable, 369

## C

Cable bracket for flat conductor, 324  
Cable bracket for Rd 8–10 and FL 30, 324  
Cable bracket with crossbar FL 30 mm, with round, 350  
pin  
Cable bracket with crossbar FL, 30 mm mounting, 350  
height  
Cable bracket with crossbar Rd 8–10 mm, 349  
Cable bracket with crossbar Rd 8–10 mm, with, 350  
square pin  
Cable bracket with crossbar Rd 8–10 mm, with wood, 351  
screw thread  
Cable bracket with hinged crossbar Rd 8–10 mm, 349  
Cable bracket with hinged crossbar Rd 8–10, 30 mm, 349-350  
mounting height  
Cable bracket, Rd 8–10 mm with bonding base, 348  
Card reader PCS-CS..., 293  
Clamp lock for strip earthing clip, 303  
Clamp clips for screen connection, 306  
Clamping block for Rd 16 mm, 353  
Clamping block for Rd 8-10 mm, 352  
Clamping shoe, 367  
Clip branch terminal, 306  
Closed spark gap with lightning current carrying, 288  
capability  
Coaxial protection device for 7/16 connection:, 247  
male/female  
Coaxial protection device for BNC connection:, 245  
female/female  
Coaxial protection device for BNC connection:, 245  
male/female  
Coaxial protection device for BNC connection:, 246  
male/male  
Coaxial protection device for F connection:, 247  
female/female  
Coaxial protection device for F connection:, 247  
male/female

## C

Coaxial protection device for N connection:, 246  
female/female  
Coaxial protection device for N connection:, 246  
male/female  
Coaxial protection device for SAT and cable, 248  
multiswitch  
Coaxial protection device for SMA connection:, 247  
female/female  
Coaxial protection device for TNC connection:, 246  
male/female  
Coaxial protection devices for S-UHF connection:, 245  
female/female  
Coaxial protection devices for S-UHF connection:, 245  
male/female  
CombiController V50 base, 152  
CombiController V50 base with remote signalling, 152  
Combination arrester for 10Base2-/10Base5, 250  
networks  
Combination arrester for 4-wire information, 252  
technology systems with RJ45  
Combination arrester upper part, 142  
Combination arrester upper part 280 V, 163  
Combination arrester upper part 320 V, 163  
Combination arrester upper part 385 V, 163  
Combination arrester upper part 150 V, 163  
Combination arrester upper part 150 V, 151  
Combination arrester upper part 280 V, 151  
Combination arrester, 1-pole, 137, 155, 158, 162  
Combination arrester, 1-pole + NPE, 154, 156  
Combination arrester, 1-pole + NPE with remote, 157  
signalling  
Combination arrester, 1-pole NPE, 136, 156  
Combination arrester, 1-pole with function display, 137  
Combination arrester, 2-pole, 155, 158, 162  
Combination arrester, 2-pole + NPE, 156  
Combination arrester, 3-pole, 137, 158, 162  
Combination arrester, 3-pole + NPE, 136, 154, 156, 161  
Combination arrester, 3-pole + NPE with function, 136  
display  
Combination arrester, 3-pole + NPE with remote, 157, 161  
signalling  
Combination arrester, 3-pole + NPE, with acoustic, 157, 161  
signalling  
Combination arrester, 3-pole with function display, 137  
Combination arrester, 3-pole with remote signalling, 159  
Combination arrester, 3-pole, with acoustic signalling, 159  
Combination arrester, 4-pole, 158, 162  
Combination arrester, 4-pole in housing with remote, 160  
signalling  
Combination arrester, 4-pole with remote signalling, 159  
Combination arrester, 4-pole, with acoustic signalling, 159  
Combination arrester, 4-pole, with voltage monitoring, 160  
Combination protection device for ISDN, 237  
Combination protection device for ISDN and DSL, 237  
systems  
Combination protection device for ISDN bus side, 239  
Combination protection device for ISDN RJ11, 238  
Combination protection device for ISDN RJ45, 238  
Combination protection for two-core systems with HF, 265  
applications 24 V  
Combination protection for two-core systems with HF, 265  
applications 5 V  
Complete photovoltaic block V20, 1000 V DC, 223  
Complete photovoltaic block V20, 1000 V DC with IR, 223  
Complete photovoltaic block V20, 600 V DC, 222  
Complete photovoltaic block V20, 600 V DC with IR, 222  
Complete photovoltaic block V25, 900 V DC, 221  
Complete photovoltaic block V25, 900 V DC with IR, 221  
Complete photovoltaic block V50, 600 V DC, 220  
Complete photovoltaic block V50, 600 V DC with IR, 220  
Concrete block for FangFix system 10 kg, 334, 384  
Concrete block for FangFix-System 16 kg, 333, 338, 384, 392  
Connecting bridge, 143

**C**

Connecting bridge for V10 Compact 200 mm, 201  
 Connecting bridge for V10 Compact 400 mm, 201  
 Connecting bridge, Multibase base, 164  
 Connection and bridging component, 369  
 Connection and end piece, 358  
 Connection and end piece with connector, 358  
 Connection and end piece with connector and, 358  
 pressure trough  
 Connection and end piece, DIN version, 358  
 Connection and expansion strip, 369  
 Connection clip, 374  
 Connection clip for earthing rod on flat conductor, 318  
 Connection clip for earthing rod or cables, 318  
 Connection clip for earthing rod to round cables Rd, 318  
 8-10  
 Connection clip for earthing rod, universal, 318  
 Connection component, 369  
 Connection element, 388  
 Connection element for installation in the insulated, 391  
 interception rod isFang IN  
 Connection joint, 384  
 Connection piece, 383  
 Connection plate for one isCon® cable, 392  
 Connection plate for two isCon® cables, 392  
 Connection strap for Parex spark gap, 288  
 Connection terminal for reinforced steels, 322  
 Connection terminal for round cable, 322  
 Connection terminal to 14 mm, 363  
 Connection terminal, equipotential bonding, Rd 16, 306, 368  
 mm  
 Connection terminal, equipotential bonding, Rd 8-10, 305, 367  
 mm  
 Connector Rd 8-10 mm, double, 356  
 Connector Rd 8-10 mm, single, 356  
 Connector Rd 8-10 mm, triple, 357  
 Connector, Rd 8-10 mm with M10 thread, 356  
 Connector, Rd 8-10 mm with pressure trough, 357  
 Connector, Rd 8-10 mm, double, with pressure, 357  
 trough  
 Construction clamp to 20 mm, 363  
 Contact strip for 1801 VDE, 297  
 Copper bridges with step width 17.6 mm, 206  
 Copper bridges with step width 53.4 mm, 206  
 Copper flat conductor, 310  
 Cover for BigBar equipotential bonding rail, 301  
 Cover hood for 1801 VDE, 297  
 Cover hood for 1809, 298  
 Crossbar for equipotential bonding rail, 301  
 Crossbar for Rd 8-10 mm, 351  
 Crossbar, round cables and interception rods 16 mm, 353  
 Cross-connector for flat conductor, 319  
 Cross-connector for flat conductor, with intermediate, 319  
 plate  
 Cross-connector for flat conductors and round cables, 321  
 Cross-connector for Rd 8-10 x Rd 16 mm, 362  
 Cross-connector for round cables and flat conductors, 360  
 Cross-connector for round cables and flat conductors, 360  
 DIN  
 Cross-connector for round cables Rd 8-10, 319  
 Cross-connector for round cables Rd 8-10 x Rd 16, 320  
 Cross-connector Rd 8-10 mm, 361  
 Cross-connector Rd 8-10 mm, wide version, 361  
 Cross-connector with intermediate plate for Rd 8-10, 361  
 mm  
 Cross-connector with intermediate plate for Rd 8-10, 361-362  
 mm, wide version  
 Cross-connector with intermediate plate for Rd 8-10, 362  
 x Rd 16 mm  
 Cross-connector with intermediate plate for round, 320  
 cables, Rd 8-10

**C**

Cross-connector with intermediate plate for round, 320  
 cables, Rd 8-10 x Rd 16

**D**

Data cable protection device for coaxial TV / camera, 251  
 systems  
 Decoupling inductivity, 143  
 Diagonal clamp, 321  
 Diagonal clamp with bolt, 321  
 DIN cross-connector for flat conductor, 319  
 DIN cross-connector for flat conductor, with, 319  
 intermediate plate  
 Directional irons, 378  
 DK connector, 383  
 Double connection terminal, equipotential bonding,, 368  
 Rd 8-10 mm  
 Downspout clip, 370  
 Downspout clip for routing Rd 8-10 mm behind pipe, 370-371

**E**

Earth connection terminal for round cable and flat, 306  
 conductor  
 Earth entry rod with separating piece and connector, 316, 375  
 Earth entry rod, tapered and partially insulated, 316, 375  
 Earthing clip, type 925, 304  
 Earthing clip, type 942, 304  
 Earthing clip, type 952, 305  
 Earthing connection block, 323  
 Earthing fixed point, 322  
 Earthing plate, 317  
 Earthing rod for standard applications, 312  
 Earthing screw with fastening thread, 306  
 Earthing strap, type 950, 304  
 Earthing terminal for cables and flat conductors, 306  
 Earthing terminal for fastening on earthing strap, 304  
 Earthing terminal type 951, 305  
 Empty housing for arrestors, 164  
 End piece, 322-323, 368, 383  
 Equipotential bonding bar for bathroom, 299  
 Equipotential bonding rail BigBar for industrial, 301  
 application  
 Equipotential bonding rail for indoors, VDE-tested, 296  
 Equipotential bonding rail for outside installation, 300  
 Equipotential bonding rail for small systems, 298  
 Equipotential bonding rail with metal base plate, 298  
 Equipotential bonding rail with plastic base plate, 297  
 Equipotential bonding rail, simple version, 299  
 Equipotential bonding rail, solid version, 298  
 Expansion piece, 323, 369  
 Explosion-proof, closed spark gap, 288  
 Extension, 384

**F**

FangFix reducing sleeve, 384  
 Fastening bolt, 385  
 Fastening plate, 385  
 Fastening set for hat profile rail, 251  
 Fine power protection / adapter with cold device, 211  
 connector  
 Fine power protection / dado duct installation Modul, 213  
 45  
 Fine power protection / socket bar, 211  
 Fine power protection for all installation systems, 212  
 Fine power protection for through wiring, 212  
 Fine power protection with holder for GB2 and GB3, 212  
 mounting boxes  
 Fine protection device for ISDN RJ11, 238  
 Fine protection device for ISDN RJ45, 238  
 Fine protection for 10Base2-/10Base5 networks, 250  
 Fine protection for 15-pin RS232 interface, 255

# Alphabetical table of contents

## F

Fine protection for 25-pin RS232 interface, 255  
Fine protection for 25-pin RS485 interface, 256  
Fine protection for 4-wire information technology, 253 systems RJ45  
Fine protection for 4-wire information technology, 252 systems with RJ45  
Fine protection for 8-wire information technology, 253 systems RJ45  
Fine protection for 9-pin RS232 interface, 255  
Fine protection for 9-pin RS485 interface, 256  
Fine protection for Ethernet networks (Class D/CAT, 250 5)  
Fine protection for RS232 with screwless terminals, 257  
Fine protection for RS485 with screwless terminals, 257  
FineController for ISDN telephone systems and, 211 terminals  
FineController for protective contact socket, 210  
FineController for SAT systems and receivers, 210  
FineController for telephone systems and terminals, 210  
FineController for telephone systems with RJ11, 211  
FineController for video, TV and HiFi systems, 210  
Flat conductor adapter for roof cable holder, type, 345 165/MBG  
Flat conductor terminal from FL 30 for 1801 VDE, 297  
Flat conductor terminal to FL 30 for 1801 VDE, 296  
Flat conductor, copper, 330  
Flat lead, 377  
Fold fastening, 385  
Folding and construction clamp, 10–20 mm, 362  
Folding clamp and connection terminal up to 10 mm, 365 plate thickness  
Folding clamp Rd 8-10 up to 10 mm plate thickness, 363-364  
Folding clamp up to 10 mm plate thickness, 363-364  
Folding clamp up to 5 mm plate thickness, 364

## G

Galvanised steel flat conductor, 310  
Galvanised steel flat conductor for earth, 330  
Gutter clamp for all bead thicknesses, 365-366  
Gutter clamp for bead thickness 15–22 mm, 366  
Gutter clamp RK-FIX, 365

## H

Hammer insert for LightEarth earthing rod, 315  
Hammer insert, type 2500, for earthing rods ST, BP, 314 and OMEX  
Hammer insert, type 2510, for earthing rods ST, BP, 314 and OMEX  
Hammer insert, type 2520, for earthing rods ST, BP, 314 and OMEX  
Hammer insert, type 2530, for earthing rods ST, BP, 314 and OMEX  
Hammer insert, type 2531, for earthing rods ST, BP, 314 and OMEX  
Hammer insert, type 2535, for earthing rods ST, BP, 315 and OMEX  
Hammer insert, type 2536, for earthing rods ST, BP, 315 and OMEX  
Hinge crossbar for FL 30 mm, 351  
Hinge crossbar for Rd 8-10 mm, 351  
Holder for installation in GB2 and GB3 mounting, 212 boxes  
Holder, V support, 385

## I

Impact head for earthing rods ST, BP and OMEX, 314  
Impact head for LightEarth earthing rod, 313  
Impact point for LightEarth earthing rod, 313  
Impact point for OMEX earthing rod, 313  
Impact point for ST and BP earthing rod, 313  
Inspection door, 376  
Installation strip for strip earthing clip, 303

## I

Insulated interception rod, 337, 391  
Insulated interception rod for inner-routed isCon cable, 338, 393  
Insulated interception rod for inner-routed isCon cable, 337, 390 with side exit  
Insulated lightning protection set, 3-corner fastening, 382  
Insulated lightning protection set, IR fastening, 382  
Insulated lightning protection set, V fastening, 382  
Insulated lightning protection set, VRS fastening, 382  
Insulated spacer, 387  
Insulating rod, 382  
Insulation removal pliers, 388  
Interception rod for FangFix-Junior, 332  
Interception rod holder for ridge tiles, 336  
Interception rod holder for sloping roof, 335  
Interception rod, one end rounded, 334  
Interception rod, one end rounded with connection, 334 strap  
Interception tip, 332, 386  
Interception/earth entry rod with connection tabs, 316, 335, 375  
Interception/earth entry rod with connection tabs and, 335 connector  
Interception/earth entry rod, rounded-off on both, 315, 332-333, 375 sides  
isCon® arrestor, 388  
isCon® arrestor in light grey, 388  
isFang interception rod, 337  
isFang interception rod stand, 337, 391  
isFang interception rod stand with side exit, 337, 391  
isFang support for corner pipe mounting, 50 x 50 mm, 339  
isFang support for pipe mounting,  $\varnothing$  40–50 mm, 339, 394  
isFang support for pipe mounting,  $\varnothing$  50–300 mm, 339, 393  
isFang support for pipe mounting,  $\varnothing$  50–60 mm, 339  
isFang support for spaced pipe mounting,  $\varnothing$  50–300, 339, 394 mm  
isFang support for wall mounting, 15 mm spacing, 338, 393  
isFang support for wall mounting, 200–300 mm, 338, 393 spacing  
isFang support for wall mounting, 80 mm spacing, 338, 393  
isFang-3B threaded rod, 338, 392  
ISOLAB measuring system arrestor tester, 292

## K

K connector, 383

## L

LightEarth earthing rod, 312  
Lightning arrestor/combo arrestor base, 143  
Lightning current and surge arrestor, 1-pole + NPE, 148  
Lightning current and surge arrestor, 1-pole + NPE, 149 with remote signalling  
Lightning current and surge arrestor, 2-pole + NPE, 148  
Lightning current and surge arrestor, 3-pole, 150  
Lightning current and surge arrestor, 3-pole + NPE, 148  
Lightning current and surge arrestor, 3-pole + NPE, 149 with remote signalling  
Lightning current and surge arrestor, 3-pole with, 150 remote signalling  
Lightning current and surge arrestor, 4-pole, 150  
Lightning current and surge arrestor, 4-pole with, 150 remote signalling  
Lightning current arrestor, 1-pole, 141  
Lightning current arrestor, 1-pole NPE, 140  
Lightning current arrestor, 1-pole with function display, 141  
Lightning current arrestor, 3-pole, 141  
Lightning current arrestor, 3-pole + NPE, 140  
LSA-Plus technology / LSA basic protection, 241  
LSA-Plus technology / LSA connection strip, 241  
LSA-Plus technology / LSA earthing rail for LSA-BF, 242  
LSA-Plus technology / LSA earthing strip, 241  
LSA-Plus technology / LSA installation trough, 242  
LSA-Plus technology / LSA separating strip, 241  
LSA-Plus technology / LSA simple tool, 243

**L**

LSA-Plus technology / protective housing, 243  
 LSA-Plus technology/LSA basic and fine protection, 242

**M**

Magnetic card and holder, 376  
 Magnetic card and holder MK-B, 293  
 Magnetic card holder, 377  
 Magnetic card holder PCS-H, 293  
 Magnetic card PCS, 293, 376  
 Magnetic card reader, 377  
 Malleable iron separating piece, 374  
 MCR protection for 2-pin for power supply with leak, 217, 263  
 current-free remote signalling, 110 V AC/DC  
 MCR protection for 2-pin for power supply with leak, 217, 263  
 current-free remote signalling, 230 V AC/DC  
 MCR protection for 2-pin for power supply with leak, 217, 263  
 current-free remote signalling, 24 V AC/DC  
 MCR protection for 2-pin for power supply with, 216, 262  
 remote signalling, 110 V AC/DC  
 MCR protection for 2-pin for power supply with, 261  
 remote signalling, 12 V AC/DC  
 MCR protection for 2-pin for power supply with, 216, 262  
 remote signalling, 230 V AC  
 MCR protection for 2-pin for power supply with, 216, 261  
 remote signalling, 24 V AC/DC  
 MCR protection for 2-pin for power supply with, 261  
 remote signalling, 48 V AC/DC  
 MCR protection for 2-pin for power supply with, 262  
 remote signalling, 60 V AC  
 MCR protection for 2-pin for power supply, 110 V, 215, 260  
 MCR protection for 2-pin for power supply, 12 V, 214, 259  
 MCR protection for 2-pin for power supply, 230 V, 215, 260  
 MCR protection for 2-pin for power supply, 24 V, 214, 259  
 MCR protection for 2-pin for power supply, 48 V, 214, 259  
 MCR protection for 2-pin for power supply, 60 V, 214, 259  
 MCR protection for explosive areas, 2-pole, 24 V, 282  
 MCR protection for explosive areas, 3-pole, 24 V, 282  
 Medium and fine protection for two-core systems 110, 267, 270,  
 V 272  
 Medium and fine protection for two-core systems 12, 266, 269,  
 V 271  
 Medium and fine protection for two-core systems 24, 266, 268-  
 V 269, 271  
 Medium and fine protection for two-core systems 48, 266, 269,  
 V 271  
 Medium and fine protection for two-core systems 5 V, 266, 268-  
 269, 271  
 Medium and fine protection for two-core systems 60, 270  
 V  
 M-Quick cable bracket PA, 390  
 Multi-Adapter, 386  
 Multibase MB25 base, 191  
 Multibase MB25 base with remote signalling, 191  
 Mushroom-shaped interceptor with connectors, 336

**N**

Number plates, 326, 374

**O**

OMEX earthing rod, 313

**P**

PA cable bracket with tightening strap, 389  
 PA roof cable holder, sloping roof, 390  
 Parallel clamp, 322  
 Parallel connector Rd 8 mm, M10 x 30, 359  
 Parallel connector Rd 8–10 mm, M6 x 20, 359  
 Parallel connector Rd 8–10 mm, M8 x 25, 358  
 Photovoltaic housing 600 V DC with connection, 227  
 terminals with IR  
 Photovoltaic housing 900 V DC with connection, 227  
 terminals with IR

**P**

Photovoltaic housing for inverter with 2 MPP trackers,, 224  
 type 1+2, 900 V DC  
 Photovoltaic housing for inverter with 2 MPP trackers,, 224  
 type 2, 1000 V DC  
 Photovoltaic housing for inverter with 2 MPP trackers,, 230  
 unequipped  
 Photovoltaic housing for inverter with 3 MPP trackers,, 224  
 type 1+2, 900 V DC  
 Photovoltaic housing for inverter with 3 MPP trackers,, 224  
 type 2, 1000 V DC  
 Photovoltaic housing for inverter with 3 MPP trackers,, 230  
 unequipped  
 Photovoltaic housing with 4 fuses, 225  
 Photovoltaic housing with 6 fuses, 225  
 Photovoltaic housing with connection terminals, type, 226  
 1+2, 600 V DC  
 Photovoltaic housing with connection terminals, type, 226  
 1+2, 900 V DC  
 Photovoltaic housing with connection terminals, type, 226  
 2, 1000 V DC  
 Photovoltaic housing with connection terminals,, 230  
 unequipped  
 Photovoltaic housing with MC 4 connector,, 230  
 unequipped  
 Photovoltaic housing with V-Tec entry, 228  
 Photovoltaic system solution, type 1+2, with MC, 229  
 connector, 600 V DC  
 Photovoltaic system solution, type 1+2, with MC, 229  
 connector, 900 V DC  
 Photovoltaic system solution, type 2, with MC, 229  
 connector, 1000 V DC  
 Photovoltaic system solution, type 2, with MC, 229  
 connector, 600 V DC  
 Photovoltaic upper part– lightning and surge arrestors, 231  
 Photovoltaic upper part– surge arrestors, 231  
 Photovoltaic upper part – lightning and surge, 231  
 arrestors  
 Photovoltaic upper part – surge arrestors, 231  
 Pipe clamp, 371  
 Pipe fastening, 385  
 Plastic corrosion protection strip, 326, 377  
 Potential and earth connection block, 302  
 Potential connection, 388  
 Potential connection clip for mounting on isFang, 392  
 Potential connection for installation in the insulated, 391  
 interception rod isFang IN  
 Profile earthing rod connection with connecting lug, 316  
 Profile earthing rod connection with round cable lug, 317  
 Profile rail, 306  
 Profile earthing rod connection with strip steel lug, 316  
 Protection package, SAT applications, 207  
 Protection package, telecommunications, 207  
 Protection package, TV, 207  
 Protection set MCD + V20 1-pole + NPE, 167  
 Protection set MCD + V20 3-pole, 168  
 Protection set MCD + V20 3-pole + NPE, 167  
 Protection set MCD + V20 3-pole + NPE with remote, 167  
 signalling  
 Protection set MCD + V20 3-pole with remote, 168  
 signalling  
 Protection set MCD + V20, leakage current-free, 3-, 170  
 pole  
 Protection set MCD + V20, leakage current-free, 3-, 169  
 pole + NPE  
 Protection set MCD + V20, leakage current-free, 3-, 169  
 pole + NPE with remote signalling  
 Protection set MCD + V20, leakage current-free, 3-, 170  
 pole with remote signalling  
 Protective spark gap, 289  
 PV base, 2-pole in Y circuit, 232  
 PV base, 2-pole in Y circuit with remote signalling, 232  
 PV base, 3-pole in Y circuit, 232  
 PV base, 3-pole in Y circuit with remote signalling, 232



## Alphabetical table of contents

### R

Rail stands for 1801 VDE, 297  
Remote signalling replacement connector for, 164, 197  
Multibase  
Replacement connector for VF remote signalling, 280  
Ridge conductor holder with tensioning spring, 340  
Rod clamp, 374  
Rod holder, 386  
Rod holder for 16 mm interception and earth entry, 352 rods  
Rod holder for 16 mm interception and earth entry, 353 rods, with square pin  
Rod holder for 16 mm interception and earth, 353 entry rods, with screw and anchor  
Rod holder for 20 mm rods, 353-354  
Roof cable holder for flat roofs, 345  
Roof cable holder for flat roofs, plastic sleeve, 345  
Roof cable holder for flat roofs, recyclable, 346  
Roof cable holder for flat roofs, with increased base, 345 section  
Roof cable holder for flat roofs, with raised cable, 346 bracket  
Roof cable holder for flat roofs, without base, 345  
Roof cable holder for ridge tiles with M8 threaded, 341 bolts  
Roof cable holder for ridge tiles, 180–240 mm, Rd, 341 8–10  
Roof cable holder for ridge tiles, 185–260 mm, Rd 8, 340  
Roof cable holder for ridge tiles, 185–260 mm, Rd, 340-341 8–10  
Roof cable holder for slated roofs with M8 threaded, 344 bolts  
Roof cable holder for slated roofs, crimped, Rd 8, 342-343  
Roof cable holder for slated roofs, crimped, Rd 8–10, 343  
Roof cable holder for slated roofs, Rd 8, 343  
Roof cable holder for slated roofs, Rd 8–10, 343  
Roof cable holder for tiled and slated roofs, 74 mm, 344 height  
Roof cable holder for tiled and slated roofs, Rd 8–10, 343  
Roof cable holder for tiled roofs, angled, flexible, Rd, 342 8  
Roof cable holder for tiled roofs, angled, Rd 8, 342  
Roof cable holder for tiled roofs, angled, Rd 8–10, 342  
Roof cable holder for tiled roofs, Rd 8, 341  
Roof cable holder for tiled roofs, Rd 8–10, 341-342  
Roof cable holder for tiled, slated and corrugated, 344 roofs, Rd 8  
Roof cable holder for tiled, slated and corrugated, 344 roofs, Rd 8–10  
Roof cable holder for tiled, slated and corrugated, 344 roofs, with cable bracket  
Roof cable holder for tiled, slated and corrugated, 344 roofs, with crossbar  
Roof cable holder, 55 mm, suitable for bonding, 346 straight to flat roofs  
Roof cable holder, suitable for bonding straight to flat, 346 roofs  
Roof gutter clamp for all bead thicknesses, 366  
Roof penetration, 336  
Round cable terminal from 25 mm<sup>2</sup> for 1801 VDE, 296  
Round cable terminal to 25 mm<sup>2</sup> for 1801 VDE, 296  
Round cable, aluminium, 311, 331  
Round cable, aluminium with PVC sheathing, 331  
Round cable, aluminium, with PVC sheathing, 311  
Round cable, copper, 311, 331  
Round cable, galvanised steel, 310, 330  
Round cable, galvanised steel with PVC jacketing, 310, 330  
Round cable, stainless steel, 311, 331

### S

Screw-in anchor with M6 thread, 378  
Screw-in anchor with M8 thread, 378  
Screwless cable bracket for Rd 8 mm, fastening with, 347 screw and anchor

### S

Screwless cable bracket for Rd 8 mm, through-way Ø, 347 5 mm  
Screwless cable bracket for Rd 8 mm, through-way Ø, 347 7 mm  
Screwless cable bracket, raised construction type, for, 347 Rd 8 mm, through-way Ø 5 mm  
Separating piece for Rd 8–10 and FL 30 mm, 373  
Separating piece for Rd 8–10 and FL 30–40 mm, 373  
Separating piece, closed, 372  
Separating piece, open, 372  
Series protection device, 2-pole, 12 V version, 278  
Series protection device, 2-pole, 24 V version, 275, 279  
Series protection device, 2-pole, 48 V version, 276  
Series protection device, 2-pole, 5 V version, 274  
Series protection device, 3-pole, 24 V version, 275  
Series protection device, 3-pole, 48 V version, 276  
Series protection device, 3-pole, 5 V version, 274  
Series protection device, 4-pole, 12 V version, 278  
Series protection device, 4-pole, 24 V version, 275, 279  
Series protection device, 4-pole, 24 V version, Ex-, 284 tested  
Series protection device, 4-pole, 48 V version, 276  
Series protection device, 4-pole, 48 V version, Ex-, 284 tested  
Series protection device, 4-pole, 5 V version, 274, 277  
Series protection device, 4-pole, 5 V version, Ex-, 284 tested  
Shock Guard for Multibase base, 164  
Shock Guard locking, 206  
Snow catching grate clamp, 367  
Spacer, 323, 390  
Spacer clip for flat conductor with fastening hole Ø, 324 6.5  
Spacer clip for flat conductor, with fastening hole Ø 7, 324  
Spacer clip for flat conductor, with polyamide base, 324  
Spacer clip for flat conductor, with square pin, 325  
Spacer clip for flat conductor, with steel spreading, 325 anchor Ø 10  
Spacer clip for flat conductor, with threaded, 324 connection M6  
Spacer clip for flat conductor, with wood screw and, 325 spacer  
Spare blade, 388  
Spark gap / surge voltage protection for coupling, 289 earthing systems  
Stainless steel flat conductor, 310, 330  
Stand 16 kg with female thread, 335, 383  
Stand 6.9 kg with female thread, 335, 383  
Stand for FangFix Junior system, 332  
Stand for FangFix system 10 kg, 333  
Stand for FangFix system 16 kg, 333  
starQuick anchor M6, 389  
starQuick cable bracket PA, 389  
starQuick nut M6, 389  
Straight connector Rd 8 mm, 359  
Straight connector Rd 8–10 mm, 359  
Strip clip for fastening the isCon® cable to insulated, 393 interception rods  
Strip earthing clip VA, 303  
Strip earthing clip, nickel-plated, 303  
Strip steel crimp, 326  
Surge arrester Compact 150 V, 200  
Surge arrester Compact 280 V, 200  
Surge arrester Compact 385 V, 200  
Surge arrester Compact with acoustic signalling, 200  
Surge arrester, 1-pole, 178, 181, 186, 188  
Surge arrester, 1-pole + NPE, 176, 179, 185, 202  
Surge arrester, 1-pole + NPE with remote signalling, 180  
Surge arrester, 1-pole NPE, 179, 195  
Surge arrester, 1-pole with remote signalling, 182  
Surge arrester, 1-pole, leakage current-free, 192  
Surge arrester, 2-pole, 178, 181, 186, 188

## S

Surge arrester, 2-pole + NPE, 176, 179  
 Surge arrester, 2-pole + NPE with remote signalling, 177, 180  
 Surge arrester, 2-pole with remote signalling, 182, 189  
 Surge arrester, 2-pole, with acoustic signalling, 183  
 Surge arrester, 3-pole, 178, 181, 186, 188  
 Surge arrester, 3-pole + NPE, 176, 179, 185, 202-203  
 Surge arrester, 3-pole + NPE with acoustic signalling, 180  
 Surge arrester, 3-pole + NPE with remote signalling, 177, 180, 185, 202  
 Surge arrester, 3-pole with acoustic signalling, 183  
 Surge arrester, 3-pole with fuse monitoring, 184  
 Surge arrester, 3-pole with NPE, 191  
 Surge arrester, 3-pole with NPE and remote signalling, 191  
 Surge arrester, 3-pole with remote signalling, 182, 187, 189  
 Surge arrester, 4-pole, 181, 186, 188  
 Surge arrester, 4-pole with acoustic signalling, 183  
 Surge arrester, 4-pole with fuse monitoring, 184  
 Surge arrester, 4-pole with remote signalling, 182, 189  
 Surge protection for high-speed networks up to 10, 250 GBit (Class EA/CAT6A)

## T

T connector, 382  
 T connector Rd 8 mm, 359  
 T connector Rd 8–10 mm, 359-360  
 T connector Rd 8-10 mm, triple-screwed, 360  
 Tapered pipe interception rod, 332  
 Terminal for FangFix system, 334  
 Testing unit for lightning barriers, 292  
 TrayFix mounting adapter for mesh cable trays on, 334, 377  
 FangFix system

## U

Underfloor test box, 376  
 Underfloor test box with integrated separation point, 376  
 Universal adapter for roof cable holder, type, 345 165/MBG  
 Universal bi-metal separating piece, 373  
 Universal cable bracket Rd 8–10 mm, 348  
 Universal cable bracket Rd 8–10 mm with pre-, 348 mounted wood screw  
 Universal cable bracket Rd 8–10 mm, copper-plated, 348  
 Universal clamping block Rd 8–10 mm, 368  
 Universal downspout clip 60–130 mm, 369-370  
 Universal separating piece, 372-373  
 Upper part total spark gap between N and PE 255 V, 164, 195  
 Upper part, combination arrester with function display, 142  
 Upper part, lightning current arrester, 142  
 Upper part, lightning current arrester with function, 142 display  
 Upper part, surge arrester 150 V, 193, 204  
 Upper part, surge arrester 280 V, 193, 204  
 Upper part, surge arrester 320 V, 193, 204  
 Upper part, surge arrester 335 V, 194  
 Upper part, surge arrester 385 V, 194, 204  
 Upper part, surge arrester 440 V, 194  
 Upper part, surge arrester 550 V, 194  
 Upper part, surge arrester 75 V, 193  
 Upper part, surge protection, leak current-free, 195

## V

VA cable bracket, 389  
 VA cable bracket with tightening strap, 389  
 VA roof cable holder, sloping roof, 390  
 Variable bi-metal quick connector, 355  
 Variable earthing connector Rd 6-8 / 8-10 mm, 355-356  
 Variable earthing terminal, 322  
 Vario quick connector, 355  
 Vario quick connector Rd 8-10x16, 356  
 VG housing with MC 50-B/3, 139  
 VG housing with MC 50-B/3+1, 138

## V

VG housing with MCD 50-B/3, 139  
 VG housing with MCD 50-B/3+1, 138

## W

Wall connection, 383  
 Wall connection, angled, 385  
 Washer for cable bracket, type 177, 347  
 Water repellent, 386  
 Wedge connector, 323  
 Wire straightening machine, 378

## Z

Zinc repairs, 377









GTIN	Art. no.	Price	Page	GTIN	Art. no.	Price	Page	GTIN	Art. no.	Price	Page
589071	<b>5351 37 5</b>	/100 pc.	370	581378	<b>5408 06 0</b>	/100 pc.		575229	<b>5412 81 1</b>	/100 pc.	353
542721	<b>5351 45 6</b>		371			/pc.					
542727	<b>5351 47 2</b>		371	587269	<b>5408 06 4</b>		389	542967	<b>5416 56 6</b>		374
				587270	<b>5408 06 6</b>		389				
542757	<b>5400 15 5</b>		315	587274	<b>5408 06 8</b>		389			/pc.	
562905	<b>5400 62 7</b>		315	587275	<b>5408 07 2</b>		390	590049	<b>5420 00 8</b>		322
				587276	<b>5408 07 4</b>		390	562929	<b>5420 01 6</b>		322
590133	<b>5401 77 1</b>		334			/100 pc.				/100 pc.	
542781	<b>5401 80 1</b>		334	567492	<b>5408 10 1</b>		384	575157	<b>5420 50 4</b>		315
542787	<b>5401 83 6</b>		334			/pc.		533157	<b>5420 53 9</b>		315
589839	<b>5401 85 2</b>		334	569073	<b>5408 10 5</b>		382				
590211	<b>5401 87 9</b>		334	561320	<b>5408 10 7</b>		382	543009	<b>5424 10 0</b>		335
503481	<b>5401 97 0</b>		332	561321	<b>5408 10 8</b>		382	543021	<b>5424 15 1</b>		316
510561	<b>5401 98 0</b>		332	561322	<b>5408 10 9</b>		382	543033	<b>5424 20 8</b>		316
510777	<b>5401 98 3</b>		332	563673	<b>5408 14 8</b>		382				
510867	<b>5401 98 6</b>		332	568149	<b>5408 15 6</b>		382			/pc.	
510873	<b>5401 98 9</b>		332	561323	<b>5408 15 8</b>		382	590145	<b>5430 01 1</b>		316
504535	<b>5401 99 3</b>		332	589581	<b>5408 24 5</b>		383	590157	<b>5430 06 2</b>		316
505080	<b>5401 99 5</b>		332	561324	<b>5408 24 7</b>		383			/100 pc.	
				589587	<b>5408 29 6</b>		383	543057	<b>5430 15 1</b>		316
542805	<b>5402 10 7</b>		335	561325	<b>5408 29 8</b>		383				
542817	<b>5402 15 8</b>		335	567447	<b>5408 35 0</b>		383				
542841	<b>5402 80 8</b>		334	561326	<b>5408 35 2</b>		383			/pc.	
542847	<b>5402 85 9</b>		334	567441	<b>5408 39 3</b>		383	611761	<b>6117 46 5</b>		213
		/pc.		561327	<b>5408 39 5</b>		383	500622	<b>6117 46 7</b>		213
567473	<b>5402 86 4</b>		337	567435	<b>5408 45 8</b>		386	611767	<b>6117 47 3</b>		213
567474	<b>5402 86 6</b>		337	567429	<b>5408 50 4</b>		384	500621	<b>6117 47 5</b>		213
567475	<b>5402 86 8</b>		337	561328	<b>5408 50 6</b>		384				
567476	<b>5402 87 0</b>		337	567423	<b>5408 55 5</b>		384				
567479	<b>5402 87 2</b>		337	561329	<b>5408 55 7</b>		384			/100 pc.	
567480	<b>5402 87 4</b>		337	567417	<b>5408 62 8</b>		384	604908	<b>6404 00 6</b>		306
567481	<b>5402 87 6</b>		337	561331	<b>5408 63 0</b>		384	604920	<b>6404 01 4</b>		306
567482	<b>5402 87 8</b>		337	567381	<b>5408 68 7</b>		383				
567485	<b>5402 88 0</b>		337	561330	<b>5408 68 9</b>		383				
		/100 pc.		567375	<b>5408 73 3</b>		386				
542853	<b>5402 89 1</b>		335	554277	<b>5408 80 6</b>		387				
589791	<b>5402 95 6</b>		335	554283	<b>5408 81 4</b>		387				
				577049	<b>5408 82 0</b>		387				
573842	<b>5403 10 0</b>		334	500460	<b>5408 84 9</b>		386				
507005	<b>5403 10 3</b>		333	500973	<b>5408 85 2</b>		386				
507006	<b>5403 11 0</b>		333	585955	<b>5408 93 0</b>		337				
507007	<b>5403 11 7</b>		334	585956	<b>5408 93 2</b>		337				
507008	<b>5403 12 4</b>		334	587161	<b>5408 93 4</b>		338				
554871	<b>5403 20 0</b>		333	587162	<b>5408 93 6</b>		338				
511063	<b>5403 20 5</b>		333	587166	<b>5408 93 8</b>		337				
554877	<b>5403 21 9</b>		334	587167	<b>5408 94 0</b>		337				
554889	<b>5403 22 7</b>		333	567005	<b>5408 94 2</b>		337				
554895	<b>5403 23 5</b>		333	578533	<b>5408 94 3</b>		337				
592632	<b>5403 23 8</b>		338	567006	<b>5408 94 6</b>		337				
		/pc.		578534	<b>5408 94 7</b>		337				
503487	<b>5403 30 8</b>		332	567007	<b>5408 95 0</b>		338				
503493	<b>5403 32 4</b>		332	567008	<b>5408 95 2</b>		338				
561357	<b>5403 33 0</b>		336	567009	<b>5408 95 4</b>		338				
581390	<b>5403 33 3</b>		336	584936	<b>5408 95 5</b>		339				
567073	<b>5403 33 5</b>		335	567010	<b>5408 95 6</b>		339				
		/100 pc.		584939	<b>5408 95 7</b>		339				
542865	<b>5405 06 8</b>		332	567011	<b>5408 95 8</b>		339				
		/pc.		584940	<b>5408 95 9</b>		339				
542871	<b>5405 76 9</b>		336	567012	<b>5408 96 0</b>		339				
		/100 m		567013	<b>5408 96 4</b>		339				
588812	<b>5407 99 5</b>		388	580243	<b>5408 96 6</b>		337				
588815	<b>5407 99 7</b>		388	580244	<b>5408 96 7</b>		337				
				567014	<b>5408 96 8</b>		337				
567457	<b>5408 00 2</b>		388	567493	<b>5408 96 9</b>		337				
567462	<b>5408 00 4</b>		388	567494	<b>5408 97 1</b>		338				
585426	<b>5408 00 6</b>		388	567497	<b>5408 97 2</b>		338				
		/pc.		567498	<b>5408 97 3</b>		338				
567463	<b>5408 00 9</b>		388	561332	<b>5408 97 6</b>		382				
567464	<b>5408 01 1</b>		388	561333	<b>5408 97 8</b>		382				
567468	<b>5408 02 2</b>		388	561334	<b>5408 98 0</b>		382				
586417	<b>5408 02 4</b>		391	561335	<b>5408 98 2</b>		382				
567469	<b>5408 02 6</b>		392	561336	<b>5408 98 4</b>		385				
567470	<b>5408 02 8</b>		392	561337	<b>5408 98 6</b>		385				
				561338	<b>5408 98 8</b>		385				
587156	<b>5408 03 1</b>		391	561341	<b>5408 99 0</b>		385				
567471	<b>5408 03 6</b>		388	561342	<b>5408 99 2</b>		385				
				561343	<b>5408 99 4</b>		385				
567486	<b>5408 04 3</b>		390	561344	<b>5408 99 6</b>		386				
567487	<b>5408 04 7</b>		390			/100 pc.					
567488	<b>5408 04 9</b>		390	542889	<b>5410 09 6</b>		353				
567472	<b>5408 05 2</b>		389	542907	<b>5410 30 4</b>		353				
567491	<b>5408 05 4</b>		389								
569966	<b>5408 05 6</b>		389	542961	<b>5412 60 9</b>		352				
581377	<b>5408 05 8</b>		389	544641	<b>5412 63 3</b>		352				
				575235	<b>5412 80 3</b>		353				

02\_TBS\_Masterkatalog\_Länder\_2012 / en / 10/04/2012 / LLExpport\_01433





Type	Dimensions/Colour/Div.	GTIN	Art. no.	Price	Page	Type	Dimensions/Colour/Div.	GTIN	Art. no.	Price	Page
157 L-VA	212/ V2A	5407171	5215 43 9	/100 pc.	343	204 KS-2000	2000/ St / F	5901457	5430 01 1	/pc.	375
157 NB-VA	260/ V2A	5903673	5215 27 7		343	204 KS-2500	2500/ St / F	5901570	5430 06 2		316
157 ND-VA	260/ V2A	5903796	5215 30 7		344	204 KS-2500	2500/ St / F	5901570	5430 06 2		375
159 K-VA	/ V2A	5813255	5216 81 8		344	205 B-M10 VA	M10/ V4A	5900498	5420 00 8		322
159 VA-V	/ V2A	5407959	5217 07 5		344	205 B-M12 VA	M12/ V4A	5629290	5420 01 6		322
163 100 CU	100/ Cu	5409939	5223 60 1		350						
163 100 FT	100/ St / FT	5409519	5223 10 5		350	213 1000 DIN	1000/ St / FT	5373575	5003 00 8		316
163 150 FT	150/ St / FT	5409632	5223 15 6		350	213 1000 M	1000/ St / FT	5373995	5003 25 3		316
163 200 FT	200/ St / FT	5409755	5223 20 2		350	213 1500 DIN	1500/ St / FT	5373636	5003 01 6		316
163 70 FT	70/ St / FT	5409458	5223 07 5		350	213 1500 F	1500/ St / FT	5374718	5003 77 6		317
						213 1500 M	1500/ St / FT	5374053	5003 26 1		316
165 B 100	/ St / FT	5408970	5218 82 9		346	213 2000 DIN	2000/ St / FT	5373698	5003 02 4		316
165 B 60	/ St / FT	5408918	5218 81 0		346	213 2000 F	2000/ St / FT	5374770	5003 78 4		317
165 KR	/ PE	5409038	5218 86 1		345	213 2000 M	2000/ St / FT	5374114	5003 28 8		316
165 KRB SO		5952213	5218 97 7		346	213 2500 DIN	2500/ St / FT	5373759	5003 03 2		316
165 MBG HFL	Black/ PP	5623052	5218 88 5	/pc.	345	213 2500 M	2500/ St / FT	5374176	5003 29 6		316
						213 3000 DIN	3000/ St / FT	5373810	5003 04 0		316
165 MBG UH	Black/ PP	5674580	5218 88 2		345	213 3000 M	3000/ St / FT	5374237	5003 31 8		316
165 MBG UH	Black/ PP	5674580	5218 88 2		390						
165 MBG-10	/ PA/PE	5408734	5218 67 5	/100 pc.	345	219 20 BP CU	1500/ St / Cu	5371717	5000 50 5		313
165 MBG-10 200	/ PE	5814634	5218 75 6		345	219 20 BP FT	1500/ St / FT	5371892	5000 94 7		312
165 MBG-8	/ PA/PE	5408857	5218 69 1		345	219 20 BP V4A	1000/ V4A	5740650	5000 85 8		312
165 MBG-8 200	/ PE	5904519	5218 74 8		345	219 20 BP V4A	1500/ V4A	5371830	5000 86 6		312
165 NBK 55	55/ PA	5904274	5218 31 4		346	219 20 OMEX FT	1500/ St / FT	5371298	5000 01 7		313
165 OBG-8	/ PE	5408796	5218 68 3		345	219 20 OMEX FT	2000/ St / FT	5371472	5000 20 3		313
165 R-8-10	/ PE	5625889	5218 99 7		346	219 20 ST FT	1000/ St / FT	5018049	5000 74 2		312
						219 20 ST FT	1500/ St / FT	5814450	5000 75 0		312
						219 25 BP FT	1500/ St / FT	5371953	5000 95 5		312
166 LS 70	70/ St / FT	5410416	5226 57 0		350	219 25 OMEX FT	1500/ St / FT	5371359	5000 02 5		313
						219 25 ST FT	1500/ St / FT	5111047	5000 76 9		312
168 8-10 M6	M6/ Zn / G	5411499	5229 16 2		349						
168 DIN 30	56/ Zn / G	5411734	5229 48 0		350						
168 DIN-K-M8	M8/ Zn / G	5412151	5229 83 9		349						
168 DIN-K-M8	M8/ Zn / Cu	5411611	5229 38 3		350	223 DIN MS	/ Zn / Cu	5423676	5335 25 6	/100 pc.	372
168 FL30-M6	56/ Zn / VZ	5411673	5229 46 4		350	223 DIN ZN	/ Zn / G	5423614	5335 20 5		372
168 FL40-M8	66/ TG / FT	5411970	5229 55 3		350	223 O DIN MS	/ Zn / Cu	5890119	5335 16 7		372
168 ZN-M6	M6/ Zn / Cu	5411550	5229 36 7		350	223 O DIN ZN	/ Zn / G	5890058	5335 14 0		372
172 AR	/ Al	5409090	5218 92 6		369	226 8-10	/ St / FT	5424215	5336 00 7		372
						226 CU	/ Cu	5424277	5336 02 3		373
176 A 100	100/ TG / F	5410652	5227 10 0		351	226 VA	/ V2A	5424338	5336 05 8		372
176 A 150	150/ TG / F	5410713	5227 15 1		351	226 ZV CU	/ V2A	5424451	5336 09 0		373
176 A 65	65/ TG / F	5410539	5227 07 0		351	226 ZV VA	/ Cu	5424390	5336 07 4		373
176 A 80	80/ TG / F	5410591	5227 08 9		351						
						233 8	/ St / FT	5424635	5336 30 9		373
177 20 CU	/ PA	5904991	5207 74 6		348	233 A VA	/ V2A	5424871	5336 45 7		373
177 20 KL	/ PA	5009726	5207 45 1		348	233 A ZV	/ Cu	5424932	5336 50 3		374
177 20 M8	/ PA	5404897	5207 44 4		348	233 VA	/ V2A	5424758	5336 34 1		373
177 20 VA B-HD	/ V2A	5915836	5207 90 1		347	233 ZV	/ V2A	5424819	5336 37 6		373
177 20 VA M6	/ V2A	5404774	5207 33 9	/100 pc.	347	237 N CU	/ Cu	5453673	5328 28 4		359
177 20 VA M8	/ V2A	5404835	5207 34 7		347	237 N FT	/ St / F	5453611	5328 20 9		359
177 20 VA-VK M6	/ V2A / Cu	5904878	5207 80 0		347						
177 20 VA-VK M8	/ V2A / Cu	5904939	5207 81 9		347	239	/ Zn / G	5423195	5329 07 8		359
177 30 CU	/ PA	5905059	5207 75 4		348						
177 30 M8	/ PA	5404958	5207 46 0		348	244	/ Zn / G	5417316	5311 03 9		359
177 35 VA M6	/ V2A	5735762	5207 34 2		347						
177 55 CU	/ PA	5905110	5207 76 2		348	245 8-10 CU	/ Cu	5417439	5311 15 2		360
177 55 M8	/ PA	5405016	5207 48 7		348	245 8-10 FT	/ St / FT	5417378	5311 10 1		359
177 B-HD20	/ PA	5336433	5207 85 1		348						
177 B-HD30	/ PA	5334811	5207 87 8		348	247 8-10 CU	/ Cu	5417552	5311 26 8		360
177 U	Light grey/ PP	5069546	5207 37 1		347	247 8-10 FT	/ St / FT	5417491	5311 20 9		360
194	Grey M8/ PA	5404651	5207 25 8		348	249 6-10 CU	40/ Cu	5816591	5311 41 7		356
						249 6-10 ST	40/ St / FT	5816584	5311 41 0		355
194 K	Grey M8/ PA	5110392	5207 26 6		348	249 8-10 ALU	44/ Al	5417736	5311 51 9		355
						249 8-10 ALU-OT	44/ Al	5466192	5311 58 5		305
				/kg		249 8-10 ALU-OT	44/ Al	5466192	5311 58 5		352
198 60	2160	5399674	5101 06 9		377	249 8-10 ALU-OT	44/ Al	5466192	5311 58 5		367
						249 8-10 CU	40/ Cu	5417798	5311 52 7		355
				/100 pc.		249 8-10 CU-OT	40/ Cu	5835394	5311 53 0		301
199 DIN	M8/ St / FS	5405252	5208 01 7		351	249 8-10 CU-OT	40/ Cu	5835394	5311 53 0		305
						249 8-10 CU-OT	40/ Cu	5835394	5311 53 0		352
200 V4A-1500	1500/ V4A	5751571	5420 50 4		315	249 8-10 CU-OT	40/ Cu	5835394	5311 53 0		367
200 V4A-1500	1500/ V4A	5751571	5420 50 4		333	249 8-10 ST	40/ St / FT	5417675	5311 50 0		355
200 V4A-1500	1500/ V4A	5751571	5420 50 4		375	249 8-10 ST-OT	40/ St / FT	5737063	5311 50 3		305
200 V4A-2000	2000/ V4A	5331575	5420 53 9		315	249 8-10 ST-OT	40/ St / FT	5737063	5311 50 3		352
200 V4A-2000	2000/ V4A	5331575	5420 53 9		333	249 8-10 ST-OT	40/ St / FT	5737063	5311 50 3		367
200 V4A-2000	2000/ V4A	5331575	5420 53 9		375	249 8-10 VA	40/ V2A	5417910	5311 55 1		355
						249 8-10 VA-OT	40/ V2A	5835349	5311 55 4		301
204 KL-1500	/ St	5430575	5430 15 1		316	249 8-10 VA-OT	40/ V2A	5835349	5311 55 4		305
204 KL-1500	/ St	5430575	5430 15 1		375	249 8-10 VA-OT	40/ V2A	5835349	5311 55 4		352
				/pc.		249 8-10 VA-OT	40/ V2A	5835349	5311 55 4		367
204 KS-2000	2000/ St / F	5901457	5430 01 1		316	249 8-10 ZV	44/ Cu	5417859	5311 53 5		355

# Type listing

Structure of the GTIN: Country code **40** Manufacturer code **1219** Individual GTIN **5647589**

Type	Dimensions/Colour/Div.	GTIN	Art. no.	Price	Page	Type	Dimensions/Colour/Div.	GTIN	Art. no.	Price	Page
249 8-10X16 VA	/ V2A	5925446	5311 59 0	/100 pc.	356	264 CU	/ Cu	5420378	5316 55 3	/100 pc.	367
249 B ALU	44/ Al	5452058	5311 71 3		355	267	/ St / FT	5420132	5316 30 8		365
249 B ST	40/ FT	5451990	5311 70 5	306	353	267 VA	/ V2A	5420194	5316 32 4	366	
249 VA-OT	/ V2A	5693789	5311 57 3	368	321	269 8-10	/ Zn / G	5420439	5317 01 0	363	
249 VA-OT	/ V2A	5693789	5311 57 3	368	321	269 MS	/ Zn / Cu	5420491	5317 05 3	363	
250	/ St / FT	5418696	5312 90 6	360	321	270 8-10 CU	/ Cu	5420675	5317 25 8	364	
250	/ St / FT	5418696	5312 90 6	360	321	270 8-10 FT	/ St / FT	5420552	5317 20 7	363	
250 A-BO	25/ St / F	5806530	5313 06 6	321	321	270 8-10 VA	/ V2A	5893158	5317 20 8	363	
250 A-FT	40/ St / FT	5740537	5313 01 5	321	321	271 8-10	/ St / FT	5420798	5317 40 1	/100 pc.	364
250 AS-FT	20/ St / FT	5543015	5313 03 1	321	360	271 8-10 VA	/ V2A	5850861	5317 48 1		364
250 A-VA	40/ V2A	5740476	5313 02 3	321	321	271 CU	/ Cu	5420910	5317 45 2	364	
250 V4A	/ V4A	5700876	5312 92 5	360	321	272 14	/ TG / FT	5421092	5318 14 9	363	
250 V4A	/ V4A	5700876	5312 92 5	360	361	272 8	/ TG / FT	5421030	5318 08 4	363	
250 VA	/ V2A	5418757	5312 92 2	360	320	273 8-10	/ St / FT	5420613	5317 22 3	364	
250 VA	/ V2A	5418757	5312 92 2	360	320	273 CU	/ Cu	5420736	5317 27 4	364	
251 8-10	/ St / FT	5417972	5312 03 5	361	320	274 8-10	/ St / FT	5420859	5317 42 8	365	
251 CU	/ Cu	5418030	5312 13 2	361	361	274 CU	/ Cu	5420972	5317 47 9	365	
252 8-10 CU	/ Cu	5418214	5312 41 8	320	320	280 8-10	/ Zn / G	5421276	5320 01 1	368	
252 8-10 CU	/ Cu	5418214	5312 41 8	362	320	280 VK	/ Zn	5421337	5320 05 4	368	
252 8-10 FT	/ St / FT	5418092	5312 31 0	320	320	287	/ Al	5421573	5320 70 4	369	
252 8-10 FT	/ St / FT	5418092	5312 31 0	361	320	287 CU	/ Cu	5421511	5320 69 0	369	
252 8-10 V4A	/ V4A	5700869	5312 31 8	320	362	288 DIN	/ Al	5421634	5320 71 2	369	
252 8-10 V4A	/ V4A	5700869	5312 31 8	362	320	292 DIN	/ TG / F	5424994	5340 01 2	374	
252 8-10X16 CU	/ Cu	5418276	5312 44 2	362	321	301 CU-100	/ Cu	5426370	5350 70 0	370	
252 8-10X16 CU	/ Cu	5418276	5312 44 2	362	321	301 CU-110	/ Cu	5426431	5350 71 9	370	
252 8-10X16 FT	/ St / FT	5418153	5312 34 5	362	360	301 CU-120	/ Cu	5426493	5350 72 7	370	
252 8-10X16 FT	/ St / FT	5418153	5312 34 5	362	360	301 CU-80	/ Cu	5426257	5350 68 9	370	
252 8-10x16 V4A	/ V4A	5893103	5312 34 6	320	360	301 CU-90	/ Cu	5426318	5350 69 7	370	
252 8-10x16 V4A	/ V4A	5893103	5312 34 6	362	360	301 DIN-100	/ St / FS	5425717	5350 10 7	370	
252 8-10xFL30 FT	/ St / F	5418399	5312 65 5	321	320	301 DIN-110	/ St / FS	5425779	5350 11 5	370	
252 8-10xFL30 FT	/ St / F	5418399	5312 65 5	360	320	301 DIN-120	/ St / FS	5425830	5350 12 3	370	
252 8-10xFL30V4A	/ V4A	5893141	5312 65 6	321	362	301 DIN-80	/ St / FS	5425595	5350 08 5	370	
252 8-10xFL30V4A	/ V4A	5893141	5312 65 6	360	319	301 DIN-90	/ St / FS	5425656	5350 09 3	370	
253 10X16	/ St / F	5418573	5312 80 9	320	361	301 S-100	/ St / FS	5426974	5351 05 7	370	
253 10X16	/ St / F	5418573	5312 80 9	362	361	301 S-120	/ St / FS	5427032	5351 07 3	370	
253 8X8	/ St / F	5418337	5312 60 4	319	361	301 S-AL-100	/ Al	5890652	5351 35 9	370	
253 8X8	/ St / F	5418337	5312 60 4	361	361	301 S-AL-120	/ Al	5890713	5351 37 5	370	
254 DIN 8-10 CU	/ Cu	5419112	5314 13 5	361	319	301 S-CU-100	/ Cu	5427216	5351 45 6	371	
254 DIN 8-10 FT	/ St / FT	5418993	5314 03 8	361	319	301 S-CU-120	/ Cu	5427278	5351 47 2	371	
255 30	52/ St / FT	5419174	5314 51 8	319	319	301 S-VA-100	/ V2A	5427094	5351 25 1	371	
255 A-FL30 FT	60/ St / FT	5419235	5314 53 4	319	319	301 S-VA-120	/ V2A	5427155	5351 28 6	371	
256 A-DIN 30 FT	60/ St / FT	5419471	5314 65 8	319	319	301 V	/ St / FS	5426790	5350 86 7	369	
256 A-DIN 30 V4A	60/ V4A	5893080	5314 65 9	319	319	301 V-CU	/ Cu	5426851	5350 88 3	370	
256 A-DIN 30 VA	60/ V2A	5925873	5314 72 0	319	319	301 V-VA	/ V2A	5426912	5350 90 5	370	
256 A-DIN 40 FT	80/ St / FT	5419532	5314 66 6	319	319	303 DIN-1	/ St / FT	5399971	5102 11 1	371	
256 DIN 30 FT	60/ St / FT	5419297	5314 61 5	319	319	303 DIN-1 1/2	/ St / FT	5400097	5102 15 4	371	
256 DIN 30 V4A	60/ V4A	5893097	5314 61 6	319	319	303 DIN-1 1/4	/ St / FT	5400035	5102 13 8	371	
256 DIN 40 FT	80/ St / FT	5419358	5314 62 3	319	319	303 DIN-1/2	/ St / FT	5399858	5102 07 3	371	
259 8-10	/ TG / FT	5419716	5315 50 6	358	319	303 DIN-2	/ St / FT	5400158	5102 19 7	371	
259 A FT	/ St / FT	5740414	5315 51 4	322	319	303 DIN-2 1/2	/ St / FT	5400219	5102 21 9	371	
259 A FT 8-OT	/ St / FT	5737070	5315 51 7	368	319	303 DIN-3	/ St / FT	5400271	5102 23 5	371	
259 A ST	/ St	5237198	5315 55 7	322	319	303 DIN-3 1/2	/ St / FT	5400332	5102 25 1	371	
259 A VA	/ V2A	5740353	5315 52 2	322	319	303 DIN-3/4	/ St / FT	5399919	5102 08 1	371	
260 8	/ Zn / G	5419839	5315 70 0	359	322	303 DIN-3/8	/ St / FT	5399797	5102 05 7	371	
260 8-10 MS	/ CuZn / Cu	5419778	5315 65 4	359	368	303 DIN-4	/ St / FT	5400394	5102 27 8	371	
262	/ St / FT	5419891	5316 01 4	366	322	311 N-ALU 16	/ Al	5631392	3049 34 5	326	
262 A-DIN CU	/ Cu	5420071	5316 25 1	366	322	311 N-ALU 16	/ Al	5631392	3049 34 5	374	
262 A-DIN FT	/ St / FT	5420019	5316 21 9	366	359	311 N-ALU 8-10		5631576	3049 25 6	326	
262 CU	/ Cu	5419952	5316 15 4	366	359	311 N-ALU 8-10		5631576	3049 25 6	374	
262 ZM	/ St / FT	5818359	5316 17 0	366	366	311 N-CU 16	/ Cu	5631514	3049 30 2	326	
264	/ St / F	5420316	5316 51 0	367	366	311 N-CU 16	/ Cu	5631514	3049 30 2	374	
					366	311 N-CU 8-10	/ Cu	5631699	3049 20 5	326	
					366	311 N-CU 8-10	/ Cu	5631699	3049 20 5	374	
					366	311 N-VA 16	/ V2A	5631453	3049 32 9	326	
					366	311 N-VA 16	/ V2A	5631453	3049 32 9	374	
					366	311 N-VA 8-10	/ V2A	5631637	3049 22 1	326	
					366	311 N-VA 8-10	/ V2A	5631637	3049 22 1	374	
					367	319 10	/ TG / F	5421931	5325 31 5	367	

02\_TBS\_Masterkatalog\_Länder\_2012 / en / 10/04/2012 (LLEXP01\_433)

# Type listing

Type	Dimensions/Colour/Div.	GTIN	Art. no.	Price	Page	Type	Dimensions/Colour/Div.	GTIN	Art. no.	Price	Page
319 8	/ TG / F	5421870	5325 30 7	/100 pc.	367	910 N 6x60 GRW	660/ PA	5228974	2349 07 8	/100 pc.	378
324 S-CU	/ Cu	5422532	5326 33 8		368	910 N 8x40 GRW	840/ PA	5229032	2349 08 6		378
324 S-FT	/ St / FT	5422419	5326 30 3		368	925 1	7031,7-33,7 / St / G	5385455	5040 11 6		304
324 S-VA	/ V2A	5422471	5326 31 1		368	925 1 1/2	8846,3-48,3 / St / G	5385578	5040 15 9		304
330 K	/ PA	5401599	5201 10 1		336	925 1 1/4	8140,4-42,4 / St / G	5385516	5040 13 2		304
356 100	10010	5230595	2360 10 1	/pc.	326	925 1/2	5619,3-21,3 / St / G	5385332	5040 07 8		304
356 100	10010	5230595	2360 10 1		377	925 1/4	4811,5-13,5 / St / G	5385219	5040 03 5		304
356 50	5010	5230533	2360 05 5		326	925 3/4	6224,9-26,9 / St / G	5385394	5040 09 4		304
356 50	5010	5230533	2360 05 5		377	925 3/8	5215,2-17,2 / St / G	5385271	5040 05 1		304
364	297/ St / FT	5244219	3051 01 3		378	927 0	/ CuZn / N	5388517	5057 50 7		303
366 35	35/ St / FT	5388876	5059 35 6	/100 pc.	326	927 1	/ V2A	5388579	5057 51 5		303
366 50	50/ St / FT	5389057	5059 49 6		326	927 2	/ V2A	5388630	5057 52 3		303
370 H	55/ St / FT	5382690	5025 20 6		325	927 2 6-K	/ V2A	5699651	5057 59 9		392
470 4-16	/ CuZn / N	5389231	5064 01 5		306	927 4	/ V2A	5388692	5057 55 8		303
480 180	5412571	5240 03 4		/pc.	288	927 BAND-VA	230,3/ V2A	5805458	5057 92 2	/100 m	303
480 250	5412755	5240 07 7			288	927 SCH-K-VA	/ V2A	5805519	5057 93 0	/100 pc.	303
480 350	5412694	5240 06 9			288	928	240/ CuZn / N	5385936	5040 50 7		304
481	5412816	5240 08 5			288	937 50	100/ St / FT	5385998	5043 01 8		306
482	5412632	5240 05 0			289	939	150/ St / G	5386056	5043 10 7		306
484 M12	13/ St / F	5412991	5240 22 0		288	942 11	448-11 / Cu / N	5384557	5038 01 4		304
484 M16	17/ St / F	5413059	5240 23 9		288	942 15	5013-15 / Cu / N	5384618	5038 03 0		304
484 M20	21/ St / F	5413110	5240 24 7		288	942 18	5216-18 / Cu / N	5384670	5038 05 7		304
484 M24	25/ St / F	5413172	5240 25 5		288	942 22	5519-22 / Cu / N	5384731	5038 07 3		304
485 M10	11/ St / F	5413233	5240 30 1		288	942 28	6324-28 / Cu / N	5384793	5038 08 1		304
485 M12	13/ St / F	5413295	5240 32 8		288	942 35	7130-35 / Cu / N	5384854	5038 11 1		304
485 M16	17/ St / F	5413356	5240 33 6		288	942 43	8139-43 / Cu / N	5384915	5038 13 8		304
485 M20	21/ St / F	5413417	5240 34 4		288	942 49	8644-49 / Cu / N	5384977	5038 15 4		304
555 7.6x380 SWUV	7.6 x 380 102/ PA	5896920	2332 78 4	/100 pc.	393	950 Z 1	6631,5-34,5 / Zn / G	5386353	5050 11 1		304
708 30 HG	52/ St / G	5383659	5030 23 4		325	950 Z 1 1/2	8446,5-49,5 / Zn / G	5386476	5050 15 4		304
708 30 SP	52/ St / G	5383413	5030 02 1		325	950 Z 1 1/4	7840,5-43,5 / Zn / G	5386414	5050 13 8		304
708 40 HG	52/ St / G	5383710	5030 24 2		325	950 Z 1 3/4	8851-54 / Zn / G	5386537	5050 17 0		304
710 30	52/ St / G	5383055	5028 03 5		325	950 Z 1/2	5420-22,5 / Zn / G	5386230	5050 07 3		304
710 40	62/ St / G	5383116	5028 04 3		325	950 Z 1/4	4512-14 / Zn / G	5386117	5050 03 0		304
733 16 VA	14-16 6,5 x 10/ V2A	5116714	1362 01 1		352	950 Z 2	9658,5-61,5 / Zn / G	5386599	5050 19 7		304
733 21 VA	19-21 6,5 x 10/ V2A	5116837	1362 04 6		354	950 Z 3/4	6125-28 / Zn / G	5386292	5050 08 1		304
831 30	54/ St / FT	5383833	5032 03 2		324	950 Z 3/8	5015,5-17,5 / Zn / G	5386179	5050 05 7		304
831 30 M6	54/ St / FT	5383956	5032 23 7		324	951	120/ V2A	5386650	5051 50 9		305
831 40	65/ St / FT	5383895	5032 04 0		324	952 Z 1	7730,5-33,5 / St / FT	5386957	5052 11 4		305
831 40 M6	65/ St / FT	5384014	5032 24 5		324	952 Z 1 1/2	9445,5-48,5 / St / FT	5387077	5052 15 7		305
832 30	55/ St / FT	5384137	5032 53 9		324	952 Z 1 1/4	8739,5-42,5 / St / FT	5387015	5052 13 0		305
832 40	65/ St / FT	5384199	5032 54 7		324	952 Z 1/2	6518,5-21,5 / St / FT	5386834	5052 07 6		305
833 35	60/ St / FT	5384434	5033 03 9		324	952 Z 2	10557-60 / St / FT	5387190	5052 18 1		305
835	/ St / FT	5433750	5033 20 9		324	952 Z 3/4	7124-27 / St / FT	5386896	5052 09 2		305
853 200	200/ Cu	5885573	5331 00 8		369	985 M6 25	25,4,3/ St / G	5250395	3133 02 8		378
853 300	300/ Cu	5423379	5331 01 3		369	985 M6 35	35,4,3/ St / G	5250456	3133 03 6		378
853 400	400/ Cu	5885580	5331 01 7		369	985 M8 35	3510/ St / G	5250579	3133 23 0		378
856	/ Cu	5423430	5331 50 1		369	1801 AH	Grey/ PS	5378617	5015 70 7	/pc.	297
910 N 10x50 GRW	1050/ PA	5229155	2349 10 8		378	1801 KL1	212/ CuZn	5378730	5015 72 3		297
910 N 12x60 GRW	1260/ PA	5229216	2349 12 4		378	1801 KL2	430/ CuZn	5378976	5015 80 4		297
910 N 5x25 GRW	525/ PA	5228851	2349 04 3		378	1801 KL3	645/ CuZn	5379034	5015 81 2		297
910 N 6x30 GRW	630/ PA	5228912	2349 05 1		378	1801 RK25	/ St / G	5378853	5015 75 8		296
					378	1801 RK30	/ St / G	5378792	5015 73 1		296
					378	1801 RK40	/ St / G	5455837	5015 77 4		297
					378	1801 RK95	/ St / G	5378914	5015 76 6		296
					378	1801 SCH	Grey/ PS	5378679	5015 71 5		297
					378	1801 VDE	Grey/ CuZn	5378556	5015 65 0		296
					378	1802 10 CU	40/ Cu	5002260	5015 84 2		301
					378	1802 10 VA	40/ V2A	5002284	5015 86 6		301
					378	1802 12 CU	40/ Cu	5699354	5015 84 4		301
					378	1802 14 CU	40/ Cu	5699361	5015 84 7		301
					378	1802 20 CU	40/ Cu	5699408	5015 84 9		301
					378	1802 5 CU	40/ Cu	5002253	5015 83 0		301
					378	1802 5 VA	40/ V2A	5002277	5015 85 4		301
					378	1802 6 CU	40/ Cu	5699330	5015 83 2		301
					378	1802 8 CU	40/ Cu	5699347	5015 83 6		301
					378	1802 AH 10	/ V2A	5033677	5015 88 4		301
					378	1802 AH 5	/ V2A	5033615	5015 88 0		301
					378	1802 KL	/ V2A	5033738	5015 89 0		301
					378	1804	/ CuZn	5378495	5015 55 3		299
					378	1804 AP	/ PE	5477839	5015 55 7		299

02\_TBS\_Masterkatalog\_Länder\_2012 / en / 10/04/2012 (LLEExport\_01433)



# Type listing

Structure of the GTIN: Country code **40** Manufacturer code **1219** Individual GTIN **5647589**

Type	Dimensions/Colour/Div.	GTIN	Art. no.	Price	Page	Type	Dimensions/Colour/Div.	GTIN	Art. no.	Price	Page
1804 UP	/ CuZn	5378433	5015 54 5	/pc.		2710 20	84/ St / FT	5372370	5001 21 8	/pc.	318
						2710 25	89/ St / FT	5372431	5001 22 6		318
1805 2 FT	200110/ St / FT	5379096	5016 02 9		302						
1805 2 FT	200110/ St / FT	5379096	5016 02 9		323	2730 20 FT	84/ St / FT	5372554	5001 40 4		318
1805 2 VA	200110/ V4A	5922216	5016 09 6		323	2730 20 VA	84/ V2A	5635475	5001 36 6		318
1805 2 VA	200110/ V4A	5922216	5016 09 6		302	2730 25 FT	89/ St / FT	5372615	5001 41 2		318
1805 4 FT	302212/ St / FT	5379157	5016 03 7		302						
1805 4 FT	302212/ St / FT	5379157	5016 03 7		323	2745 20 MS	/ CuZn / Cu	5372851	5001 56 0		318
1805 4 VA	302212/ V4A	5800354	5016 11 8		323	2745 20 MS	/ CuZn / Cu	5372851	5001 56 0		374
1805 4 VA	302212/ V4A	5800354	5016 11 8		302						
1805 6 FT	404314/ St / FT	5379218	5016 04 5		302	2760 20 FT	101/ St / FT	5372912	5001 64 1		318
1805 6 FT	404314/ St / FT	5379218	5016 04 5		323	2760 20 V4A	101/ V4A	5862697	5001 63 3		318
1805 6 VA	404314/ V4A	5922278	5016 12 6		323	2760 20 VA	101/ V2A	5635239	5001 61 7		318
1805 6 VA	404314/ V4A	5922278	5016 12 6		302	2760 25 FT	110/ St / FT	5372974	5001 66 8		318
						2760 25 V4A	110/ V4A	5901259	5001 67 2		318
1807	/ Al	5379270	5016 14 2		323					/pc.	
						2760 B-20 FT	101/ St / FT	5754879	5001 74 9		318
1808	/ CuZn	5378075	5015 01 4		299	2760 B-20 VA	101/ V2A	5752653	5001 62 5		318
1809	Grey/ CuZn	5378259	5015 07 3		297					/100 pc.	
1809 30 AH	Grey/ PS	5800118	5015 20 0		298	5000	/ St / F	5415695	5304 00 8		356
1809 A	Black/ V2A	5959427	5015 11 1		300						
1809 BG	Grey/ CuZn	5378372	5015 50 2		298	5001 DIN-FT	/ St / FT	5415879	5304 10 5		356
1809 M	Grey/ CuZn	5378310	5015 08 1		298	5001 DIN-FT+VA	/ St / FT	5858034	5304 10 7		356
1809 UP	/ CuZn	5378198	5015 06 5			5001 N-Cu	/ Cu	5817574	5304 17 2		357
						5001 N-FT	/ St / FT	5817512	5304 16 4		357
1810	/ St / F	5378136	5015 05 7		298	5001 N-VA	/ V2A	5892809	5304 17 6		357
1811	250/ St / FT	5377894	5014 01 8		323	5001 ZN-CU	/ Zn / Cu	5415930	5304 11 3	/100 pc.	356
1811 L	400/ St / FT	5377955	5014 02 6		323						
						5002 DIN-FT	/ St / FT	5416050	5304 20 2		356
1813 DIN	/ St / FT	5378013	5014 21 2		323	5002 N-VA	/ V2A	5892847	5304 27 0		357
1813 KL	/ St / FT	5901938	5014 42 5		322						
1814 FT	/ St / FT	5105015	5014 46 8		322	5003	/ TG / FT	5416234	5304 31 8	/100 pc.	357
1814 ST	/ St	5105077	5014 47 6		322						
						5004 DIN-FT 12	/ TG / FT	5416357	5304 40 7		362
1816 F-1000X1000	/ St / FT	5376996	5009 23 5		317	5004 DIN-FT 20	/ TG / FT	5416418	5304 50 4		362
1816 F-500X1000	/ St / FT	5376934	5009 22 7		317						
1816 F-500X500	/ St / FT	5376873	5009 21 9		317	5005 DIN-FT	/ St / F	5416470	5304 60 1		358
						5005 N-FT	/ St / FT	5817758	5304 66 0		358
1818	/ St / FT	5377719	5012 01 5	/100 pc.	322	5009	/ St / F	5416951	5304 97 0		358
						5010 20 FT	/ St / FT	5503057	5304 52 0		363
1819 20	/ TG / FT	5242710	3041 20 4	/pc.	313						
1819 20BP	/ TG / FT	5242772	3041 21 2		313	5011	/ St / FT	5417071	5304 99 7		322
1819 25	/ TG / FT	5242833	3041 25 5		313	5011	/ St / FT	5417071	5304 99 7		358
1819 25BP	/ TG / FT	5242956	3041 95 6		313						
						5011 VA M10	/ V4A	5629115	5334 93 4		323
1820 20	/ St	5243137	3042 20 0		314	5011 VA M10	/ V4A	5629115	5334 93 4		358
1820 25	/ St	5243199	3042 25 1		314	5011 VA M12	/ V4A	5959663	5334 94 2		323
						5011 VA M12	/ V4A	5959663	5334 94 2		358
2056N SAS 12 VA	8-12 / V2A	5432432	1167 01 4	/100 pc.	306						
2056N SAS 16 VA	12-16 / V2A	5432494	1167 02 2		306					/100 m	
2056N SAS 22 VA	16-22 / V2A	5432555	1167 03 0		306	5052 DIN 20X2.5	20 x 2,5/ St / FT	5680468	5019 34 0		310
2056N SAS 28 VA	22-28 / V2A	5432616	1167 04 9		306	5052 DIN 20X2.5	20 x 2,5/ St / FT	5680468	5019 34 0		330
2056N SAS 8 VA	4-8 / V2A	5432371	1167 00 6		306	5052 DIN 25X3	25 x 3/ St / FT	5694007	5019 34 2		310
						5052 DIN 25X3	25 x 3/ St / FT	5694007	5019 34 2		330
						5052 DIN 30X3	30 x 3/ St / FT	5694014	5019 34 4		310
2066 2M F	25 x 12/ St / F	5046516	1117 02 5	/100 m	306	5052 DIN 30X3	30 x 3/ St / FT	5694014	5019 34 4		330
2066 2M FS	25 x 12/ St / FS	5046578	1117 03 3		306	5052 DIN 30X3.5	30 x 3,5/ St / FT	5680475	5019 34 5		310
						5052 DIN 30X3.5	30 x 3,5/ St / FT	5680475	5019 34 5		330
						5052 DIN 30X3.5	30 x 3,5/ St / FT	5680482	5019 34 7		310
						5052 DIN 30X3.5	30 x 3,5/ St / FT	5680482	5019 34 7		330
2500 20	/ St	5243311	3043 20 7	/pc.	314	5052 DIN 30X4	30 x 4/ St / FT	5680499	5019 35 0		310
2500 25	/ St	5243373	3043 25 8		314	5052 DIN 30X4	30 x 4/ St / FT	5680499	5019 35 0		330
						5052 DIN 40X4	40 x 4/ St / FT	5680505	5019 35 5		310
2510 20	/ St	5717492	3043 31 2		314	5052 DIN 40X4	40 x 4/ St / FT	5680505	5019 35 5		330
						5052 DIN 40X5	40 x 5/ St / FT	5680512	5019 36 0		310
2520 20	/ St	5243793	3043 70 3		314	5052 DIN 40X5	40 x 5/ St / FT	5680512	5019 36 0		330
2520 25	/ St	5243854	3043 75 4		314	5052 V2A 30X3.5	30 x 3,5/ V2A	5800415	5018 50 1		310
						5052 V2A 30X3.5	30 x 3,5/ V2A	5800415	5018 50 1		330
2530 20	/ St	5243557	3043 40 1		314	5052 V4A 30X3.5	30 x 3,5/ V4A	5800477	5018 70 6		310
2530 25	/ St	5243618	3043 45 2		314	5052 V4A 30X3.5	30 x 3,5/ V4A	5800477	5018 70 6		330
						5052 V4A 30X3.5	30 x 3,5/ V4A	5022015	5018 73 0		310
2531 20	/ St	5642312	3043 90 8		314	5052 V4A 30X3.5	30 x 3,5/ V4A	5022015	5018 73 0		330
2535 20	/ St	5453796	3043 91 6		315					/pc.	
2535 25	/ St	5453970	3044 91 2		315						
						5700 A DIN		5400936	5106 02 8		376
2536 20	/ St	5643036	3044 90 4		315	5700 DIN		5400875	5106 00 1		376
2536 25	/ St	5642978	3044 83 1		315						
						5800 VA	/ V2A	5900436	5106 14 1		376
						5800 VZ	/ St / FS	5900375	5106 13 3		376

02\_TBS\_Masterkatalog\_Länder\_2012 / en / 10/04/2012 (LLEExport\_01433)

Type	Dimensions/Colour/Div.	GTIN	Art. no.	Price	Page	Type	Dimensions/Colour/Div.	GTIN	Art. no.	Price	Page
5900	/ st	5244813	3059 00 6	/pc.	378	FL 20-CU	20 x 2,5/ Cu	5382331	5021 80 4	/100 m	310
ASP-V11E1 4		5917717	5083 08 7		257	FL 20-CU	20 x 2,5/ Cu	5382331	5021 80 4		330
ASP-V24T 4		5917595	5083 06 0		257						
B 33020	228/ CuZn	6049080	6404 00 6	/100 pc.	306	FLD 110		5578413	5098 64 6	/pc.	270
B 33021	2610/ CuZn	6049202	6404 01 4		306	FLD 12		5578376	5098 60 3		269
						FLD 2-110		5578512	5098 85 9		272
						FLD 2-12		5578444	5098 80 8		271
						FLD 2-24		5578451	5098 81 6		271
						FLD 24		5578383	5098 61 1		269
						FLD 2-48		5578468	5098 82 4		271
C 25-B+C 0		5919391	5095 60 3	/pc.	164	FLD 2-5		5578529	5098 86 7		271
C 25-B+C 0		5919391	5095 60 3		195	FLD 48		5578390	5098 63 0		269
C 25-B+C 1		5542957	5095 60 6		156	FLD 5		5578369	5098 60 0		269
C 25-B+C 1		5542957	5095 60 6		179	FLD 60		5578406	5098 63 8		270
C 25-B+C 1		5542957	5095 60 6		195						
CNS 3-D-D	ENBlack	5952817	5092 70 1		211	FRD 110		5578338	5098 55 7		267
						FRD 12		5578291	5098 50 6		266
						FRD 2-24		5578420	5098 72 7		268
CNS-D-D	ENLight grey	5314837	5092 60 4		211	FRD 24		5578307	5098 51 4		266
						FRD 24 HF		5578352	5098 57 5		265
DLS-BS		5685333	5082 38 2		251	FRD 2-5		5578437	5098 79 4		268
						FRD 48		5578314	5098 52 2		266
DS-7 16 M/W		5030881	5093 17 1		247	FRD 5		5578284	5098 49 2		266
						FRD 5 HF		5578345	5098 57 1		265
DS-BNC M/M		5391098	5093 26 0		246						
DS-BNC M/W		5391036	5093 25 2		245	FS-V20		5397458	5099 80 3		289
DS-BNC W/W		5390978	5093 23 6		245						
DS-F M/W		5022732	5093 27 5		247	ISAV1000R	/ GFK	5004608	5408 84 9		386
DS-F W/W		5022619	5093 27 2		247	ISAV1000W	/ GFK	5009733	5408 85 2		386
DS-N M/W		5805991	5093 99 6		246					/100 m	
DS-N W/W		5962243	5093 98 8		246	isCon 750 LGR	Light grey	5888123	5407 99 5		388
						isCon 750 LGR	Light grey	5888154	5407 99 7		388
DS-SMA W/W		5867050	5093 27 7		247	isCon 750 SW	Black	5674573	5408 00 2		388
						isCon 750 SW	Black	5674627	5408 00 4		388
DS-TNC M/W		5087250	5093 27 0		246	isCon 750 SW	Black	5854265	5408 00 6		388
FC-D	ENPure white	5035053	5092 80 0		210	isCon AP1-16 VA	/ V2A	5674696	5408 02 6	/pc.	392
						isCon AP2-16 VA	/ V2A	5674702	5408 02 8		392
FC-ISDN-D	ENPure white	5047223	5092 81 2		211	isCon connect	/ V2A	5674689	5408 02 2		388
						isCon cut		5674641	5408 01 1		388
FC-RJD	ENPure white	5047254	5092 82 8		211	isCon DH	23-26 / GFK	5674863	5408 04 3		390
FC-SAT-D	ENPure white	5035176	5092 81 6		210	isCon EPPA 004	140200/ Z-PP-P	5813781	5408 06 0	/100 pc.	
FC-TAE-D	ENPure white	5035237	5092 82 4		210	isCon H 26 VA	/ V2A	5872696	5408 06 4	/pc.	389
FC-TV-D	ENPure white	5035114	5092 80 8		210	isCon H VA	/ V2A	5699668	5408 05 6		389
						isCon H280 26 PA	Light grey/ PA	5872757	5408 07 2		390
FDB-2 24-M	3222	5683339	5098 38 0		282	isCon H280 26 VA	/ V2A	5872764	5408 07 4		390
FDB-2 24-N	3222	5683384	5098 39 0		282	isCon H280 PA	Black/ PA	5674887	5408 04 9		390
FDB-3 24-M	3222	5683346	5098 38 2		282	isCon H280 VA	/ V2A	5674870	5408 04 7		390
FDB-3 24-N	3222	5683391	5098 39 2		282	isCon HS 26 PA	Light grey/ PA	5872702	5408 06 6		389
						isCon HS 26 VA	/ V2A	5872740	5408 06 8		389
						isCon HS PA	Black/ PA	5674917	5408 05 4		389
						isCon HS VA	/ V2A	5674726	5408 05 2		389
F-FIX-10		5070054	5403 10 3	/100 pc.	333	isCon HWS	/ PS	5813774	5408 05 8		
F-FIX-10B		5070061	5403 11 0		333	isCon IN connect	M16/ V2A	5864172	5408 02 4		391
F-FIX-132	110/ V2A	5613572	5403 33 0	/pc.	336	isCon IN PAE	49,9/ AI	5871569	5408 03 1		391
						isCon PAE	/ V2A	5674719	5408 03 6		388
F-Fix-132-300	300/ V2A	5813903	5403 33 3		336	isCon stripper	23-26	5674634	5408 00 9		388
F-FIX-16		5548713	5403 20 0	/100 pc.	333	isFang 3B-100	1000/ V2A	5670148	5408 96 8		337
F-FIX-16B		5110637	5403 20 5		333	isFang 3B-100	1000/ V2A	5670148	5408 96 8		391
F-FIX-B10	/ PP	5070085	5403 12 4		334	isFang 3B-100 AL	1000/ AI	5802433	5408 96 6		337
F-FIX-B10	/ PP	5070085	5403 12 4		385	isFang 3B-100 AL	1000/ AI	5802433	5408 96 6		391
F-FIX-B16	/ PP	5548959	5403 23 5		333	isFang 3B-100-A	1026/ V2A	5859550	5408 93 0		337
F-FIX-B16	/ PP	5548959	5403 23 5		384	isFang 3B-100-A	1026/ V2A	5859550	5408 93 0		391
F-FIX-B16 3B	25/ PP	5926320	5403 23 8		338	isFang 3B-150	1500/ V2A	5674931	5408 96 9		337
F-FIX-B16 3B	25/ PP	5926320	5403 23 8		392	isFang 3B-150	1500/ V2A	5674931	5408 96 9		391
						isFang 3B-150 AL	1500/ AI	5802440	5408 96 7		337
F-FIX-BASIS	/ PP	5034933	5403 32 4	/pc.	332	isFang 3B-150 AL	1500/ AI	5802440	5408 96 7		391
F-FIX-JUNIOR	1000/ AI	5034872	5403 30 8		332	isFang 3B-150-A	1500/ V2A	5859567	5408 93 2		337
						isFang 3B-150-A	1500/ V2A	5859567	5408 93 2		391
F-FIX-KL	/ V2A	5548775	5403 21 9		334	isFang 3B-G1	270/ V2A	5674948	5408 97 1		338
F-FIX-S10		5070078	5403 11 7		334	isFang 3B-G1	270/ V2A	5674948	5408 97 1		392
F-FIX-S10		5070078	5403 11 7		384	isFang 3B-G2	340/ V2A	5674979	5408 97 2		338
F-FIX-S16		5548898	5403 22 7		333	isFang 3B-G2	340/ V2A	5674979	5408 97 2		392
F-FIX-S16		5548898	5403 22 7		338	isFang 3B-G3	430/ V2A	5674986	5408 97 3		338
F-FIX-S16		5548898	5403 22 7		384	isFang 3B-G3	430/ V2A	5674986	5408 97 3		392
F-FIX-S16		5548898	5403 22 7		392	isFang 4000	1240/ GFK	5670056	5408 94 2		337
						isFang 4000	1240/ GFK	5670056	5408 94 2		391

# Type listing

Structure of the GTIN: Country code **40**      Manufacturer code **1219**      Individual GTIN **5647589**

Type	Dimensions/Colour/Div.	GTIN	Art. no.	Price	Page	Type	Dimensions/Colour/Div.	GTIN	Art. no.	Price	Page
isFang 4000 AL	1240/ GFK	5785330	5408 94 3	/pc.	337	MB 1		5415732	5096 64 8	/pc.	205
isFang 4000 AL	1240/ GFK	5785330	5408 94 3		391	MB 1+FS		5415749	5096 64 9		165
isFang 6000	3340/ GFK	5670063	5408 94 6		337	MB 1+FS		5415749	5096 64 9		196
isFang 6000	3340/ GFK	5670063	5408 94 6		391	MB 1+FS		5415749	5096 64 9		205
isFang 6000 AL	3340/ GFK	5785347	5408 94 7		337	MB 1+NPE		5415770	5096 65 0		165
isFang 6000 AL	3340/ GFK	5785347	5408 94 7		391	MB 1+NPE		5415770	5096 65 0		196
isFang IN 4000	1325/ GFK	5871613	5408 93 4		338	MB 1+NPE		5415770	5096 65 0		205
isFang IN 4000	1325/ GFK	5871613	5408 93 4		393	MB 1+NPE+FS		5415787	5096 65 1		165
isFang IN 6000	3325/ GFK	5871620	5408 93 6		338	MB 1+NPE+FS		5415787	5096 65 1		196
isFang IN 6000	3325/ GFK	5871620	5408 93 6		393	MB 1+NPE+FS		5415787	5096 65 1		205
isFang IN-A 4000	1325/ GFK	5871668	5408 93 8		337						
isFang IN-A 4000	1325/ GFK	5871668	5408 93 8		390	MB 2		5415794	5096 65 3		165
isFang IN-A 6000	3325/ GFK	5871675	5408 94 0		337	MB 2		5415794	5096 65 3		196
isFang IN-A 6000	3325/ GFK	5871675	5408 94 0		390	MB 2		5415794	5096 65 3		205
isFang TR100	40/ V2A	5670100	5408 95 6		339	MB 2+FS		5415800	5096 65 4		165
isFang TR100	40/ V2A	5670100	5408 95 6		393	MB 2+FS		5415800	5096 65 4		196
isFang TR100 100	100/ V2A	5849360	5408 95 5		339	MB 2+FS		5415800	5096 65 4		205
isFang TR100 100	100/ V2A	5849360	5408 95 5		394	MB 2+NPE		5067481	5096 65 5		165
isFang TR100 200	200/ V2A	5849391	5408 95 7		339	MB 2+NPE		5067481	5096 65 5		196
isFang TR100 200	200/ V2A	5849391	5408 95 7		394	MB 2+NPE		5067481	5096 65 5		205
isFang TR100 300	300/ V2A	5849407	5408 95 9		339	MB 2+NPE+FS		5067498	5096 65 7		165
isFang TR100 300	300/ V2A	5849407	5408 95 9		394	MB 2+NPE+FS		5067498	5096 65 7		196
isFang TS40-50	40/ V2A	5670117	5408 95 8		339	MB 2+NPE+FS		5067498	5096 65 7		205
isFang TS40-50	40/ V2A	5670117	5408 95 8		394						
isFang TS50-60	30/ V2A	5670124	5408 96 0			MB 3		5067504	5096 66 5		165
isFang TS50-60	30/ V2A	5670124	5408 96 0		339	MB 3		5067504	5096 66 5		196
isFang TS50x50	30/ V2A	5670131	5408 96 4			MB 3		5067504	5096 66 5		205
isFang TS50x50	30/ V2A	5670131	5408 96 4		339	MB 3+FS		5067535	5096 66 7		165
isFang TW200	300/ V2A	5670094	5408 95 4		338	MB 3+FS		5067535	5096 66 7		196
isFang TW200	300/ V2A	5670094	5408 95 4		393	MB 3+FS		5067535	5096 66 7		205
isFang TW30	30/ V2A	5670087	5408 95 2		338	MB 3+NPE		5067542	5096 66 9		165
isFang TW30	30/ V2A	5670087	5408 95 2		393	MB 3+NPE		5067542	5096 66 9		196
isFang TW80	80/ V2A	5670070	5408 95 0		338	MB 3+NPE		5067542	5096 66 9		205
isFang TW80	80/ V2A	5670070	5408 95 0		393	MB 3+NPE+FS		5067559	5096 67 1		165
						MB 3+NPE+FS		5067559	5096 67 1		196
ISO-A-1030	1080/ AI	5770497	5408 82 0		387	MB 3+NPE+FS		5067559	5096 67 1		205
ISO-A-500	500/ AI	5542773	5408 80 6		387						
ISO-A-800	800/ AI	5542834	5408 81 4		387	MB 4		5067566	5096 68 0		165
						MB 4		5067566	5096 68 0		196
						MB 4		5067566	5096 68 0		205
ISOLAB	D/GB	5921738	5096 81 2		292	MB 4+FS		5067597	5096 68 2		165
KB MB		5709350	5089 66 0		206	MB 4+FS		5067597	5096 68 2		196
KB MB		5709367	5089 66 2		206						205
						MB 50-3+NPE		5425144	5096 67 5		152
KOAX B-E2 MF-C		5684916	5082 41 2		250	MB 50-3+NPE+FS		5425151	5096 67 7		152
KOAX B-E2 MF-F		5684855	5082 42 0		250						
						MB25-3+NPE		5871200	5096 67 2		191
KoaxB-E2 FF-F		5685074	5082 42 2		251	MB25-3+NPE+FS		5871248	5096 67 3		191
LC 63		5509899	5096 97 0		143	MB-FS		5813484	5096 69 3		
						MB-FS		5813484	5096 69 3		164
						MB-FS		5813484	5096 69 3		197
LE ERDER FT	1000/ St / FT	5018001	5000 29 7		312						
LE ERDER FT	1500/ St / FT	5617358	5000 30 0		312	MB-SG	Blue/ PA	5616375	5096 69 5		
LE ERDER V4A	1500/ V4A	5708834	5000 33 5		312	MB-SG	Blue/ PA	5616375	5096 69 5		164
						MB-SG	Blue/ PA	5616375	5096 69 5		206
LE HAMMER-AC	/ St	5111641	3043 61 8		315	MC 125-B NPE		5966449	5096 86 3		140
LE HAMMER-B	/ St	5087137	3043 61 4		315						
LE HAMMER-B-II	/ St	5421627	3043 62 8		315	MC 50-B 0 VDE		5480730	5096 82 0		142
LE HAMMER-H	/ St	5087076	3043 61 0		315	MC 50-B 0-OS		5051428	5096 82 5		142
LE HAMMER-SDS-M	/ St	5111160	3043 60 2		315	MC 50-B 3		5077046	5096 87 6		141
LE HAMMER-W	/ St	5617419	3043 60 6		315	MC 50-B 3+1		5077084	5096 87 8		140
						MC 50-B U VDE		5480792	5096 83 9		143
						MC 50-B VDE		5966388	5096 84 7		141
LE KOPF	/ St / FT	5617297	3042 30 8		313	MC 50-B-OS		5051411	5096 85 1		141
LE SPITZE	/ St / FT	5617235	3041 40 9		313	MC V3	/ Cu	5531135	5096 88 4		143
						MC V4	/ Cu	5531197	5096 88 6		143
LFC		5425182	5096 78 6		292	MCD 125-B NPE		5541394	5096 86 5		136
						MCD 50-B		5541158	5096 84 9		137
LSA-A-LEI	Grey	5525134	5084 00 8		241	MCD 50-B 0		5544517	5096 82 2		142
LSA-BF-180		5525370	5084 02 4		242	MCD 50-B 0-OS		5051473	5096 82 7		142
LSA-BF-24		5525431	5084 02 8		242	MCD 50-B 3		5077077	5096 87 7		137
LSA-B-MAG		5525318	5084 02 0		241	MCD 50-B 3+1		5077091	5096 87 9		136
LSA-E		5525493	5084 03 2		242	MCD 50-B 3+1-OS		5288299	5096 83 6		136
LSA-E-LEI	Red	5525257	5084 01 6		241	MCD 50-B 3+1-VG		5362036	5096 87 5		138
LSA-G	Light grey/ PA	5110750	5084 04 8		243	MCD 50-B 3-OS		5288282	5096 83 5		137
LSA-M	/ St	5525554	5084 03 6		242	MCD 50-B 3-VG		5362029	5096 87 4		139
LSA-T-LEI	White	5525196	5084 01 2		241	MCD 50-B-OS		5051466	5096 85 2		137
LSA-TOOL		5525615	5084 04 0		243						
MB 1		5415732	5096 64 8		165	MDP-2 D-12-T-10		5787372	5098 41 5		278
MB 1		5415732	5096 64 8		196	MDP-2 D-24-T		5406860	5098 42 2		275
						MDP-2 D-24-T-10		5787389	5098 42 5		279

02\_TBS\_Masterkatalog\_Länder\_2012 / en / 10/04/2012 (LLExpert\_01433)

Type	Dimensions/Colour/Div.	GTIN	Art. no.	Price	Page	Type	Dimensions/Colour/Div.	GTIN	Art. no.	Price	Page
MDP-2 D-48-T		5406891	5098 44 2	/pc.	276	RD 8-FT	/ St / FT	5381556	5021 08 1	/100 m	330
MDP-2 D-5-T		5406839	5098 40 4		274	RD 8-PVC	Cream8/ Al	5067474	5021 33 2		311
MDP-3 D-24-T		5406877	5098 42 7		275	RD 8-PVC	Cream8/ Al	5067474	5021 33 2		331
MDP-3 D-48-T		5406907	5098 44 6		276	RD 8-V2A	/ V2A	5680529	5021 23 5		311
MDP-3 D-5-T		5406846	5098 40 7		274	RD 8-V2A	/ V2A	5680529	5021 23 5		331
MDP-4 D-12-T-10		5773610	5098 41 9		278	RD 8-V4A	/ V4A	5680574	5021 64 4		311
MDP-4 D-24-EX		5848523	5098 43 2		284	RD 8-V4A	/ V4A	5680574	5021 64 4		331
MDP-4 D-24-T		5406884	5098 43 1		275						
MDP-4 D-24-T-10		5625131	5098 43 3		279						
MDP-4 D-48-EX		5848530	5098 45 2		284						
MDP-4 D-48-T		5406914	5098 45 0		276	RJ11-TELE 4-C		5680536	5081 92 0	/pc.	237
MDP-4 D-5-EX		5848516	5098 41 2		284	RJ11-TELE 4-C		5680536	5081 92 0		238
MDP-4 D-5-T		5406853	5098 41 1		274	RJ11-TELE 4-F		5680413	5081 93 9		238
MDP-4 D-5-T-10		5625124	5098 41 3		277						
				/VPE		RJ45 S-ATM 8-F		5462439	5081 79 3		250
						RJ45 S-E100 4-B		5239956	5081 72 6		252
MK-B		5461111	5091 32 2		293	RJ45 S-E100 4-C		5239895	5081 73 4		252
MK-B		5461111	5091 32 2		376	RJ45 S-E100 4-F		5239833	5081 74 2		252
						RJ45-ISDN 4-C-G		5889458	5081 54 8		239
						RJ45S-V24T 4-F		5502630	5081 64 5		253
				/100 pc.		RJ45S-V24T 8-F		5502692	5081 64 7		253
M-Quick M25 SW	Jet black 20-25 / PA	5505396	2153 78 7		390	RJ45-TELE 4-C		5791119	5081 96 3		238
M-Quick M32 LGR	Light grey 25-32 / PA	5741671	2153 73 4		390	RJ45-TELE 4-F		5791058	5081 97 1		238
				/pc.						/100 pc.	
ND-CAT6A/EA		5614364	5081 80 0		250	RK-FIX	/ St / FT	5433682	5316 45 0		365
				/VPE		RK-FIX CU	/ V2A / Cu	5433736	5316 46 8		365
						RK-FIX VA	/ V2A	5433729	5316 45 9		365
PCS		5461296	5091 43 8		293					/100 m	
PCS		5461296	5091 43 8		376						
				/pc.		S 11-CU	10,5/ Cu	5836209	5021 65 4		
PCS-CS-D	EN	5461654	5091 68 3		293	S 11-CU	10,5/ Cu	5836209	5021 65 4		
PCS-CS-D	EN	5461654	5091 68 3		377						
PCS-CS-GB	GB	5896111	5091 69 1		293	S 9-CU	9/ Cu	5382218	5021 65 0		
PCS-CS-GB	GB	5896111	5091 69 1		377	S 9-CU	9/ Cu	5382218	5021 65 0		
				/VPE							
PCSH		5461470	5091 52 7		293					/pc.	
PCSH		5461470	5091 52 7		377						
				/pc.		SC-TELE 4-C-G		5834793	5081 68 8		237
PS 2-B+C/TT+TNS		5759782	5089 74 8		167	SD09-V11 9		5916277	5080 06 1		256
						SD09-V24 9		5915973	5080 05 3		255
PS3-B+C TNC		5405528	5089 75 4		168						
PS3-B+C TNC+FS		5405535	5089 75 6		168	SD15-V24 15		5916031	5080 15 0		255
PS3-B+C-320		5806813	5089 75 5		168						
PS3-B+C-320+FS		5816614	5089 75 7		168	SD25-V11 25		5916390	5080 28 2		256
PS3-VA TNC		5405566	5089 76 8		170	SD25-V24 25		5916215	5080 27 4		255
PS3-VA TNC+FS		5405580	5089 77 5		170						
PS4-B+C TNS+FS		5405559	5089 76 3		167	SD-Fix	/ V2A	5670735	5403 33 5		335
PS4-B+C TT+TNS		5405542	5089 76 1		167						
PS4-VA TT+FS		5405597	5089 77 7		169						
PS4-VA TT+TNS		5405573	5089 77 0		169						
				/100 pc.		SQ M6	Light grey M6/ PC	5016069	2146 50 9		389
P-TK		5017387	5086 01 9		207						
P-TK+SAT		5017448	5086 02 3		207	SQ PP	630/ PA	5016182	2351 70 6		389
P-TK+TV		5017509	5086 02 7		207						
				/100 m		SQ-20 SW	Jet black 23/ PP	5655367	2146 16 4		389
						SQ-25 LGR	Light grey 26/ PA	5595717	2146 20 7		389
RD 10	/ St / FT	5381617	5021 10 3		310					/pc.	
RD 10	/ St / FT	5381617	5021 10 3		330						
RD 10-ALU	/ Al	5381976	5021 30 8		311	S-UHF M/W		5390732	5093 02 3		245
RD 10-ALU	/ Al	5381976	5021 30 8		331	S-UHF W/W		5390671	5093 01 5		245
RD 10-CU	/ Cu	5382096	5021 50 2		311						
RD 10-CU	/ Cu	5382096	5021 50 2		331	TKS-B		5578277	5097 97 6		265
RD 10-PVC	Black 10/ st / FT	5381730	5021 16 2		310						
RD 10-PVC	Black 10/ st / FT	5381730	5021 16 2		330						
RD 10-V2A	/ V2A	5801375	5021 22 7		311					/100 pc.	
RD 10-V2A	/ V2A	5801375	5021 22 7		331	TrayFix		5738428	5403 10 0		334
RD 10-V2A	/ V2A	5680567	5021 23 9		311	TrayFix		5738428	5403 10 0		377
RD 10-V2A	/ V2A	5680567	5021 23 9		331						
RD 10-V4A	/ V4A	5902058	5021 64 2		311						
RD 10-V4A	/ V4A	5902058	5021 64 2		331						
RD 10-V4A	/ V4A	5680581	5021 64 7		311	TV 4+1		5022978	5083 40 0	/pc.	248
RD 10-V4A	/ V4A	5680581	5021 64 7		331						
RD 8-ALU	/ Al	5381914	5021 28 6		311	ÜSM-A		5080886	5092 45 1		212
RD 8-ALU	/ Al	5381914	5021 28 6		331	ÜSM-A-150		5475804	5092 46 6		212
RD 8-ALU-T	/ Al	5901273	5021 29 4		311	ÜSM-A-2		5247098	5092 46 0		212
RD 8-ALU-T	/ Al	5901273	5021 29 4		331	ÜSM-A-4		5613596	5092 47 2		212
RD 8-CU	/ Cu	5382034	5021 48 0		311	ÜSM-A-TW		5613589	5092 47 0		212
RD 8-CU	/ Cu	5382034	5021 48 0		331						
RD 8-FT	/ St / FT	5381556	5021 08 1		310	ÜSS 45-A-ALU	Aluminium painted	5006220	6117 46 7		213





Type	Dimensions/Colour/Div.	GTIN	Art. no.	Price	Page
				/pc.	
VF110-AC DC	150	5578154	5097 63 1		215
VF110-AC DC	150	5578154	5097 63 1		260
VF110-AC DC-FS	200150	5578192	5097 84 6		216
VF110-AC DC-FS	200150	5578192	5097 84 6		262
VF12-AC DC	13,5	5578116	5097 45 3		214
VF12-AC DC	13,5	5578116	5097 45 3		259
VF12-AC/DC-FS	1813,5	5736561	5097 45 4		261
VF2-110-AC/DCFS	150200	5578253	5097 93 5		217
VF2-110-AC/DCFS	150200	5578253	5097 93 5		263
VF2-230-AC/DC-FS	255350	5578260	5097 93 9		217
VF2-230-AC/DC-FS	255350	5578260	5097 93 9		263
VF2-24-AC/DC-FS	3446	5578246	5097 93 1		217
VF2-24-AC/DC-FS	3446	5578246	5097 93 1		263
VF230-AC/DC	255	5578161	5097 65 0		215
VF230-AC/DC	255	5578161	5097 65 0		260
VF230-AC-FS	255	5578215	5097 85 8		216
VF230-AC-FS	255	5578215	5097 85 8		262
VF24-AC/DC	34	5578123	5097 60 7		214
VF24-AC/DC	34	5578123	5097 60 7		259
VF24-AC/DC-FS	4634	5578185	5097 82 0		216
VF24-AC/DC-FS	4634	5578185	5097 82 0		261
VF48-AC/DC	60	5578130	5097 61 5		214
VF48-AC/DC	60	5578130	5097 61 5		259
VF48-AC/DC-FS	8060	5812258	5097 82 2		261
VF60-AC/DC	80	5578147	5097 62 3		214
VF60-AC/DC	80	5578147	5097 62 3		259
VF60-AC/DC-FS	11080	5812265	5097 82 4		262
VF-FS		5813521	5098 47 5		280
VG 3-B TNC		5531074	5089 21 2		139
VG 4-B TNS+TT		5531012	5089 20 0		138
VG LM	/ PA	5047155	5088 87 9		164
VG-BC DC-MSFS600	600	5835646	5088 69 5		227
VG-BC DC-MSFS900	900	5835653	5088 69 6		227
VG-BC DCPH900-21	900	5872641	5088 62 5		224
VG-BC DCPH900-31	900	5872658	5088 62 9		224
VG-BC DCPH-MS600	600	5613725	5088 69 3		226
VG-BC DCPH-MS900	900	5613718	5088 69 2		226
VG-BC DCPH-Y600	600	5709008	5088 67 6		229
VG-BC DCPH-Y900	900	5709015	5088 67 8		229
VG-C DCPH1000-21	1000	5829461	5088 64 6		224
VG-C DCPH1000-31	1000	5829478	5088 64 8		224
VG-C DC-PH1000-4	1000	5704010	5088 70 3		228
VG-C DCPH1000-4K	1000	5780700	5088 65 0		226
VG-C DCPH1000-4S	1000	5780717	5088 65 1		225
VG-C DCPH1000-6S	1000	5780724	5088 65 2		225
VG-C DC-PH-21	1000	5890805	5088 60 5		230
VG-C DC-PH-31	1000	5890812	5088 60 9		230
VG-C DC-PH-MS	1000	5371090	5088 69 4		230
VG-C DCPH-MS1000	1000	5613701	5088 69 1		226
VG-C DC-PH-Y	1000	5473206	5088 69 9		230
VG-C DCPH-Y1000	1000	5708964	5088 67 2		229
VG-C DCPH-Y600	600	5708957	5088 67 0		229
ZSF		5518419	2362 97 0		377

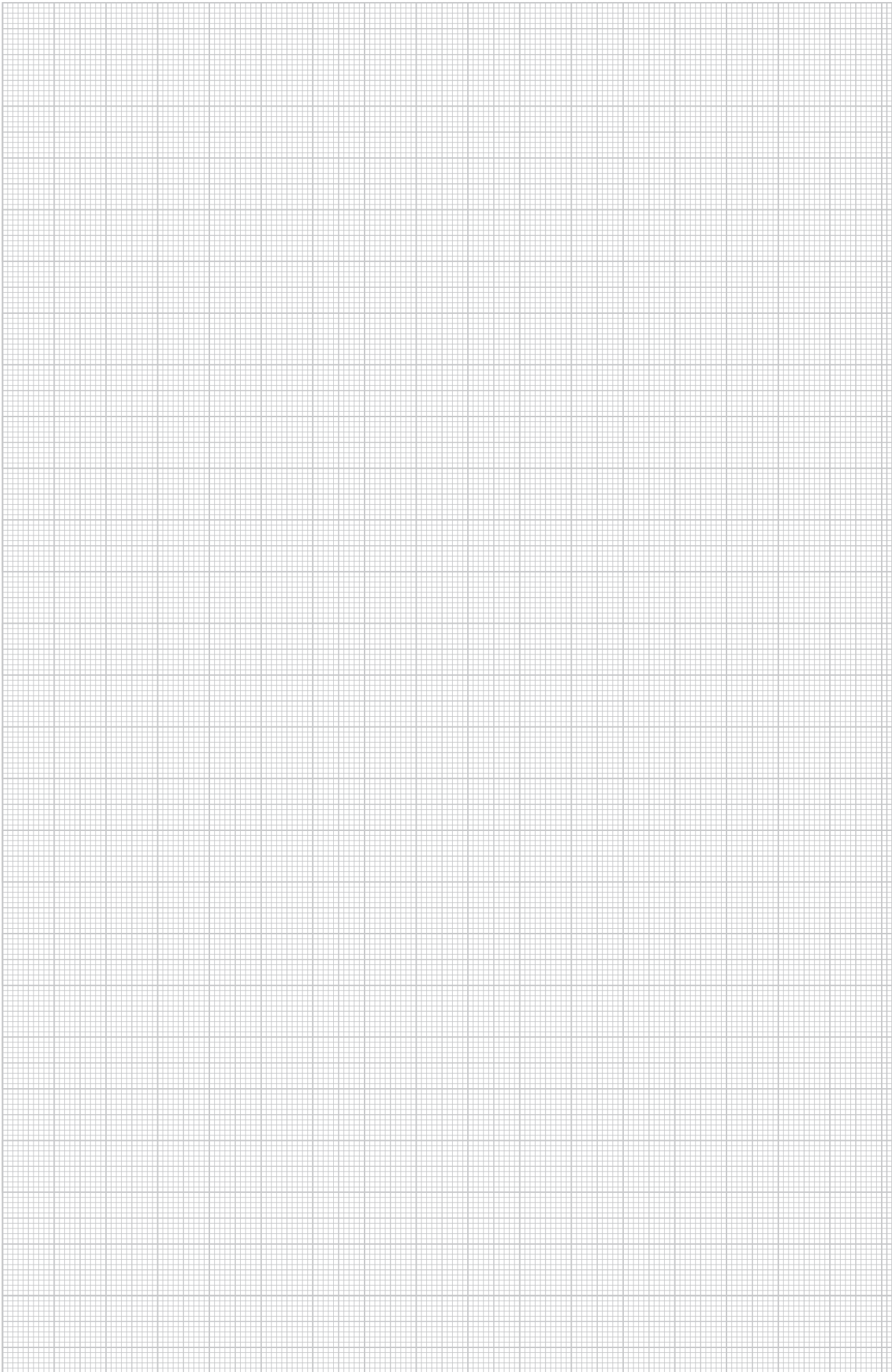



**Terms and conditions of sale and delivery**  
of OBO BETTERMANN GmbH & Co. KG, OBO BETTERMANN Projekt und Systemtechnik GmbH  
and OBO Befestigungselemente GmbH, Menden.

1. All our supplies and services shall be governed exclusively by the following terms and conditions, including our additional terms and conditions for cable tray business transactions. Any terms and conditions of business and purchasing of the customer shall be valid only if we have acknowledged them in writing. Our quotations are without engagement; they are mere invitations to submit contract offers. Any and all transactions and agreements, including those entered into by our employees and agents shall only be binding upon our written confirmation or invoicing. The foregoing provision shall also apply to any modifications of the agreed formal requirements.

2. The documents and data pertaining to the quotation, such as illustrations, brochures, drawings, dimensions, loading capacity values and weight details are approximate only, unless they are expressly stipulated to be binding.

Samples are non-binding samples for inspection. Any purchase according to sample will be subject to customary deviations and deviations resulting from normal production processes. The properties of the sample shall be no guaranteed quality of the purchase object unless expressly stated otherwise in the confirmation of order. Samples must be returned to us at the latest within four weeks in perfect condition. If they are not returned within this period in proper condition, we shall be entitled to charge the purchase price for the sample in accordance with our current price list. All information on our products, in particular the illustrations, drawings, weight, dimension and performance data included in our quotations and printed matter shall be regarded as approximate average values and shall not represent any quality guarantee.

With regard to products made according to customer drawings, samples and other instructions of the customer, we will not provide any warranty nor assume any liability for the due and proper functioning of the product or for any other defects if and to the extent they are based upon the customer's specifications. The customer shall indemnify us from any third party claims, including claims for product liability as may be asserted against us for damages resulting from the products unless we have caused such damages by intent or gross negligence. The customer shall warrant that the manufacture and supply of products made in accordance with his instructions will not infringe any proprietary rights of third parties. Should any proprietary rights be asserted against us, we shall be entitled, without any legal review of the third party claims, to withdraw from the contract after hearing the customer, unless the third party withdraws the claims asserted against us under its proprietary rights within eight days by written declaration. The customer shall compensate us for any damage sustained as a result of the assertion of proprietary rights. In case of withdrawal, the work we have carried out so far shall be remunerated. Further rights under the statutory provisions shall not be affected thereby.

Any moulds, tools and design data produced by us for the execution of the order shall be our exclusive property. Unless expressly agreed otherwise, the customer shall not have any claims thereto, even if he has contributed to the costs of producing any such moulds, tools and design data.

3. The packing, shipping route and means of transportation shall be left to our discretion in the absence of any other agreements. They shall be charged at their cost price. We will take back undamaged cases, when being returned carriage paid, at 2/3 of the amount invoiced. The one-way or pool pallets used for transport shall be either exchanged upon taking delivery or returned. The smallest packing units stocked and listed may not be broken up for rationalisation reasons. In case of orders for different quantities, the nearest packing unit will be supplied.

We reserve the right to deviate from the agreed delivery quantity, in particular in the case of custom-made products, to a customary extent or in conformity with national or international standards. In case of a demand for adhering to a precise quantity, an express reference is necessary and subject to confirmation.

Master and call orders shall oblige the customer to accept the total quantity on which the master/call order is based. Where no particular call orders are specified in the contract, the total quantity of the master call order must be called within twelve months. If the customer fails to adhere to call deadlines, we shall be entitled to deliver and charge the total quantity in full after four weeks from written notice with reference to the consequences of any failure to call. Our rights arising from any default of the customer shall not be affected thereby.

4. Unless otherwise agreed, our prices are quoted ex works and do not include packing and insurance. The value added tax at the rate applicable on the date of dispatch will be added to our prices. The purchaser shall ensure the correctness of his VAT identification number, which he must notify to us immediately without being asked. He shall undertake to inform both us and the competent domestic tax authority without delay of any change in his name, address and VAT identification number.

Delivery shall be franco domicile within Germany, i.e. carriage and packing prepaid, if the net order value is in excess of € 1,200. For small orders below € 100 (net excluding value added tax), we shall invoice a lower quantity surcharge of € 10 (net) per order. Upon transfer of our supplies and services to a carrier or forwarding agent, at the latest upon their leaving our warehouse or supply plant, the risk shall pass to the recipient, even in case of deliveries free place of destination.

5. Delivery periods and delivery deadlines shall be approximate only unless we have expressly stated in writing that they are binding. Delivery periods shall commence upon receipt of our confirmation of order, but not before clarification of all execution details, ex place of delivery. The customer shall only be entitled to withdraw from the contract after having granted a reasonable extension of time. We reserve the right to make partial deliveries. Claims for damages and reimbursement of expenses - for any reason whatsoever - shall be subject to the provisions set out in article 10.

In the event of any circumstances that are beyond our control within the scope of normal operating risks and obstruct or make impracticable any delivery, we shall be entitled to suspend delivery by the duration of such obstruction plus a reasonable start-up period or to withdraw from the contract for the part not yet fulfilled. The purchaser can demand a statement from us as to whether we wish to deliver within a reasonable period or withdraw. If we fail to make such a statement, the purchaser may withdraw. Our notice to the purchaser shall be deemed to be sufficient evidence that we have been prevented from delivering.

Delivery time is extended in case of such events as labour disputes, strikes and lockouts, orders from the authorities, difficulties with the procurement of materials, spoiled work or post-processing, shutdowns and staff shortage as well as shortage of means of transport, and general occurrence of unforeseen events beyond our scope of influence, by the length of duration of these events.

6. Payments shall be made upon receipt of invoice less a 3% cash discount for payment within 10 days or net after 30 days from date of invoice. Erection work and all paid labour work must be paid within 10 days without deduction of any cash discount. In case of non-cash payments, the date of the credit note will be deemed to be the date of receipt of payment. Payments received shall always be credited first against costs, then against interest and then against the earliest liability. Cheques and bills of exchange shall only be accepted as means of payment.

Any payment by bill of exchange shall be subject to a prior separate and written agreement, whereby all bill costs shall be borne by the customer and no discount can be granted. The customer shall have no right to refuse performance and no right of retention - for any legal reason whatsoever - unless we have acknowledged his claim beforehand in writing or his claim has the force of law.

The customer shall only be entitled to set off claims which have the force of law, are undisputed or acknowledged by us in writing.

7. We shall retain title to the goods supplied by us until all our claims arising from our business transactions with the customer have been satisfied - current account clause - and all bills of exchange or cheques submitted for payment by the customer have been honoured.

Any treatment or processing of goods subject to our retention of title (reserved goods) shall be carried out for us as the manufacturer in accordance with § 950 BGB (German Civil Code) without any obligation on our part. If our reserved goods are to be regarded as the main item or the main item is owned by the customer, full title to the new item shall pass to us when it is created. In other cases, we shall acquire a co-ownership interest in the new item in the proportion of the sales value of our reserved goods to the other goods used for the new item at the time of processing, intermingling, joining or mixing. The customer shall take custody of our ownership or co-ownership interest free of charge; it shall be treated as reserved goods.

Before transfer of title, our goods shall be neither pledged nor assigned as collateral without our prior consent. In addition, any third party rights or pledges shall be notified to us immediately and we shall be given all details and provided all documents necessary for intervention; otherwise the customer must bear our loss. In the latter case, our total claims against the customer shall also be immediately payable.

The customer shall be entitled to sell or to use our reserved goods in the ordinary course of business subject to the condition that the relevant claims are transferred in accordance with article 8 below. This right shall lapse upon the customer's failure to promptly meet his payment obligations towards us or in the event of any cheque or bill protests or his suspension of payments. In such cases, we shall be entitled to take back the goods provisionally at

the customer's expense and to sell them at our duly exercised discretion after a corresponding reminder has been sent to the customer. We will then pass the due amount to the customer's credit.

8. If our goods are sold before payment of our claim, the customer shall be obliged to retain our title against his purchaser until the goods have been paid for in full by the purchaser. The claim arising against the purchaser from such resale as well as any other ancillary rights or security interests of the customer resulting from the sale and any claims for compensation in case of damage to or destruction of our reserved property, including the relevant insurance sum shall hereby be assigned to us. We hereby accept this assignment. Where our co-ownership interest is sold, the relevant claims shall be assigned in the amount corresponding to the value of our interest.

The customer shall, at our request, inform us of his purchasers, notify them of the assignment made and provide us with any and all documents required to assert our rights.

As long as the customer meets his contractual obligations without delay, he shall be authorised to collect the claims assigned. He shall keep the amounts collected on our behalf separately and remit them to us immediately as soon and as far as our claims become due. The authorisation shall lapse in case of any cheque or bill protest of the customer or his definite suspension of payments. The customer shall bear the costs incurred for any action taken against third parties and shall advance them upon request.

If the security provided to us by the retention of title and the anticipatory assignment should exceed the claims to be secured by more than 20%, we shall, at the customer's request, release paid supplies of our choice. Upon payment of all our claims by the customer, assigned claims shall pass to the customer.

9. Any complaints for obvious defects regarding the quantity or quality of our supplies and services that are identifiable upon careful inspection shall without delay, but at the latest within the period of limitation of eight days from arrival of the goods at the address of the customer or the person appointed by him, be notified in writing to us, not to our representatives. Slight deviations in dimensions and designs within the scope of defined technical tolerances shall not give rise to any right of complaint. Any rejected goods may only be returned to us with our prior written authorisation.

In case of justified complaints within the prescribed period, we shall, at our option, take remedial action by way of subsequent performance, by rectifying the defect, supplying non-defective goods or providing a credit note for the lower value calculated.

We shall be entitled to refuse subsequent performance in accordance with the statutory provisions. If we refuse subsequent performance, if any subsequent performance remains unsuccessful or if the customer cannot be reasonably expected to accept any subsequent performance, the latter shall be entitled to withdraw from the contract in compliance with the provisions of the following sentences. The customer shall only be entitled to withdraw from the contract - where a withdrawal is not excluded by law - upon the unsuccessful expiry of a reasonable period for subsequent performance set by him, unless this period was not required under the statutory provisions (§§ 281 para. 2, 323 para. 2, 440, 441 para. 1 BGB (German Civil Code)).

In case of his withdrawal, the customer shall be liable for any deterioration, destruction or loss of use resulting from any negligence or intent on his part. Any claims for damages or reimbursement of expenses of the customer shall be subject to the provisions set out in article 10.

In the case of any fraudulent concealment of a defect or in the case of any provision of a quality guarantee for the goods sold at the time of the passing of risk within the meaning of § 444 BGB (German Civil Code) (seller's declaration that the object sold has a specific property at the time of the passing of risk and that the seller, regardless of any fault on his part, intends to be answerable for any and all consequences resulting from its absence), the customer's rights shall be exclusively governed by the statutory provisions.

We shall - in addition to the statutory grounds for refusal - also be entitled to refuse subsequent performance if and as long as the customer fails to send us, at our request, the rejected goods or a sample thereof; the customer shall have no right of withdrawal for any such refusal. We may further refuse any subsequent performance if the goods concerned have been altered or modified without our consent unless the customer can prove that the defect was not caused by such alteration or modification.

The limitation period for any claims arising from defects shall be one year; in the case of goods which have been used in accordance with their intended purpose for a building and have caused its defectiveness, the limitation period shall be two years. The provisions of §§ 478, 479 BGB (German Civil Code) on recourse in the chain of suppliers shall not be affected thereby.

10. In the case of a pre-contractual, contractual or non-contractual breach of duty, including unsatisfactory delivery, tortious conduct and producer's liability, we shall only be liable for compensatory damages and reimbursement of expenses - subject to further contractual or statutory liability requirements - in the case of intent, gross negligence or slightly negligent breach of a material contractual duty (contractual duty the infringement of which jeopardises the fulfilment of the object of the contract). However - except in the case of intent - our liability shall be limited to the typical contractual damage that was foreseeable at the time the contract was entered into.

The purchaser shall not be permitted to make a claim for expenses incurred in vain. Except for any breach of material duties, our liability for slight negligence shall be excluded, but in any case be limited to the amount of the purchase price.

Any claim asserted by the customer or a third party for payment of a contractual penalty shall be excluded.

With regard to damages caused by delay, we shall only be liable for slight negligence up to the amount of 5% of the purchase price agreed with us.

The exclusions and limitations of liability set forth above shall not apply in the event that a guarantee is given with respect to the quality of the object sold within the meaning of § 444 BGB (German Civil Code) if a defect is fraudulently concealed or in the event of injury to life, physical injury or injury to health, or strict liability under the German Product Liability Act.

Any and all claims for damages against us, for any legal reason whatsoever, shall become statute-barred at the latest after one year from delivery of the goods to the customer, in the case of tortious liability from the time of knowledge, or grossly negligent ignorance, of the circumstances giving rise to the claim and the person liable to pay damages. This provision shall not apply in the case of liability for intent and in the event that a guarantee is given for the quality of the object sold, in the case of fraudulent concealment of a defect or in the event of injury to life, physical injury or injury to health, or strict liability under the German Product Liability Act. Any shorter limitation periods shall take precedence.

11. We shall be entitled to process and store any customer data obtained with regard to or in connection with the business relationship in accordance with the German Federal Data Protection Act, irrespective of whether such data is provided by the purchaser himself or by any third parties.

12. Place of performance for delivery and payment is Menden/Sauerland. The court of competent jurisdiction for any and all disputes, including disputes with regard to bills of exchange and cheques, is the Local Court (Amtsgericht) of Menden or, at our option, the District Court (Landgericht) of Arnsberg, irrespective of the value of the object in dispute. We shall, however, also be entitled to take legal proceedings against the customer at the place of his registered office.

German law shall be exclusively applicable. The application of international purchase laws is hereby excluded.

Should, for any reason whatsoever, individual provisions of our terms and conditions of sale and delivery be invalid, the validity and binding nature of the other provisions shall not be affected thereby. The customer agrees, that the invalid provision shall be replaced by a valid provision that comes as close as possible to the economic meaning of the invalid provision.

13. The prices of products made of brass and copper are subject to certain fluctuations that are based on the relevant DEL listings. The prices of our brass articles are based on a DEL listing of € 150 for Ms 58, those of our copper products on a DEL value for electrolyte copper of € 200.

In case of any increase or reduction in these prices by more than € 15, a five per cent surcharge or deduction shall be made for each 15 points. The calculation of any such surcharges or deductions shall be based on the DEL listing of the date of our receipt of the order.

Valid from January 2010



**Terms and conditions of sale and delivery**  
of OBO BETTERMANN GmbH & Co. KG, OBO BETTERMANN Projekt und Systemtechnik GmbH  
and OBO Befestigungselemente GmbH, Menden.

1. All our supplies and services shall be governed exclusively by the following terms and conditions, including our additional terms and conditions for cable tray business transactions. Any terms and conditions of business and purchasing of the customer shall be valid only if we have acknowledged them in writing. Our quotations are without engagement; they are mere invitations to submit contract offers. Any and all transactions and agreements, including those entered into by our employees and agents shall only be binding upon our written confirmation or invoicing. The foregoing provision shall also apply to any modifications of the agreed formal requirements.

2. The documents and data pertaining to the quotation, such as illustrations, brochures, drawings, dimensions, loading capacity values and weight details are approximate only, unless they are expressly stipulated to be binding.

Samples are non-binding samples for inspection. Any purchase according to sample will be subject to customary deviations and deviations resulting from normal production processes. The properties of the sample shall be no guaranteed quality of the purchase object unless expressly stated otherwise in the confirmation of order. Samples must be returned to us at the latest within four weeks in perfect condition. If they are not returned within this period in proper condition, we shall be entitled to charge the purchase price for the sample in accordance with our current price list. All information on our products, in particular the illustrations, drawings, weight, dimension and performance data included in our quotations and printed matter shall be regarded as approximate average values and shall not represent any quality guarantee.

With regard to products made according to customer drawings, samples and other instructions of the customer, we will not provide any warranty nor assume any liability for the due and proper functioning of the product or for any other defects if and to the extent they are based upon the customer's specifications. The customer shall indemnify us from any third party claims, including claims for product liability as may be asserted against us for damages resulting from the products unless we have caused such damages by intent or gross negligence. The customer shall warrant that the manufacture and supply of products made in accordance with his instructions will not infringe any proprietary rights of third parties. Should any proprietary rights be asserted against us, we shall be entitled, without any legal review of the third party claims, to withdraw from the contract after hearing the customer, unless the third party withdraws the claims asserted against us under its proprietary rights within eight days by written declaration. The customer shall compensate us for any damage sustained as a result of the assertion of proprietary rights. In case of withdrawal, the work we have carried out so far shall be remunerated. Further rights under the statutory provisions shall not be affected thereby.

Any moulds, tools and design data produced by us for the execution of the order shall be our exclusive property. Unless expressly agreed otherwise, the customer shall not have any claims thereto, even if he has contributed to the costs of producing any such moulds, tools and design data.

3. The packing, shipping route and means of transportation shall be left to our discretion in the absence of any other agreements. They shall be charged at their cost price. We will take back undamaged cases, when being returned carriage paid, at 2/3 of the amount invoiced. The one-way or pool pallets used for transport shall be either exchanged upon taking delivery or returned. The smallest packing units stocked and listed may not be broken up for rationalisation reasons. In case of orders for different quantities, the nearest packing unit will be supplied.

We reserve the right to deviate from the agreed delivery quantity, in particular in the case of custom-made products, to a customary extent or in conformity with national or international standards. In case of a demand for adhering to a precise quantity, an express reference is necessary and subject to confirmation.

Master and call orders shall oblige the customer to accept the total quantity on which the master/call order is based. Where no particular call orders are specified in the contract, the total quantity of the master call order must be called within twelve months. If the customer fails to adhere to call deadlines, we shall be entitled to deliver and charge the total quantity in full after four weeks from written notice with reference to the consequences of any failure to call. Our rights arising from any default of the customer shall not be affected thereby.

4. Unless otherwise agreed, our prices are quoted ex works and do not include packing and insurance. The value added tax at the rate applicable on the date of dispatch will be added to our prices. The purchaser shall ensure the correctness of his VAT identification number, which he must notify to us immediately without being asked. He shall undertake to inform both us and the competent domestic tax authority without delay of any change in his name, address and VAT identification number.

Delivery shall be franco domicile within Germany, i.e. carriage and packing prepaid, if the net order value is in excess of € 1,200. For small orders below € 100 (net excluding value added tax), we shall invoice a lower quantity surcharge of € 10 (net) per order. Upon transfer of our supplies and services to a carrier or forwarding agent, at the latest upon their leaving our warehouse or supply plant, the risk shall pass to the recipient, even in case of deliveries free place of destination.

5. Delivery periods and delivery deadlines shall be approximate only unless we have expressly stated in writing that they are binding. Delivery periods shall commence upon receipt of our confirmation of order, but not before clarification of all execution details, ex place of delivery. The customer shall only be entitled to withdraw from the contract after having granted a reasonable extension of time. We reserve the right to make partial deliveries. Claims for damages and reimbursement of expenses - for any reason whatsoever - shall be subject to the provisions set out in article 10.

In the event of any circumstances that are beyond our control within the scope of normal operating risks and obstruct or make impracticable any delivery, we shall be entitled to suspend delivery by the duration of such obstruction plus a reasonable start-up period or to withdraw from the contract for the part not yet fulfilled. The purchaser can demand a statement from us as to whether we wish to deliver within a reasonable period or withdraw. If we fail to make such a statement, the purchaser may withdraw. Our notice to the purchaser shall be deemed to be sufficient evidence that we have been prevented from delivering.

Delivery time is extended in case of such events as labour disputes, strikes and lockouts, orders from the authorities, difficulties with the procurement of materials, spoiled work or post-processing, shutdowns and staff shortage as well as shortage of means of transport, and general occurrence of unforeseen events beyond our scope of influence, by the length of duration of these events.

6. Payments shall be made upon receipt of invoice less a 3% cash discount for payment within 10 days or net after 30 days from date of invoice. Erection work and all paid labour work must be paid within 10 days without deduction of any cash discount. In case of non-cash payments, the date of the credit note will be deemed to be the date of receipt of payment. Payments received shall always be credited first against costs, then against interest and then against the earliest liability. Cheques and bills of exchange shall only be accepted as means of payment.

Any payment by bill of exchange shall be subject to a prior separate and written agreement, whereby all bill costs shall be borne by the customer and no discount can be granted. The customer shall have no right to refuse performance and no right of retention - for any legal reason whatsoever - unless we have acknowledged his claim beforehand in writing or his claim has the force of law.

The customer shall only be entitled to set off claims which have the force of law, are undisputed or acknowledged by us in writing.

7. We shall retain title to the goods supplied by us until all our claims arising from our business transactions with the customer have been satisfied - current account clause - and all bills of exchange or cheques submitted for payment by the customer have been honoured.

Any treatment or processing of goods subject to our retention of title (reserved goods) shall be carried out for us as the manufacturer in accordance with § 950 BGB (German Civil Code) without any obligation on our part. If our reserved goods are to be regarded as the main item or the main item is owned by the customer, full title to the new item shall pass to us when it is created. In other cases, we shall acquire a co-ownership interest in the new item in the proportion of the sales value of our reserved goods to the other goods used for the new item at the time of processing, intermingling, joining or mixing. The customer shall take custody of our ownership or co-ownership interest free of charge; it shall be treated as reserved goods.

Before transfer of title, our goods shall be neither pledged nor assigned as collateral without our prior consent. In addition, any third party rights or pledges shall be notified to us immediately and we shall be given all details and provided all documents necessary for intervention; otherwise the customer must bear our loss. In the latter case, our total claims against the customer shall also be immediately payable.

The customer shall be entitled to sell or to use our reserved goods in the ordinary course of business subject to the condition that the relevant claims are transferred in accordance with article 8 below. This right shall lapse upon the customer's failure to promptly meet his payment obligations towards us or in the event of any cheque or bill protests or his suspension of payments. In such cases, we shall be entitled to take back the goods provisionally at

the customer's expense and to sell them at our duly exercised discretion after a corresponding reminder has been sent to the customer. We will then pass the due amount to the customer's credit.

8. If our goods are sold before payment of our claim, the customer shall be obliged to retain our title against his purchaser until the goods have been paid for in full by the purchaser. The claim arising against the purchaser from such resale as well as any other ancillary rights or security interests of the customer resulting from the sale and any claims for compensation in case of damage to or destruction of our reserved property, including the relevant insurance sum shall hereby be assigned to us. We hereby accept this assignment. Where our co-ownership interest is sold, the relevant claims shall be assigned in the amount corresponding to the value of our interest.

The customer shall, at our request, inform us of his purchasers, notify them of the assignment made and provide us with any and all documents required to assert our rights.

As long as the customer meets his contractual obligations without delay, he shall be authorised to collect the claims assigned. He shall keep the amounts collected on our behalf separately and remit them to us immediately as soon and as far as our claims become due. The authorisation shall lapse in case of any cheque or bill protest of the customer or his definite suspension of payments. The customer shall bear the costs incurred for any action taken against third parties and shall advance them upon request.

If the security provided to us by the retention of title and the anticipatory assignment should exceed the claims to be secured by more than 20%, we shall, at the customer's request, release paid supplies of our choice. Upon payment of all our claims by the customer, assigned claims shall pass to the customer.

9. Any complaints for obvious defects regarding the quantity or quality of our supplies and services that are identifiable upon careful inspection shall without delay, but at the latest within the period of limitation of eight days from arrival of the goods at the address of the customer or the person appointed by him, be notified in writing to us, not to our representatives. Slight deviations in dimensions and designs within the scope of defined technical tolerances shall not give rise to any right of complaint. Any rejected goods may only be returned to us with our prior written authorisation.

In case of justified complaints within the prescribed period, we shall, at our option, take remedial action by way of subsequent performance, by rectifying the defect, supplying non-defective goods or providing a credit note for the lower value calculated.

We shall be entitled to refuse subsequent performance in accordance with the statutory provisions. If we refuse subsequent performance, if any subsequent performance remains unsuccessful or if the customer cannot be reasonably expected to accept any subsequent performance, the latter shall be entitled to withdraw from the contract in compliance with the provisions of the following sentences. The customer shall only be entitled to withdraw from the contract - where a withdrawal is not excluded by law - upon the unsuccessful expiry of a reasonable period for subsequent performance set by him, unless this period was not required under the statutory provisions (§§ 281 para. 2, 323 para. 2, 440, 441 para. 1 BGB (German Civil Code)).

In case of his withdrawal, the customer shall be liable for any deterioration, destruction or loss of use resulting from any negligence or intent on his part. Any claims for damages or reimbursement of expenses of the customer shall be subject to the provisions set out in article 10.

In the case of any fraudulent concealment of a defect or in the case of any provision of a quality guarantee for the goods sold at the time of the passing of risk within the meaning of § 444 BGB (German Civil Code) (seller's declaration that the object sold has a specific property at the time of the passing of risk and that the seller, regardless of any fault on his part, intends to be answerable for any and all consequences resulting from its absence), the customer's rights shall be exclusively governed by the statutory provisions.

We shall - in addition to the statutory grounds for refusal - also be entitled to refuse subsequent performance if and as long as the customer fails to send us, at our request, the rejected goods or a sample thereof; the customer shall have no right of withdrawal for any such refusal. We may further refuse any subsequent performance if the goods concerned have been altered or modified without our consent unless the customer can prove that the defect was not caused by such alteration or modification.

The limitation period for any claims arising from defects shall be one year; in the case of goods which have been used in accordance with their intended purpose for a building and have caused its defectiveness, the limitation period shall be two years. The provisions of §§ 478, 479 BGB (German Civil Code) on recourse in the chain of suppliers shall not be affected thereby.

10. In the case of a pre-contractual, contractual or non-contractual breach of duty, including unsatisfactory delivery, tortious conduct and producer's liability, we shall only be liable for compensatory damages and reimbursement of expenses - subject to further contractual or statutory liability requirements - in the case of intent, gross negligence or slightly negligent breach of a material contractual duty (contractual duty the infringement of which jeopardises the fulfilment of the object of the contract). However - except in the case of intent - our liability shall be limited to the typical contractual damage that was foreseeable at the time the contract was entered into.

The purchaser shall not be permitted to make a claim for expenses incurred in vain. Except for any breach of material duties, our liability for slight negligence shall be excluded, but in any case be limited to the amount of the purchase price.

Any claim asserted by the customer or a third party for payment of a contractual penalty shall be excluded.

With regard to damages caused by delay, we shall only be liable for slight negligence up to the amount of 5% of the purchase price agreed with us.

The exclusions and limitations of liability set forth above shall not apply in the event that a guarantee is given with respect to the quality of the object sold within the meaning of § 444 BGB (German Civil Code) if a defect is fraudulently concealed or in the event of injury to life, physical injury or injury to health, or strict liability under the German Product Liability Act.

Any and all claims for damages against us, for any legal reason whatsoever, shall become statute-barred at the latest after one year from delivery of the goods to the customer, in the case of tortious liability from the time of knowledge, or grossly negligent ignorance, of the circumstances giving rise to the claim and the person liable to pay damages. This provision shall not apply in the case of liability for intent and in the event that a guarantee is given for the quality of the object sold, in the case of fraudulent concealment of a defect or in the event of injury to life, physical injury or injury to health, or strict liability under the German Product Liability Act. Any shorter limitation periods shall take precedence.

11. We shall be entitled to process and store any customer data obtained with regard to or in connection with the business relationship in accordance with the German Federal Data Protection Act, irrespective of whether such data is provided by the purchaser himself or by any third parties.

12. Place of performance for delivery and payment is Menden/Sauerland. The court of competent jurisdiction for any and all disputes, including disputes with regard to bills of exchange and cheques, is the Local Court (Amtsgericht) of Menden or, at our option, the District Court (Landgericht) of Arnsberg, irrespective of the value of the object in dispute. We shall, however, also be entitled to take legal proceedings against the customer at the place of his registered office.

German law shall be exclusively applicable. The application of international purchase laws is hereby excluded.

Should, for any reason whatsoever, individual provisions of our terms and conditions of sale and delivery be invalid, the validity and binding nature of the other provisions shall not be affected thereby. The customer agrees, that the invalid provision shall be replaced by a valid provision that comes as close as possible to the economic meaning of the invalid provision.

13. The prices of products made of brass and copper are subject to certain fluctuations that are based on the relevant DEL listings. The prices of our brass articles are based on a DEL listing of € 150 for Ms 58, those of our copper products on a DEL value for electrolyte copper of € 200.

In case of any increase or reduction in these prices by more than € 15, a five per cent surcharge or deduction shall be made for each 15 points. The calculation of any such surcharges or deductions shall be based on the DEL listing of the date of our receipt of the order.

Valid from January 2010





#### **QR-Code**

With the QR Code you have direct access to our products on the Internet.

You can find further information on the QR Code at [www.obo-bettermann.com](http://www.obo-bettermann.com).

#### **OBO BETTERMANN GmbH & Co. KG**

P.O. Box 1120  
58694 Menden, Germany

#### **Customer Service Germany**

Tel. +49 (0)2373 89-1500  
Fax +49 (0)2373 89-7777  
E-mail: [info@obo.de](mailto:info@obo.de)

[www.obo-bettermann.com](http://www.obo-bettermann.com)