

TBS | Catalogue 2012/2013



# Transient and lightning protection systems

THINK CONNECTED.

## Welcome to Customer Service

---

**Service telephone: +49 (0)2373 89-1500**

---

**Telefax for enquiries: +49 (0)2373 89-7777**

---

**Fax for orders: +49 (0)2373 89-7755**

---

**E-mail: [info@obo.de](mailto:info@obo.de)**

**Internet: [www.obo-bettermann.com](http://www.obo-bettermann.com)**



Use the direct line to OBO Customer Service! We are available on our Service Hotline on +49 (0)2373 89-1500 from 7.30 a.m. to 5.00 p.m. for any questions to do with the OBO complete product range for electrical installations. The newly structured OBO Customer Service can offer you the full service:

- Competent contacts from your region
- All the information on the OBO product range
- Knowledgeable advice on special application topics
- Quick, direct access to all the technical data of the OBO products – we also want to provide the best in customer relations!

# Contents

	Planning aids	5
	Surge protection energy technology, arrester, Type 1	135
	Surge protection energy technology, arrester, Type 1+2	145
	Surge protection energy technology, arrester, Type 2	173
	Surge protection energy technology, arrester, Type 2+3	199
	Surge protection energy technology, arrester, Type 3	209
	Sure protection, photovoltaics	219
	Data and information technology	235
	Protection and spark gaps	287
	Measuring and test systems	291
	Equipotential bonding systems	295
	Earthing systems	309
	Interception and arrester systems	329
	Insulated lightning protection and OBO isCon® system	381
	Directories	397





#### **OBO TBS seminars: First-hand knowledge**

With a comprehensive programme of training courses and seminars on the subject of surge voltage and lightning protection systems, OBO is able to support its customers with specialist knowledge from a single source. Alongside the basic theoretical principles, the programme also deals with practical implementation in everyday applications. Special calculation and application examples round off the comprehensive programme of knowledge transfer.

#### **Invitations to tender, product information and datasheets**

We can make life easier for you: With our comprehensive selection of materials designed for practical applications, which provide you with effective support with the planning and calculation of a project. These include:

- Invitations to tender
- Product information
- Information sheets
- Datasheets









These documents are continually updated and can be downloaded at no charge at any time from the Internet download area at [www.obo.de](http://www.obo.de).

#### **Invitations to tender on the Internet at [www.ausschreiben.de](http://www.ausschreiben.de)**

More than 10,000 entries from the KTS, BSS, TBS, LFS, EGS and UFS ranges can be called up free of charge. Regular updates and expansions mean that you always have a comprehensive overview of the OBO products. All the current file formats – PDF, DOC, GAEB, HTML, TEXT, XML, ÖNORM – are available.

[www.ausschreiben.de](http://www.ausschreiben.de)

## Contents of planning and mounting aids

	Basic principles of surge voltage protection	6
	Surge protection energy technology	19
	Sure protection, photovoltaics	27
	Surge protection device for data and information technology	43
	Protection and spark gaps	65
	Measuring and test systems	69
	Equipotential bonding systems	73
	Earthing systems	77
	Interception and arrester systems	87
	Insulated lightning protection and OBO isCon® system	113
	Additional information	126



## Minor cause, major effect: Damage caused by surge voltages



Our dependency on electrical and electronic equipment continues to increase, in both our professional or private lives. Data networks in companies or emergency facilities such as hospitals and fire stations are lifelines for an essential real time information exchange. Sensitive databases, e.g. in banks or media publishers, need reliable transmission paths.

It is not only lightning strikes that pose a latent threat to these systems. More and more frequently, today's electronic aids are damaged by surge voltages caused by remote lightning discharges or switching operations in large electrical systems. During thunderstorms too, high volumes of energy are instantaneously released. These voltage peaks can penetrate a building through all manner of conductive connections and cause enormous damage.





### What are the consequences of damage caused by surge voltages in our daily lives?

The most obvious one is the destruction of electrical equipment. In private households, these are specifically:

- TV/DVD players
- Telephone systems
- Computer systems, stereo systems
- Kitchen appliances
- Monitoring systems
- Fire alarm systems

The failure of such equipment certainly incurs great expense. What happens when the following suffer outage times / consequential damage:

- Computers (loss of data)
- Heating/water heating systems
- Lift, garage door and roller shutter drives
- Triggering or destruction of fire / burglar alarm systems (costs through a false alarm)?

A vital topic perhaps, particularly in office buildings, because:

- Can work continue in your company without a central computer / server?
- Was all the important data backed up in time?

### Growing sums of damage

Current statistics and estimates of insurance companies show: Damage levels caused by surges – excluding consequential or outage costs – long since reached drastic levels due to the growing dependency on electronic "aids". It's no surprise, then, that property insurers are checking more and more claims and stipulating the use of devices to protect against surges. Information on protection measures is contained, e.g. in Directive VDS 2010.





## Creation of lightning discharges



Creation of lightning discharges: 1 = approx. 6,000 m, approx.  $-30\text{ }^{\circ}\text{C}$ , 2 = approx. 15,000 m, approx.  $-70\text{ }^{\circ}\text{C}$

### Discharge types

Some 90% of all lightning discharges between a cloud and the ground are negative cloud-earth strikes. The lightning begins in a negatively charged area of the cloud and spreads to the positively charged surface of the earth. Additional discharges are divided into:

- Negative earth-cloud strikes
- Positive cloud-earth strikes
- Positive earth-cloud strikes.

The most common discharges actually occur within a cloud or between different clouds.

### Creation of lightning discharges

When warm, damp air masses rise, the air humidity condenses and ice crystals are formed at great heights. Storm fronts can occur when the clouds expand to heights of up to 15,000 m. The strong upwind of up to 100 kilometres per hour causes the light ice crystals to enter the higher area and the sleet particles enter the lower area. Knocks and friction cause electrical discharge.





### Negative and positive charges

Studies have proved that the sleet falling down (area warmer than  $-15\text{ }^{\circ}\text{C}$ ) has a negative charge and the ice crystals being thrown upwards (area colder than  $-15\text{ }^{\circ}\text{C}$ ) has a positive charge. The light ice crystals are carried into the upper areas of the cloud by the upwind and the sleet falls to the central areas of the cloud. This divided the clouds into the three areas:

- Top: Positively charged zone
- Centre: Weakly negative charged zone
- Bottom: Weakly positive charged zone

This separation of charges forms a voltage in the cloud.



Negative and positive charges: 1 = Sleet, 2 = Ice crystals

### Load distribution

Typical load distribution:

- Positive at the top, negative in the centre and weakly positive at the bottom.
- Positive charges can also be found in the area near the ground.
- The field strength required to trigger lightning is dependent on the insulating ability of the air and is between 0.5 and 10 kV/cm.



Charge distribution: 1 = approx. 6,000 m, 2 = Electrical field



## What are transient surges?

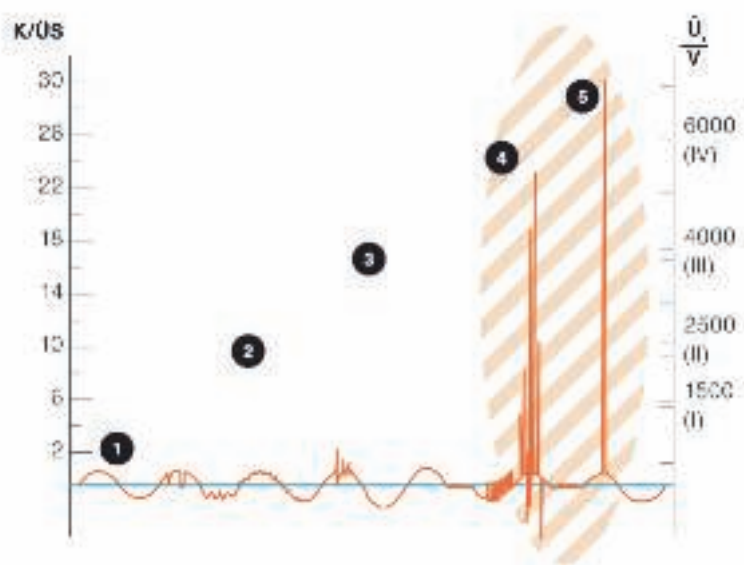

Transient surge voltages: 1 = Voltage drops/brief interruptions, 2 = Harmonic waves through slow and rapid voltage changes, 3 = Temporary voltage increases, 4 = Switching surges, 5 = Lightning surge voltages, hatched = application for surge protection devices

**Transient surge voltages are brief voltage peaks lasting microseconds, which may be a multiple of the attached mains nominal voltage.**

### Direct strike

The largest voltage peaks in the low-voltage consumer network are caused by lightning discharges. The high energy content of lightning surges when a direct strike hits the external lightning protection system or a low-voltage open-wire line usually causes – without internal lightning and surge protection – total outage of the connected consumers and damage to the insulation.

### Induced voltage peaks and switching surge voltages

Yet induced voltage peaks in building installations and energy or data line supply cables can also reach many times the nominal operating voltage. Switching surges too, which in fact do not cause such high voltage peaks as lightning discharges but occur much more frequently, can result in immediate system failure. As a rule, switching surges amount to twice to three times the operating voltage, lightning surges on the other hand can sometimes reach 20 times the nominal voltage value and transport a high energy content.

### Delayed failures

Often, failures occur only after a time delay as the aging process of electronic components in the affected devices triggered by smaller transients causes insidious damage. A number of different protection measures are required. These depend on the exact cause and/or impact point of the lightning discharge.



## What pulse forms are there?

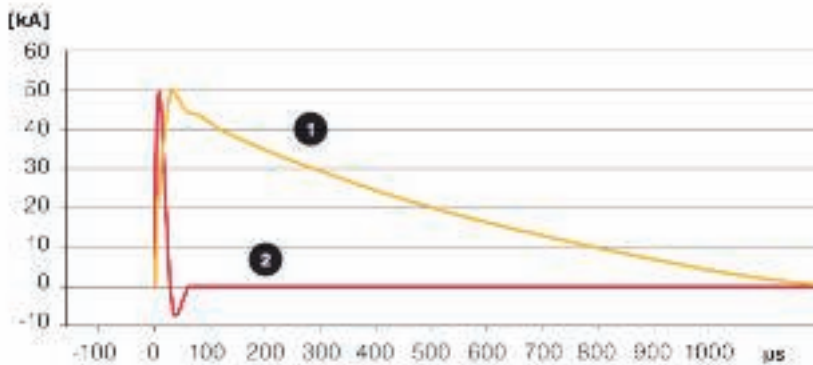

Pulse types and their characteristics: Yellow = pulse shape 1, direct lightning strike, 10/350  $\mu\text{s}$  simulated lightning pulse, red = pulse shape 2, remote lightning strike or switching operation, 8/20  $\mu\text{s}$  simulated lightning pulse (Surge)

### Testing currents simulate potential increase

High lightning currents can flow to the ground during a storm. If a building with external lightning protection receives a direct hit, a voltage drop occurs on the earthing resistor of the lightning protection equipotential bonding system, which represents a surge voltage against the distant environment. This rise in potential poses a threat to the electrical systems (e.g. voltage supply, telephone systems, cable TV, control cables, etc.) that are routed into the building. Suitable test currents for testing different lightning and surge protectors have been defined in national and international standards.

### Direct lightning strike: Pulse shape 1

Lightning currents that can occur during a direct lightning strike can be imitated with the surge current of wave form 10/350  $\mu\text{s}$ . The lightning test current imitates both the fast rise and the high energy content of natural lightning. Lightning current arrester type 1 and external lightning protection components are tested using this current.

### Remote lightning strikes or switching operations: Pulse shape 2

The surges created by remote lightning strikes and switching operations are imitated with test impulse 8/20  $\mu\text{s}$ . The energy content of this impulse is significantly lower than the lightning test current of surge current wave 10/350  $\mu\text{s}$ . Surge arrester type 2 and type 3 are impacted with this test impulse.



## Causes of lightning currents

### Direct lightning strike into a building

If a lightning strike hits the external lightning protection system or earthed roof structures capable of carrying lightning current (e.g. roof aerial), then the lightning energy can be arrested to the ground in advance. However, a lightning protection system on its own is not enough: Due to its impedance, the building's entire earthing system is raised to a high potential. This potential increase causes the lightning current to spill over the building's earthing system and also over the power supply systems and data cables to the adjacent earthing systems (adjacent building, low-voltage transformer).

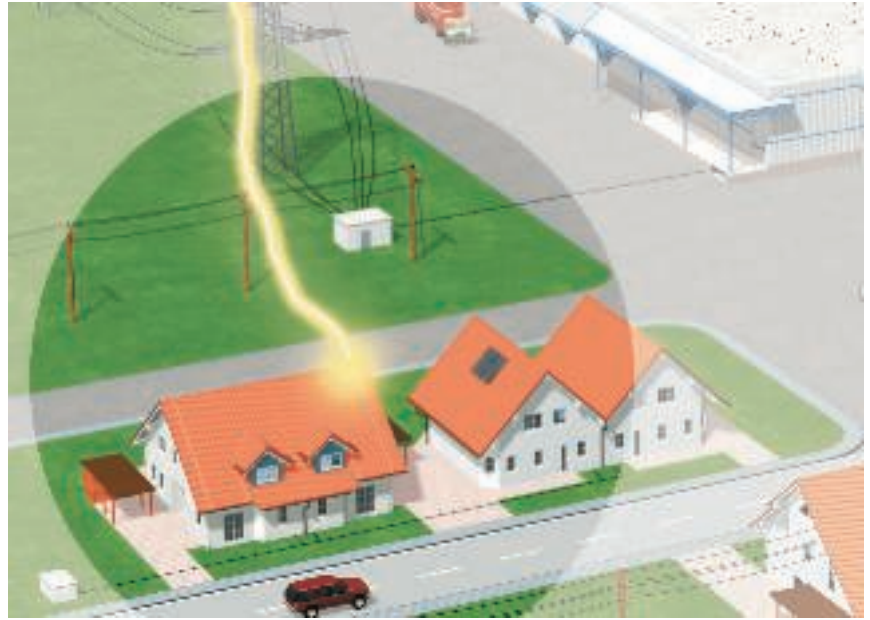

#### Risk:

Lightning impulse (10/350)

### Direct lightning strike into a low-voltage open-wire line

A direct lightning strike into a low-voltage open wire line or data cable can couple high partial lightning currents in an adjacent building. Electrical equipment in buildings at the end of the low-voltage open-wire line are at particular risk of damage caused by surges.

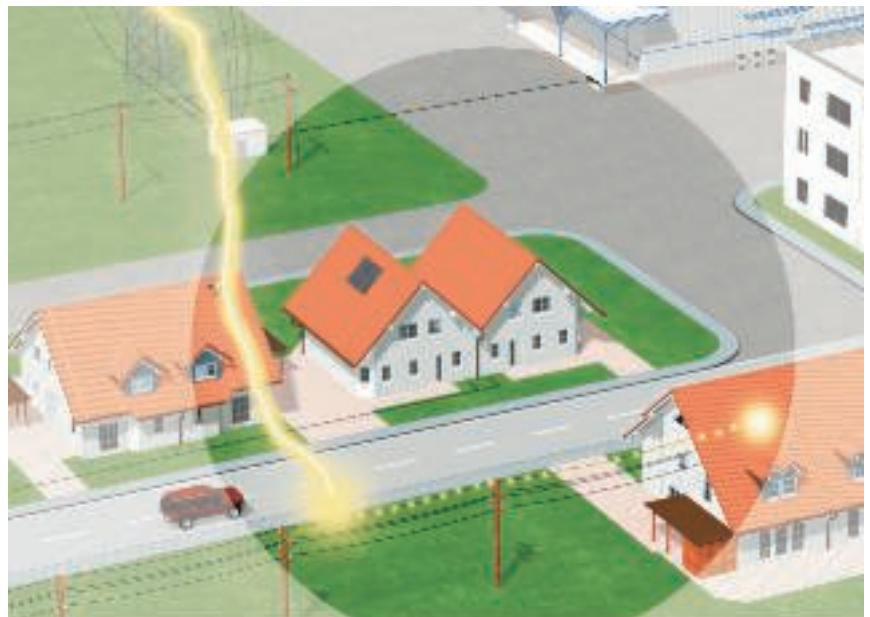

#### Risk:

Lightning impulse (10/350)



## Causes of surges

### Switching surges in the low-voltage system

Switching surges are caused by switch-on and switch-off operations, by switching inductive and capacitive loads and by interrupting short-circuit currents. Particularly when production plants, lighting systems or transformers are switched off, electrical equipment located in close proximity can be damaged.

---

**Risk:**  
Surge impulse (8/20)

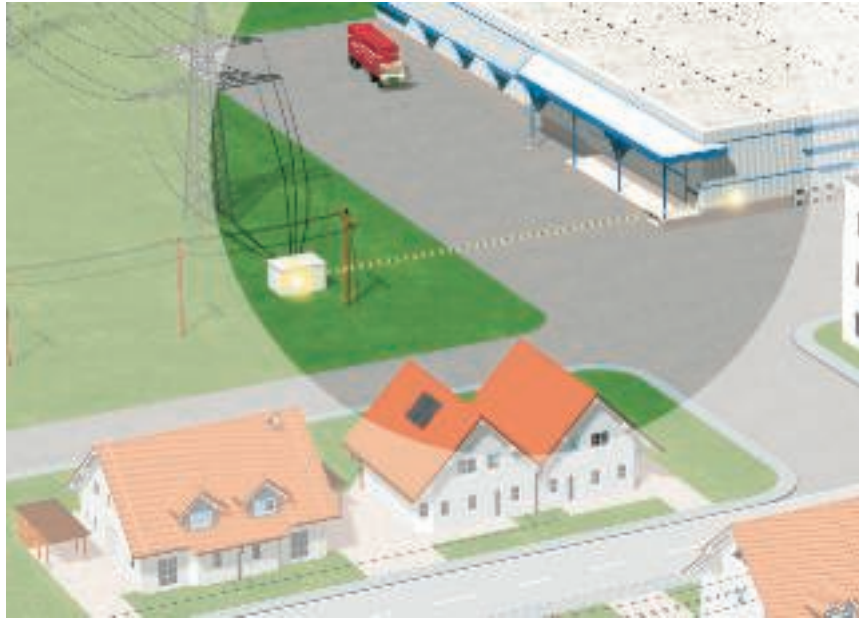

### Coupling of surges through local or remote lightning strike

Even if lightning protection and surge protection measures are already installed: A local lightning strike creates additional high magnetic fields, which in turn induce high voltage peaks in line systems. Inductive or galvanic coupling can cause damage within a radius of up to 2 km around the lightning impact point.

---

**Risk:**  
Surge impulse (8/20)

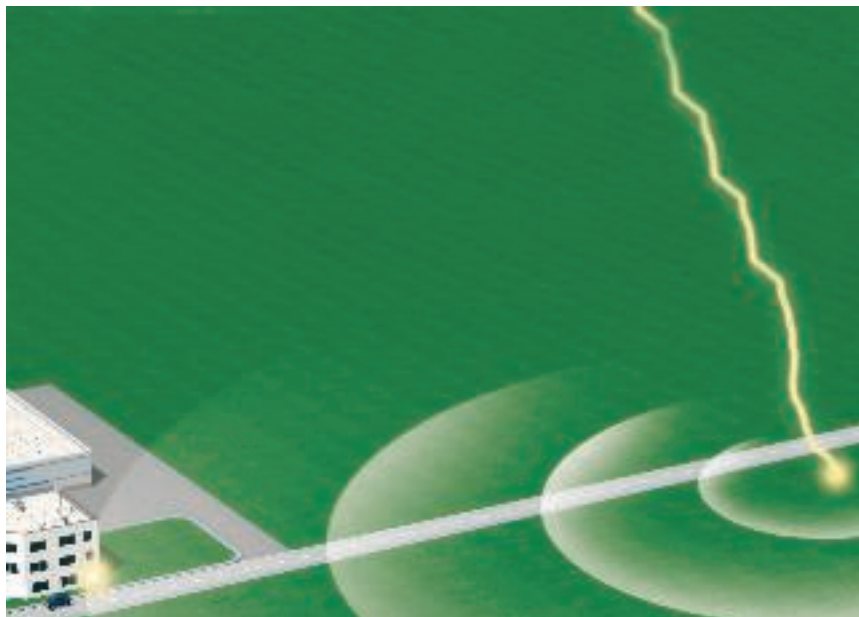



## Gradual surge reduction with lightning protection zones



### Lightning protection zone concept

The lightning protection zone concept described in international standard IEC 62305-4 (DIN VDE 0185 Part 4) has proved to be practical and efficient. This concept

is based on the principle of gradually reducing surges to a safe level before they reach the terminal device and cause damage. In order to achieve this situation, a building's entire energy network is split into lightning protection zones (LPZ = Lightning Protec-

tion Zone). Installed at each transition from one zone to another is a surge arrester for equipotential bonding. These arrestors correspond to the requirement class in question.

### Lightning protection zone

LPZ 0 A	Unprotected zone outside the building. Direct lightning strike, no shielding against electromagnetic interference pulses LEMP (Lightning Electromagnetic Pulse)
LPZ 0 B	Through the area protected by the external lightning protection system. No shielding against LEMP.
LPZ 1	Zone inside the building. Low partial lightning energies possible.
LPZ 2	Zone inside the building. Low surges possible.
LPZ 3	Zone inside the building (can also be the metal housing of a consumer). No interference pulses through LEMP or surges present.



## Zone transitions and protective devices

### Benefits of the lightning protection zone concept

- Minimisation of the couplings into other cable systems through arresting the energy-rich, dangerous lightning currents directly at the point the cables enter the building.
- Malfunction prevention with magnetic fields.
- Economic, well-plannable individual protection concept for new and old buildings and reconstructions.



### Type classes of the surge protection devices

OBO surge protection devices are classified in accordance with DIN EN 61643-11 into three type classes – type 1, type 2 and type 3 (previously B, C and D). These standards contain building regulations, requirements and tests for surge arrestors used in AC networks with nominal voltages of up to 1,000 V and nominal frequencies of between 50 and 60 Hz.

### Correct selection of the arrestor

This classification enables arrestors to be matched to different requirements with regard to location, protection level and current-carrying capacity. The table below provides an overview of the zone transitions. It also shows which OBO surge protection devices can be installed in the energy supply network and their respective function.

### Zone transitions

Zone transition	Protection device and device type	Product example	Product figure
LPZ 0 B to LPZ 1	Protection device for lightning protection equipotential bonding in accordance with DIN VDE 0185-3 for direct or close lightning strikes. <ul style="list-style-type: none"> <li>• Devices: type 1 (Class I, requirements class B), e.g. MC50-B</li> <li>• Max. protection level according to standard: 4 kV</li> <li>• Installation e.g. in the main distributor/at building entry</li> </ul>	MCD Item no.: 5096 87 9	
LPZ 1 to LPZ 2	Protection device for surge protection to DIN VDE 0100-443 for surge voltages arriving through the supply network due to remote strikes or switching operations. <ul style="list-style-type: none"> <li>• Devices: type 2 (Class II, requirements class C), e.g. V20-C</li> <li>• Max. protection level according to standard: 2.5 kV</li> <li>• Installation e.g. in the power distributor, subdistributor</li> </ul>	V20 Item no.: 5094 65 6	
LPZ 2 to LPZ 3	Protection device, designed for surge protection of portable consumers at sockets and power supplies. <ul style="list-style-type: none"> <li>• Devices: type 3 (Class III, requirements class D), e.g. FineController FC-D</li> <li>• Max. protection level according to standard: 1.5 kV</li> <li>• Installation e.g. on the end consumer</li> </ul>	FC-D Item no.: 5092 80 0	



## BET – testing centre for lightning protection, electrical engineering and support systems



Lightning current test

### BET with countless tasks

If only lightning current, environmental and electrical testing was possible at BET up to now, the BET Test Centre is now a competent partner for testing of cable support systems. This combination has made it necessary to revise the meaning of the name. If BET previously stood for "Blitzschutz- und EMV-Technologiezentrum" (Lightning protection and EMC technology centre), since 2009 these letters have meant BET Test centre for lightning protection, electrical engineering and support systems.

### Test generator for lightning current tests

The test generator planned in 1994 and completed in 1996 makes it possible to carry out lightning current tests at up to 200 kA. The generator was planned and constructed in cooperation with the Soest Technical College. Due to the intensive planning and scientific support in the construction of the test system, it has worked for 12 years without errors and meets current standardised test requirements.

### Testing tasks

The main load of the testing generator is generated through the testing of products from the TBS product division. For this, developmental tests of new developments, modifications to existing OBO products and also comparison tests with competitive products are carried out. These include lightning protection components, surge protection devices and lightning arrestors. Tests for lightning protection components are carried out according to DIN EN 50164-1, for spark gaps according to DIN EN 50164-3 and for lightning and surge protection devices according to DIN EN 61643-11. This is only a small amount of the testing standards used for tests in the BET Test Centre.





Load test

### Testing types for lightning and surge protection

Both lightning current tests and surge voltage tests can be carried out at up to 20 kV. A hybrid generator is used for these tests, which was also developed as part of a cooperation with the Soest Technical College. EMC testing of cable support systems can also be carried out using this test generator. All kinds of cable routing and cable support systems of up to 8 m length can be tested without any difficulties. Tests for electrical conductivity according to DIN EN 61537 are also carried out.

### Simulation of real environmental conditions

To carry out standardised tests on components intended for external use, they must be pretreated under real environmental conditions. This takes place in a salt spray trough and a sulphur dioxide testing chamber. Depending on the test, the test length and the concentration of the salt spray or sulphur dioxide in the testing chambers may vary. This means that it is possible to conduct tests according to IEC 60068-2-52, ISO 7253, ISO 9227 and EN ISO 6988.

### Testing cable support systems

The well-known KTS testing system, newly installed in the BET Test Centre, allows the investigation of the load capacities of any cable support system manufactured by OBO. The basis for this is DIN EN 61537 and VDE 0639. In the BET Test Centre, OBO Bettermann has a testing department in which products can be tested according to standards, even during the development phase.



# Planning aids, surge protection energy technology



Standards, surge protection	20
Installation instructions	21
4-cable networks	22
5-cable networks	23
Selection aid, energy technology	24





You must take various standards into account when erecting surge protection. You can find the most important specifications here.

Standard	Contents
<b>DIN VDE 0100-410 (IEC 60364-4-41)</b>	Low-voltage electrical installations – Part 4-41: Protection for safety – Protection against electric shock
<b>DIN VDE 0100-540 (IEC 60364-5-54)</b>	Low-voltage electrical installations – Part 5-54: Selection and erection of electrical equipment – Earthing arrangements, protective conductors and protective bonding conductors
<b>DIN VDE 0100-443 (IEC 60364-4-44)</b>	Low-voltage electrical installations – Part 4-44: Protection for safety – Protection against voltage disturbances and electromagnetic disturbances – Clause 443: Protection against surge voltages of atmospheric origin or due to switching
<b>DIN VDE 0100-534 (IEC 60364-5-53)</b>	Low-voltage electrical installations – Part 5-53: Selection and erection of electrical equipment – Isolation, switching and control – Clause 534: Devices for protection against surge voltages
<b>DIN EN 61643-11 (IEC 61643-1)</b>	Low-voltage surge protection devices – Part 11: Surge protection devices connected to low-voltage power systems – Requirements and tests

# Installation instructions

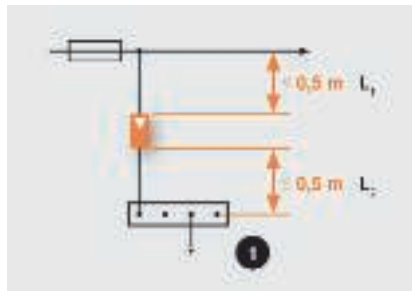

Length of the feed line, 1 = Equipotential bonding rail or terminal or protective conductor rail

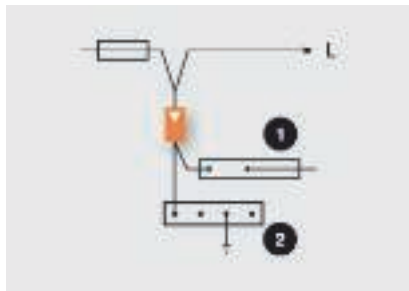

V wiring, 1 = Protective conductor rail, 2 = Main equipotential bonding rail or terminal

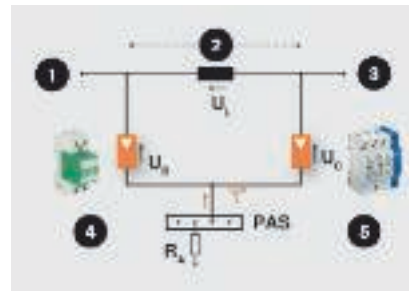

1= Power supply, 2 = Cable length, 3 = Consumer, 4 = Response voltage 2 kV, e.g. MC 50-B VDE 5 = Response voltage 1.4 kV, e.g. V20 C

## Minimum cross-sections for lightning protection equipotential bonding

The following minimum cross-sections must be observed for lightning protection equipotential bonding: for copper 16 mm<sup>2</sup>, for aluminium 25 mm<sup>2</sup> and for iron 50 mm<sup>2</sup>.

At the lightning protection zone, transition from LPZ0 to LPZ1, all metal installations must be integrated into the equipotential bonding system. Active lines must be earthed using suitable arrestors.

## Connection length, V-wiring

The connection cable to the protector is crucial for achieving an optimum protection level. In accordance with IEC installation directives, the length of the branch line to the arrestor and the length of the line from the protection device to the equipotential bonding should in each case be less than 0.5 m. If the cables are longer than 0.5 m, then V-wiring must be chosen.

## Decoupling

Lightning current and surge arrestors perform a number of functions. These arrestors must be used in coordination. This coordination is guaranteed by the existing line length or special lightning current arrestors (MCD series). For example, in the protection set, type 1 and type 2 arrestors (Classes B and C) can be used adjacent to each other.

### Example cable length > 5 m

- No additional decoupling required

### Example cable length < 5 m

- Use decoupling: MC 50-B VDE + LC 63 + V20-C
- Alternatively: MCD 50-B + V20-C, no additional decoupling required (e.g. protection set)

## Minimum dimensions of cables, protection class I to IV

Material	Cross-section of cables, which interconnect different equipotential bonding rails or which connect to the earthing system	Cross-section of cables, which connect the internal metallic installations with the equipotential bonding rail
Copper	16 mm <sup>2</sup>	6 mm <sup>2</sup>
Aluminium	25 mm <sup>2</sup>	10 mm <sup>2</sup>
Steel	50 mm <sup>2</sup>	16 mm <sup>2</sup>



## 4-cable networks, TN-C network system

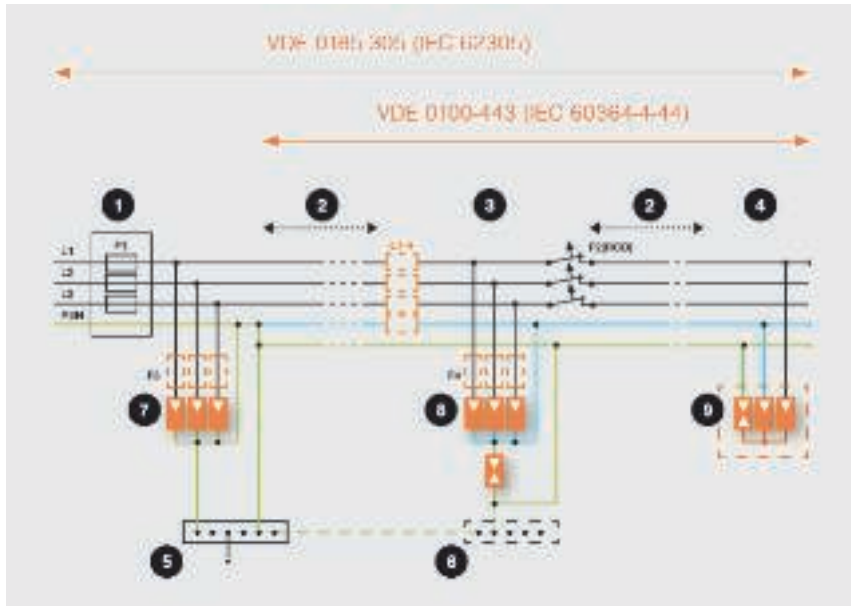

1 = Main distributor, 2 = Cable length, 3 = Circuit distributor, e.g. subdistributor, 4 = Fine power protection, 5 = Main EBS, 6 = Local EBS, 7 = Type 1, 8 = type 2, 9 = type 3

In the TN-C-S network system, the electrical unit is supplied through the three external lines (L1, L2, L3) and the combined PEN line. Usage is described in DIN VDE 0100-534 (DIN EN 61643-11).

### Lightning current arrester Type 1

Type 1 lightning current arresters are used in the 3-pole circuit (e.g.: 3x MC 50-B). The connection is effected parallel to the external lines, which are connected to the PEN via the arrester. Following consultation with the local energy provider and in accordance with the VDN Directive, use before the main meter device is also possible.

### Surge arrester, type 2

Surge arrestors of type 2 are usually used after the split in the PEN line. If the split is more than 0.5 m away, the network from here onwards is 5-line. The arrestors are used in the 3+1 circuit (e.g. V20-C 3+NPE). With the 3+1 circuit, the external lines (L1, L2, L3) are connected to the neutral cable (N) via arrestors. The neutral cable (N) is connected to the protective earth via a collective spark gap. The arrestors must be used before a residual current protective device (RCD), as it would otherwise interpret the surge current as a residual current and interrupt the power circuit.

### Surge arrester, type 3

Surge arrestors of type 3 are used to protect against surges in the device power circuits. These transverse surges occur primarily between L and N. A Y circuit protects the L and N lines with varistor circuits and makes the connections to the PE line through a collective spark gap (e.g. KNS-D). This protection circuit between L and N prevents surge currents from transverse voltages being conducted towards PE, the RCD thus interprets no residual current. The relevant technical data is contained on the product pages.

## 5-cable networks, TN-S and TT network system

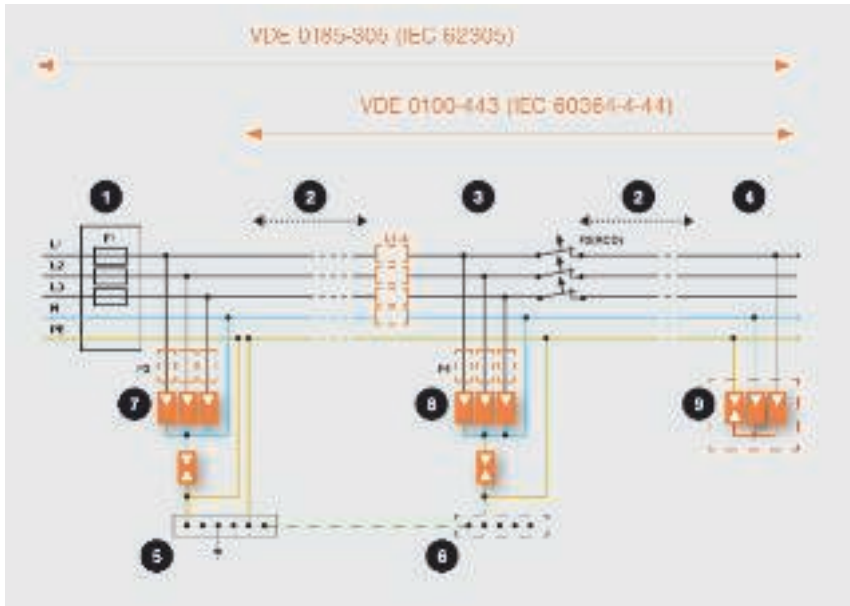

1 = Main distributor, 2 = Cable length, 3 = Circuit distributor, e.g. subdistributor, 4 = Fine power protection, 5 = Main EBS, 6 = Local EBS, 7 = Type 1, 8 = Type 2, 9 = Type 3

In the TN-S network system, the electrical unit is supplied through the three external lines (L1, L2, L3), the neutral cable (N) and the earth cable (PE). In the TT network, however, the electrical unit is supplied through the three external lines (L1, L2, L3), the neutral cable (N) and the earth cable (PE). Usage is described in DIN VDE 0100-534 (DIN EN 61643-11).

### Lightning current arrester type 1

Type 1 lightning current arrestors are used in the 3+1 circuit (e.g. 3x MC 50-B and one MC 125-B NPE). With the 3+1 circuit, the external lines (L1, L2, L3) are connected to the neutral cable (N) via arrestors. The neutral cable (N) is connected to the protective earth via a collective spark gap. Following consultation with the local energy provider and in accordance with the VDN Directive, use before the main meter device is also possible.

### Surge arrester, type 2

Surge arrestors of type 2 are used in the 3+1 circuit (e.g. V20-C 3+NPE). With the 3+1 circuit, the external lines (L1, L2, L3) are connected to the neutral cable (N) via arrestors. The neutral cable (N) is connected to the protective earth via a collective spark gap. The arrestors must be used before a residual current protective device (RCD), as it would otherwise interpret the surge current as a residual current and interrupt the power circuit.

### Surge arrester, type 3

Surge arrestors of type 3 are used to protect against surges in the device power circuits. These transverse surges occur primarily between L and N. A Y circuit protects the L and N lines with varistor circuits and makes the connection to the PE line through a collective spark gap (e.g. KNS-D). This protection circuit between L and N prevents surge currents from transverse voltages being conducted towards PE, the RCD thus interprets no residual current. The relevant technical data is contained on the product pages.













## Selection aid, energy technology

### AC combination arrester and surge protection; type 1+2, type 2 and type 3



**Installation location 2**  
**Installation in the subdistributor**  
**Medium protection / type 2**  
**Only required if distance  $\geq 10\text{m}$**

Description	Type	Item no.	Product figure
TN/TT Type 2 + 3 2.5 SU	V10 Compact	<b>5093380</b> Page: 200	
	V10 Compact-AS, with acoustic remote signalling	<b>5093391</b> Page: 200	
TN/TT Type 2 4 SU	V20-C 3+NPE	<b>5094656</b> Page: 179	
	V20-C 3+NPE+FS with remote signalling	<b>5094765</b> Page: 180	
TN/TT Type 2 4 SU	V20-C 3+NPE	<b>5094656</b> Page: 179	
	V20-C 3+NPE+FS with remote signalling	<b>5094765</b> Page: 180	
TN/TT Type 2 4 SU	VC20-C 3+NPE	<b>5094656</b> Page: 179	
	V20-C 3+NPE+FS with remote signalling	<b>5094765</b> Page: 180	

02\_TBS\_Masterkatalog\_Länder\_2012 / en / 29/05/2012 (LLExpert\_01433) / 29/05/2012



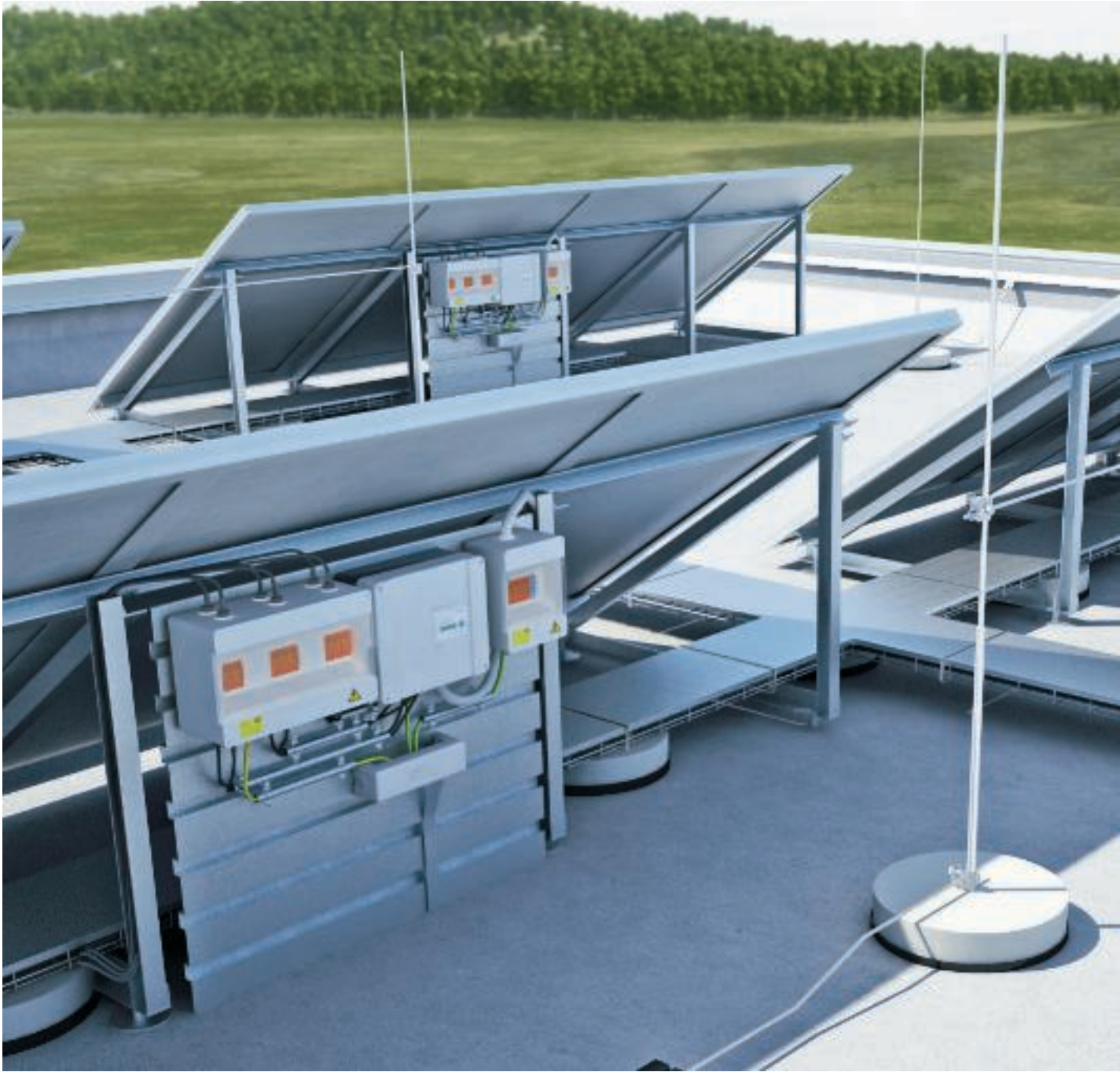

## Planning aids, contents lightning and surge protection, photovoltaics



Standards, photovoltaics	28
Responsibility	29
ProtectPlus	30
Coordinated protection	32
External lightning protection for sloping roof systems	34
External lightning protection for flat roof systems	35
Lightning protection equipotential bonding and separating distance	36
Planning aid, protective angle method	37
Planning aid, rolling sphere method	38
Four steps to comprehensive protection	39
DC surge protection energy technology, type 2	40
DC combination arrester, type 1+2 and data protection devices	41





Various standards must be complied with when erecting a photovoltaic system. You can find the most important European regulations here.

Standard	Contents
VDE 0185-305-1 (IEC 62305-1)	Protection against lightning – Part 1: General principles
VDE 0185-305-2 (IEC 62305-2)	Protection against lightning – Part 2: Risk management
VDE 0185-305-3 (IEC 62305-3)	Protection against lightning – Part 3: Protection of structures and people
VDE 0185-305-4 (IEC 62305-4)	Protection against lightning – Part 4: Electrical and electronic systems within structures
VDE 0185-305-3 Supp. sheet 5 (DIN EN 62305-3 Supp. sheet 5)	Protection against lightning – Part 3: Physical damage to structures and life hazard – Supplementary sheet 5: Lightning and surge protection for photovoltaic power supply systems
VDE 0675-11(IEC 61643-1)	Low-voltage surge protection devices – Part 11: Surge protection devices connected to low-voltage power systems
VDE 0100-534 (IEC 60364-5-53)	Low-voltage electrical installations - Part 5-53: Selection and erection of electrical equipment – Isolation, switching and control – Clause 534: Devices for protection against surge voltages
VDE 0100-443 (IEC 60364-4-44)	Low-voltage electrical installations – Part 4-44: Protection for safety – Protection against voltage disturbances and electromagnetic disturbances – Clause 443: Protection against surge voltages of atmospheric origin or due to switching
VDE 0100-712 (IEC 60364-7-712)	Requirements for operational premises, special rooms and systems - solar photovoltaic (PV) power supply systems

# Responsibility of the installation engineer and the operator of a photovoltaic system



## Photovoltaics working party:

“The overall responsibility for electrical safety is in the hands of the commissioner.”

The specialist company installing a PV system is required by law to hand it over in perfect condition.

The erection of a photovoltaic system often requires major intervention in the electrical infrastructure of a building. This is reflected in the wide range of standards and regulations to be complied with. The person erecting the system is liable for correct fulfilment for 30 years, and the requirements of the insurance company come on top of that.

## Responsibility of the erection engineer

Depending on the system type, the following standards must be complied with:

### Lightning protection

- VDE 0185-305-1 to -4
- VDE 0185-305-3 suppl. sheet 5
- IEC 62305-1 to -4

### Surge protection

- VDE 0100-433
- IEC 60364-4-44

### Low-voltage electrical installations

- VDE 0100-534
- IEC 60634-5-534
- VDE 0100-410
- IEC 60634-4-41
- VDE 0100-443
- IEC 60634-4-44

### Requirements for solar PV power supply systems

- VDE 0100-712
- IEC 60634-7-712
- VDE 0126-23
- IEC 62446

### Construction fire protection

- DIN 4102

Please observe the appropriate local and statutory requirements.

## Responsibility of the operator

Through the feed-in of the gained energy, almost every PV system is subject to the requirements for commercial use. For the system operator, this creates the obligation to give the system the proper maintenance, checking and repairs. These regular recurring checks of the electrical system components may only be carried out by an electrical technician.



With ProtectPlus, photovoltaic systems can beat storms, snow, rain, cold, sun and heat for decades.



Throughout their lifespan, photovoltaic systems are exposed to huge loads. Wind and weather take their toll on all the components of the system and lightning and surge voltages pose a major risk to the inverter. ProtectPlus can provide comprehensive protection of the entire system against damaging environmental influences.



### Protection against direct lightning strikes

The enormous energy of lightning can destroy PV systems in the blink of an eye, risking the economic viability of the entire system. Long-term monitoring – for example by BLIDS (Siemens lightning and information service, <http://blids.de>) – document a continuous increase in lightning levels and lightning strikes.



### Protection against surge voltage

On the alternating current side, the sensitive inverter is threatened by destructive surge voltages from switching operations and network couplings. Lightning strikes generate dangerous surge voltages in a radius of two kilometres. In the worst-case scenario, these voltage peaks are enough to damage the core of the system.



### Protection against environmental factors

Photovoltaic systems are suffering increasingly – meteorological observations show an increase in extreme weather conditions. Only a solidly executed installation can beat rain, snow, heat and cold throughout the lifespan of the system.



### Protection against mechanical loads

A PV system is exposed to different mechanical loads. Wind continuously batters all the outdoor system components, whereas snow places huge weights on the whole system. In the case of vertical cable routing, heavy loads occur, which must be supported using an appropriate strain relief.



### Protection against the spread of fires

Lightning protection for PV systems has various requirements: the spread of fires in the area of fire protection walls must be prevented, both outside and inside the building. In emergency and escape routes, the cable routing may not bring in any fire loads.



Coordinated protection. The ProtectPlus system kit.

## PROTECTPLUS



A well-thought-out system for the whole electrical infrastructure of a photovoltaic system – that's ProtectPlus. Different components provide comprehensive protection, which allows both the erection engineer and the system operator to sleep in peace.



### External lightning protection systems

Lightning currents are intercepted and run safely to the earth with the following systems:

- Interception rods
- Insulated lightning protection
- Insulated isCon® arrester
- Flat and round cables
- Cable bracket
- Connection terminals

### Earthing systems

Our products for perfect earthing:

- Flat and round cables
- Connector
- Connection terminals
- Earth entries
- Deep, ring and foundation earthers
- Corrosion protection







### Equipotential bonding systems

Equipotential bonding systems are the link between external lightning protection, surge protection and earthing. They are available in the following variants:

- For indoor use
- For outdoor use
- For industrial use



### Overvoltage protection systems

A product range for any application:

- Lightning arrester/combination arrester
- Surge protection for energy and data technology
- Complete system solutions, terminated and premounted in the housing
- Combination and surge arrester for photovoltaics, DC side



### Cable support systems

Quick-mounting, safe cable routing with:

- Cable trays
- Mesh cable trays
- Cable ladders
- Vertical ladders
- Suspended supports
- Wall and support brackets



### Cable routing systems

Tidy cable routing within the building can be achieved using

- Wall and ceiling ducts
- Cable and pipe fastening systems made of plastic and metal
- Screw-in and knock-in systems
- Rail systems



### Fire protection systems

Our fire protection system consist of the following components:

- Insulation
- Weatherproof fire protection bandages
- Systems for emergency and escape routes



## External lightning protection for sloping roof systems



### **Complete product range, decades of experience**

The inclusion of a photovoltaic system into the existing lightning protection concept of a building is often neglected during refitting work. This significantly increases the risk of considerable damage through a direct lightning strike.

For public buildings, for example, the LBO (state construction regulations) require a lightning protection system to protect people and provide protection against fires.

Our product range and our experience mean that we can offer the right solutions for almost any type of sloping roof. Amongst other things, it comprises:

- Interception rods
- Rod holders
- Ridge conductor holder
- Roof cable holder for ridge riles
- Roof cable holder for various roofing types
- Cable bracket
- Round and flat conductors

### **Four materials**

Our products are available in four different materials:

- Steel, hot-dip galvanised
- Copper
- Aluminium
- Stainless steel



*Conductor, connected with gutter clamp*

## External lightning protection for flat roof systems



Flat roof with PV system and insulated isCon® cable

### Lightning protection equipotential bonding system

Various points should be observed when arresting the lightning current. Metallic components without a conductive connection into the building must be connected directly to the lightning protection. Active DC/AC cables and data systems are included in the equipotential bonding using suitable lightning current and surge arrestors at the entry to the building. All metallic parts of a building and electrically powered equipment and their supply cable must be integrated into the lightning protection system.

### Separation distance

Air-conditioning systems, electrical sensors and photovoltaic systems are examples for roof structures in which the separation distance must be maintained. This distance is required to avoid dangerous sparking and lightning components between both the external lightning protection system and the metallic building parts and electrical devices.

In particular, when PV systems are refitted, this is often not possible due to the construction situation. Here, the insulated isCon® cable can help. The ideal solution with which a separation distance of 0.75 m through the air and 1.5 m for solid matter can be maintained.



Lightning protection equipotential bonding on the PV mounting system



# Lightning protection equipotential bonding system and separation distance



Figure 1: Separating distance (s) between the lightning protection system and cable support system

## Important measures

The following points must be taken into account to guarantee comprehensive protection of the PV system:

- Local earthing (PAS) must be connected to the main equipotential bonding (HPAS).
- Equipotential bonding cables must be routed close to and parallel with the DC cables.
- Data cables must be included in the protection concept.

You can find an overview of the protective measures in the table "Overview of protective measures".

## Separation distance

According to DIN EN 62305, the lightning protection system must be erected at a separation distance (s) from the parts of the PV system. Usually, a separation distance (s) (= safety distance) of 0.5 m to 1 m is sufficient.

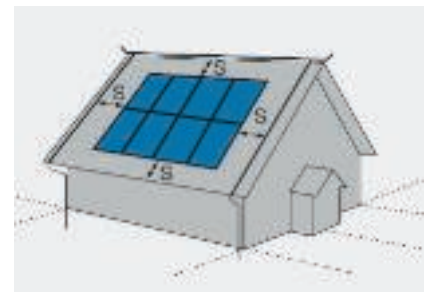

Figure 2: Separation distance (s) between the PV and the lightning protection system

# Planning aid, protective angle method

## Protective angle method for roof structures

You have protected the flat-roofed building correctly according to the standard VDE 0185-305 (IEC 62305). You must now protect all roof structures with interception rods. This involves observing the separating distance (s).

If the roof structure has a conductive continuation into the building (e.g. with a stainless steel pipe with a connection to the ventilation or air-conditioning system), then the separating distance (s) must always be maintained. The interception rod must be erected at a certain distance from the building to be protected. This distance safely prevents arcing of the lightning current and dangerous spark creation.



$\alpha^\circ$  = lightning protection angle, s = separating distance

## Roof structures with an individual air-termination rod

The protective angle for lightning rods varies according to lightning protection class. You can find the protective angle  $\alpha$  in the table for the most common interception rods of up to 2 m in length.

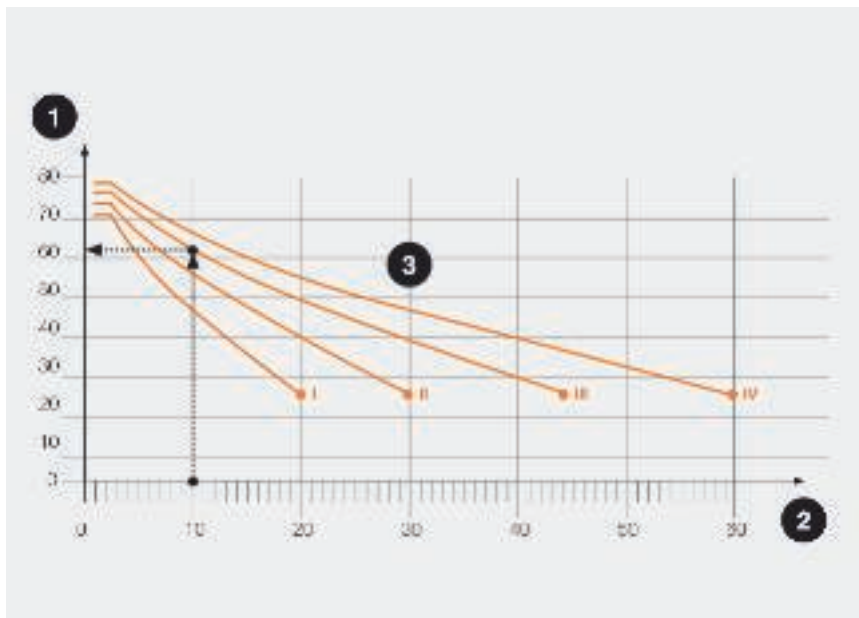

1 = Lightning protection angle  $\alpha^\circ$ , 2 = Ridge height h in m, 3 = Lightning protection classes I/II/III/IV

## Protective angle according to lightning protection class according to VDE 0185-305 (IEC 62305)

Lightning protection class	Protection angle $\alpha$ for interception rods to 2 m length
I	70°
II	72°
III	76°
IV	79°



## Planning aid, rolling sphere method



$p$  = penetration depth,  $R$  = radius of the lightning sphere,  $d$  = distance of the interception system



$$p = R - \sqrt{R^2 - \left(\frac{d}{2}\right)^2}$$

Formula for calculating the penetration depth ( $p$ )

### Roof structures with multiple interception rods

If you use several interception rods to protect an object, you must take into consideration the penetration depth between them. For a precise calculation, use the following formula:

### Penetration depth according to the lightning protection class according to VDE 0185-305

Distance of interception system ( $d$ ) in m	Penetration depth Lightning protection class I lightning protection sphere: $R = 20$ m	Penetration depth Lightning protection class II lightning protection sphere: $R = 30$ m	Penetration depth Lightning protection class III lightning protection sphere: $R = 45$ m	Penetration depth Lightning protection class IV lightning protection sphere: $R = 60$ m
2	0.03	0.02	0.01	0.01
3	0.06	0.04	0.03	0.02
4	0.10	0.07	0.04	0.04
5	0.16	0.10	0.07	0.05
10	0.64	0.42	0.28	0.21
15	1.46	0.96	0.63	0.47
20	2.68	1.72	1.13	0.84

# Four steps to comprehensive protection

### Step 1:

#### Check the separation distance

If the required separation distance cannot be complied with, then the metallic parts must be interconnected to be able to carry lightning current.

### Step 2:

#### Check the protection measures

Example: measures for lightning protection equipotential bonding are used on the DC and AC side, e.g. lightning arrestor (type 1).

### Step 3:

#### Include data cables









Data cables must be included in the protection concept.

### Step 4:

#### Carrying out the equipotential bonding

Local equipotential bonding must be provided on the inverter.



Overview of protection measures					
Initial situation	Measure	Separation distance according to DIN EN 62305 maintained	Equipotential bonding	Surge protection	Sample product picture
<ul style="list-style-type: none"> <li>External lightning protection system</li> </ul> (according to DIN EN 0185-305) 	Adapt the lightning protection system according to DIN EN 62305	Yes	min. 6 mm <sup>2</sup>	DC: Type 2	
				AC: Type 1	
		No	min. 16 mm <sup>2</sup>	DC: Type 1	
				AC: Type 1	
<ul style="list-style-type: none"> <li>No outside lightning protection system</li> <li>Earthing cable connection</li> </ul> 	Requirements' testing: LBO, Vds 2010, risk analysis, ...	-	min. 6 mm <sup>2</sup>	DC: Type 2	
				AC: Type 2	









## Selection aid Photovoltaics

---

You can find the selection aid for AC combination arrestors and surge protection in the chapter Surge Protection in Energy Technology.





Data technology						
Initial situation		RJ 45	Terminal	Type	Item no.	Product figure
	<ul style="list-style-type: none"> <li>No external lightning protection system</li> <li>Earthing cable connection</li> </ul>	●		ND-CAT6A/EA	<b>5081 80 0</b> Page: 250	
	<ul style="list-style-type: none"> <li>External lightning protection system (according to DIN EN 62305)</li> </ul>		●	FRD 24 HF	<b>5098 57 5</b> Page: 265	



# Planning aids, surge protection device for data and information technology



Standards, data and information technology	44
Important terms and basic principles	45
Network topologies	46
Installation instructions, lightning barriers	48
Limit frequency and installation instructions	50
Equipotential bonding of data cables	51
Terms and explanations on PC interfaces	52
Selection aids, surge protection	54



Various standards have a role in the field of data and telecommunications technology. From structured building cabling through equipotential bonding up to EMC, various different standards must be taken into account. Some important standards are listed here.

Standard	Contents
IEC 61643-21	Low voltage surge protective devices – Part 21: Surge protective devices connected to telecommunications and signalling networks. Power requirements and testing method.
DIN EN 50173-1	Information technology – Generic cabling systems – Part 1: General requirements
DIN VDE 0845-1	Protection of telecommunication systems against lightning, electrostatic discharges and surge voltages from electric power installations; provisions against surge voltages.
DIN VDE 0845-2	Protection of data processing and telecommunications equipment against the impact of lightning, discharge of static electricity and surge voltages from heavy current systems – Requirements and tests of surge voltage protection devices
DIN EN 50310 (VDE 0800-2-310)	Application of equipotential bonding and earthing in buildings with information technology equipment.
EN 61000-4-5 (VDE 08457-4-5)	Electromagnetic Compatibility (EMC) – Part 4-5: Testing and measurement techniques – Surge immunity test.
EN 60728-11 (VDE 855-1)	Cable networks for television signals, sound signals and interactive services – Part 11: Safety (IEC 60728-11:2005).

## Important terms and basic principles

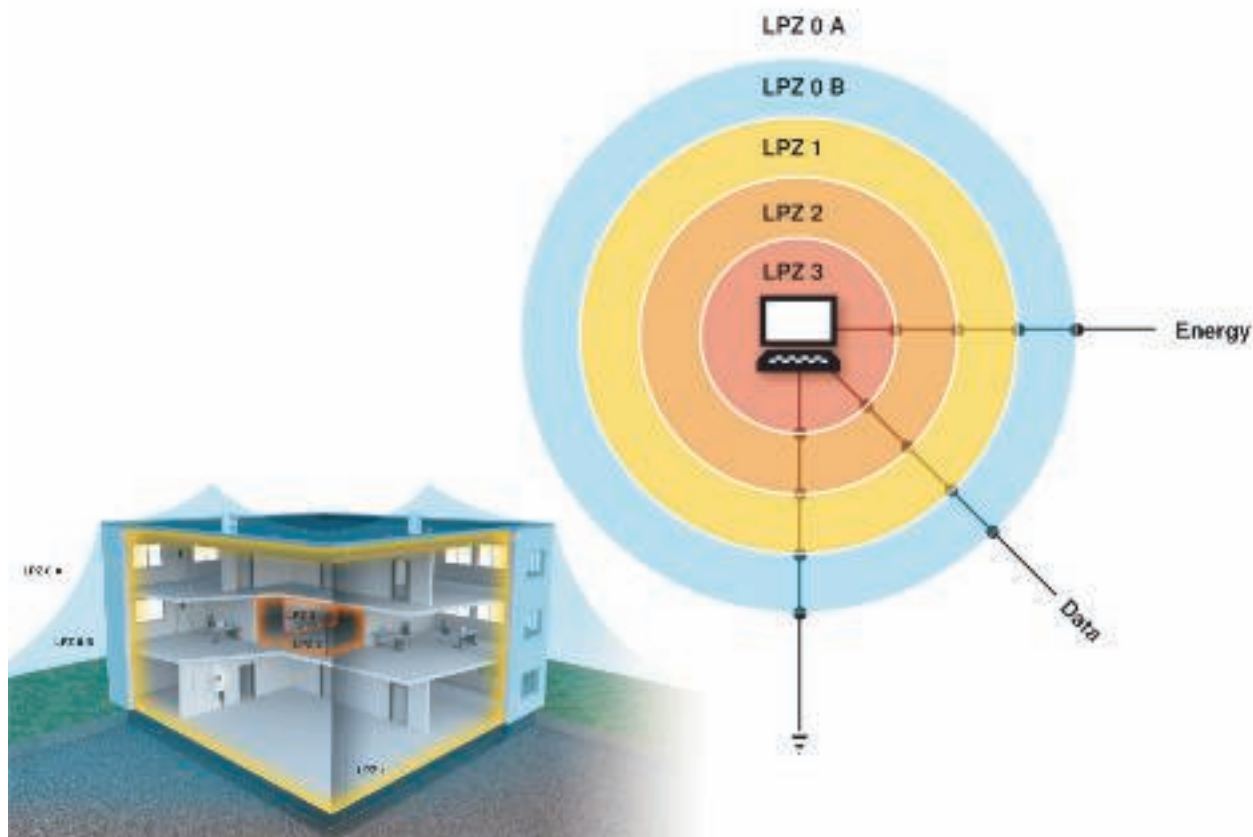

### Basic principles

These days, communication and IT systems are the lifelines of almost every company. In the worst-case scenario, surge voltages, caused by galvanic, capacitive or inductive couplings in data cables, can destroy IT equipment and communication technology. To avoid such failures, suitable protection measures have to be taken.

In practice, the wide range of standard information, telecommunication and measurement systems often makes the selection of the right surge protection device complex. The following factors must be taken into account:

- The connection system of the protection device must fit the device to be protected.
- Parameters such as the highest signal level, highest frequency, maximum protection level and the installation environment must be taken into account.
- The protection device may only exert the minimum of impacts, such as attenuation and

reflection, on the transmission path.

### Protection principle

A device is only protected against surge voltages if all energy and data cables connected to the device are integrated into the equipotential bonding system at the lightning protection zone transitions (local equipotential bonding). OBO Bettermann offers a complete range of tried-and-tested, highly functional and reliable data cable protection devices for all standard telecommunication and information technology systems.





## Network topologies

### Bus topology

In a bus topology, all users are connected in parallel. At its end, the bus must have an anechoic closure. Typical applications are 10Base2, 10Base5 and machine controllers such as PROFIBUS and telecommunication systems such as ISDN.

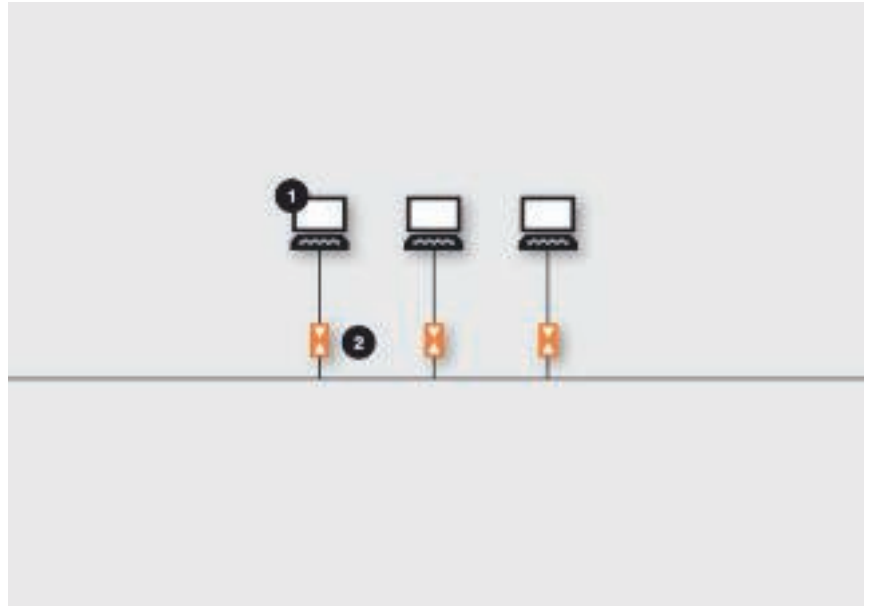

1 = IT devices, 2 = Surge protection devices

### Star networks

In a star network, every workstation is supplied by a separate cable from a central star point (HUB or Switch). Typical applications are 10BaseT and 100BaseT.

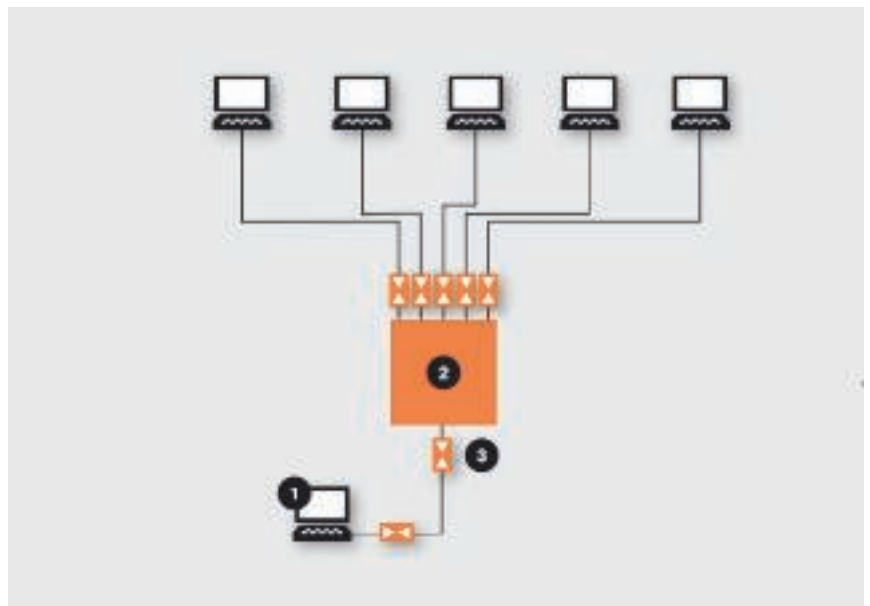

1 = Server, 2 = Switch/Hub, 3 = Surge protection devices

# Network topologies and connection types

## Ring topology

In a ring topology, every workstation is connected to precisely one predecessor and one successor via a ring-shaped network. If one station fails, the entire network fails. Ring networks, e.g. in Token Ring applications.

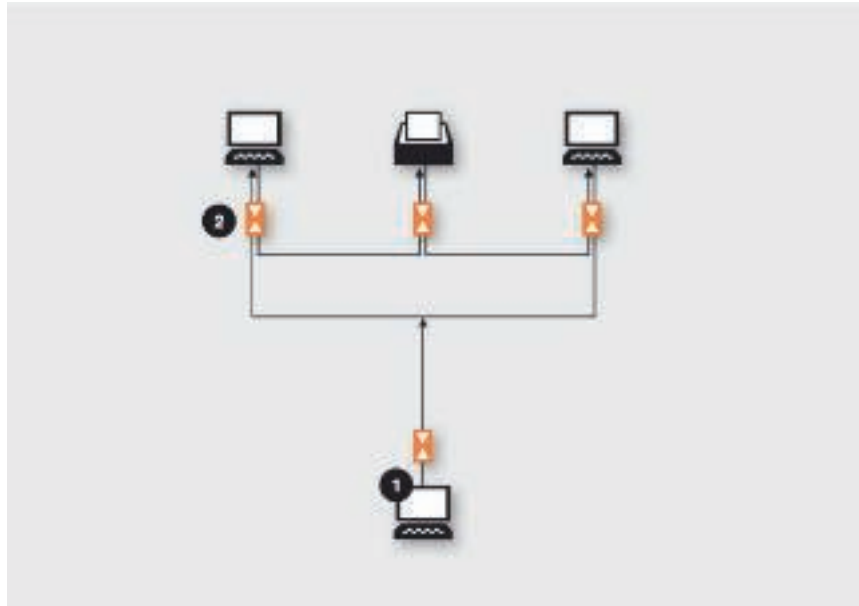

The number of wires varies according to the network type. 1 = Server, 2 = Ground floor

## Telephone systems

In many cases, modern telephone systems also act as interfaces for a number of different data services, e.g. the Internet. Many terminal devices that enable this access are connected into the lines themselves and must be integrated into the surge protection concept accordingly. As there are now a number of different systems, these devices must have selective protection. There are three distinctly different essential systems:

### Standard analogue connection

Unlike other systems, the standard analogue connection offers no additional services. One or several telephones are wired in a star-shape and ring simultaneously when a call comes in. Access to the Internet is via a separate modem. Because the analogue connection without technical accessories provides only one channel, the Internet cannot be accessed while telephoning and likewise, no telephone call is possible while surfing.

## ISDN (Integrated Services Digital Network System)

In contrast to the analogue connection, ISDN allows two conversations to take place at the same time via a special bus system (S0 bus), which provides two channels. This enables the user to surf on the Internet while telephoning and at higher data rates than is possible with the analogue connection (64 kBit/s over one channel). ISDN also offers other services such as call-waiting, call-back, etc.

## DSL system (Digital Subscriber Line)

Today, the most commonly used system is the DSL system. Speech and data channels are separated by splitters and the data channel is routed to a special modem (NTBBA), which is connected to the PC via a network card. DSL data rates are higher than those of analogue and ISDN systems and therefore enable fast downloading of music and films from the Internet. Because there are a number of different DSL versions such as A-DSL and S-DSL, the general DSL is also designated X-DSL. X-DSL permits the use of analogue telephones without additional hardware, as well as a combination with ISDN.





## Type differences, lightning barriers

### FRD/FLD

Lightning barriers TKS-B, FRD, FLD, FRD 2 and FLD 2 protect electronic measuring, controlling and regulating systems from surges. Lightning barriers of type MDP are used in areas requiring particularly small installation widths with simultaneously high numbers of poles.

Type FRD, FLD and MDP lightning barriers are designed for use in so-called floating (asymmetrical, potential-free) two-core systems. These are systems whose signal circuits have no common reference potential with other signal circuits, e.g. 20 mA current loops. These devices can be used universally.

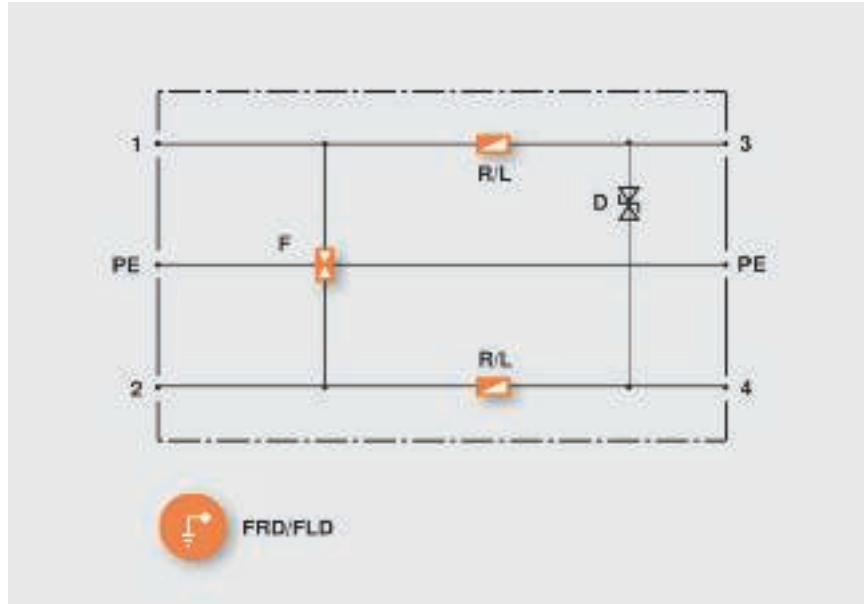

Circuit diagram of the lightning barrier FRD/FLD

### FRD2/FLD2

Type FRD2 and FLD2 are intended for use in ground-referenced (symmetrical, potential-referenced) single-wire systems.

Earth-referenced systems are signal circuits that have a common reference potential with other signal circuits. In these systems, two further data cables besides earth are protected. The decision to use FRD (with resistive decoupling) or FLD (with inductive decoupling) depends on the system to be protected.

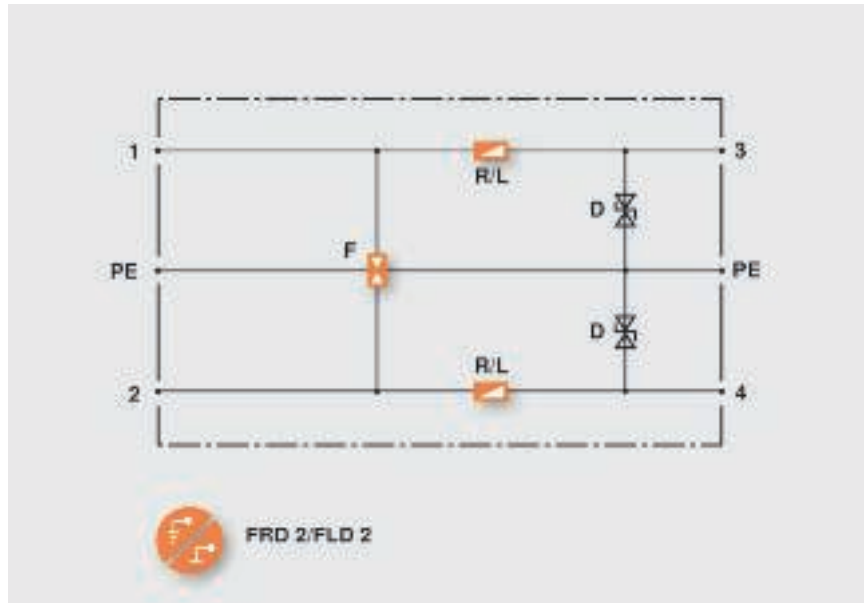

Circuit diagram of the lightning barrier FRD2/FLD2



# Lightning barriers in measurement circuits and terms for HF technology

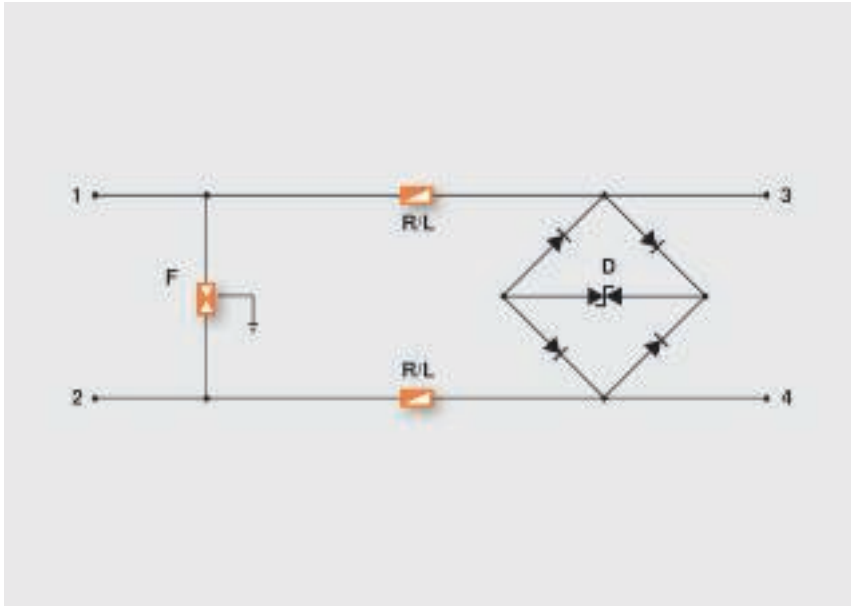

Basic protection circuit in measuring circuit

## Use of lightning barriers in measuring circuits

Before lightning barriers are used in measuring circuits, it must first be confirmed whether a resistance increase is permitted. Depending on the decoupling, resistance increases in the measuring circuits can occur with types FRD and FRD2. This can result in errors with current loop measurements. FLD/FLD2 and/or MDP devices should therefore be used in this case. The maximum operating current should also be verified to ensure that the dissipated energy does not cause thermal destruction of the decoupling elements.

In the case of arrestors with integrated inductivities for decoupling, the signal is attenuated at high transfer frequencies. Therefore, when used in measuring circuits with high transfer frequencies, lightning barriers with resistive decoupling elements are the preferred solution.

## Insertion loss

Insertion loss describes the damping of a system from input to output. It shows the transfer function of the system and accommodates the 3 dB point (see figure Limit frequency).

## Return loss

This parameter indicates in dB how much input power is reflected back. In 50  $\Omega$  systems, these values are around -20 dB. This value is important for antenna systems. In the case of arrestors with integrated inductivities for decoupling, the signal is damped at high transfer frequencies. Therefore, when used in measuring circuits with high transfer frequencies, lightning barriers with resistive decoupling elements are the preferred solution.





## Terms for HF technology and installation instructions

### Cut-off frequency $f_g$

The cut-off frequency  $f_g$  describes the frequency-dependent behaviour of the arrester. Capacitive and/or inductive component properties ensure signal damping at higher frequencies. The critical point is described as the cut-off frequency  $f_g$ . From this point onwards, the signal has lost 50% (3 dB) of its input power. The cut-off frequency is determined according to certain measuring criteria. Usually, in the absence of any values, the cut-off frequency relates to so-called 50  $\Omega$  systems.

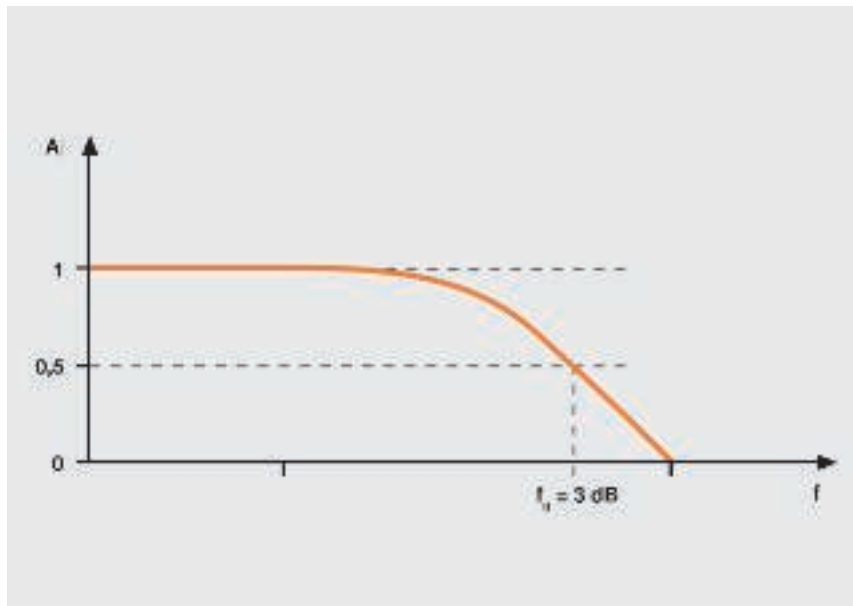

Attenuation curve in the Bode diagram

### Installation instructions

The surge protection device must be connected as close as possible to the device to be protected. The housing of the device to be protected should if necessary be defined as a local earthing point. In addition, care should be taken to ensure short PE line distances from surge protection device to earthing point (housing) – line length max. 0.5 m.

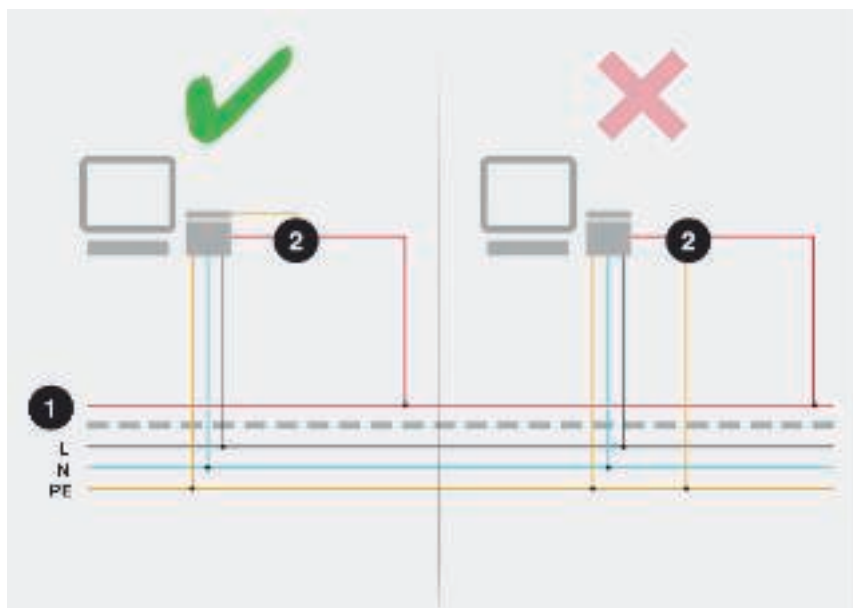

Installation information: 1 = ISDN, 2 = Protection device

# Equipotential bonding of data cables

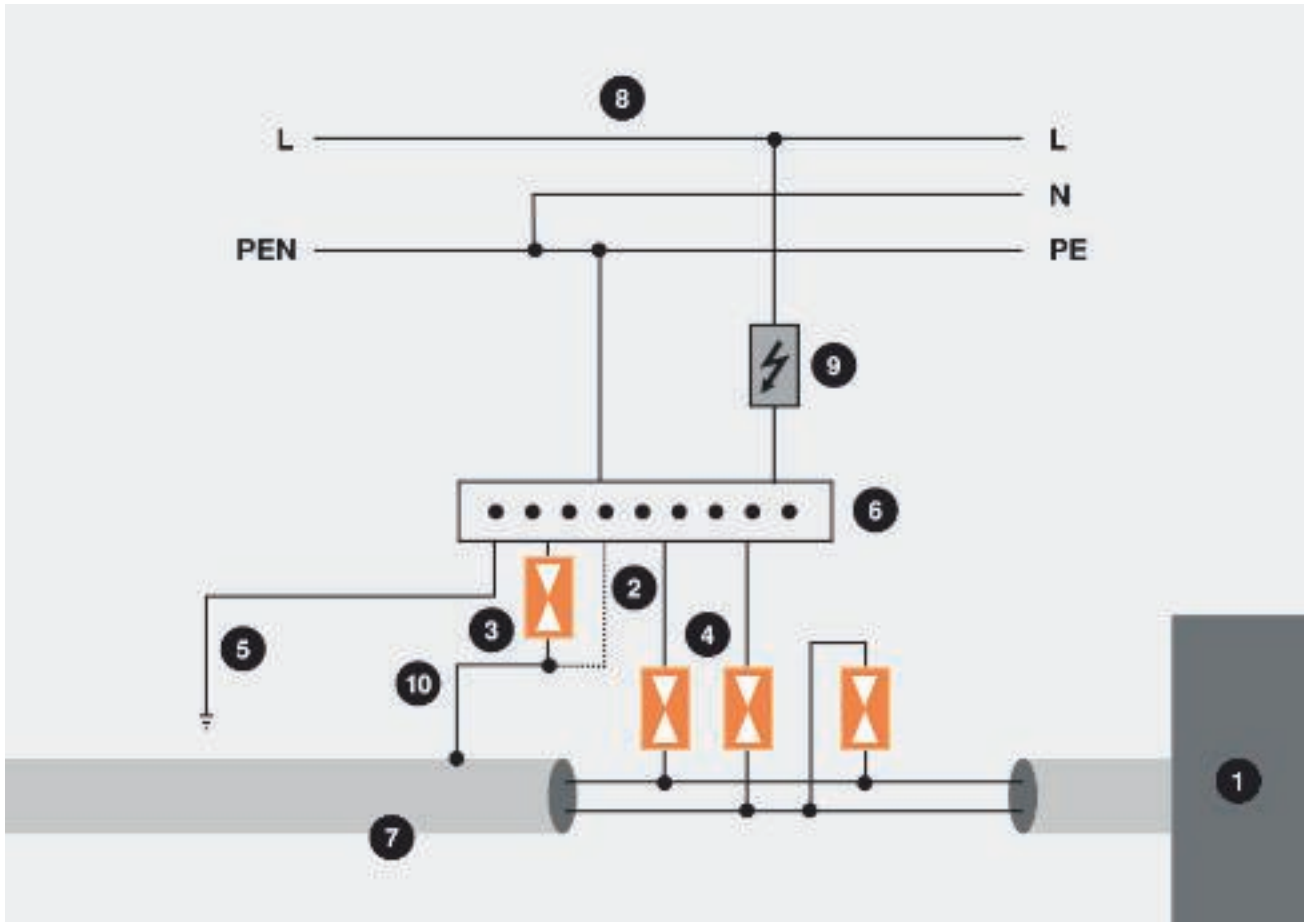

## Equipotential bonding of data cables

In contrast to energy technology, data technology has lengthwise and transverse voltages, which must be minimised using suitable arrestors with voltage-limiting components.

To achieve low protection levels, these surge protection devices must be included in the equipotential bonding via the shortest route. Long cable routes should be avoided. The best solution is local equipotential bonding.

The inclusion of the shields is also of key importance. Complete shield action against capacitive and inductive coupling can only be effective when the shield is included with low impedance on both sides in the equipotential bonding.

1	Device to be protected/telecom line
2	Direct connection to equipotential bonding (preferred)
3	Gas discharge arrestor (indirect shielding)
4	Gas discharge arrestor
5	Connection to equipotential bonding
6	Equipotential bonding rail
7	Telecommunications line
8	Electrical energy cable
9	Surge protection device (energy technology)
10	Conductive shield of the data cable



## Terms and explanations for PC interfaces

### Interfaces

External devices such as printers, scanners and control systems activated via serial or parallel interfaces must be additionally integrated into the surge protection concept.

#### RS232 interface

The RS232 is a frequently used interface. It is often used, for example, for modems and other peripherals. Although now largely replaced by the USB interface, the RS232 standard is still frequently used for control cables.

#### TTY system

Unlike the RS232 or other serial interfaces, the TTY system is not voltage-controlled - instead it delivers an imposed current (4-20 mA). This enables cable lengths of up to several hundred metres to be realised.

There is a range of interfaces for different applications: from bus lines for telecommunication and data transfer through to simple terminal devices such as printers or scanners. OBO also offers a host of protective devices that are simple to install, depending on the particular application.



#### RS422

The RS422 is a serial high-speed standard suitable for communication between a maximum of ten users, which is designed as a bus. The system can be designed for a maximum of eight data cables, although two are always used as send and receive cables.

#### V11 interface

V11 is the German designation for the RS422. The American nomenclature, however, is the most widely used.

#### RS485 interface

The RS485 industrial bus interface differs slightly from the RS422 in that the RS485 enables the connection of several transmitters and receivers (up to 32 users) via a protocol. The maximum length of this bus system, when twisted-pair cables are used, is approx. 1.2 km with a data rate of 1 MBit/s (dependent upon serial controllers).

#### V24 interface

V24 is the German designation for the RS232. The American nomenclature, however, is the most widely used.





Planning aids, surge protection device for data and information technology



# Selection aid

## Telecommunications systems



Planning aids, surge protection device for data and information technology













Planning aids, surge protection device for data and information technology

## Selection aid MSR systems



**Installation location 2  
Protection on the sensor**

Description	Type	Item no.	Test mark	Product figure
Protection of up to 10 two-core wires (select appropriate accessories) (please order connection strip 5084008 as well)	LSA-MAG	<b>5084 02 0</b> Page: 241		
2-wire protection for high peak currents	TKS-B	<b>5097 97 6</b> Page: 265		
4-wire protection with test function	MDP-4/D-24-T	<b>5098 43 1</b> Page: 275	UL	
4-wire protection with test function	MDP-4/D-24-T	<b>5098 43 1</b> Page: 275	UL	
2-wire protection	FLD 24	<b>5098 60 3</b> Page: 269	UL	
2-wire protection for HF applications	FRD 24 HF	<b>5098 57 5</b> Page: 265	UL	
2-wire protection for high peak currents	TKS-B	<b>5097 97 6</b> Page: 265		
4-wire protection with test function	MDP-4/D-24-T	<b>5098 43 1</b> Page: 275	UL	
Protection of RS232 applications	SD25-V24 25	<b>5080 27 4</b> Page: 255		

02\_TBS\_Masterkatalog\_Länder\_2012 / en / 29/05/2012 (LLExpert\_01433) / 29/05/2012











Planning aids, surge protection device for data and information technology

## Selection aid MSR systems

**Installation location 2  
Protection on the sensor**

Description	Type	Item no.	Test mark	Product figure
4-wire protection with test function and nominal currents up to 10 A	MDP-4/D-24-T	<b>5098 43 3</b> Page: 279	UL	
2-wire protection without testing point	TKS-B	<b>5097 97 6</b> Page: 265		
Intrinsically safe surge protection for 3 cables in the housing (metric thread)	FDB-3-24-M	<b>5098 38 2</b> Page: 282	Ex	
Intrinsically safe surge protection for 3 cables in the housing (NPT thread)	FDB-3-24-N	<b>5098 39 2</b> Page: 282	Ex	
4-wire protection to 5 V, Ex tested	MDP-4/D-5-EX	<b>5098 41 2</b> Page: 284	Ex	
4-wire protection to 24 V, Ex tested	MDP-4/D-24-EX	<b>5098 43 2</b> Page: 284	Ex	
4-wire protection to 48 V, Ex tested	MDP-4/D-48-EX	<b>5098 45 2</b> Page: 284	Ex	

02\_TBS\_Masterkatalog\_Länder\_2012 / en / 29/05/2012 (LLExpert\_01433) / 29/05/2012



## Selection aid Data technology / network technology



Planning aids, surge protection device for data and information technology

**Installation location 2  
Protection on the terminal**

Description	Type	Item no.	Product figure
-------------	------	----------	----------------

Data cable protection for channel CLASS EA	Net Defender	<b>5081 80 0</b> Page: 250	
--	--------------	-------------------------------	---



Data cable protection for channel up to Class D	RJ45-ATM/8-F	<b>5081 79 3</b> Page: 250	
---	--------------	-------------------------------	---



Fine protection with BNC connection (Class C)	CoaxB-E2/MF-F	<b>5082 42 0</b> Page: 250	
---	---------------	-------------------------------	---



Fine protection for 230 V power supply, connectable	FC-D	<b>5092 80 0</b> Page: 210	
---	------	-------------------------------	---



Fine protection for hat rail installation	VF 230-AC/DC	<b>5097 65 0</b> Page: 215	
---	--------------	-------------------------------	---





Planning aids, surge protection device for data and information technology

## Selection aid Antennas



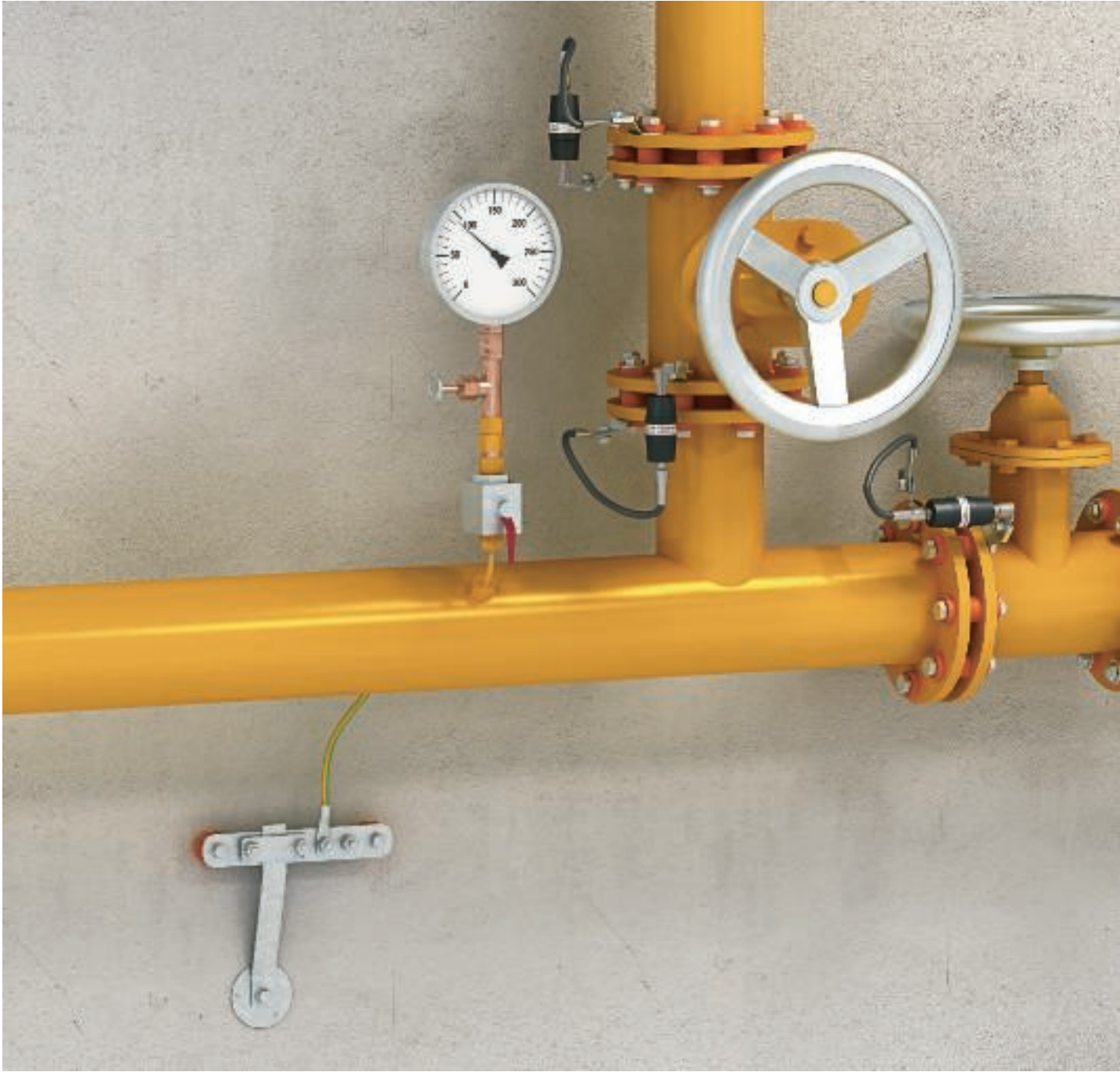



# Planning aids, protection and spark gaps



Protection and spark gaps/ATEX approval	66
Installation principle for protection and spark gaps	67





### Task

OBO isolating and protective spark gaps are designed to isolate electrical system components, which under normal operating conditions are not connected together. If lightning strikes cause a potential increase in one of the electrical system components, the isolating spark gap guarantees a conductive connection and therefore equipotential bonding.







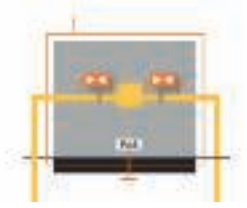

### Function

As their name suggests, isolating and protective spark gaps comprise a spark gap. This gap transfers from the insulating to the current-permeable condition when an electric arc is ignited by a surge voltage. An isolating spark gap differs from a protective spark gap in its purpose for use. Isolating spark gaps isolate varying earth potentials, while the protective spark gaps are used only in roof standard open-wire lines.

### Applications

- For producing an indirect connection between insulating flanges (cathodic corrosion protection).
- For bridging insulating flanges, also in ex-protected areas (tested in accordance with ATEX Directive 94/9/EC).
- Avoidance of drag in residual voltages, especially TT systems.
- For lightning protection equipotential bonding according to DIN VDE 0185-305 (IEC 62305).
- For connecting different earthing systems, the aim being to make optimum use of all earthers for lightning protection equipotential bonding.
- As a measure that saves isolating connections for measuring and test purposes.

# Installation principle for protection and spark gaps

Overview				
Application	Description	Type	Item no.	Product figure
Isolating spark gaps for insulating flange 	<ul style="list-style-type: none"> <li>e.g. in a gas pressure control station</li> <li>Particularly for Ex areas</li> <li>For bridging of insulating flanges or insulating threaded joints which can carry lightning currents</li> </ul>	Type 480	<b>5240034</b> <b>5240077</b> <b>5240069</b>	
Isolating spark gaps for potential isolation 	<ul style="list-style-type: none"> <li>Several earthing systems in one building, e.g. foundation earther and deep earther</li> <li>Connection via spark gap</li> <li>N electrochemical corrosion</li> <li>Entire earther surface is effective in the event of a direct lightning strike</li> </ul>	Type 481	<b>5240085</b> Page: 288	
Open-wire connection 	<ul style="list-style-type: none"> <li>Roof stand spark gap for insulation</li> <li>Largest possible distance between the roof stand of a low voltage free cable and a lightning protection system</li> <li>Distance &lt; 0.5 m: encapsulated spark gap in agreement with the power supply company</li> </ul>	Type 482	<b>5240050</b> Page: 289	
Coupling of earthing systems 	<ul style="list-style-type: none"> <li>Several earthing systems on one building</li> <li>If the operation of special electronic equipment requires a separate earthing system, then this functional earth must be connected to the operating earth</li> <li>Prevention of dangerously high voltage differences</li> <li>An additional throttle is fitted to keep high-frequency voltages away from the functional earthing</li> </ul>	Type FS-V20	<b>5099803</b> Page: 289	









Life Control testing unit

### Testing surge protection devices within data cables

Often, it is necessary to check the functionality of the surge protection devices within the data cable. Of particular importance is that the actual testing of the protection devices has no negative impact on the data signal.

### Testing of the arrester upper parts V50, V25, V20 and V10

The ISOLAB testing unit allows the checking of the arrester upper parts V50, V25, V20 and V10. A rotary controller allows the selection of the appropriate OBO Bettermann arrester. Then, the upper part of the appropriate combination and/or surge arrester is placed in the appropriate opening in the device. The function of the varistor is then checked by pressing the test button. Besides arrester testing, the ISOLAB also allows insulation testing according to VDE 0100-610.



ISOLAB testing device

The Life Control testing unit, developed by OBO Bettermann, allows testing of the protection devices when installed, without influencing the data signal. A thin testing pin creates the contact with the integrated lightning barrier. The integrated microprocessor displays the test result on the OLED display and also emphasises it with acoustic signals. A connectable LED within the testing pin is an additional feature, allowing orientation, even in the darkest switchgear cabinet.

A high-quality testing case for safe transport and the documentation of the testing results are a component part of this innovation from OBO Bettermann.



### Testing of lightning protection systems with the PCS system

The peak current sensor (PCS) records and stores pulsed currents in the form of a magnetic card. This is a method of monitoring whether lightning has hit the lightning protection and which maximum lightning current has occurred.

If the PCS system is mounted between the interface from equipotential bonding to earthing system, the coupled lightning current in a building can also be measured. The results can provide informa-

tion on potential damage in the electrical installation. The PCS card is mounted by snapping a card holder onto the round conductor at a defined distance. The measuring range of the card is between 3 and 120 kA. The magnetic card reader offers the option of evaluating peak current sensors. The appropriate peak current value is shown on the display. Alternatively, OBO Bettermann can read it off for you. In this case please contact your OBO Bettermann agency or subsidiary.







# Planning aids, equipotential bonding systems



# Equipotential bonding planning



You must take various standards into account when erecting equipotential bonding systems. You can find the most important specifications here.

Standard	Contents
<b>DIN VDE 0100-410</b> <b>(IEC 60364-4-41)</b>	Low-voltage electrical installations Part 4-41: Protection for safety – Protection against electric shock
<b>DIN VDE 0100-540</b> <b>(IEC 60364-5-54)</b>	Low-voltage electrical installations Part 5-54: Selection and erection of electrical equipment – Earthing arrangements, protective conductors and protective bonding conductors
<b>DIN 18014</b>	Foundation earthers
<b>DIN VDE 0100-534</b>	Low-voltage electrical installations Part 5-53: Selection and erection of electrical equipment – Isolation, switching and control – Clause 534: Devices for protection against surge voltages
<b>VDE 0185-305-3</b> <b>(DIN EN 62305-3)</b>	Protection of buildings and humans
<b>VDE 0185-305-4</b> <b>(DIN EN 62305-4)</b>	Electrical and electronic systems within structures

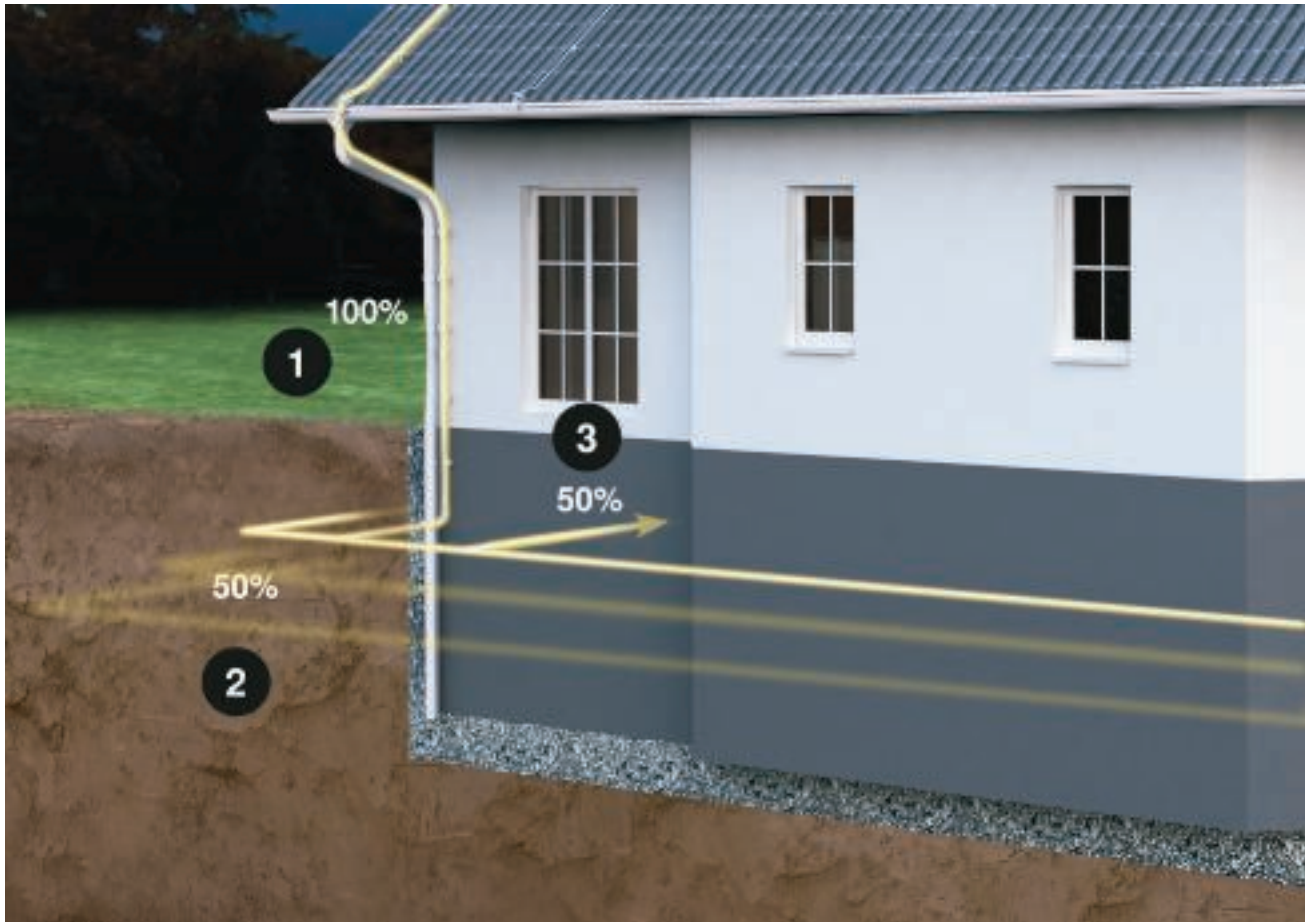

Path of the lightning current: 1 = 100%, 2 = 50%, 3 = max. 50%

### Tasks and function of internal lightning protection

The task of an internal lightning protection system is to prevent dangerous sparking within the building to be protected. Sparking can occur especially when high potential differences with metallic or electrically operated system components occur due to a conductor (arrestor) passing from the lightning current. Electrical energy and information technology systems in particular require special protection, as a direct connection between the external lightning protection system and the building installation exists via the earthing system and the equipotential bonding. In order to avoid damage inside the building, a lightning protection equipotential bonding in accordance with DIN EN 62305 (IEC 62305) is necessary.

tection equipotential bonding in accordance with DIN EN 62305 (IEC 62305) is necessary.

### System components to be connected

In addition, the following system components must be connected to the equipotential bonding:

- Metal carcass of the structure
- Metal installations
- External conductive components
- Electrical energy and information technology systems

### Installing the equipotential bonding

The equipotential bonding should be installed at the basement or at

ground level. The electrical energy and information technology lines must be connected to the equipotential bonding via type 1 lightning current arrestors. The arrestors must be connected to the equipotential bonding as close as possible to where the lines enter the building. The surge arrester connection must comply with DIN VDE 0100-534. The following cross-sections apply as minimum dimensions for connections in the lightning protection equipotential bonding (unless larger cross-sections are specified in other standards):

- Copper: 16 mm<sup>2</sup>
- Aluminium: 25 mm<sup>2</sup>
- Steel: 50 mm<sup>2</sup>

### Minimum dimensions of cables, protection class I to IV

Material	Cross-section of cables, which interconnect different equipotential bonding rails or which connect to the earthing system	Cross-section of cables, which connect the internal metallic installations with the equipotential bonding rail
Copper	16 mm <sup>2</sup>	6 mm <sup>2</sup>
Aluminium	25 mm <sup>2</sup>	10 mm <sup>2</sup>
Steel	50 mm <sup>2</sup>	16 mm <sup>2</sup>





# Planning aids, earthing systems



Installation principle, deep earther	78
Installation principle, ring earther	79
Selection aid, ring earthers	80
Installation principle, foundation earther	82
Selection aid, foundation earthers	83
Decision-making aid, grid width	84

## Installation principle, deep earther

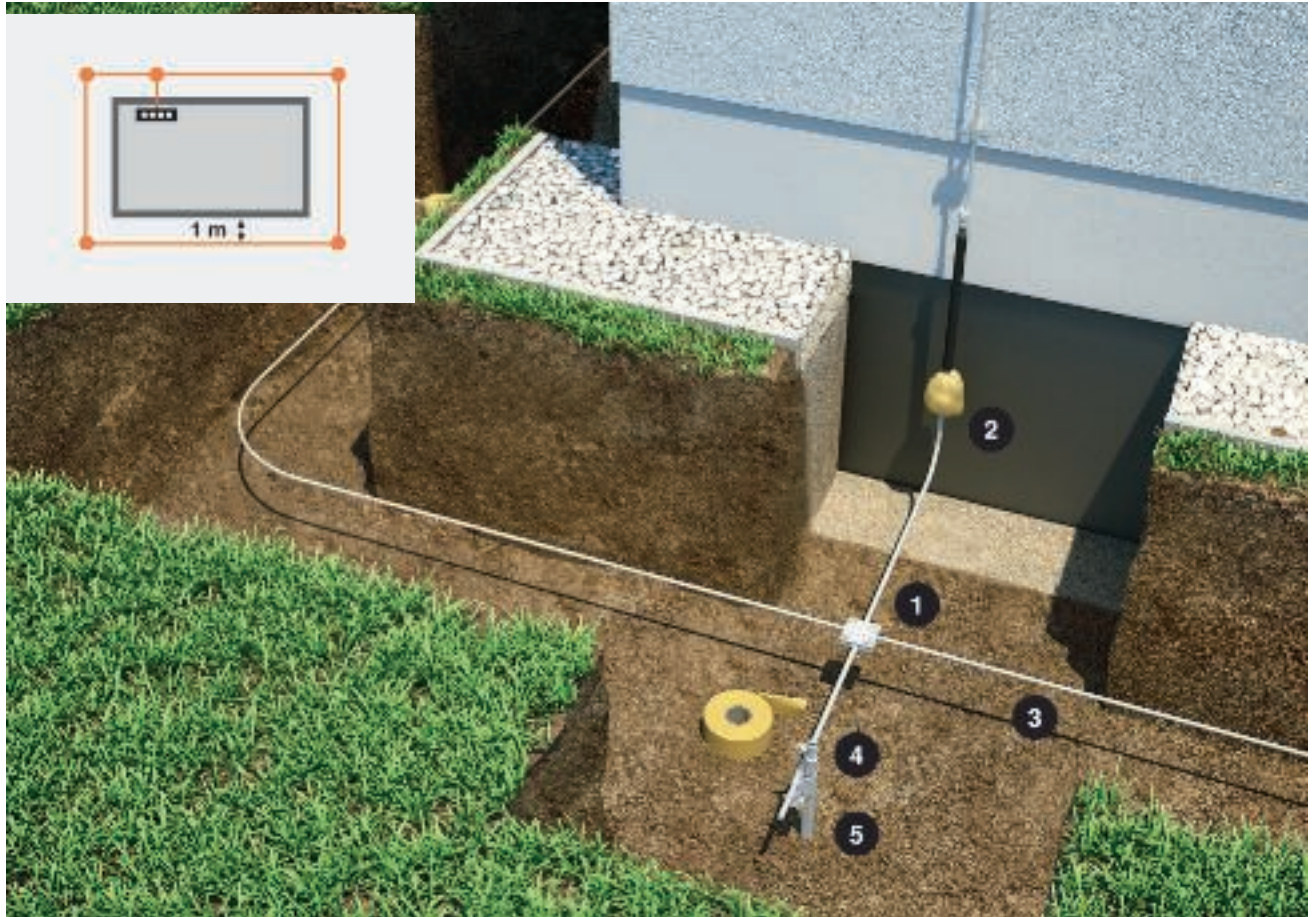

1 = Cross-connectors, 2 = Corrosion protection strip, 3 = Round cables, 4 = Connection terminals, 5 = Earthing rod, (observe corrosion protection for connectors)

### Functional method

As single earthers, a deep earther of 9.0 m in length is recommended. This should be installed at a distance of 1.0 m from the foundation of the building. As a minimum dimension (according to DIN VDE 0185 Part 3 Fig. 3), a length of 2.5 m for vertical installation and 5 m for horizontal installation apply for type A earthers for lightning protection classes III and IV. The required earther lengths may be split into several lengths connected in parallel. Depending on the soil conditions, deep earthers can be driven into the earth by hand or using suitable electric, petrol or pneumatic hammers.

All deep earthers must be connected with a ring earther inside or outside of the building and with a lead to the equipotential bonding rail.

### Materials

The following materials can be used:

- Rods made of galvanised steel, Ø 20 mm
- Rods made of stainless steel, Ø 20 mm
- Pipes made of galvanised steel, Ø 25 mm (2 mm wall thickness)
- Flat conductors made of galvanised steel 30 x 3.5 mm
- Flat conductors made of stainless steel 30 x 3.5 mm

### Corrosion protection

In potentially corrosive areas, stainless steel must always be used. Detachable connections in the ground must be protected against corrosion (plastic corrosion protection strip).

## Installation principle, ring earther

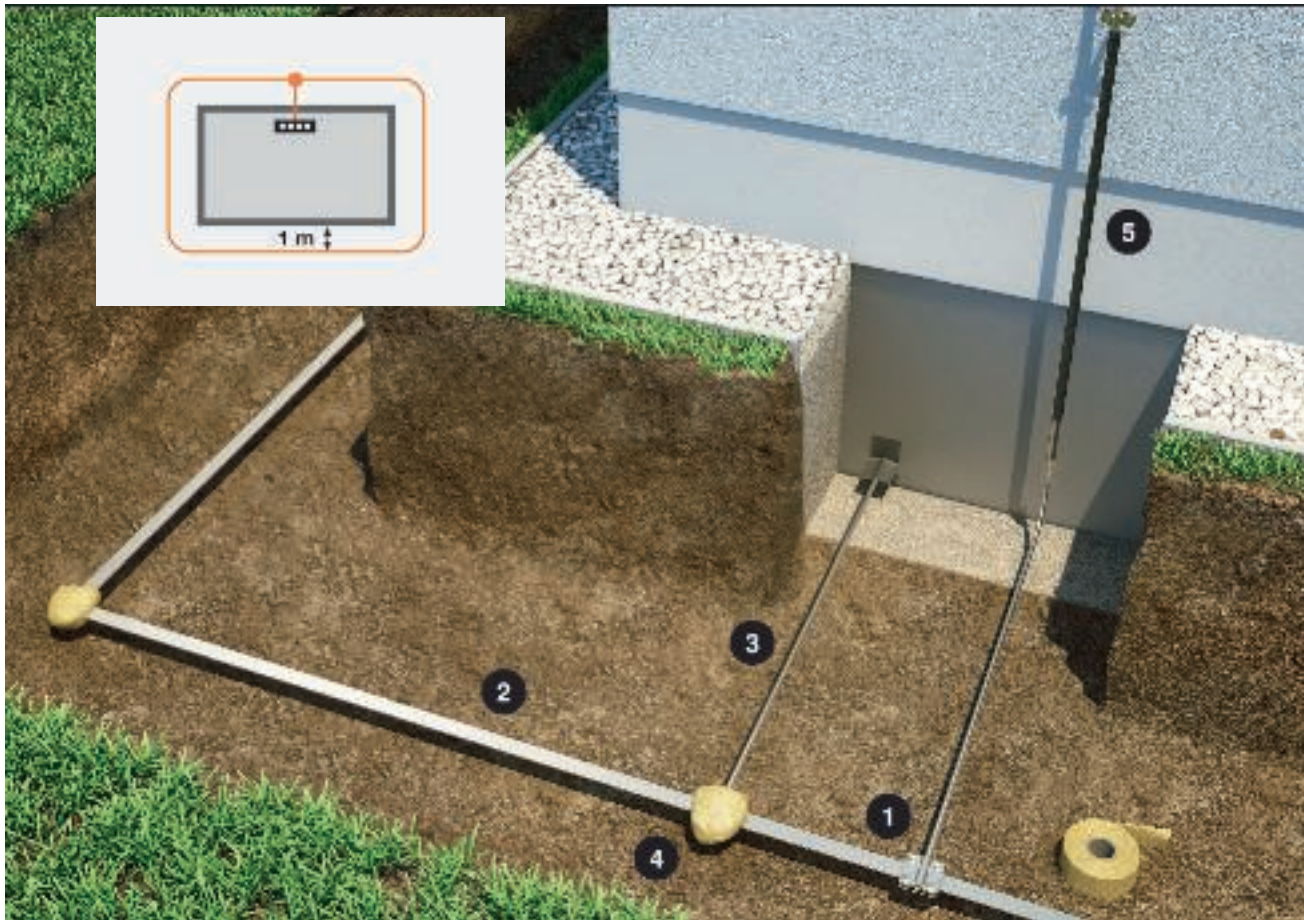

1 = Cross-connectors, 2 = Flat conductors, 3 = Round conductors, 4 = Corrosion protection strip, 5 = Earth entry rod

### Function

Outside the building, at least 80% of the ring earther's (surface earther) overall length must be in contact with the ground. It must be installed as a closed ring at a distance of 1.0 m and a depth of 0.5 m around the external foundation of the building. A ring earther is an earther according to arrangement type B.

### Materials

The following materials can be used:

- Flat conductors made of galvanised steel 30 x 3.5 mm
- Flat conductors made of stainless steel 30 x 3.5 mm
- Round conductors made of copper, Ø 8 mm
- Round conductors made of galvanised steel, Ø 10 mm
- Round conductors made of stainless steel, Ø 10 mm

### Corrosion protection

In potentially corrosive areas, stainless steel (V4A) must always be used. Detachable connections in the ground must be protected against corrosion (plastic corrosion protection strip).







## Selection aid, ring earthers for lightning protection measures

Ring earther				
Application	Designation	Type	Item no.	Product figure
Ring earther for lightning protection measures according to VDE 0185-305-3 Not suitable for loamy or wet soil!	Flat conductor, galvanised steel, 30 m	5052 DIN 30X3.5	<b>5019 34 5</b> Page: 310	
	Flat conductor, galvanised steel, 60 m	5052 DIN 30X3.5	<b>5019 34 7</b> Page: 310	
	Round cable, galvanised steel, 80 m	RD 10	<b>5021 10 3</b> Page: 310	
	Cross-connector for flat conductors and round cables, galvanised steel	252 8-10 FT	<b>5312 31 0</b> Page: 320	
	Cross-connector for flat conductor, galvanised steel	256 A-DIN 30 FT	<b>5314 65 8</b> Page: 319	
Ring earther for lightning protection measures according to VDE 0185-305-3 Usable universally in many environments.	Flat conductor, stainless steel V4A, 25 m	5052 V4A 30X3.5	<b>5018 73 0</b> Page: 310	
	Flat conductor, stainless steel V4A, 50 m	5052 V4A 30X3.5	<b>5018 70 6</b> Page: 310	
	V4A stainless steel round cable, 50 m	RD 10-V4A	<b>5021 64 2</b> Page: 311	
	V4A stainless steel round cable, 80 m	RD 10-V4A	<b>5021 64 7</b> Page: 311	
	Cross-connector for flat conductors and round cables, V4A	252 8-10 V4A	<b>5312 31 8</b> Page: 320	
	Cross-connector for flat conductor, V4A	256 A-DIN 30 V4A	<b>5314 65 9</b> Page: 319	
	Plastic corrosion protection strip, 10 m	356 50	<b>2360 05 5</b> Page: 326	





# Selection aid, ring earthers for protection measures against electric shocks

Ring earther				
Application	Designation	Type	Item no.	Product figure
Ring earthers for protection measures against electric shocks according to DIN 18014	Flat conductor, stainless steel V4A, 25 m	5052 V4A 30X3.5	<b>5018 73 0</b> Page: 310	
	Flat conductor, stainless steel V4A, 50 m	5052 V4A 30X3.5	<b>5018 70 6</b> Page: 310	
	V4A stainless steel round cable, 50 m	RD 10-V4A	<b>5021 64 2</b> Page: 311	
	V4A stainless steel round cable, 80 m	RD 10-V4A	<b>5021 64 7</b> Page: 311	
	Cross-connector for flat conductors and round cables, V4A	252 8-10 V4A	<b>5312 31 8</b> Page: 320	
	Cross-connector for flat conductor, V4A	256 A-DIN 30 V4A	<b>5314 65 9</b> Page: 319	
	Plastic corrosion protection strip, 10 m	356 50	<b>2360 05 5</b> Page: 326	



## Installation principle, foundation earther

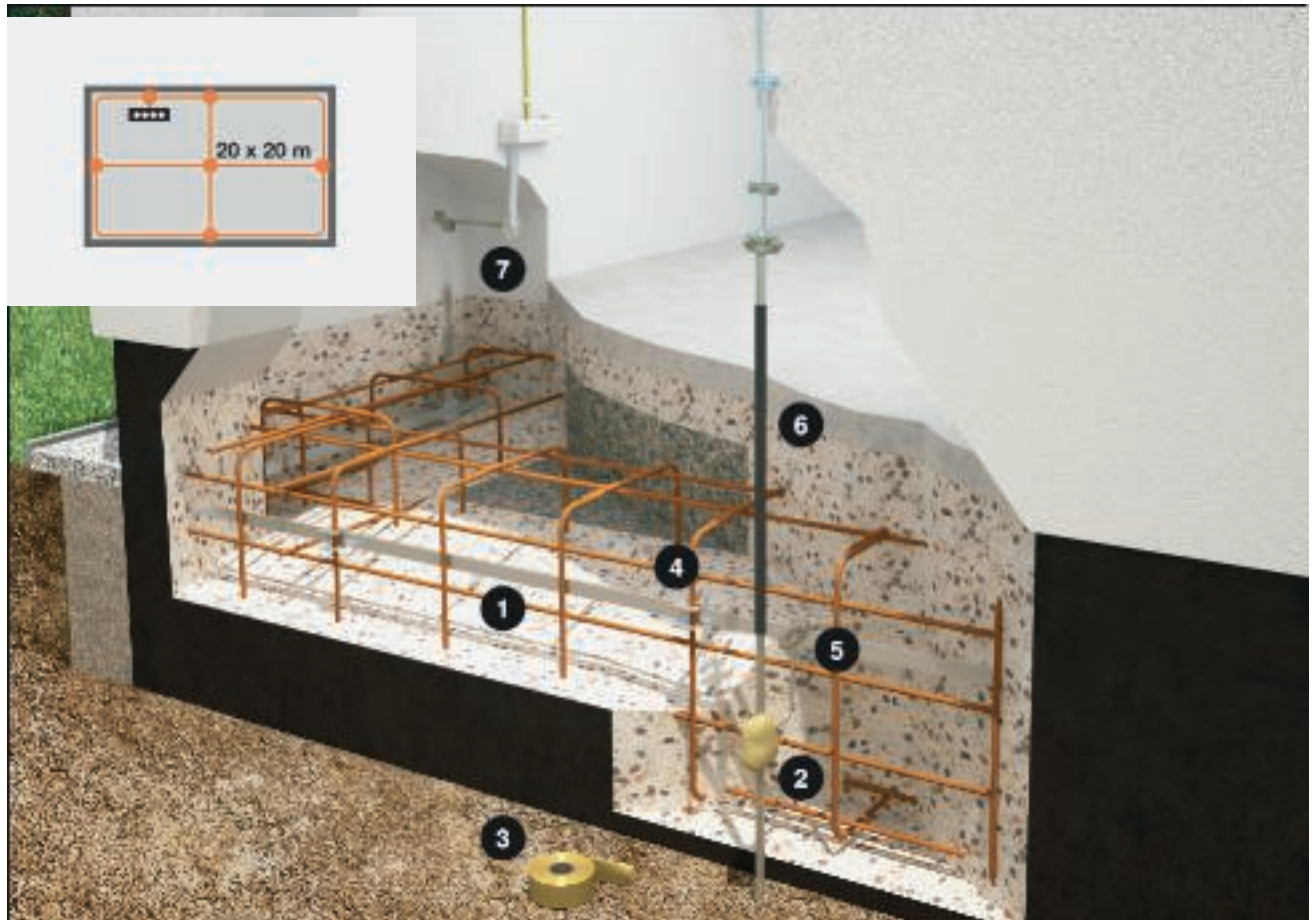

1 = Flat conductor, 2 = Cross-connector with corrosion protection, 3 = Corrosion protection strip, 4 = Connection terminals for reinforcing steels, 5 = Cross-connector, 6 = Earth entry rod, 7 = Earthing fixed point

### Function

A foundation earther is an earther that is embedded into the concrete foundation of a building. It acts as a lightning protection earther if the lugs required for connecting the arrestors protrude from the foundation. The steel strip is to be connected to reinforcements at a distance of approx. 3 m. The basis for the installation of the foundation earther is DIN 18104. Wedge connectors may not be used in the earth. In order to achieve a clean insertion, the use of strip holders is recommended for the installation of foundation earthers. The holders must be inserted at a distance of approx. 2 m.









### Materials

The following materials, among others, can be used for foundation earthers:

- Flat conductors made of galvanised steel 30 x 3.5 mm
- Flat conductors made of stainless steel 30 x 3.5 mm
- Round conductors made of copper, Ø 8 mm
- Round conductors made of galvanised steel, Ø 10 mm
- Round conductors made of stainless steel, Ø 10 mm

Connection lugs must be made of materials with permanent corrosion protection. Hot galvanised steels with plastic jacketing or rust-proof stainless steels of V4A with material number 1.4571 must be used.

## Selection aid, foundation earthers

Foundation earthers				
Application	Designation	Type	Item no.	Product figure
Foundation earthers for lightning protection measures according to VDE 0185-305-3 and for protection measures against electric shocks according to DIN 18014	Flat conductor, galvanised steel, 30 m	5052 DIN 30X3.5	<b>5019 34 5</b> Page: 310	
	Round cable, galvanised steel, 80 m	RD 10	<b>5021 10 3</b> Page: 310	
	Spacer, 250 mm long, galvanised steel	1 81 1	<b>5014 01 8</b> Page: 323	
	Spacer, 400 mm long, galvanised steel	1811 I	<b>5014 02 6</b> Page: 323	
	Cross-connector for flat conductors and round cables, galvanised steel	25 0	<b>5312 90 6</b> Page: 321	
	Cross-connector for flat conductor, galvanised steel	256 A-DIN 30 FT	<b>5314 65 8</b> Page: 319	
	Parallel clamp, galvanised steel	259 A FT	<b>5315 51 4</b> Page: 322	
	Connection terminal for reinforcing steels, galvanised steel	1814 FT	<b>5014 46 8</b> Page: 322	
	Round cable, galvanised steel with PVC jacketing, 75 m	RD 10-PVC	<b>5021 16 2</b> Page: 310	

# Decision-making aid to determine the grid width of ring or foundation earthers

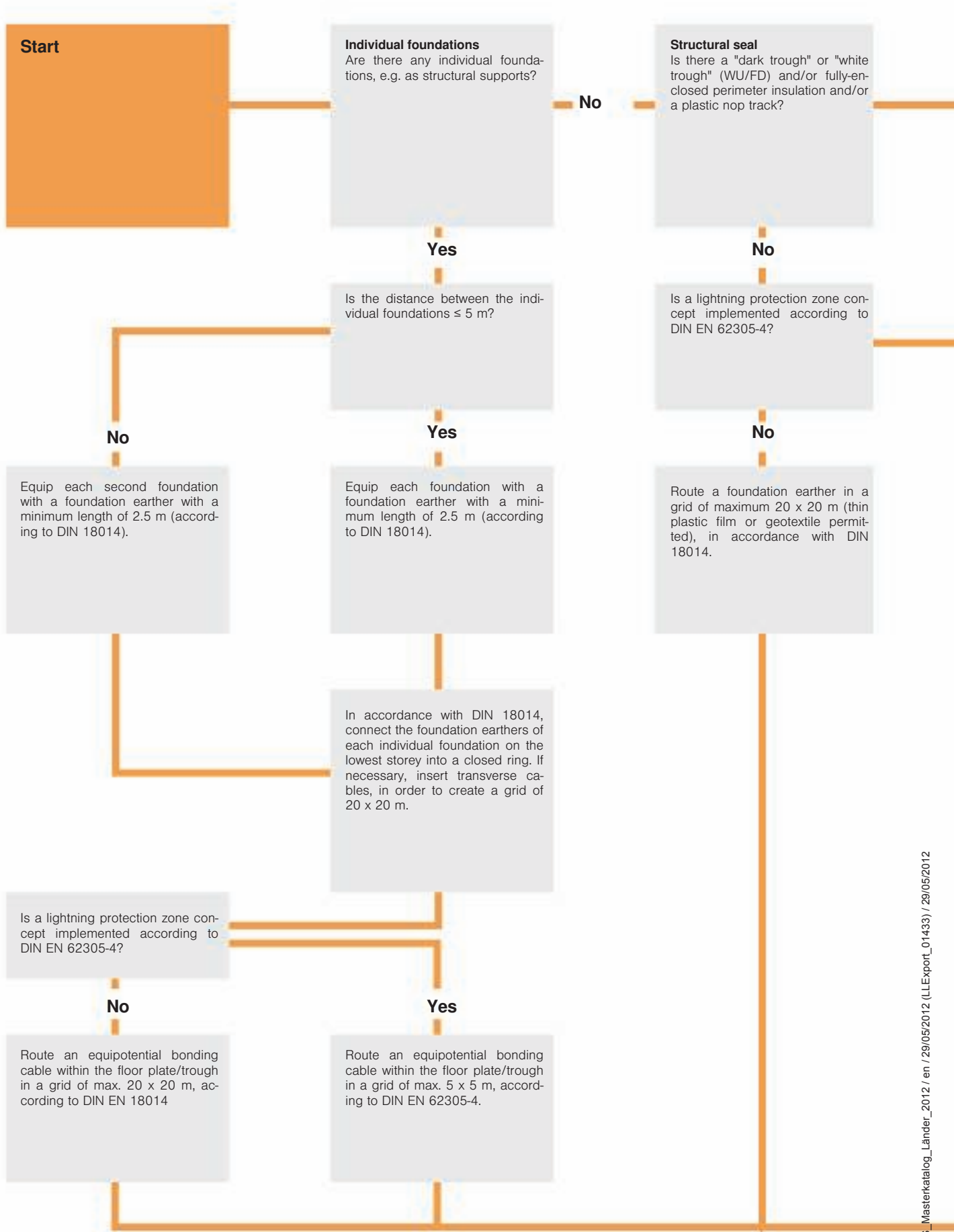

*This decision-making aid is intended for first estimate of typical applications. In every case, please check which actual standards are to be observed in your particular project.*

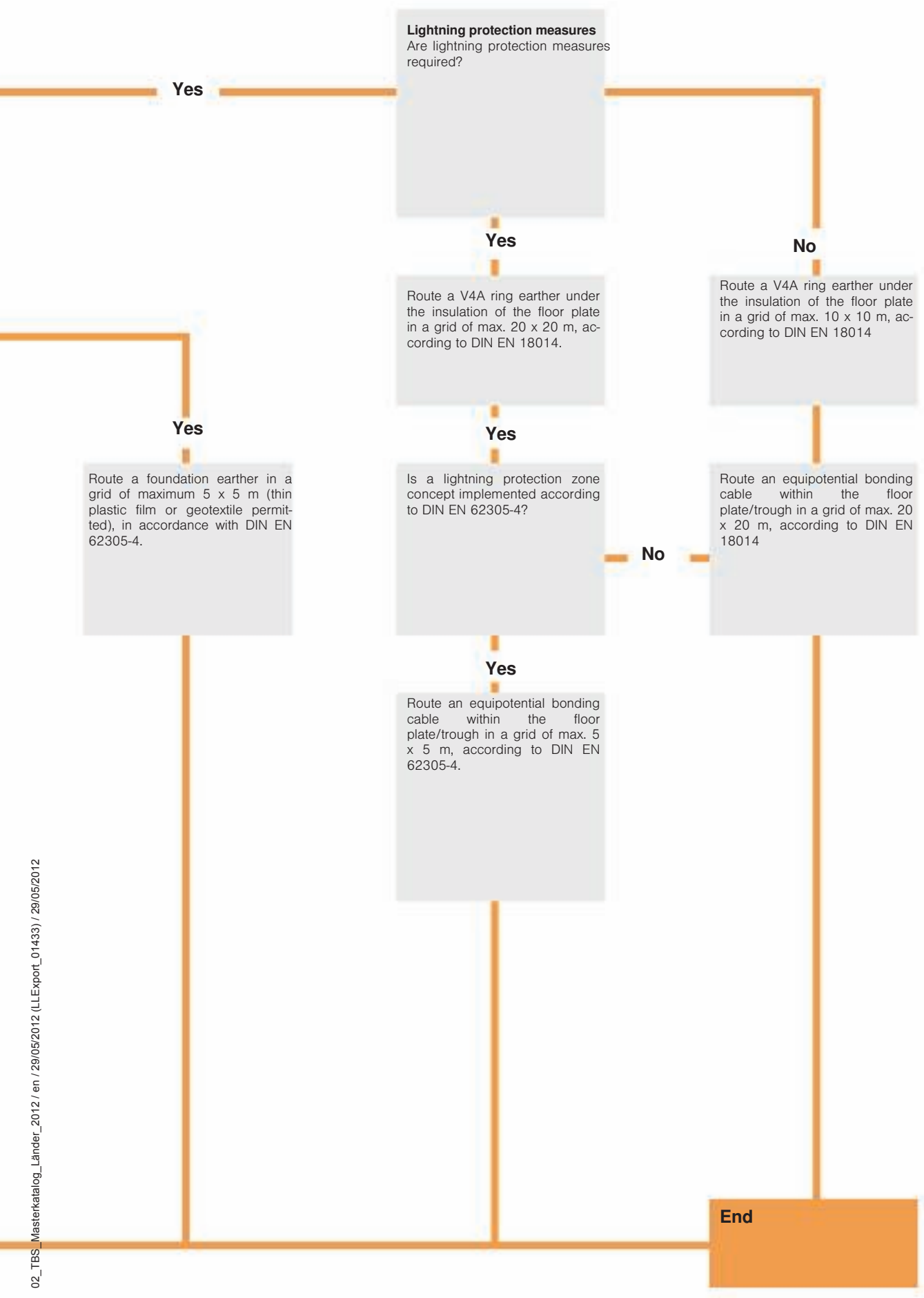



## Planning aids, interception and arrestor systems



Standards for general lightning protection	88
Lightning protection classes	90
Materials for external lightning protection	91
Testing of lightning protection systems	92
Component testing/testing classes	93
Separating distance	94
Installation principle, building with pitched roof	96
Installation principle, building with flat roof	100
Installation principle, building with roof structures	104
Planning aid, protective angle method	106
Planning aid, rolling sphere method	107
Determining the wind load	108
Installation principle, arrestor unit	110

## Standards for general lightning protection



You must take various standards into account when erecting lightning protection systems. You can find the most important European regulations here.

Standard	Contents
<b>DIN VDE 0100-410 (IEC 60364-4-41)</b>	Low-voltage electrical installations Part 4-41: Protection for safety – Protection against electric shock
<b>DIN VDE 0100-443</b>	Low-voltage electrical installations – Part 4-44: Protection for safety – Protection against voltage disturbances and electromagnetic disturbances – Clause 443: Protection against surge voltages of atmospheric origin or due to switching
<b>DIN 18014</b>	Foundation earthers







### Classification of standard series, lightning protection system components VDE 0185-561-... (DIN EN 62561-...)

<b>Section 1</b>	Requirements for connection components
<b>Section 2</b>	Requirements for cables and earthers
<b>Section 3</b>	Requirements for spark gaps
<b>Section 4</b>	Requirements for cable brackets
<b>Section 5</b>	Requirements for inspection boxes and earther penetrations
<b>Section 6</b>	Requirements for lightning counters
<b>Section 7</b>	Requirements for agents to improve earthing



## Lightning protection classes

### Lightning protection classes and allocation

Before a lightning protection system is planned, the object to be protected must be assigned to one of four lightning protection classes. Efficiency in lightning protection class I is the highest at 99% and in lightning protection class IV the lowest at 84% (see table of hazard parameters). The cost of erecting a lightning protection system (e.g. necessary protection angles, distances from loops, protection profiles, distances from arrestors) is more involved for lightning protection class I systems than for lightning protection class IV systems.

### VdS Directive

The required lightning protection class is determined by assessing the damage risk in accordance with DIN EN 62305-2 (IEC 62305-2), unless specified in regulations. Directive VdS 2010 (risk-oriented lightning and surge protection), published by Gesamtverband der Deutschen Versicherungswirtschaft e. V. (GDV) offers alternative method of determining the lightning protection class.



You can obtain further information from [www.vds.de](http://www.vds.de), via OBO Customer Service +49 02373 89-1500 or at [www.obo.de](http://www.obo.de).

### Hazard parameters in dependence of lightning protection classes

Lightning protection class	Peak lightning current value min.	Peak lightning current value max.	Capture probability
I	3 kA	200 kA	98%
II	5 kA	150 kA	95%
II	10 kA	100 kA	88%
IV	16 kA	100 kA	81%

### Lightning protection classes based on Directive VdS 2010

Application	Lightning protection class
Computer centres, military applications, nuclear power stations	I
Ex-zones in industry and the chemicals sector	II
Photovoltaic systems > 10 kW	III
Museums, schools, hotels with more than 60 beds	III
Hospitals, churches, storage facilities, meeting places accommodating more than 100 to 200 people	III
Administrative buildings, sales points, offices and bank buildings of over 2,000 m <sup>2</sup>	III
Residential buildings with more than 20 apartments, multi-storey buildings over 22 m high	III
Photovoltaics (< 10 KW)	III



# Materials for external lightning protection



### Substances and material

The following materials are preferred for use in external lightning protection systems: hot galvanised steel, rust-proof steel (VA), copper and aluminium.

### Corrosion

A risk of corrosion occurs especially when joining different material types. Therefore, no copper parts may be installed above galvanised surfaces or above aluminium parts as copper particles worn away by rain or other environmental influences can penetrate the galvanised surface. In addition, a galvanic element occurs, which accelerates corrosion of the contact surface.

### Examples

As you can see from the examples, the copper connection on the steel water pipe is corroded and could become detached. If two different materials that are not recommended need to be joined, bi-metal connectors can be used. The example shows the use of bi-metal connectors on a copper gutter to which an aluminium round cable is attached. Points at increased risk of corrosion, such as insertion points into the concrete

or soil, must be corrosion-protected. A suitable coating must be applied as corrosion protection to connection points in the ground. Aluminium must not be placed directly (without a distance) on, in or under plaster, mortar or concrete or in the earth – the potential consequences of doing so are shown in our example. In the "Material combinations" table, possible metal combinations are evaluated with regard to contact corrosion in air.

### Material combinations without increased risk of corrosion

	Steel, galvanised	Aluminium	Copper	Stainless steel	Titanium	Tin
Steel, galvanised	Yes	Yes	No	Yes	Yes	Yes
Aluminium	Yes	Yes	No	Yes	Yes	Yes
Copper	No	No	Yes	Yes	No	Yes
Stainless steel	Yes	Yes	Yes	Yes	Yes	Yes
Titanium	Yes	Yes	No	Yes	Yes	Yes
Tin	Yes	Yes	Yes	Yes	Yes	Yes

## Testing of lightning protection systems



### Scope of tests

Lightning protection systems should, even after the acceptance test, be checked at regular intervals to ensure correct functioning, establish any faults and carry out any necessary repairs. The test involves checking the technical documentation and inspecting and measuring of the lightning protection system.

The testing and servicing activities should be carried out on the basis of the standard and the technical principles of DIN VDE 0185-305 Part 3 (IEC 62305-3). The following points must be observed: The tests also comprise checking the

internal lightning protection system. This includes checking the lightning protection equipotential bonding and the connected lightning and surge arrestors. A test report or test log is used to record the testing and servicing of lightning protection systems and must be updated or recreated at each test/service.

### Testing criteria

- Checking all records and documentation, including compliance with the standards
- General condition of interception and arrestor equipment and all connecting components (no loose connections),

- check volume resistance
- Checking the earthing system and the earthing resistors incl. transitions and connections
- Checking internal lightning protection, incl. surge arrestors and fuses
- General corrosion status
- Reliability of fastening the lines of the LPS and its components
- Documentation of all modifications and upgrades to LPS and modifications to buildings

Note: Critical systems (e.g. Ex systems) must be checked annually.

### Time intervals between repeat tests

Protection class	Visual inspection Year	Comprehensive test Year	Comprehensive test in critical situations Year
I and II	1	2	1
III and IV	2	4	1

Critical situations include structures containing sensitive systems, or office and commercial buildings or places in which a large number of people meet.



## Component testing/testing classes



### Connections (tested lightning protection components)

The function of components for lightning protection systems is tested in accordance with DIN EN 50164-1 "Requirements for connection components". After a conditioning phase lasting 10 days, the components are impacted with

three lightning strikes. The interception unit is tested with  $3 \times I_{imp} 100 \text{ kA (10/350)}$ , meaning test class H. The arrestors, along which the lightning current can split up (at least two arrestors) are tested with  $3 \times I_{imp} 50 \text{ kA (10/350)}$ , meaning test class N.



### Test classes of connecting components

Test class	Tested with	Application
H according to DIN EN 50164-1	$3 \times I_{imp} 100 \text{ kA (10/350)}$	Interception system
N according to DIN EN 50164-1	$3 \times I_{imp} 50 \text{ kA (10/350)}$	Multiple arrestors, along which the lightning current can spread, at least two arrestors



## Separation distance



Correctly observed separation distance (s) between arrestor equipment and camera

All metallic parts of a building and electrically powered equipment and their supply cables must be integrated into the lightning protection system. This measure is required to avoid dangerous sparking between both interception system and arrestor and also the metallic building parts and electrical equipment.

### What is a separation distance?

If there is an adequate distance between the conductor passing from the lightning current and the metallic building parts, the risk of sparking is practically non-existent. This distance is described as the separation distance (s).

### Components with direct connection to lightning protection system

A separation distance does not have to be observed in buildings with cross-connected, reinforced walls and roofs or with cross-connected metal facades and metal roofs. Metallic components with no conductive lead into the building to be protected and whose distance to the conductor of the external lightning protection system is less than one metre, must be connected directly to the lightning protection system. These include, although are not limited to, metallic railings, doors, pipes (with non-flammable and/or explosive content), facade elements, etc.

### Application Example 1

Situation: Metallic structures such as railings, windows, doors, pipes (with non-flammable and/or explosive contents) or facade elements without conductive lead into the building.

Solution: Connect the lightning protection system to the metallic components.

### Application Example 2

Situation: Air-conditioning systems, photovoltaic systems, electrical sensors/actuators or metallic vent pipes with conductive lead into the building.

Solution: Insulation by separation distance.

## Calculate separation distance with formula

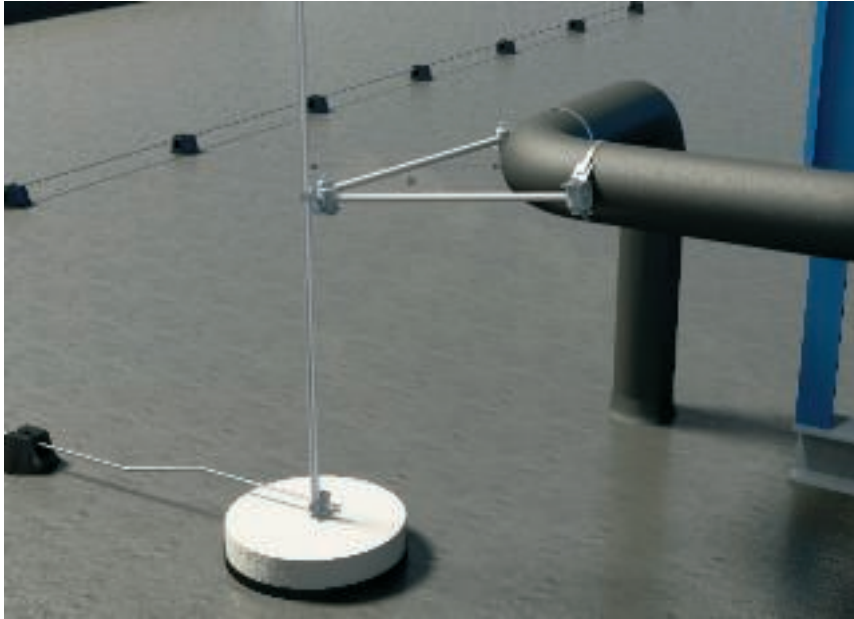

$$s = k_i \frac{k_c}{k_m} L(m)$$

The distance is calculated using this formula.

### Calculation of the separating distance according to VDE 0185-305 (DIN EN 62305-3)

Steps	
Calculate the value of the coefficient $k_i$	$k_i$ is dependent on the selected protection class of the lightning protection system: <ul style="list-style-type: none"> <li>• Protection class I: <math>k_i = 0.08</math></li> <li>• Protection class II: <math>k_i = 0.06</math></li> <li>• Protection classes III and IV: <math>k_i = 0.04</math></li> </ul>
Calculate the value of the coefficient $k_c$ (simplified system)	$k_c$ is dependent on the (partial) lightning current that flows into the arrestors: <ul style="list-style-type: none"> <li>• 1 arrester (only in the case of a separate lightning protection system): <math>k_c = 1</math></li> <li>• 2 arrestors: <math>k_c = 0.66</math></li> <li>• 3 arrestors and more: <math>k_c = 0.44</math></li> </ul> <p>The values apply to all type B earthers and to those type A earthers in which the earther resistance of the neighbouring earther electrodes does not differ by more than a factor of 2. If the earther resistance of individual electrodes deviates by more than a factor of 2, <math>k_c = 1</math> should be assumed.</p>
Calculate the value of the coefficient $k_m$	$k_m$ is dependent on the material of the electrical insulation: <ul style="list-style-type: none"> <li>• Material air: <math>k_m = 1</math></li> <li>• Material concrete, brickwork: <math>k_m = 0.5</math></li> <li>• OBO GFK insulating rods: <math>k_m = 0.7</math></li> </ul> <p>In practice, if multiple insulation materials are used, the lowest value for <math>k_m</math> is used.</p>
Calculate the value L	L is the vertical distance from the point at which the separating distance s is to be calculated up to the closest point of the equipotential bonding.
An example:	<p>Initial situation:</p> <ul style="list-style-type: none"> <li>• Lightning protection class III</li> <li>• Building with more than 4 arrestors</li> <li>• Material: Concrete, brickwork</li> <li>• High point to which the separating distance should be calculated: 10 m</li> </ul> <p>Values according to table:</p> <ul style="list-style-type: none"> <li>• <math>k_i = 0.04</math></li> <li>• <math>k_c = 0.44</math></li> <li>• <math>k_m = 0.5</math></li> <li>• <math>L = 10</math> m</li> </ul> <p>Calculation of separating distance:</p> $s = k_i \times k_c / k_m \times L = 0.04 \times 0.44 / 0.5 \times 10 \text{ m} = 0.35 \text{ m}$



## Installation principle for building with pitched roof







### System components

1	Roof cable holder for ridge riles
2	Vario quick connector
3	Roof cable holder
4	Round cable
5	Interception rod
6	Cable bracket
7	Gutter clamp



## Installation principle for building with pitched roof

### 1st step. Determine the height of the building

Determine the ridge height of the building (see diagram:  $h$ ). This height is the starting point for planning the entire lightning protection system. The ridge conductor is arranged on the ridge and thus forms the "backbone" for the interception system. In our example, the building is 9 m high.

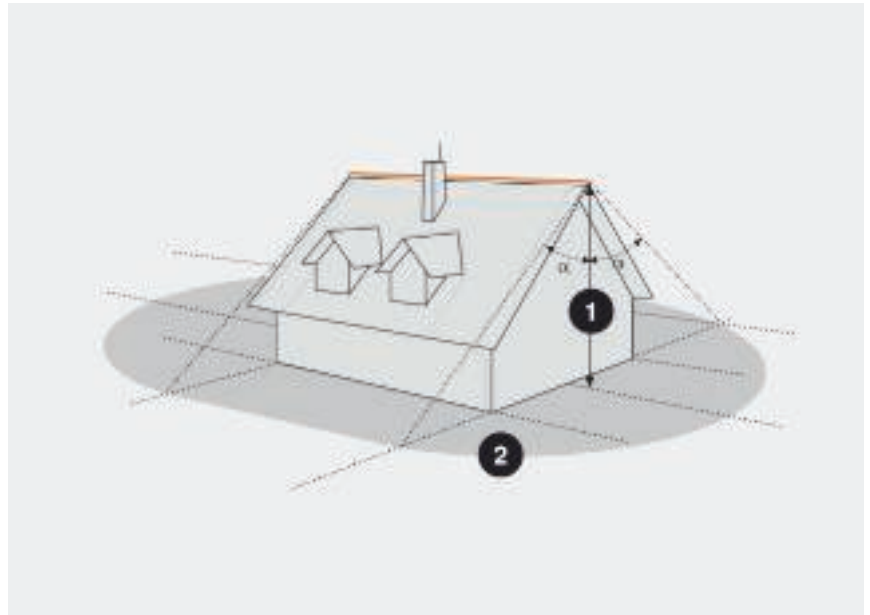

1 = Building height  $h$ , 2 = Protected area,  $\alpha^\circ$  = Lightning protection angle

### 2nd step: Determine the protective angle $\alpha$

The height of the building (in this case: 9 m) is entered onto the horizontal axis on the diagram (see graphic opposite). Then proceed vertically until you meet the curve for your lightning protection class (in this case: III). You can now read the protective angle from the vertical axis  $\alpha$ . In our example, the angle is  $62^\circ$ . Transfer the protective angle to the building. All building parts within this angle are protected (see diagram opposite).

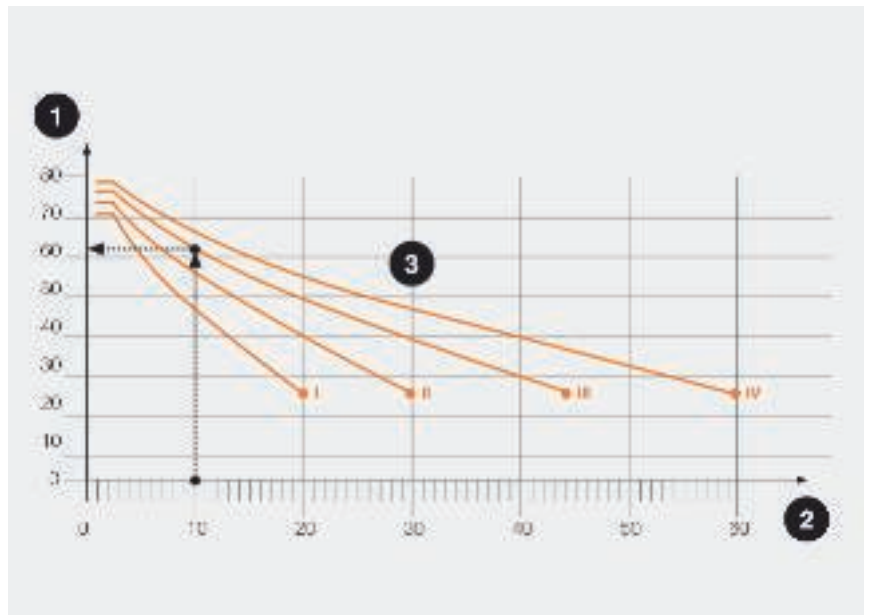

1 = Lightning protection angle  $\alpha^\circ$ , 2 = Ridge height  $h$  in m, 3 = Lightning protection classes I/II/III/IV



## Installation principle for building with pitched roof

### 3rd step: Building parts outside of the protective angle

Building parts outside of the protective angle must be protected separately. The chimney in our example has a diameter of 70 cm and therefore requires a 1.50 m long interception rod. In each case, observe the length diagonals, as described on the following pages. Dormer windows have their own ridge conductor.

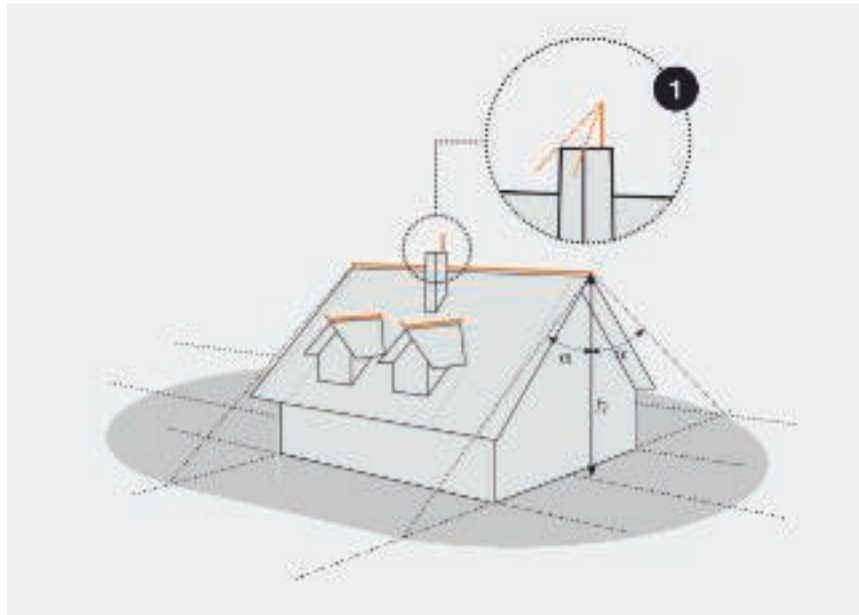

1 = Observe diagonals

### 4th step: Completing the interception system

Take the interception system down to the arrestor equipment. The ends of the ridge conductor should protrude and curve upwards by 0.15 m. This also protects any projecting canopies.

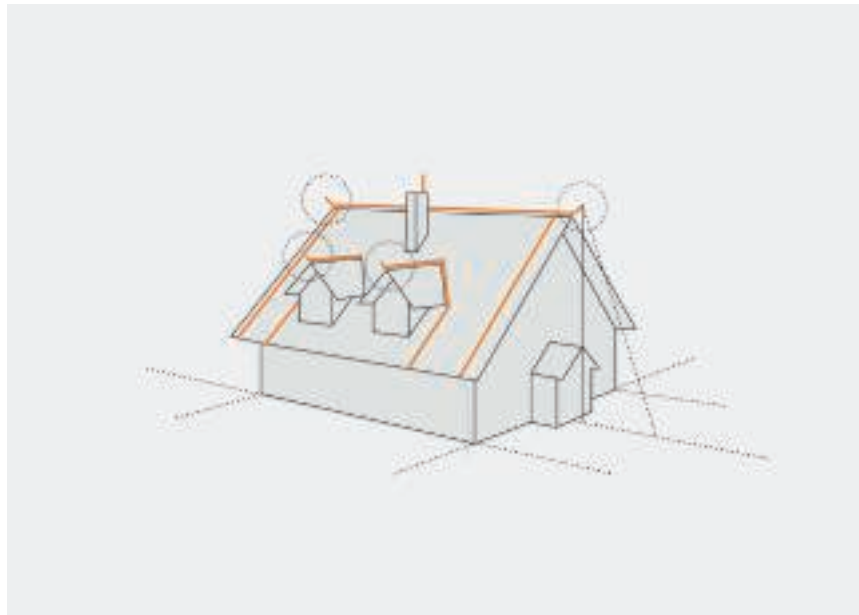

## Installation principle for building with flat roof

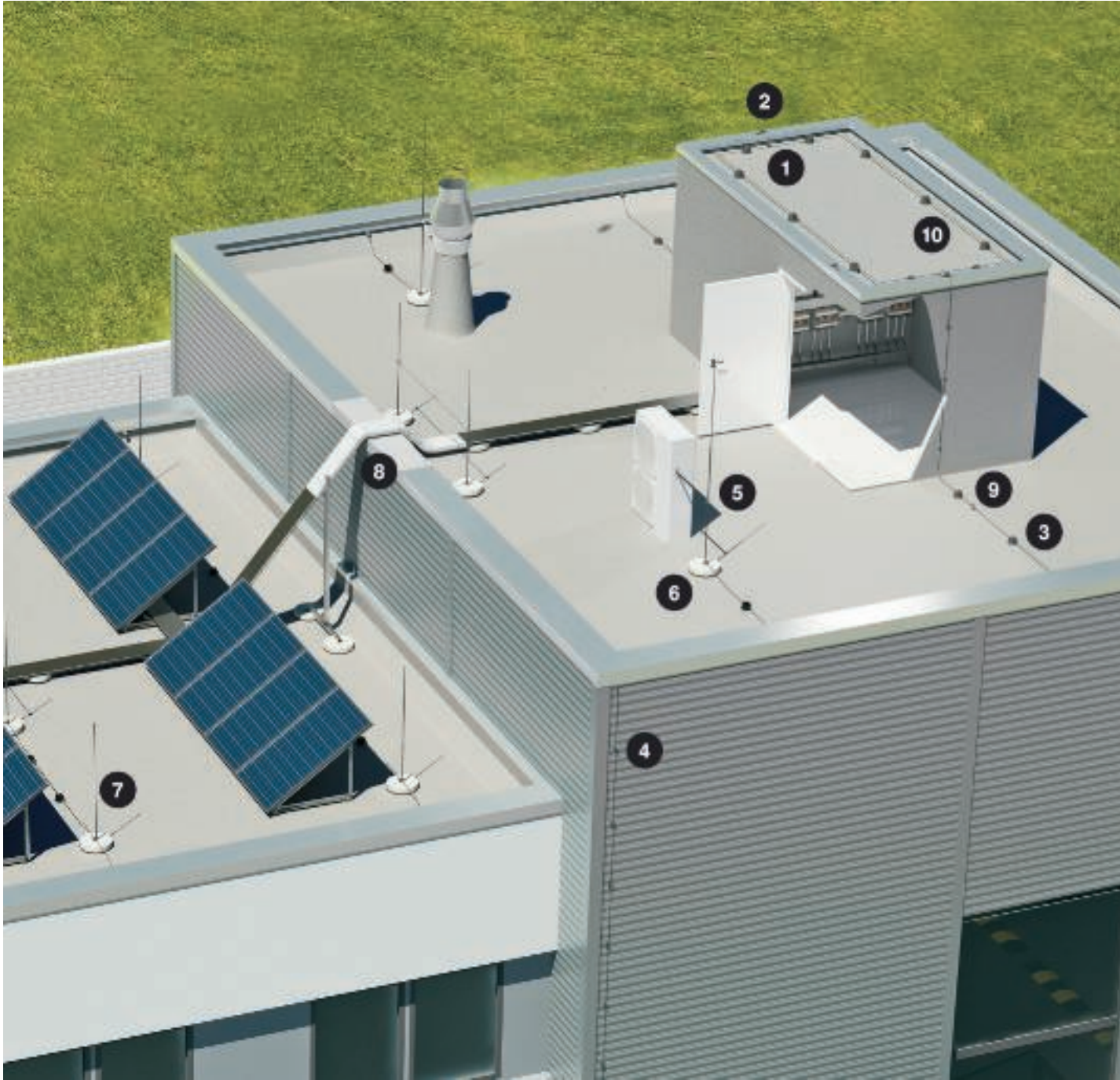

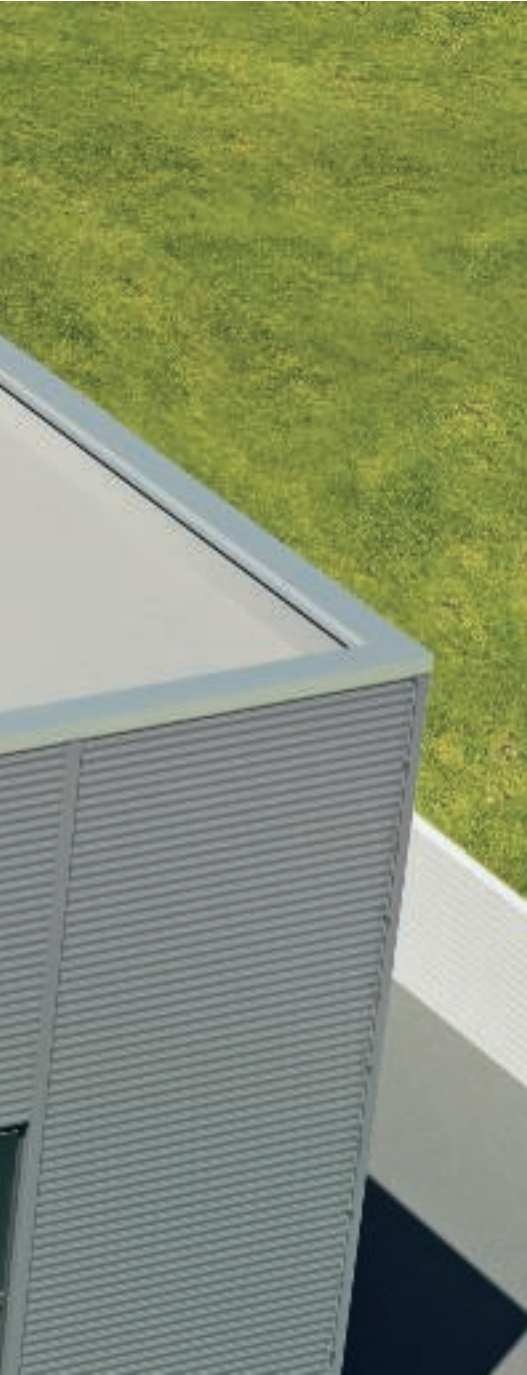

### System components

1	Terminal blocks
2	Bridging components
3	Roof cable holder
4	Cable bracket
5	Insulated spacer
6	Stands, interception system
7	Interception rods
8	Fire protection bandage
9	Expansion piece
10	Vario quick connector



## Installation principle for building with flat roof

### 1st step: Installing the interception system – Part 1

First, a round cable is installed at all primary impact points such as ridges, crests or edges. The protected area is determined as follows:

Transfer the height of the building to the diagram and read off the protective angle. In our example, this angle is  $62^\circ$  with protection class III and a building height up to 10 m. Apply the protection angle to the building. All building parts within this angle are protected.

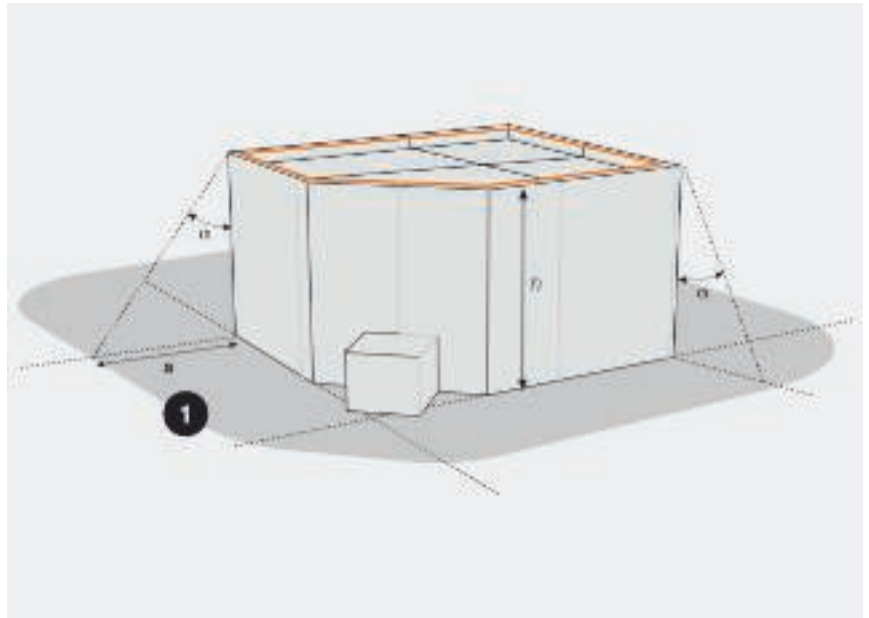

1 = Protected area

### 2nd step: Determine the protective angle $\alpha$

The height of the building (in this case: 9 m) is entered onto the horizontal axis on the diagram (see graphic opposite). Then proceed vertically until you meet the curve for your lightning protection class (in this case: III). You can now read the protective angle from the vertical axis  $\alpha$ . In our example, the angle is  $62^\circ$ . Transfer the protective angle to the building. All building parts within this angle are protected (see diagram opposite).

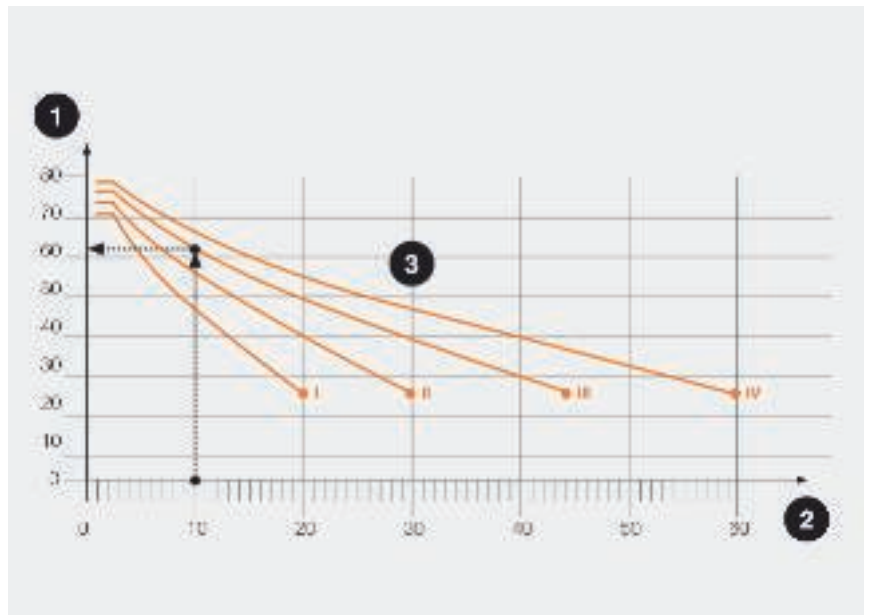

1 = Lightning protection angle  $\alpha^\circ$ , 2 = Ridge height  $h$  in m, 3 = Lightning protection classes I/II/III/IV



## Installation principle for building with flat roof

### 3rd step: Installing the loops

A number of different loop sizes are suitable for the particular lightning protection class of the building. The building in our example has building lightning protection class III. A loop size of 15 m x 15 m must therefore not be exceeded. If, as in our example, the overall length  $l$  is greater than 20 m, an expansion piece must also be integrated for temperature-controlled length changes.

### Loop size by lightning protection class

- Class I = 5 x 5 m
- Class II = 10 x 10 m
- Class III = 15 x 15 m
- Class IV = 20 x 20 m

### 4th step: Protection against lateral impact

From a building height of 60 m and the risk of serious damage (e.g. with electrical or electronic devices) it is advisable to install a ring circuit to protect against lateral impact. The ring is installed at 80% of the building's overall height, the loop size depends – as it does in the case of roof installation – on the lightning protection class, e.g. lightning protection class corresponds to a loop size of 15 x 15 m.

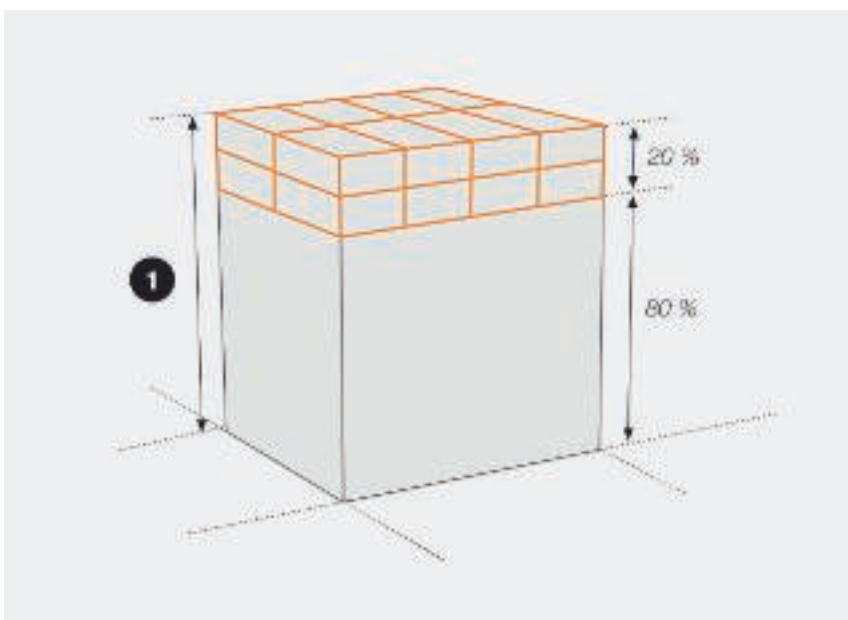
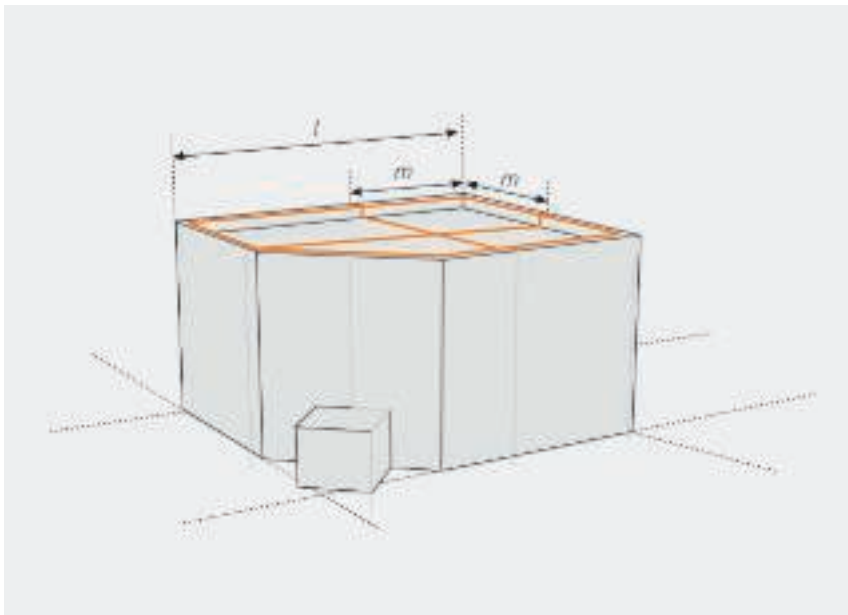

1 = Building height > 60 m



## Installation principle for building with roof structures

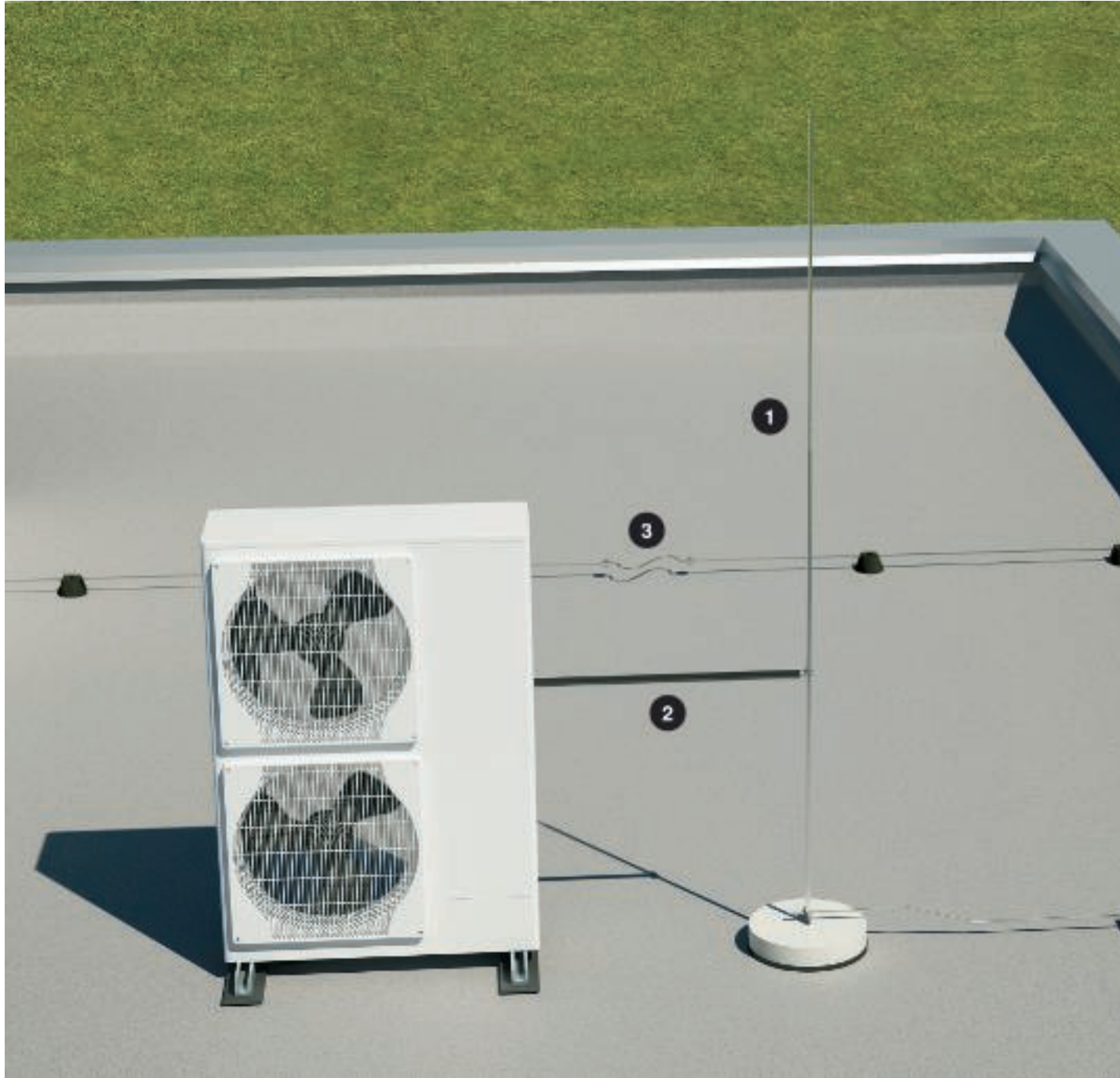





### System components

1	Interception rod
2	Insulated spacer
3	Expansion piece
4	Connection component
5	Roof cable holder



## Planning aid, protective angle method

### Protective angle method for roof structures

You have protected the flat-roofed building correctly according to the standard VDE 0185-305 (IEC 62305). You must now protect all roof structures with interception rods. This involves observing the separating distance (s).

If the roof structure has a conductive continuation into the building (e.g. with a stainless steel pipe with a connection to the ventilation or air conditioning system), then the separating distance (s) must always be maintained. The interception rod must be erected at a certain distance from the building to be protected. This distance safely prevents arcing of the lightning current and dangerous spark creation.



$\alpha^\circ$  = lightning protection angle, s = separating distance

### Roof structures with an individual air-termination rod

The protective angle for lightning rods varies according to lightning protection class.

You can find the protective angle  $\alpha$  in the table for the most common interception rods of up to 2 m in length.

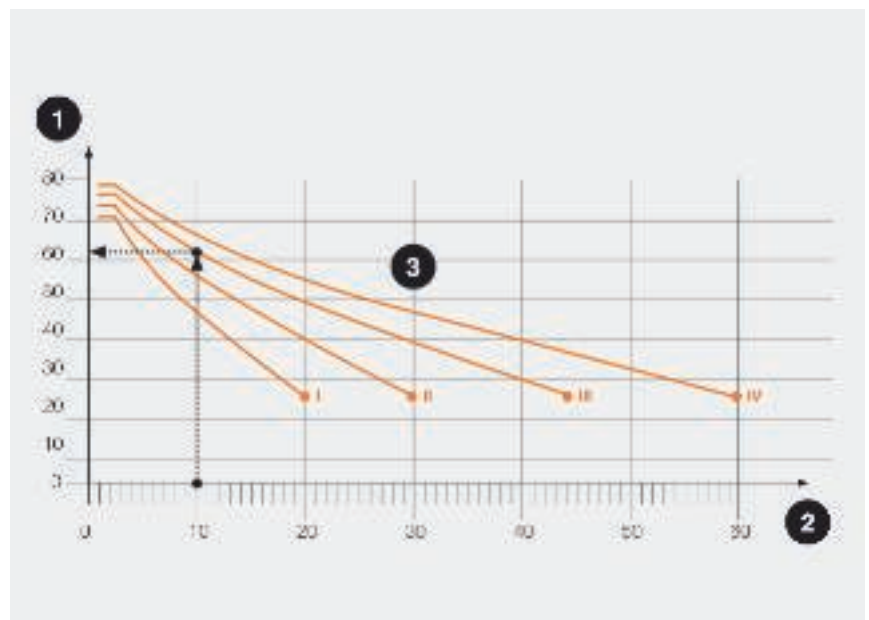

1 = Lightning protection angle  $\alpha^\circ$ , 2 = Ridge height h in m, 3 = Lightning protection classes I/II/III/IV

### Protective angle according to lightning protection class according to VDE 0185-305-3 (DIN EN 62305-3)

Lightning protection class	Protection angle $\alpha$ for interception rods to 2 m length
I	70°
II	72°
III	76°
IV	79°



## Planning aid, rolling sphere method



$$p = R - \sqrt{R^2 - \left(\frac{d}{2}\right)^2}$$

$p$  = penetration depth,  $R$  = radius of the lightning sphere,  $d$  = distance of the interception system

Formula for calculating the penetration depth ( $p$ )

### Roof structures with multiple interception rods

If you use several interception rods to protect an object, you must take into consideration the penetration depth between them. For a precise calculation, use the following formula:

### Penetration depth according to the lightning protection class according to VDE 0185-305

Distance of interception system ( $d$ ) in m	Penetration depth lightning protection class I lightning protection sphere: $R = 20$ m	Penetration depth lightning protection class II lightning protection sphere: $R = 30$ m	Penetration depth lightning protection class III lightning protection sphere: $R = 45$ m	Penetration depth lightning protection class IV lightning protection sphere: $R = 60$ m
2	0.03	0.02	0.01	0.01
3	0.06	0.04	0.03	0.02
4	0.10	0.07	0.04	0.04
5	0.16	0.10	0.07	0.05
10	0.64	0.42	0.28	0.21
15	1.46	0.96	0.63	0.47
20	2.68	1.72	1.13	0.84

## Determining the wind load



Wind load zones in Germany according to DIN 1055-4

### 3rd step: Determining the wind load

Use the table to determine how many stones you need to securely install the interception rod. The values in this table relate to fastening tapered interception rods in the 101/V OBO range using the FangFix system.



### Maximum wind speeds according to DIN 1055-4

Zone	Wind speed in km/h
1	127
2	145
3	162
4	185





### FangFix blocks according to wind zones and interception rod height

	<b>Zone 1: Areas with relief heights of up to 600 m above sea level</b>	<b>Zone 2: North German plains</b>	<b>Zone 3: North and Baltic Sea coast</b>	<b>Zone 4: Islands in German bays</b>
Interception rod height 1.5 m	1 x 10	1 x 10	1 x 16	1 x 16
Interception rod height 2 m	1 x 16	1 x 16	1 x 16 and 1 x 10	1 x 16 and 1 x 10
Interception rod height 2.5 m	1 x 16	1 x 16 and 1 x 10	2 x 16	2 x 16 and 1 x 10
Interception rod height 3 m	2 x 16	2 x 16	2 x 16 and 1 x 10	on request
Interception rod height 3.5 m	2 x 16	3 x 16	on request	on request
Interception rod height 4 m	2 x 16 and 1 x 10	3 x 16 and 1 x 10	on request	on request

## Installation principle, arrestor unit



### Number of arrestors

The arrestor system routes the lightning current from interception system to earthing system. The number of arrestors is derived from the scope of the building to be protected although at least two arrestors are required in every case. Care must be taken to ensure that the current paths are short and installed without loops. The table shows the distances between the arrestors and the corresponding lightning protection classes.

### Arrangement of the arrestors

The arrestors should preferably be installed near the corners of the building. In order to achieve optimum splitting of the lightning current, the arrestors must be evenly distributed around the outer walls of the building.



### System components

1	Roof gutter clamp
2	Cable bracket
3	PCS magnetic card
4	Number plate
5	Separating piece
6	Earth entry rod

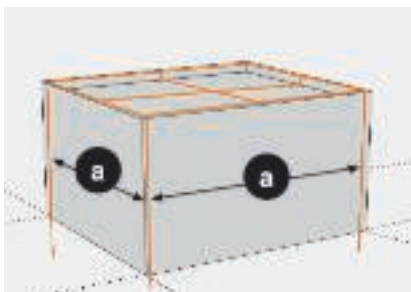

### Assigning the lightning protection classes by distances

Lightning protection class	Distance between the arrestors a
I	10 m
II	10 m
III	15 m
IV	20 m







## Planning aids, insulated lightning protection



Insulated lightning protection	114
Insulation lightning protection - sets	116
isFang interception rod system	118
Selection aid, isFang system	119
OBO isCon® system	120
Interception and arrestor system	122
Application examples	123
Insulated interception rod	124
Ex areas	125

## Insulated lightning protection



Insulated intercepting device with separating spacing (s)

The complex contours of metallic and electrical units protruding above the roof make particular demands of lightning protection and compliance with the separating distance.

### Creating a separating distance

With the OBO insulated lightning protection, you can erect separate interception devices safely, economically and in accordance with standards. The core of the system is an insulating, fibre glass-reinforced plastic rod, which creates the separating distance safely and prevents uncontrolled arcing and dangerous spark creation. This means that no partial lightning currents can enter the building.





Interception rod with Iso-combination set and separating distance (s)

### Two material thicknesses for different applications

The insulated lightning protection system consists of GFK rods with a diameter of 16 or 20 mm with the following properties:

#### 16 mm GFK rods

- Up to 3 m length
- UV-stable
- Light grey
- Material factor km: 0.7
- Load torque: > 400 mm<sup>3</sup>
- Support load: 54 N (1.5 m)

#### 20 mm GFK rods

- Up to 3 m length
- UV-stable
- Light grey
- Material factor km: 0.7
- Load torque: > 750 mm<sup>3</sup>
- Support load: 105 N (1.5 m)

There is a comprehensive range of system accessories available for both variants.

### Particularly simple mounting through pre-terminated sets

Besides the modular products, we can offer you pre-installed sets for standard installation requirements:

- Set with two fastening plates
- Set with wall connection brackets
- Set for fastening on folds
- Set for fastening on pipes



## Insulation lightning protection - sets

### 3-corner fastening

Iso-combination set for 3-corner fastening for the erection of an insulated interception system at a safe separating distance (s). For mounting on walls and roof structures with two fastening plates. To accept interception rods and round cables of 8, 16 and 20 mm diameter.

- Type: 101 3-ES-16
- Article No. 5408976
- L = 750 mm
- H = 1,500 mm



### V fastening

Iso-combination set for fold fastening for the erection of an insulated interception system at a safe separating distance (s) of up to 750 mm. For mounting on the fold of supports and roof structures with folding clamps with a folding thickness of up to 20 mm. To accept interception rods and round cables of 8, 16 and 20 mm diameter.

- Type: 101 VS-16
- Article No. 5408978
- L = 750 mm





### Fold fastening

Iso-combination set for fold fastening for the erection of an insulated interception system at a safe separating distance (s). For mounting on the fold of supports and roof structures with folding clamps with a folding thickness of up to 20 mm. To accept interception rods and round cables of 8, 16 and 20 mm diameter.

- Type: 101 FS-16
- Article No. 5408980
- L = 750 mm



### Pipe V fastening

Iso-combination set for pipe V fastening for the erection of an insulated interception system at a safe separating distance (s). For mounting on pipes with two pipe clamps. To accept interception rods and round cables of 8, 16 and 20 mm diameter.

- Type: 101 RVS-16
- Article No. 5408982
- L = 750 mm



## isFang interception rod system

### Quickly and simply installed

The OBO isFang modular interception rod system can offer a fast and freely terminable solution for insulated interception rod systems, as well as high interception rods for the largest possible protection angle.

### Insulated variant

The insulated interception rods protect electrical and metallic roof structures, taking the calculated separating distance (s), according to VDE 0185-305-3 (IEC 62305-3), into account. An insulated section of 1.5 metres made of fibre-glass reinforced plastic (GFK) ensures sufficient distance to all roof structures. Even complex building structures can be protected by the comprehensive system accessories.

### Aluminium variant

The 3-part interception rods of between 4 and 8 metres and made of aluminium complement the conventional interception system made of interception rod and block, which is used for heights of up to 4 metres. Various brackets for mounting on walls, pipes and corner pipes, as well as two tripod stands with different spreading widths, are available to fasten the various interception rods.

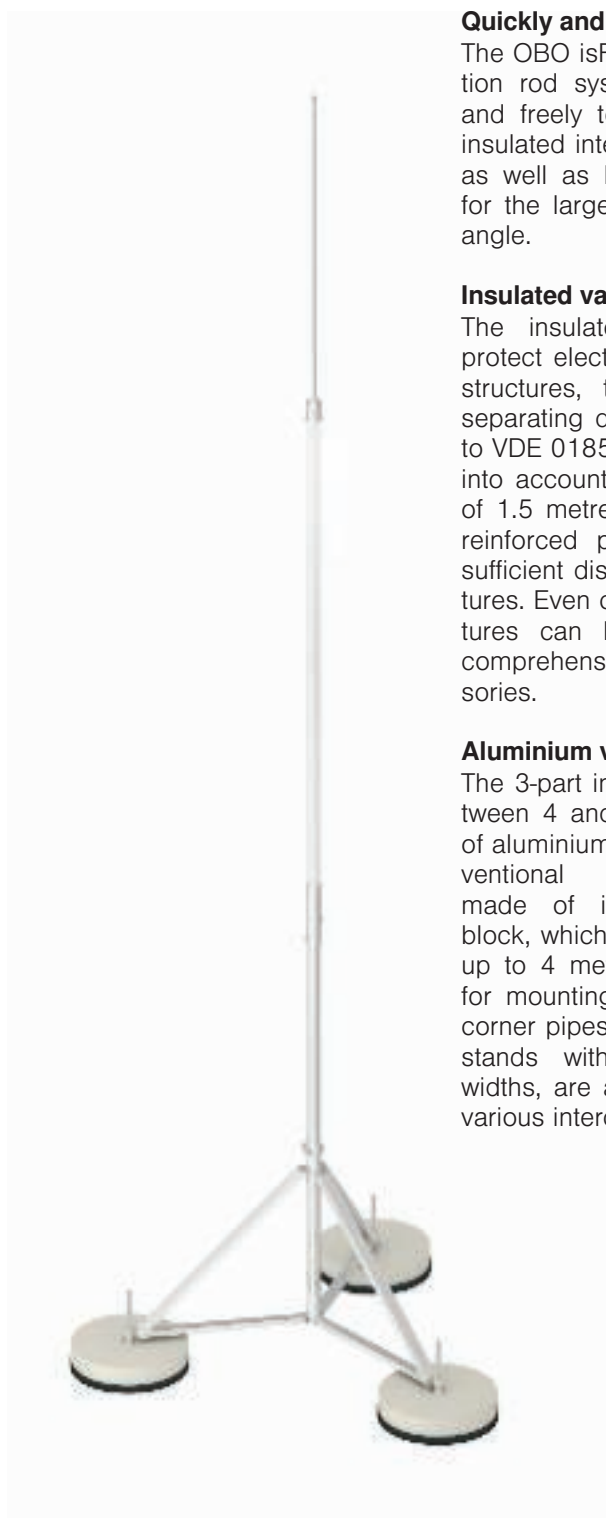

## Selection aid, isFang system



Simple erection of the tripod stand: position the blocks...

... open up the stand...

... and screw to the FangFix concrete blocks.

**Please note that the number of FangFix blocks required may vary according to the wind strength.**

### Arrangement of interception rod system (in wind load zone 1 and 2)

Height of interception rod, aluminium	Spreading width, tripod stand	Amount of FangFix concrete blocks 16 kg	Amount of FangFix edge protection	Length of threaded rod
4 m Item no. 5402864	1 m, ALU, item no. 5408966 1 m, VA, item no. 5408968	3 blocks Item no. 5403227	3 x edge protection Item no. 5403238	270 mm Item no. 5408971
4.5 m Item no. 5402866	1 m, ALU, item no. 5408966 1 m, VA, item no. 5408968	3 blocks Item no. 5403227	3 x edge protection Item no. 5403238	270 mm Item no. 5408971
5 m Item no. 5402868	1 m, ALU, item no. 5408966 1 m, VA, item no. 5408968	6 blocks Item no. 5403227	3 x edge protection Item no. 5403238	340 mm Item no. 5408972
5.5 m Item no. 5402870	1 m, ALU, item no. 5408966 1 m, VA, item no. 5408968	6 blocks Item no. 5403227	3 x edge protection Item no. 5403238	340 mm Item no. 5408972
6 m Item no. 5402872	1.5 m, ALU, item no. 5408967 1.5 m, VA, item no. 5408969	6 blocks Item no. 5403227	3 x edge protection Item no. 5403238	340 mm Item no. 5408972
6.5 m Item no. 5402874	1.5 m, ALU, item no. 5408967 1.5 m, VA, item no. 5408969	6 blocks Item no. 5403227	3 x edge protection Item no. 5403238	340 mm Item no. 5408972
7 m Item no. 5402876	1.5 m, ALU, item no. 5408967 1.5 m, VA, item no. 5408969	9 blocks Item no. 5403227	3 x edge protection Item no. 5403238	430 mm Item no. 5408973
7.5 m Item no. 5402878	1.5 m, ALU, item no. 5408967 1.5 m, VA, item no. 5408969	9 blocks Item no. 5403227	3 x edge protection Item no. 5403238	430 mm Item no. 5408973
8 m Item no. 5402880	1.5 m, ALU, item no. 5408967 1.5 m, VA, item no. 5408969	9 blocks Item no. 5403227	3 x edge protection Item no. 5403238	430 mm Item no. 5408973

### Arrangement of insulated interception rod system (in wind load zone 1 and 2)

Height of insulated interception rod	Spreading width, tripod stand	Amount of FangFix concrete blocks 16 kg	Amount of FangFix edge protection	Length of threaded rod
4 m, GFK/ALU, item no. 5408943 4 m, GFK/VA, item no. 5408942	1 m, ALU, item no. 5408966 1 m, VA, item no. 5408968	3 blocks Item no. 5403227	3 x edge protection Item no. 5403238	270 mm Item no. 5408971
6 m, GFK/ALU, item no. 5408947 6 m, GFK/VA, item no. 5408946	1 m, ALU, item no. 5408966 1 m, VA, item no. 5408968	6 blocks Item no. 5403227	3 x edge protection Item no. 5403238	340 mm Item no. 5408972





In complex installations, the required separating distance can often no longer be implemented with conventional arrestors, as the structural conditions do not permit the required distances between the interception systems and the electrical installations. Insulated lightning protection systems, such as the OBO isCon® cable, are used to maintain the required separating distance.

**Tested: 0.75 m separation distance and up to 150 kA lightning current**

After first potential connection behind the connection element, the isCon® cable reflects an equivalent separation distance of up to 0.75 metres in the air according to VDE 0185-305-3. This means that installation is possible directly on metallic and electrical structures. There is no direct arcing between the arrestor and the building to be protected.

**Total flexibility on the construction site**

The OBO isCon® cable can be used flexibly. The isCon® cable is delivered on disposable cable rolls. This means that the user can cut them to the exact size they require and terminate them as necessary. This means: no ordering of preterminated cables, but rather flexible working according to actual conditions on the construction site. Special knowledge is required to be able carry out the planning and routing of the isCon® correctly. This knowledge is imparted by the current installation instructions, but can also be deepened in special OBO workshops.







### Halogen freedom

Halogen-free cables prevent the creation of corrosive and toxic gases during construction. The gases can cause considerable damage to people and property. The costs resulting from the corrosiveness of the fire gases are often higher than the costs caused by direct fire damage. The OBO isCon® cable is made from halogen-free materials.



### Combustion behaviour

A fire can spread along a non-flame-resistant cable in just a few minutes. Those cables are considered flame-resistant that prevent the spread of fire and which extinguish themselves after the ignition flame is removed. The flame resistance of the OBO isCon® cable was proven according to DIN EN 60332-1-2.



### Weathering resistance

The outer jacket of the OBO isCon® cable is made of a very ageing-resistant material (EVA = ethylene vinyl acetate). The resistance to weathering was confirmed by the following tests:

- Ozone resistance according to DIN EN 60811-2-1 Section 8
- Sunlight Resistance Test according to UL 1581 Section 1200
- Coldness impact resistance according to DIN EN 60811-1-4 Section 8.5



## OBO isCon® system: interception system and arrester



### The interception system

The routing of the interception system is planned taking DIN EN 62305-3 (VDE 0185-305-3) Section 5.2 into account. The area to be protected must be designed specially according to the height and arrangement of the interception system.

### The arrester

Only the connection element may be connected to the interception unit or forwarding arrester of the external lightning protection. The cable must be located in the protection area of the interception system and be fastened at a distance of maximum one metre using the installation material indicated. If cables are routed in the building, then specified protection measures, such as fire insulation, must be taken into account.

### Separation distance

Calculation of the separating distance according to DIN EN 62305-3 (VDE 0185-305-3) Section 6.3 at the point the isCon® cable is connected. The length (l) should be measured from the connection point of the isCon® cable to the next level of the lightning protection equipotential bonding (e.g. earthing system). Check whether the calculated separating distance (s) is less than the specified equivalent separating distance of the isCon® cable. If the specified separating distance is exceeded, then additional arrestors must be installed.

### Maximum lengths of the isCon cable at $s = 0.75$ m

LPS – lightning protection class	Number of arrestors	Length at $s=0.75$ m
I	1	-
	2	12.20
	3 and more	21.30
II	1	12.50
	2	18.94
	3 and more	28.40
III	1	18.75
	2	28.40
	3 and more	42.61

An exact calculation of the separating distance proves the possible use of the isCon cable.

COMMENT: The values in the table apply to all type B earthers and to those type A earthers in which the earth resistance of the neighbouring earther electrodes does not differ by more than a factor of 2. If the earther resistance of individual electrodes deviates by more than a factor of 2,  $k_c = 1$  should be assumed.

Source: Table 12 DIN EN 62305-3:2011



## OBO isCon® system: application examples



### Application example: soft-covered roofs

Soft-covered roofs, for example with straw, thatch or reeds, require increased protection against lightning strikes and the resulting risk of fire.

In order to meet the aesthetic requirements of the client, a lightning protection system using an isCon® cable is recommended. The interception system is implemented using interception rods, which allow the cable to be routed in their interior (type isFang IN). The grey variant of the isCon® cable guarantees a high degree of protection and should be used for soft roofs. In this way, the cable can be routed under the soft roof.

---

**Observe the OBO isCon® system manual for detailed mounting instructions.**



### Application example: mobile telecommunications system

Installations such as mobile telecommunications systems must be included in the lightning protection concept, particularly in the case of refitting work.

Spatial restrictions, as well as the influence of transmission signals, can be overcome by constructing the lightning protection system using an isCon® cable. Simple inclusion in the existing lightning protection system as well as separate lightning protection can be implemented simply and in accordance with the standards.



### Aesthetic aspects

In easily visible areas, as well as wherever aesthetics are important, we recommend routing the isCon® cable in interception rods. Equipotential bonding after the first 1.5 metres takes place in the rod. The entire retaining pipe is earthed, guaranteeing comprehensive equipotential bonding. A simple and visually perfect installation solution.



## OBO isCon® system: insulated interception rod

### Routing the isCon cable in insulated interception rods

Visually attractive and functionally adapted insulated interception rod for flexible, simple and quick installation. The interior isCon® cable means that the interception rod requires only a minimum wall attachment area and can thus also be installed at high and windy points.

The insulated interception rod should be connected to a reference potential using  $\geq 6 \text{ mm}^2$  Cu or an equal conductivity. Lightning current may not flow through the reference potential and it must be in the protection angle of the lightning protection system. This means that the potential connection can be made via metallic and earthed roof structures, generally earthed parts of the building structure and via the protective conduc-



### Arrangement in wind load zone 1 and 2

Interception rod with side exit	Interception rod with bottom exit	Bracket (number and positioning depending of building structure)	Amount of FangFix blocks 16 Kg F-FIX-S16	Amount of FangFix edge protection F-FIX-B16	Length of threaded rod isFang 3B-G...
isFang IN-A 4000 Item no. 5408938		isFang 3B-100-A Item no. 5408930	6 pieces Item no. 5403227	3 pieces Item no. 5403238	3 x 340 mm Item no. 5408972
	isFang IN 4000 Item no. 5408934	isFang TW... isFang TR... isFang TS...			
isFang IN-A 6000 Item no. 5408940		isFang 3B-150-A Item no. 5408932	9 pieces Item no. 5403227	3 pieces Item no. 5403238	3 x 430 mm Item no. 5408973
	isFang IN 6000 Item no. 5408936	isFang TW... isFang TR... isFang TS...			



## OBO isCon® system: Ex areas



### Installation in potentially explosive areas

When planning and running a lightning protection system through Ex zones, the following rules must particularly be taken into account:

- DIN EN 62305-3 – Appendix D – "Additional information for lightning protection systems for structure in areas with the risk of explosion"
- VDE 0185-305-3 – Supplementary sheet 2 – "Additional information for special structures"

For Ex systems with Ex zone 2 and 22, supplementary sheet 2 (VDE 0185-305-3, Point 4.3) states that an Ex atmosphere will only occur in rare, unforeseen circumstances. Therefore, it is possible to position interception units in Ex zone 2 and 22, taking Appendix D in DIN EN 62305-3 (VDE 0185-305-3) into account.

















In the Ex zones 1 and 21, after the first potential connection, the OBO isCon® cable should be connected at regular distances (0.5 metres) using a metallic cable bracket (e.g. isCon H VA or PAE) to the equipotential bonding. If there is a lightning strike, lightning current may not flow through the equipotential bonding and it must be in the protection angle of the lightning protection system.

---

**Secure screw connectors against loosening.**







## Test marks

	Lightning current-tested
	Lightning current-tested, Class H (100 kA)
	ELEKTROTECHNICKÝ ZKUŠEBNÍ ÚSTAV, Czech Republic
	ATEX certificate for explosive areas
	Russia, GOST The State Committee for Standards
	KEMA-KEUR, Netherlands
	Indication of metric products
	MAGYAR ELEKTROTECHNIKAI ELLENŐRZŐ INTÉZET Budapest, Hungary
	Österreichischer Verband für Elektrotechnik, Austria
	Underwriters Laboratories Inc., USA
	Eidgenössisches Starkstrominspektorat, Switzerland
	Underwriters Laboratories Inc., USA
	Verband der Elektrotechnik, Elektronik, Informationstechnik e.V., Germany
	German Association of Electricians, tested safety
	5-year warranty
	Halogen-free; without chlorine, fluorine and bromine









# Pictogram explanation



















## Lightning protection classes

	Protection device to DIN EN 61643-11 or IEC 61643-11
	Combination protection device made of type 1 and type 2
	Protection device to DIN EN 61643-11 or IEC 61643-11
	Protection device to DIN EN 61643-11 or IEC 61643-11
	Protection device to DIN EN 61643-11 or IEC 61643-11

## Lightning protection zone

	Transition from LPZ 0 to LPZ 1
	Transition from LPZ 0 to LPZ 2
	Transition from LPZ 0 to LPZ 3
	Transition from LPZ 1 to LPZ 2
	Transition from LPZ 1 to LPZ 3
	Transition from LPZ 2 to LPZ 3

## Applications

	Remote signalling
	Remote signalling with fuse monitoring
	Acoustic signalling
	Integrated Service Digital Network, ISDN applications
	Digital Subscriber Line, DSL applications
	Analogue telecommunication
	Category 5 TwisterPair
	Channel Performance to American EIA/TIA standard
	Measuring, controlling and regulating systems
	TV applications
	SAT-TV applications
	Multibase base
	LifeControl
	Intrinsically safe protection device for areas with a risk of explosions
	Channel Performance to ISO / IEC 11801
	Power over Ethernet
	230/400 V system
	Metric







## Applications

	Degree of protection of enclosure IP 65
---	---







## Metals

	Aluminium
	Stainless steel, grade 304
	Stainless steel, grade 316
	Stainless steel, grade 316 L
	Stainless steel, grade 316 Ti
	Copper
	Brass
	Steel
	Cast iron
	Die-cast zinc

## Plastics

	Fibre-glass-reinforced plastic
	Petrolatum
	Polyamide
	Polycarbonate
	Polyethylene
	Polypropylene
	Polystyrene

## Surfaces

	Strip-galvanised
	Hot-dip galvanised
	Electro-galvanised
	Hot-dip galvanised
	Copper-plated
	Nickel-plated
	Galvanised, Deltatone 500



## Metallic materials

**Alu** — Aluminium

**VA (1.4301)** — Stainless steel, grade 304

**VA (1.4401)** — Stainless steel, grade 316

**VA (1.4404)** — Stainless steel, grade 316 L

**VA (1.4571)** — Stainless steel, grade 316 Ti

**Cu** — Copper

**CuZn** — Brass

**St** — Steel

**TG** — Cast iron  
Electrogalvanised

**Zn** — Die-cast zinc



# Plastic materials

## GFK — Fibre-glass-reinforced plastic

Temperature resistance:  
-50 to 130 °C.

### Resistant to

High chemical resistance  
Corrosion resistance  
UV light resistance

## PETR — Petrolatum

## PA — Polyamide

Temperature resistance:  
permanently up to approx. 90 °C, briefly up to about 130 °C  
and to about minus 40 °C\*.

Chem. resistance generally as for polyethylene.

### Resistant to

Petrol, benzene, diesel oil, acetone, solvents for paints and lacquers,  
oils and greases.

### Unstable with

Bleach, most acids, chlorine.

### Risk of tension cracking

Low in air-humid conditions; only with some aqueous salt solutions.  
Highly desiccated parts (high temperature and extremely low air  
humidity) are highly sensitive to fuels and various solvents.

## PA/PP — Polyamide/Polyethylene

## PC — Polycarbonate

Temperature resistance:  
permanently up to approx. 110 °C (in water 60 °C), briefly up to 125  
°C, and to below minus 35 °C.

### Resistant to

Petrol, turpentine, most weak acids.

### Unstable with

Acetone, benzene, chlorine, methylene chloride, most concentrated  
acids.

### Risk of tension cracking

Relatively low.

Media which can cause tension cracking include benzene, aromatic  
hydrocarbons, methanol, butanol, acetone, turpentine.

## PE — Polyethylene

Temperature resistance:  
hard types permanently up to about 90 °C, briefly up to about 105 °C,  
soft types permanently up to about 80 °C, briefly up to about 100 °C  
and to about minus 40 °C\*.

### Resistant to

Alkalis and inorganic acids.

### Conditionally resistant to

Acetone, organic acids, petrol, benzene, diesel oil, most oils.

### Unstable with

Chlorine, hydrocarbons, oxidising acids.

### Risk of tension cracking

Relatively high.

Stress cracks can be caused by, among other things, acetone, various  
alcohols, formic acid, ethanol, petrol, benzene, butyric acid, acetic acid,  
formaldehyde, various oils, petroleum, propanol, nitric acid,  
hydrochloric acid, sulphuric acid, soap solutions, turpentine,  
trichloroethylene, citric acid.

## PP — Polypropylene

Temperature resistance:  
permanently up to approx. 90 °C, briefly up to about 110 °C  
and to about minus 30 °C\*.

Chem. resistance generally as for polyethylene.

### Resistant to

Alkalis and inorganic acids.

### Conditionally resistant to

Acetone, organic acids, petrol, benzene, diesel oil, most oils.

### Unstable with

Chlorine, hydrocarbons, oxidising acids.

### Risk of tension cracking

Low, only with some acids such as chromic acid, hydrofluoric acid and  
hydrochloric acid, as well as nitrogen oxide.

## PS — Polystyrene

Temperature resistance:

Because of its relatively high sensitivity to the effects of chemicals, its  
use is not recommended at temperatures above normal room  
temperature, about 25 °C.

Resistance to cold: to about minus 40 °C\*.

### Resistant to

Alkalis, most acids, alcohol.

### Conditionally resistant to

Oils and greases.

### Unstable with

Butyric acid, concentrated nitric acid, concentrated acetic acid,  
acetone, ether, petrol and benzene, solvents for paints and lacquers,  
chlorine, diesel fuel.

### Risk of tension cracking

Relatively high.

Stress cracks can be caused by, amongst other things, acetone, ether,  
petrol, cyclohexane, heptane, methanol, propanol and the softeners  
used in some PVC cable mixes.

\*The minus values apply only for parts in the quiescent condition with  
no severe impact stress.

There is no plastic that is resistant to every chemical. The agents listed  
are only a small selection. Plastic parts are especially at risk in the  
presence of chemicals and high temperatures. Stress cracks may  
occur. If in doubt, please consult us and/or ask for a detailed chemical  
resistance table.

Stress crack formation: stress cracks may occur if plastic parts under  
tension are exposed to chemicals at the same time. Parts made of  
polystyrene and polyethylene are particularly susceptible. Stress cracks  
may even be caused by agents to which the plastic in question is  
resistant in the absence of stress. Typical examples of parts under  
constant stress when used as intended: grip clips, intermediate  
supports of cable glands, ribbon clips.



# Tested lightning protection components

## Tightening torques

M5 = 4 Nm

M6 = 6 Nm

M8 = 12 Nm

M10 = 20 Nm

Detailed data can be provided on request.

# Brief glossary of overvoltage protection

## 100% response lightning impulse voltage

The 100% response lightning impulse voltage is the value of the lightning impulse voltage 1.2/50  $\mu$ s, causing the arrester to switch. With this testing voltage, the surge protection device must respond ten times to ten loads.

## Arrestor

Arrestors are resources, which primarily consist of voltage-dependent resistors and/or spark gaps. Both elements can be switched in series or in parallel or used individually.

Arrestors are used to protect other electrical resources and electrical systems against surge voltages.

## Arrestor measured voltage $V_c$

For arrestors without a spark gap, the measured voltage is the maximum permitted effective value of the mains voltage on the arrester terminals. The measured voltage may constantly be applied to the arrester without changing its operational characteristics.

## Back-up fuse before the arrestors

There must be a back-up fuse before the arrestors. If the upstream fuse is greater than the maximum approved back-up fuse of the arrester elements (see technical data of the device), the arrester must be protected selectively with the required value.

## Cut-off unit

The cut-off unit cuts the arrester off from the mains or the earthing system if it is overloaded, thus preventing a fire risk and also signalling the switch-off of the protection device.

## Equipotential bonding

Electrical connection, which brings the bodies of electrical resources and other conductive parts to the same or almost the same potential.

## Equipotential bonding rail (PAS)

A terminal or rail, intended to connect the protective conductor, the equipotential bonding conductor and, if necessary, the conductor for function earthing with the earthing cable and the earthers.

## Error current protection unit (RCD)

Resource for protection against electric shocks and fire protection (e.g. FI protection switches).

## Lightning protection equipotential bonding system

The lightning protection equipotential bonding is a key measure in reducing the risk of fire and explosion on the room or building to be protected. The lightning protection equipotential bonding is achieved using equipotential bonding cables or arrestors, which connect the external lightning protection system, metallic parts of the building or room, the installation, the other conductive parts and the electrical energy and telecommunications systems.

## Lightning protection system (LPS)

A lightning protection system (LPS) is considered as the entire system used to protect a room or building against the impact of a lightning strike. This includes both internal and external lightning protection.

## Lightning protection zone (LPZ)

Lightning protection zones are those areas in which the electromagnetic environment of the lightning is to be defined and mastered. At the zone transitions, all cables and metallic parts must be integrated into the equipotential bonding system.

## Lightning surge current (Iimp)

A lightning surge current (lightning current carrying capacity per path) is a standardised surge current curve of the shape 10/350  $\mu$ s. With its parameters

- Peak value
- Charge
- Specific energy

it represents the load from natural lightning currents. Type 1 lightning current arrestors (previously requirement class B) must be able to arrest such lightning currents without being destroyed.

## Line follow current quenching (If)

The follow current – also called network follow current – is the current which flows through the surge protection device after an arresting operation and is supplied by the network. The follow current is considerably different from the continuous operating current. The level of the network follow current is dependent on the feed line from the transformer to the arrester.

## Nominal current (In)

The nominal current is the maximum permitted operating current which may be run continually through the appropriately labelled connection terminals.

## Nominal discharge surge current (In)

Peak value of the current flowing through the arrester with the wave shape 8/20. It is used to classify the testing of surge arrestors of type 2 (formerly requirements Class C).

## Nominal frequency (fn)

The nominal frequency is that frequency for which a resource is measured, by which it is called and upon which other nominal parameters refer.

## Nominal voltage (Vn)

The rated voltage is the voltage value for which a resource is designed. In so doing it might be a direct voltage value or the effective value of a sine-form alternating voltage.

## Surge protection device (ÜSG)

A device intended for the limitation of transient surge voltages and arresting of surge voltages. It contains at least one non-linear construction element. In general speech, surge protection devices are also termed arrestors.

## Protection level (Up)

The protection level is the highest current voltage value on the terminals of the surge protection device before response.

## Residual voltage (Vres)

The peak voltage value, occurring via the terminals of the surge protection device during or immediately after the arresting surge current has flowed.

## Short-circuit resistance

The surge protection device must be able to conduct the short-circuit current, until it is either interrupted by the device itself or by an internal or external cut-off unit or by mains-side over-current protection (e.g. back-up fuse).

## Response time (ta)

The response time primarily characterises the response behaviour of the individual protection elements used in arrestors. Depending on the slope  $du/dt$  of the surge voltage or  $di/dt$  of the surge current, the response times may vary within specific limits.

## SPD

Surge protection device.

## Surge arrester, type 1

Arrestors, which, due to their special structure, are able to arrest lightning currents or partial lightning currents during direct strikes.

## Surge arrester, type 2

Arrestors, which are able to arrest surge voltages caused by remote or nearby strikes or switching actions.

## Surge arrester, type 3

Arrestors, used for surge protection of individual consumers or consumer groups and are employed directly on sockets.

## Surge voltage

A surge voltage is a voltage occurring briefly between conductors or between a conductor and the earth, which exceeds the highest permissible operating voltage value by a long way, but does not have the operating frequency. It can be created by storms or by earthing or short-circuits.

## Temperature range

The operating temperature specifies within which temperature limits the perfect function of the surge protection device is guaranteed.

## Transient surge voltage (TOV)

Temporary surge voltages are short-term (i.e. temporary) surge voltages, which may occur due to errors within the medium and low-voltage network.

## Transmission frequency (fg)

The transmission frequency specifies up to which frequency the insertion damping of the employed resource is less than 3 dB.

## Volume resistance per path, series resistance

The volume resistance per path specifies the ohmic resistance increase of the conductor path per wire caused by the use of the surge protection device.



## Conversion table, cable material

Conversion table, cable material



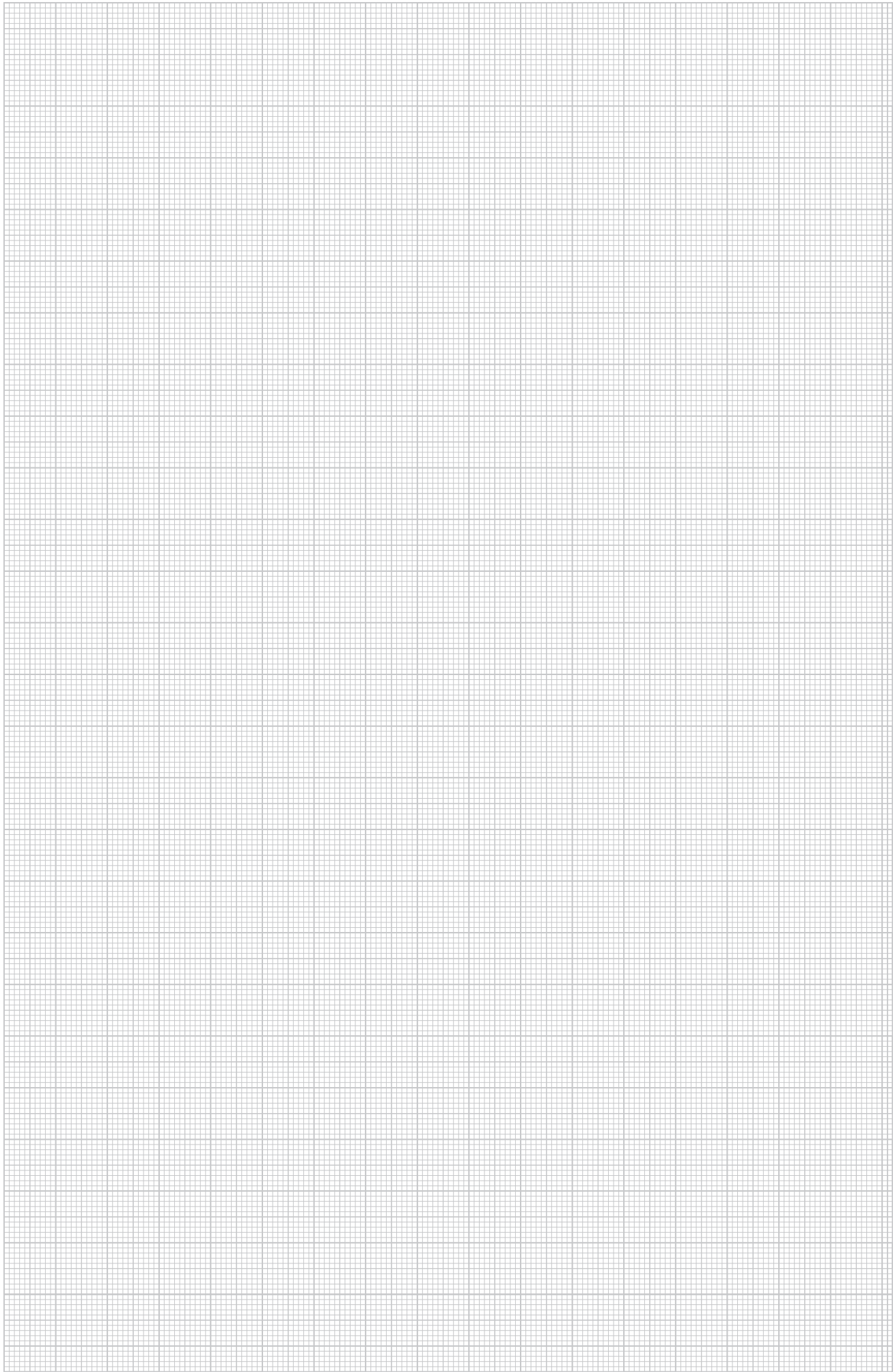

Designation	Item number	Weight approx. (kg/m)	Weight approx. (kg/100 m)	Length approx. (m/kg)
Flat conductor St/FT, 20x2.5	5019340	0.41	41	2.44
Flat conductor St/FT, 25x3	5019342	0.60	59.7	1.68
Flat conductor St/FT, 30x3	5019344	0.71	70.65	1.42
Flat conductor St/FT, 30x3.5	5019345/5019347	0.84	84	1.19
Flat conductor St/FT, 30x4	5019350	0.97	97	1.03
Flat conductor St/FT, 40x4	5019355	1.28	128	0.78
Flat conductor St/FT, 40x5	5019360	1.62	162	0.62
Flat conductor copper, 20x2.5	5021804	0.45	44.5	2.25
Flat conductor VA, 30x3.5	5018501 (V2A) 5018706 (V4A) 5018730 (V4A)	0.83	82.5	1.21
St/FT round cable, 8 mm	5021081	0.40	40	2.50
St/FT round cable, 10 mm	5021103	0.63	63	1.59
Aluminium round cable, 8 mm	5021286 5021294	0.14	13.5	7.41
Aluminium round cable, 10 mm	5021308	0.21	21	4.76
Copper round cable, 8 mm	5021480	0.45	45	2.22
Copper round cable, 10 mm	5021502	0.70	70	1.43
VA round cable, 8 mm	5021235 (V2A) 5021644 (V4A)	0.40	40	2.50
VA round cable, 10 mm	5021227 (V2A) 5021239 (V2A) 5021642 (V4A) 5021647 (V4A)	0.63	63	1.59
St/FT round cable with PVC jacket, 10 mm	5021162	0.67	67.2	1.49
Aluminium round cable with PVC jacket, 8 mm	5021332	0.20	20	5.00
Copper cable, 9 mm	5021650	0.45	44.5	2.25
Copper cable, 10.5 mm	5021654	0.59	58.6	1.71







## Surge protection device for energy technology, arrester, type 1 (industry)

	Combination arrester	136
	Combination arrester in VG housing	138
	Lightning current arrester	140
	Accessories, upper parts and bases	142



# Combination arrester/ MCD, 255 V for TN-S and TT networks

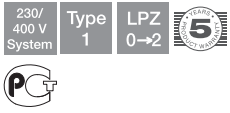

## Combination arrester, surge arrester, type 1

- Protection level < 1.3 kV allows device protection
- For lightning protection equipotential bonding to VDE 0185-305 (IEC 62305)
- Lightning current arresting capacity to 50 kA (10/350) per pole and up to 150 kA (10/350) in total
- Line following current quenching 25 kA I<sub>peak</sub>, arrester backup fuse to 500 A gL/gG
- Suitable for use in pre-meter area according to the VDEW directive
- Encapsulated, non-extinguishing spark gap arrester for use in distributor housings

Application: Industrial systems and buildings with external lightning protection of the highest class I to IV.

### Combination arrester, 3-pole + NPE



Type	Max. continuous operating voltage V	Version	Pack. pcs	Weight kg/100 pcs.	Item No.
<b>MCD 50-B 3+1</b>	255	3 + NPE	1	168.000	<b>5096 87 9</b>

/pc.

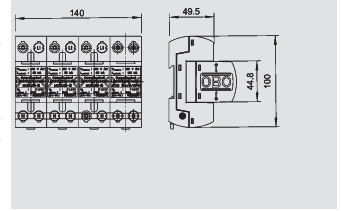

### Combination arrester, 3-pole + NPE with function display



Type	Max. continuous operating voltage V	Version	Pack. pcs	Weight kg/100 pcs.	Item No.
<b>MCD 50-B 3+1-OS</b>	255	3 + NPE	1	172.000	<b>5096 83 6</b>

/pc.

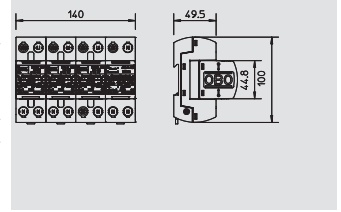

### Combination arrester, 1-pole NPE



Type	Max. continuous operating voltage V	Version	Pack. pcs	Weight kg/100 pcs.	Item No.
<b>MCD 125-B NPE</b>	255	NPE	1	46.500	<b>5096 86 5</b>

/pc.

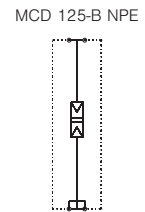
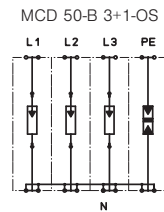
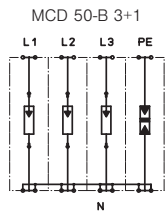
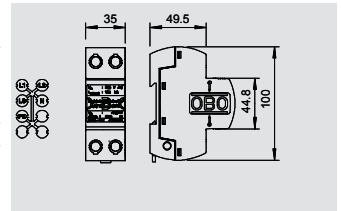

Nominal voltage	U <sub>N</sub>	V	230	230	230
SPD to EN 61643-11			Type 1	Type 1	Type 1
SPD to IEC 61643-11			class I	class I	class I
Lightning protection Zone LPZ			0→2	0→2	0→2
Impulse discharge current (10/350)	I <sub>imp</sub>	kA	50	50	125
Total discharge current (10/350)	I <sub>Total</sub>	kA	125	125	125
Nominal discharge current (8/20)	I <sub>n</sub>	kA	50	50	125
Total discharge current (8/20)	I <sub>Total</sub>	kA	125	125	125
Voltage protection level	U <sub>p</sub>	kV	1,3	1,3	<1,3
Response time	t <sub>A</sub>	ns	<100	<100	<100
Follow current interrupt rating	I <sub>ti</sub>	kA	25	25	0.1
Maximum back-up fuse		A	500	500	
Temperature range	θ	°C	-40 - +85	-40 - +85	-40 - +85
Division unit TE (17.5 mm)			8	8	2
Degree of protection of enclosure			IP20	IP20	IP20
Connection cross-section, rigid		mm <sup>2</sup>	10 - 50	10 - 50	10 - 50
Connection cross-section, multi-wire		mm <sup>2</sup>	10 - 35	10 - 35	10 - 35
Connection cross-section, flexible		mm <sup>2</sup>	10 - 25	10 - 25	10 - 25
<b>Item No.</b>			<b>5096 87 9</b>	<b>5096 83 6</b>	<b>5096 86 5</b>



# Combination arrester MCD, 255 V for TN networks

Combination arrester, surge arrester, type 1

- Protection level < 1.3 kV allows device protection
- For lightning protection equipotential bonding to VDE 0185-305 (IEC 62305)
- Lightning current arresting capacity to 50 kA (10/350) per pole and up to 150 kA (10/350) in total
- Line following current quenching 25 kA I<sub>peak</sub>, arrester backup fuse to 500 A gL/gG
- Suitable for use in pre-meter area according to the VDEW directive
- Encapsulated, non-extinguishing spark gap arrester for use in distributor housings



Application: Industrial systems and buildings with external lightning protection of the highest class I to IV.

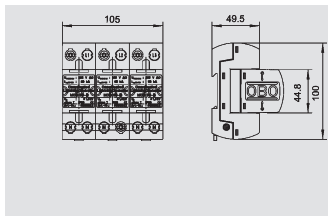

## Combination arrester, 3-pole

Type	Max. continuous operating voltage V	Version	Pack. pcs	Weight kg/100 pcs.	Item No.
<b>MCD 50-B 3</b>	255	3-pole	1	117.000	<b>5096 87 7</b>

/pc.

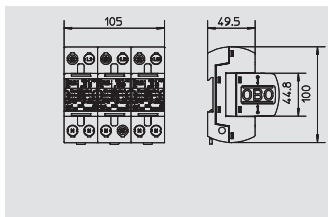

## Combination arrester, 3-pole with function display

Type	Max. continuous operating voltage V	Version	Pack. pcs	Weight kg/100 pcs.	Item No.
<b>MCD 50-B 3-OS</b>	255	3-pole	1	118.000	<b>5096 83 5</b>

/pc.

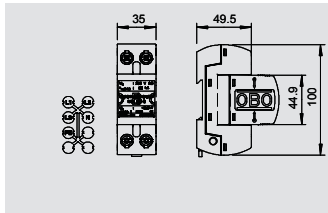

## Combination arrester, 1-pole

Type	Max. continuous operating voltage V	Version	Pack. pcs	Weight kg/100 pcs.	Item No.
<b>MCD 50-B</b>	255	1-pole	1	34.400	<b>5096 84 9</b>

/pc.

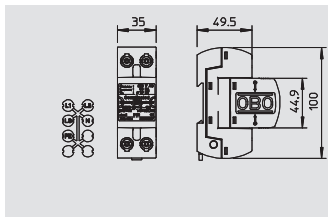

## Combination arrester, 1-pole with function display

Type	Max. continuous operating voltage V	Version	Pack. pcs	Weight kg/100 pcs.	Item No.
<b>MCD 50-B-OS</b>	255	1-pole	1	34.800	<b>5096 85 2</b>

/pc.



MCD 50-B 3

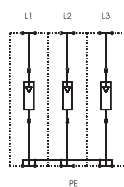

MCD 50-B 3-OS

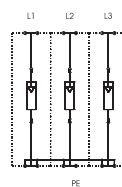

MCD 50-B

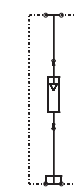

MCD 50-B-OS

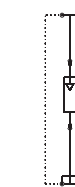

	U <sub>N</sub>	V	230	230	230	230
Nominal voltage						
SPD to EN 61643-11			Type 1	Type 1	Type 1	Type 1
SPD to IEC 61643-11			class I	class I	class I	class I
Lightning protection Zone LPZ			0→2	0→2	0→2	0→2
Impulse discharge current (10/350)	I <sub>imp</sub>	kA	50	50	50	50
Total discharge current (10/350)	I <sub>Total</sub>	kA	150	150	50	50
Nominal discharge current (8/20)	I <sub>n</sub>	kA	50	50	50	50
Total discharge current (8/20)	I <sub>Total</sub>	kA	150	150	50	50
Voltage protection level	U <sub>p</sub>	kV	1,3	1,3	<1,3	1,3
Response time	t <sub>A</sub>	ns	<100	<100	<100	<100
Follow current interrupt rating	I <sub>li</sub>	kA	25	25	25	25
Maximum back-up fuse		A	500	500	500	500
Temperature range	θ	°C	-40 - +85	-40 - +85	-40 - +85	-40 - +85
Division unit TE (17,5 mm)			6	6	2	2
Degree of protection of enclosure			IP20	IP20	IP20	IP20
Connection cross-section, rigid		mm <sup>2</sup>	10 - 50	10 - 50	10 - 50	10 - 50
Connection cross-section, multi-wire		mm <sup>2</sup>	10 - 35	10 - 35	10 - 35	10 - 35
Connection cross-section, flexible		mm <sup>2</sup>	10 - 25	10 - 25	10 - 25	10 - 25
<b>Item No.</b>			<b>5096 87 7</b>	<b>5096 83 5</b>	<b>5096 84 9</b>	<b>5096 85 2</b>

# Combination arrester in VG housing for TN-S and TT network systems

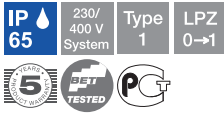

- System solution in insulating housing (IP65), surge arrester, type 1
- For lightning protection equipotential bonding to VDE 0185-305 (IEC 62305)
  - Lightning current arresting capacity to 50 kA (10/350) per pole and up to 125 kA (10/350) in total
  - Line following current quenching 25 kA Ipeak, arrester backup fuse to 500 A gL/gG
  - Suitable for use in pre-meter area according to the VDEW directive
  - Encapsulated, non-extinguishing spark gap arrester, preterminated in insulated housing (IP65)

Application: Industrial systems and buildings with external lightning protection of the highest class I to IV.



## VG housing with MC 50-B/3+1

Type	Max. continuous operating voltage V	Version	Pack. pcs	Weight kg/100 pcs.	Item No.
<b>VG 4-B TNS+TT</b>	255	3 + NPE	1	290.000	<b>5089 20 0</b>

/pc.

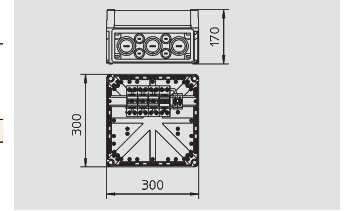

## VG housing with MCD 50-B/3+1

Type	Max. continuous operating voltage V	Version	Pack. pcs	Weight kg/100 pcs.	Item No.
<b>MCD 50-B 3+1-VG</b>	255	3 + NPE	1	290.000	<b>5096 87 5</b>

/pc.

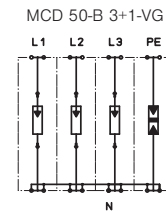
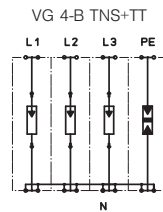
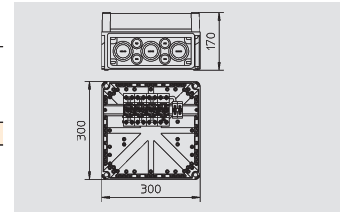

Nominal voltage	$U_N$	V	230
SPD to EN 61643-11			Type 1
SPD to IEC 61643-11			class I
Lightning protection Zone LPZ			0-2
Impulse discharge current (10/350)	$I_{imp}$	kA	50
Total discharge current (10/350)	$I_{Total}$	kA	125
Nominal discharge current (8/20)	$I_n$	kA	50
Total discharge current (8/20)	$I_{Total}$	kA	125
Voltage protection level	$U_p$	kV	<2,0
Response time	$t_A$	ns	<100
Follow current interrupt rating	$I_{fi}$	kA	25
Maximum back-up fuse		A	500
Temperature range	$\vartheta$	°C	-40 - +85
Division unit TE (17.5 mm)			8
Degree of protection of enclosure			IP54
Connection cross-section, rigid		mm <sup>2</sup>	10 - 50
Connection cross-section, multi-wire		mm <sup>2</sup>	10 - 35
Connection cross-section, flexible		mm <sup>2</sup>	10 - 25
<b>Item No.</b>			<b>5089 20 0</b> <b>5096 87 5</b>

# Combination arrester in VG housing for TN-C network systems

System solution in insulating housing (IP65), surge arrester, type 1

- For lightning protection equipotential bonding to VDE 0185-305 (IEC 62305)
- Lightning current arresting capacity to 50 kA (10/350) per pole and up to 150 kA (10/350) in total
- Line following current quenching 25 kA I<sub>peak</sub>, arrester backup fuse to 500 A gL/gG
- Suitable for use in pre-meter area according to the VDEW directive
- Encapsulated, non-extinguishing spark gap arrester, preterminated in insulated housing (IP65)

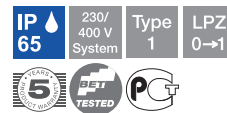

Application: Industrial systems and buildings with external lightning protection of the highest Class I to IV.

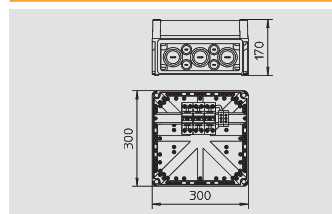

## VG housing with MC 50-B/3

Type	Max. continuous operating voltage V	Version	Pack. pcs	Weight kg/100 pcs.	Item No.
<b>VG 3-B TNC</b>	255	3-pole	1	315.000	<b>5089 21 2</b>

/pc.

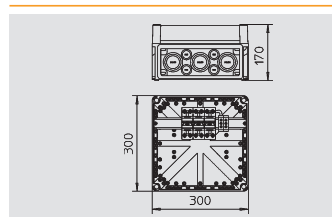

## VG housing with MCD 50-B/3

Type	Max. continuous operating voltage V	Version	Pack. pcs	Weight kg/100 pcs.	Item No.
<b>MCD 50-B 3-VG</b>	255	3-pole	1	315.000	<b>5096 87 4</b>

/pc.



VG 3-B TNC

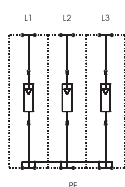

MCD 50-B 3-VG

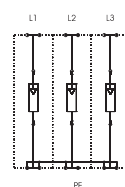

Nominal voltage	$U_N$	V	230	230
SPD to EN 61643-11			Type 1	Type 1
SPD to IEC 61643-11			class I	class I
Lightning protection Zone LPZ			0-1	0-2
Impulse discharge current (10/350)	$I_{imp}$	kA	50	50
Total discharge current (10/350)	$I_{Total}$	kA	150	150
Nominal discharge current (8/20)	$I_n$	kA	50	50
Total discharge current (8/20)	$I_{Total}$	kA	150	150
Voltage protection level	$U_p$	kV	<2,0	<1,3
Response time	$t_A$	ns	<100	<100
Follow current interrupt rating	$I_{li}$	kA	25	25
Maximum back-up fuse		A	500	500
Temperature range	$\vartheta$	°C	-40 - +85	-40 - +85
Division unit TE (17,5 mm)			6	6
Degree of protection of enclosure			IP54	IP54
Connection cross-section, rigid		mm <sup>2</sup>	10 - 50	10 - 50
Connection cross-section, multi-wire		mm <sup>2</sup>	10 - 35	10 - 35
Connection cross-section, flexible		mm <sup>2</sup>	10 - 25	10 - 25
<b>Item No.</b>			<b>5089 21 2</b>	<b>5096 87 4</b>



# Lightning current arrester MC, 255 V for TN-S and TT networks



## Surge arrester, type 1

- For lightning protection equipotential bonding to VDE 0185-305 (IEC 62305)
- Lightning current arresting capacity to 50 kA (10/350) per pole and up to 150 kA (10/350) in total
- Line following current quenching 25 kA Ipeak, arrester backup fuse to 500 A gL/gG
- Suitable for use in pre-meter area according to the VDEW directive
- Encapsulated, non-extinguishing spark gap arrester for use in distributor housings

Application: Industrial systems and buildings with external lightning protection of the highest class I to IV.

## Lightning current arrester, 3-pole + NPE



Type	Max. continuous operating voltage V	Version	Pack. pcs	Weight kg/100 pcs.	Item No.
<b>MC 50-B 3+1</b>	255	3 + NPE	1	168.000	<b>5096 87 8</b>

/pc.

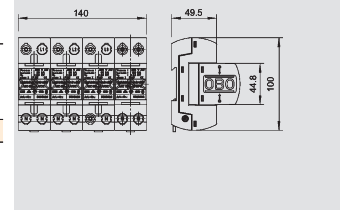

## Lightning current arrester, 1-pole NPE



Type	Max. continuous operating voltage V	Version	Pack. pcs	Weight kg/100 pcs.	Item No.
<b>MC 125-B NPE</b>	255	NPE	1	52.000	<b>5096 86 3</b>

/pc.

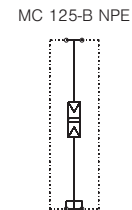
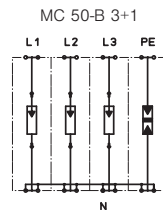
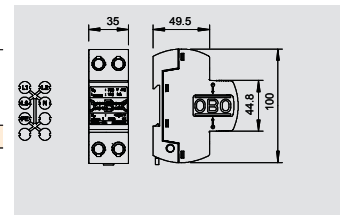

Nominal voltage	$U_N$	V	230
SPD to EN 61643-11			Type 1
SPD to IEC 61643-11			class I
Lightning protection Zone LPZ			0-1
Impulse discharge current (10/350)	$I_{imp}$	kA	50
Total discharge current (10/350)	$I_{Total}$	kA	125
Nominal discharge current (8/20)	$I_n$	kA	50
Total discharge current (8/20)	$I_{Total}$	kA	125
Voltage protection level	$U_p$	kV	< 2,0
Response time	$t_A$	ns	<100
Follow current interrupt rating	$I_{fi}$	kA	25
Maximum back-up fuse		A	500
Temperature range	$\vartheta$	°C	-40 - +85
Division unit TE (17.5 mm)			8
Degree of protection of enclosure			IP20
Connection cross-section, rigid		mm <sup>2</sup>	10 - 50
Connection cross-section, multi-wire		mm <sup>2</sup>	10 - 35
Connection cross-section, flexible		mm <sup>2</sup>	10 - 25
<b>Item No.</b>			<b>5096 87 8</b>
			<b>5096 86 3</b>

# Lightning current arrester MC, 255 V for TN networks

## Surge arrester, type 1

- For lightning protection equipotential bonding to VDE 0185-305 (IEC 62305)
- Lightning current arresting capacity to 50 kA (10/350) per pole and up to 125 kA (10/350) in total
- Line following current quenching 25 kA I<sub>peak</sub>, arrester backup fuse to 500 A gL/gG
- Suitable for use in pre-meter area according to the VDEW directive
- Encapsulated, non-extinguishing spark gap arrester for use in distributor housings

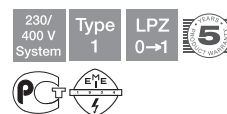

Application: Industrial systems and buildings with external lightning protection of the highest class I to IV.

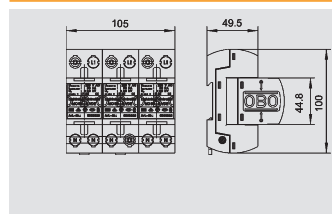

## Lightning current arrester, 3-pole

Type	Max. continuous operating voltage V	Version	Pack. pcs	Weight kg/100 pcs.	Item No.
<b>MC 50-B 3</b>	255	3-pole	1	117.000	<b>5096 87 6</b>

/pc.

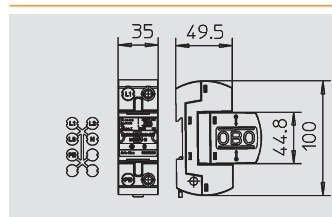

## Lightning current arrester, 1-pole

Type	Max. continuous operating voltage V	Version	Pack. pcs	Weight kg/100 pcs.	Item No.
<b>MC 50-B VDE</b>	255	1-pole	1	34.400	<b>5096 84 7</b>

/pc.

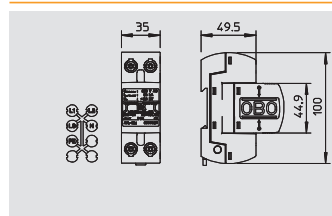

## Lightning current arrester, 1-pole with function display

Type	Max. continuous operating voltage V	Version	Pack. pcs	Weight kg/100 pcs.	Item No.
<b>MC 50-B-OS</b>	255	1-pole	1	34.800	<b>5096 85 1</b>

/pc.

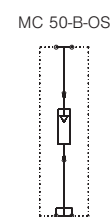
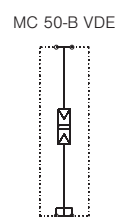
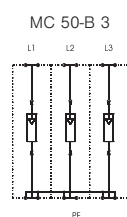

	MC 50-B 3	MC 50-B VDE	MC 50-B-OS
Nominal voltage	U <sub>N</sub> V	230	230
SPD to EN 61643-11		Type 1	Type 1
SPD to IEC 61643-11		class I	class I
Lightning protection Zone LPZ		0-1	0-1
Impulse discharge current (10/350)	I <sub>imp</sub> kA	50	50
Total discharge current (10/350)	I <sub>Total</sub> kA	150	50
Nominal discharge current (8/20)	I <sub>n</sub> kA	50	50
Total discharge current (8/20)	I <sub>Total</sub> kA	150	50
Voltage protection level	U <sub>p</sub> kV	< 2,0	< 2,0
Response time	t <sub>A</sub> ns	<100	<100
Follow current interrupt rating	I <sub>li</sub> kA	25	25
Maximum back-up fuse	A	500	500
Temperature range	θ °C	-40 - +85	-40 - +85
Division unit TE (17,5 mm)		6	2
Degree of protection of enclosure		IP20	IP20
Connection cross-section, rigid	mm <sup>2</sup>	10 - 50	10 - 50
Connection cross-section, multi-wire	mm <sup>2</sup>	10 - 35	10 - 35
Connection cross-section, flexible	mm <sup>2</sup>	10 - 25	10 - 25
<b>Item No.</b>		<b>5096 87 6</b>	<b>5096 84 7</b>
			<b>5096 85 1</b>

## Accessories, covers and bases



### Combination arrester upper part

Type	Max. continuous operating voltage V	Version	Pack. pcs	Weight kg/100 pcs.	Item No.
<b>MCD 50-B 0</b>	255	1-pole	1	19.200	<b>5096 82 2</b>

/pc.

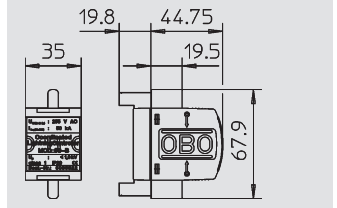

### Upper part, combination arrester with function display

Type	Max. continuous operating voltage V	Version	Pack. pcs	Weight kg/100 pcs.	Item No.
<b>MCD 50-B 0-OS</b>	255	1-pole	1	19.500	<b>5096 82 7</b>

/pc.

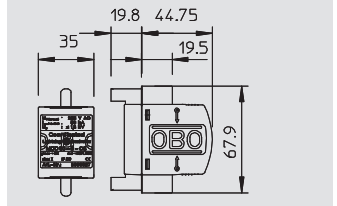

### Upper part, lightning current arrester

Type	Max. continuous operating voltage V	Version	Pack. pcs	Weight kg/100 pcs.	Item No.
<b>MC 50-B 0 VDE</b>	255	1-pole	1	24.000	<b>5096 82 0</b>

/pc.

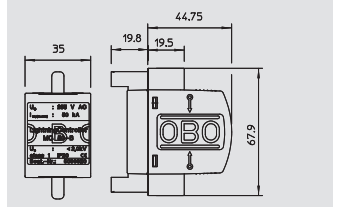

### Upper part, lightning current arrester with function display

Type	Max. continuous operating voltage V	Version	Pack. pcs	Weight kg/100 pcs.	Item No.
<b>MC 50-B 0-OS</b>	255	1-pole	1	19.500	<b>5096 82 5</b>

/pc.

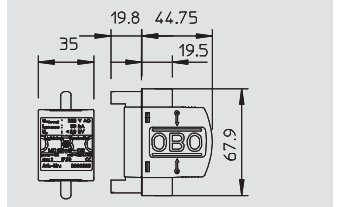

MCD 50-B 0

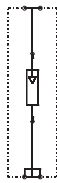

MCD 50-B 0-OS

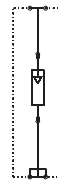

MC 50-B 0 VDE

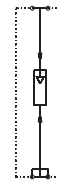

MC 50-B 0-OS

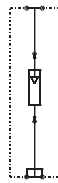

Nominal voltage	$U_N$	V	230	230	230	230
SPD to EN 61643-11			Type 1	Type 1	Type 1	Type 1
SPD to IEC 61643-11			class I	class I	class I	class I
Lightning protection Zone LPZ			0→2	0→2	0→1	0→1
Impulse discharge current (10/350)	$I_{imp}$	kA	50	50	50	50
Total discharge current (10/350)	$I_{Total}$	kA	50	50	50	50
Nominal discharge current (8/20)	$I_n$	kA	50	50	50	50
Total discharge current (8/20)	$I_{Total}$	kA	50	50	50	50
Voltage protection level	$U_p$	kV	<1,3	1,3	<2,0	< 2,0
Response time	$t_A$	ns	<100	<100	<100	<100
Follow current interrupt rating	$I_{fi}$	kA	25	25	25	25
Maximum back-up fuse		A	500	500	500	500
Temperature range	$\vartheta$	°C	-40 - +85	-40 - +85	-40 - +85	-40 - +85
Division unit TE (17.5 mm)			2	2	2	2
Degree of protection of enclosure			IP20	IP20	IP20	IP20
Connection cross-section, rigid		mm <sup>2</sup>	10 - 50	10 - 50	10 - 50	10 - 50
Connection cross-section, multi-wire		mm <sup>2</sup>	10 - 35	10 - 35	10 - 35	10 - 35
Connection cross-section, flexible		mm <sup>2</sup>	10 - 25	10 - 25	10 - 25	10 - 25
<b>Item No.</b>			<b>5096 82 2</b>	<b>5096 82 7</b>	<b>5096 82 0</b>	<b>5096 82 5</b>

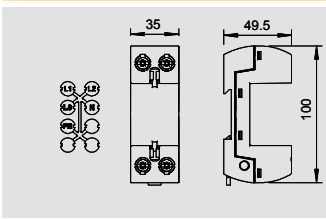

## Lightning arrester/combination arrester base

Type	Version	Pack.	Weight	Item No.
		pcs	kg/100 pcs.	
<b>MC 50-B U VDE</b>	1-pole	1	18.000	<b>5096 83 9</b>

/pc.

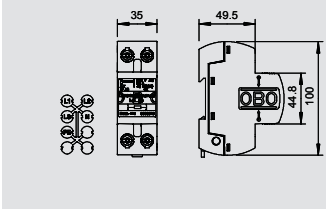

## Decoupling inductivity

Type	Rated current	Version	Version	Pack.	Weight	Item No.
	A			pcs	kg/100 pcs.	
<b>LC 63</b>	63	1-pole	63 A	1	43.500	<b>5096 97 0</b>

/pc.

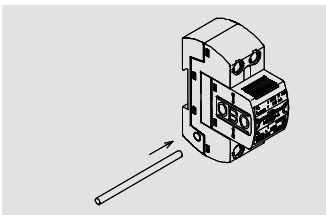

## Connecting bridge

Type	Version	Pack.	Weight	Item No.
		pcs	kg/100 pcs.	
<b>MC V3</b>	3-pole	10	1.700	<b>5096 88 4</b>
<b>MC V4</b>	4-pole	10	2.300	<b>5096 88 6</b>

**Cu** Copper

/pc.

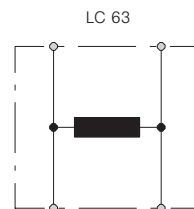





Max. continuous operating voltage	$U_c$	V	500
Rated current	$I_n$	A	63
Inductivity	$L_n$	$\mu$ H	5
Maximum back-up fuse		A	63
Temperature range	$\vartheta$	$^{\circ}$ C	-40 - +85
Degree of protection of enclosure			IP 20
Division unit TE (17.5 mm)			2
Connection cross-section, rigid		mm <sup>2</sup>	10 - 50
Connection cross-section, multi-wire		mm <sup>2</sup>	10 - 35
Connection cross-section, flexible		mm <sup>2</sup>	10 - 25
<b>Item No.</b>			<b>5096 97 0</b>





## Surge protection energy technology, arrester, type 1+2 (office and housing)

	Combination arrester	V50, 280 V	148
	Accessories, upper parts and bases V50		151
	Combination arrester	V25, 150 V	154
		V25, 280 V	156
		V25, 385 V	161
	Accessories, upper parts and bases V25		163
	Combination arrester, protection set for TN and TT network systems		167





## Surge protection energy technology: the plus of the V50+B+C family

- + Connectable lightning current and surge arrestor
- + High arresting capacity up to 50 kA (10/350)
- + Combination arrestor for buildings with lightning protection
- + Visual status display
- + Available with optional remote signalling
- + Vibration-proof through Shock Guard
- + Simple standard hat rail mounting
- + Labelled connections
- + Usable in systems with lightning protection class 3



### Function and areas of use

The combination lightning and surge arrestors V50 meet the type 1 requirement class according to IEC 61643-11. These devices protect low voltage consumer systems from overvoltages of all

types, and are available in single-pole to four-pole versions. The voltage-limiting high-performance zinc oxide varistor provides several benefits. An extremely short response time, a low protection level and high current leakage capability with long service life. In addition,

the devices do not produce any line follow current. If circumstances are uncertain and there is a risk of fire from overloads, the cut-off unit disconnects the arrestor safely from the mains.



# Combination arrester V50, 280 V for TN and TT network systems



- Combination arrester, lightning current and surge arrester, type 1+2
- For lightning protection equipotential bonding to VDE 0185-305 (IEC 62305)
  - Lightning current arresting capacity 12.5 kA (10/350) per pole and up to 50 kA (10/350) in total
  - Arrester, plug-in, with dynamic cut-off unit and visual function display
  - Encapsulated, non-extinguishing zinc oxide varistor arrester for use in distributor housings

Application: Residential building with external lightning protection of Class III and IV.



## Lightning current and surge arrester, 1-pole + NPE

Type	Max. continuous operating voltage V	Version	Pack. pcs	Weight kg/100 pcs.	Item No.
<b>V50-B+C 1+NPE</b>	280	1 + NPE	1	31.300	<b>5093 65 3</b>

/pc.

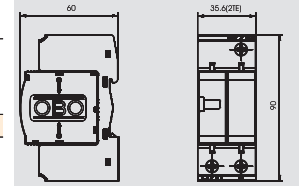

## Lightning current and surge arrester, 2-pole + NPE

Type	Max. continuous operating voltage V	Version	Pack. pcs	Weight kg/100 pcs.	Item No.
<b>V50-B+C 2+NPE</b>	280	2 + NPE	1	32.000	<b>5093 65 5</b>

/pc.

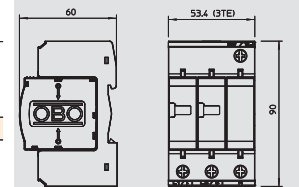

## Lightning current and surge arrester, 3-pole + NPE

Type	Max. continuous operating voltage V	Version	Pack. pcs	Weight kg/100 pcs.	Item No.
<b>V50-B+C 3+NPE</b>	280	3+NPE	1	55.000	<b>5093 65 4</b>

/pc.

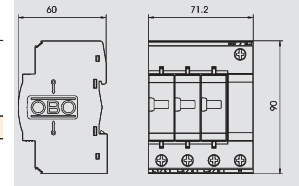

V50-B+C 1+NPE

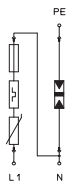

V50-B+C 2+NPE

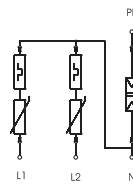

V50-B+C 3+NPE

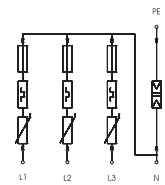

Nominal voltage	$U_N$	V	230	230	230
SPD to EN 61643-11			Type 1+2	Type 1+2	Type 1+2
SPD to IEC 61643-11			class I+II	class I+II	class I+II
Lightning protection Zone LPZ			0→2	0→2	0→2
Impulse discharge current (10/350)	$I_{imp}$	kA	12,5	12,5	12,5
Total discharge current (10/350)	$I_{Total}$	kA	25	25	50
Nominal discharge current (8/20)	$I_n$	kA	30	30	30
Total discharge current (8/20)	$I_{Total}$	kA	50	50	50
Maximum discharge current	$I_{max}$	kA	50	50	50
Voltage protection level	$U_p$	kV	< 1,3	< 1,3	< 1,3
Response time	$t_A$	ns	<25	<25	<25
Maximum back-up fuse		A	125	125	125
Temperature range	$\vartheta$	°C	-40 - +80	-40 - +80	-40 - +80
Division unit TE (17.5 mm)			2	3	4
Degree of protection of enclosure			IP20	IP20	IP20
Connection cross-section, rigid		mm <sup>2</sup>	2,5 - 35	2,5 - 35	2,5 - 35
Connection cross-section, multi-wire		mm <sup>2</sup>	2,5 - 35	2,5 - 35	2,5 - 35
Connection cross-section, flexible		mm <sup>2</sup>	2,5 - 25	2,5 - 25	2,5 - 25
<b>Item No.</b>			<b>5093 65 3</b>	<b>5093 65 5</b>	<b>5093 65 4</b>

# Combination arrester V50, 280 V for TN and TT network systems

Combination arrester, lightning current and surge arrester, type 1+2

- For lightning protection equipotential bonding to VDE 0185-305 (IEC 62305)
- Lightning current arresting capacity 12.5 kA (10/350) per pole and up to 50 kA (10/350) in total
- Arrester, plug-in, with dynamic cut-off unit and visual function display
- Encapsulated, non-extinguishing zinc oxide varistor arrester for use in distributor housings



Application: Residential building with external lightning protection of Class III and IV.

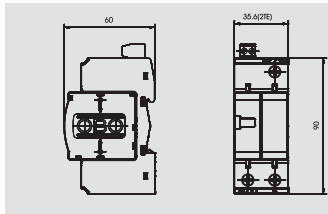

## Lightning current and surge arrester, 1-pole + NPE with remote signalling

Type	Max. continuous operating voltage V	Version	Pack. pcs	Weight kg/100 pcs.	Item No.
V50-B+C 1+NPE+FS	280	1+NPE with FS	1	26.100	5093 66 1

/pc.

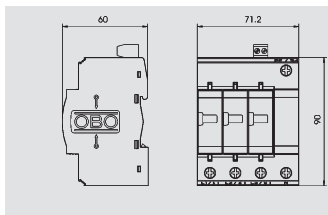

## Lightning current and surge arrester, 3-pole + NPE with remote signalling

Type	Max. continuous operating voltage V	Version	Pack. pcs	Weight kg/100 pcs.	Item No.
V50-B+C 3+NPE+FS	280	3+NPE with FS	1	55.000	5093 66 2

/pc.



V50-B+C 1+NPE+FS

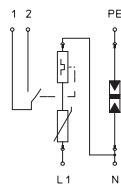

V50-B+C 3+NPE+FS

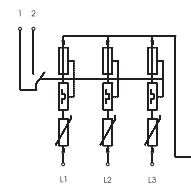

Nominal voltage	$U_N$	V	230	230
SPD to EN 61643-11			Type 1+2	Type 1+2
SPD to IEC 61643-11			class I+II	class I+II
Lightning protection Zone LPZ			0-2	0-2
Impulse discharge current (10/350)	$I_{imp}$	kA	12,5	12,5
Total discharge current (10/350)	$I_{Total}$	kA	25	50
Nominal discharge current (8/20)	$I_n$	kA	30	30
Total discharge current (8/20)	$I_{Total}$	kA	50	50
Maximum discharge current	$I_{max}$	kA	50	50
Voltage protection level	$U_p$	kV	< 1,3	< 1,3
Response time	$t_A$	ns	<25	<25
Maximum back-up fuse		A	125	125
Temperature range	$\vartheta$	°C	-40 - +80	-40 - +80
Division unit TE (17,5 mm)			2	4
Degree of protection of enclosure			IP20	IP20
Connection cross-section, rigid		mm <sup>2</sup>	2,5 - 35	2,5 - 35
Connection cross-section, multi-wire		mm <sup>2</sup>	2,5 - 35	2,5 - 35
Connection cross-section, flexible		mm <sup>2</sup>	2,5 - 25	2,5 - 25
<b>Item No.</b>			<b>5093 66 1</b>	<b>5093 66 2</b>



# Combination arrester V50, 280 V for TN-C network systems



- Combination arrester, lightning current and surge arrester, type 1+2
- For lightning protection equipotential bonding to VDE 0185-305 (IEC 62305)
  - Lightning current arresting capacity 12.5 kA (10/350) per pole and up to 50 kA (10/350) in total
  - Arrester, plug-in, with dynamic cut-off unit and visual function display
  - Encapsulated, non-extinguishing zinc oxide varistor arrester for use in distributor housings

Application: Residential building with external lightning protection of Class III and IV.



## Lightning current and surge arrester, 3-pole

Type	Max. continuous operating voltage V	Version	Pack. pcs	Weight kg/100 pcs.	Item No.
<b>V50-B+C 3-280</b>	280	3-pole	1	42.300	<b>5093 62 7</b>

/pc.

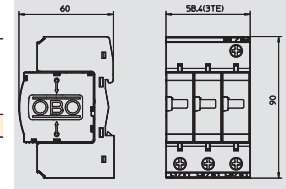

## Lightning current and surge arrester, 3-pole with remote signalling

Type	Max. continuous operating voltage V	Version	Pack. pcs	Weight kg/100 pcs.	Item No.
<b>V50-B+C 3+FS280</b>	280	3-pole with FS	1	43.000	<b>5093 64 3</b>

/pc.

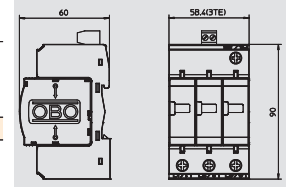

## Lightning current and surge arrester, 4-pole

Type	Max. continuous operating voltage V	Version	Pack. pcs	Weight kg/100 pcs.	Item No.
<b>V50-B+C 4</b>	280	4-pole	1	53.000	<b>5093 63 1</b>

/pc.

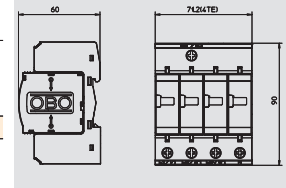

## Lightning current and surge arrester, 4-pole with remote signalling

Type	Max. continuous operating voltage V	Version	Pack. pcs	Weight kg/100 pcs.	Item No.
<b>V50-B+C 4+FS</b>	280	4-pole with FS	1	53.200	<b>5093 64 7</b>

/pc.

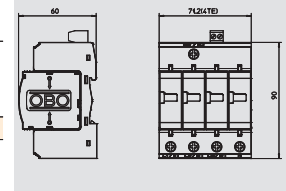

V50-B+C 3-280

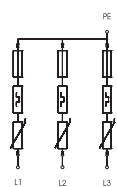

V50-B+C 3+FS280

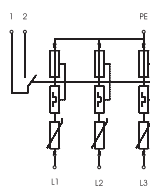

V50-B+C 4

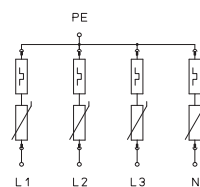

V50-B+C 4+FS

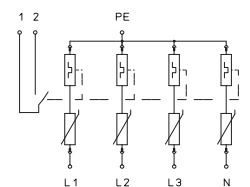

Nominal voltage	$U_N$	V	230	230	230	230
SPD to EN 61643-11			Type 1+2	Type 1+2	Type 1+2	Type 1+2
SPD to IEC 61643-11			class I+II	class I+II	class I+II	class I+II
Lightning protection Zone LPZ			0-2	0-2	0-2	0-2
Impulse discharge current (10/350)	$I_{imp}$	kA	12,5	12,5	12,5	12,5
Total discharge current (10/350)	$I_{Total}$	kA	37,5	37,5	50	50
Nominal discharge current (8/20)	$I_n$	kA	30	30	30	30
Total discharge current (8/20)	$I_{Total}$	kA	90	90	120	120
Maximum discharge current	$I_{max}$	kA	50	50	50	50
Voltage protection level	$U_p$	kV	< 1,3	< 1,3	< 1,3	< 1,3
Response time	$t_A$	ns	<25	<25	<25	<25
Maximum back-up fuse		A	125	125	125	125
Temperature range	$\vartheta$	°C	-40 - +80	-40 - +80	-40 - +80	-40 - +80
Division unit TE (17.5 mm)			3	3	4	4
Degree of protection of enclosure			IP20	IP20	IP20	IP20
Connection cross-section, rigid		mm <sup>2</sup>	2,5 - 35	2,5 - 35	2,5 - 35	2,5 - 35
Connection cross-section, multi-wire		mm <sup>2</sup>	2,5 - 35	2,5 - 35	2,5 - 35	2,5 - 35
Connection cross-section, flexible		mm <sup>2</sup>	2,5 - 25	2,5 - 25	2,5 - 25	2,5 - 25
<b>Item No.</b>			<b>5093 62 7</b>	<b>5093 64 3</b>	<b>5093 63 1</b>	<b>5093 64 7</b>

V 50-B+C/0...: CombiController, upper part – Type 1+2 CombiArrestor



- Plug-in upper part; upper part can be separated from base without tools and current cut-off in bottom part
- Including thermal and dynamic separating device and visual fault display
- High current conductivity and long service life

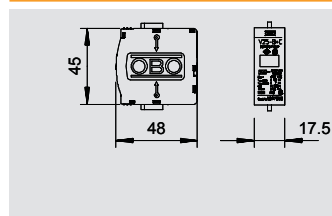

## Combination arrestor upper part 150 V

Type	Max. continuous operating voltage V	U max DC V	Version	Pack. pcs	Weight kg/100 pcs.	Item No.
<b>V 50-B+C 0-150</b>	150	200	1-pole upper part	1	6.500	<b>5094 40 0</b>

/pc.

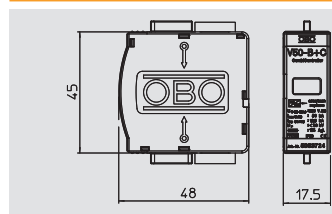

## Combination arrestor upper part 280 V

Type	Max. continuous operating voltage V	U max DC V	Version	Pack. pcs	Weight kg/100 pcs.	Item No.
<b>V50-B+C 0-280</b>	280	350	1-pole upper part	1	8.000	<b>5093 72 4</b>

/pc.



Surge protection, arrestor, type 1+2 (office and housing)



V 50-B+C 0-150

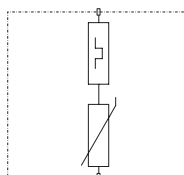

V50-B+C 0-280

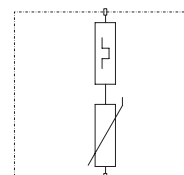

	$U_N$	V	150	230
Nominal voltage			150	230
SPD to EN 61643-11			Type 1+2	Type 1+2
SPD to IEC 61643-11			class I+II	class I+II
Lightning protection Zone LPZ			0-2	0-2
Impulse discharge current (10/350)	$I_{imp}$	kA	12,5	12,5
Total discharge current (10/350)	$I_{Total}$	kA	12,5	12,5
Nominal discharge current (8/20)	$I_n$	kA	30	30
Total discharge current (8/20)	$I_{Total}$	kA	30	30
Maximum discharge current	$I_{max}$	kA	50	50
Voltage protection level	$U_p$	kV	< 1,0	< 1,3
Response time	$t_A$	ns	<25	<25
Maximum back-up fuse		A	125	125
Temperature range	$\vartheta$	°C	-40 - +80	-40 - +80
Division unit TE (17,5 mm)			1	1
Degree of protection of enclosure			IP20	IP20
<b>Item No.</b>			<b>5094 40 0</b>	<b>5093 72 4</b>

## Accessories, upper parts and bases V50



MB...: Base for V 50-B+C, combination arrester, lightning and surge voltage arrester type 1+2 according to DIN EN 61643-11 (B+C according to VDE 0675 part 6).

- Also suitable for V 25-B+C, V 20-C and V10-C
- Pre-mounted and ready for connection
- Multifunction terminals for easy connection to series-mounted devices
- Upper part can be rotated through 180 degrees
- 3+1 protection circuit for TN-S and TT network systems

Application: lightning protection equipotential bonding for buildings also with external lightning protection of Classes III and IV and in standard distributor housings.



### CombiController V50 base

Type	Max. continuous operating voltage V	Version	Pack. pcs	Weight kg/100 pcs.	Item No.
<b>MB 50-3+NPE</b>	280	3+NPE base	1	27.000	<b>5096 67 5</b>

/pc.

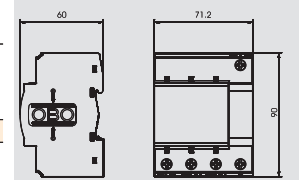

### CombiController V50 base with remote signalling

Type	Max. continuous operating voltage V	Version	Pack. pcs	Weight kg/100 pcs.	Item No.
<b>MB 50-3+NPE+FS</b>	280	3+NPE with FS	1	29.000	<b>5096 67 7</b>

/pc.

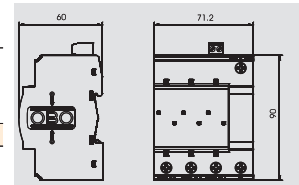

MB 50-3+NPE

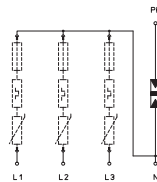

MB 50-3+NPE+FS

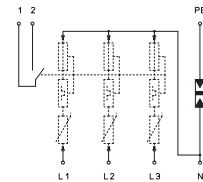

Nominal voltage	$U_N$	V	230		230
SPD to EN 61643-11			Type 1+2		Type 1+2
SPD to IEC 61643-11			class I+II		class I+II
Lightning protection Zone LPZ			0-2		0-2
Total discharge current (10/350)	$I_{Total}$	kA	50		50
Voltage protection level	$U_p$	kV	< 1,3		< 1,3
Response time	$t_A$	ns	<25		<25
Maximum back-up fuse		A	125		125
Temperature range	$\vartheta$	°C	-40 - +80		-40 - +80
Degree of protection of enclosure			IP20		IP20
Division unit TE (17.5 mm)			4		4
Connection cross-section, rigid		mm <sup>2</sup>	2,5 - 35		2,5 - 35
Connection cross-section, multi-wire		mm <sup>2</sup>	2,5 - 35		2,5 - 35
Connection cross-section, flexible		mm <sup>2</sup>	2,5 - 25		2,5 - 25
<b>Item No.</b>			<b>5096 67 5</b>		<b>5096 67 7</b>



## Surge protection energy technology: the plus of the V25-B+C family

- + Connectable lightning current and surge arrestor
- + High arresting capacity
- + Combination arrestor for buildings with lightning protection
- + Visual status display
- + Available with optional remote signalling
- + Vibration-proof through Shock Guard
- + Simple standard hat rail mounting
- + Labelled connections



### Function and areas of use

The surge arrestors V25 meet the type 1+2 requirement class according to IEC 61643-11. These devices protect low voltage consumer systems from overvoltages of all types, and are available in

single-pole to four-pole versions. The voltage-limiting high-performance zinc oxide varistor provides several benefits. An extremely short response time, a low protection level and high current leakage capability with long service life. In

addition, the devices do not produce any line follow current. If circumstances are uncertain and there is a risk of fire from overloads, the cut-off unit disconnects the arrestor safely from the mains.



# Combination arrester V25, 150 V for TN and TT network systems



- Combination arrester, lightning current and surge arrester, type 1+2
- For lightning protection equipotential bonding to VDE 0185-305 (IEC 62305)
  - Lightning current arresting capacity 7 kA (10/350) per pole and up to 25 kA (10/350) in total
  - Arrester, plug-in, with dynamic cut-off unit and visual function display
  - Encapsulated, non-extinguishing zinc oxide varistor arrester for use in distributor housings

Application: Building with outdoor line infeed or lightning risk.



## Combination arrester, 1-pole + NPE

Type	Max. continuous operating voltage V	Version	Pack. pcs	Weight kg/100 pcs.	Item No.
<b>V25-B+C 1NPE150</b>	150	1+NPE	1	24.900	<b>5094 44 8</b>

/pc.

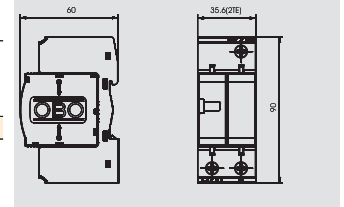

## Combination arrester, 3-pole + NPE

Type	Max. continuous operating voltage V	Version	Pack. pcs	Weight kg/100 pcs.	Item No.
<b>V25-B+C 3NPE150</b>	150	3+NPE	1	45.900	<b>5094 45 4</b>

/pc.

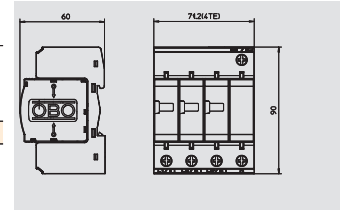

V25-B+C 1NPE150



V25-B+C 3NPE150

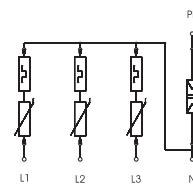

Nominal voltage	$U_N$	V	130	130
SPD to EN 61643-11			Type 1+2	Type 1+2
SPD to IEC 61643-11			class I+II	class I+II
Lightning protection Zone LPZ			0-2	0-2
Impulse discharge current (10/350)	$I_{imp}$	kA	8	8
Total discharge current (10/350)	$I_{Total}$	kA	16	25
Nominal discharge current (8/20)	$I_n$	kA	30	30
Total discharge current (8/20)	$I_{Total}$	kA	60	120
Maximum discharge current	$I_{max}$	kA	50	50
Voltage protection level	$U_p$	kV	<0,6	<0,6
Response time	$t_A$	ns	< 25	< 25
Maximum back-up fuse		A	160	160
Temperature range	$\vartheta$	°C	-40 - +80	-40 - +80
Division unit TE (17.5 mm)			2	4
Degree of protection of enclosure			IP20	IP20
Connection cross-section, rigid		mm <sup>2</sup>	2,5 - 35	2,5 - 35
Connection cross-section, multi-wire		mm <sup>2</sup>	2,5 - 35	2,5 - 35
Connection cross-section, flexible		mm <sup>2</sup>	2,5 - 25	2,5 - 25
<b>Item No.</b>			<b>5094 44 8</b>	<b>5094 45 4</b>

# Combination arrester V25, 150 V

Combination arrester, lightning current and surge arrester, type 1+2

- For lightning protection equipotential bonding to VDE 0185-305 (IEC 62305)
- Lightning current arresting capacity 7 kA (10/350) per pole and up to 25 kA (10/350) in total
- Arrester, plug-in, with dynamic cut-off unit and visual function display
- Encapsulated, non-extinguishing zinc oxide varistor arrester for use in distributor housings



Application: Building with outdoor line infeed or lightning risk.

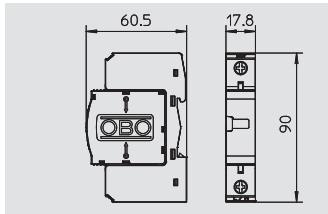

## Combination arrester, 1-pole

Type	Max. continuous operating voltage V	Version	Pack. pcs	Weight kg/100 pcs.	Item No.
<b>V25-B+C 1-150</b>	150	1-pole	1	13.500	<b>5094 40 1</b>

/pc.

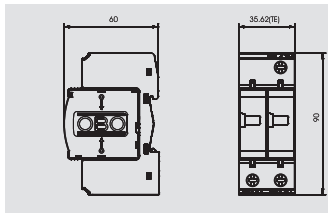

## Combination arrester, 2-pole

Type	Max. continuous operating voltage V	Version	Pack. pcs	Weight kg/100 pcs.	Item No.
<b>V25-B+C 2-150</b>	150	1-pole	1	25.500	<b>5094 40 3</b>

/pc.



V25-B+C 1-150

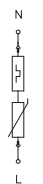

V25-B+C 2-150

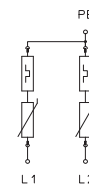

Nominal voltage	$U_N$	V	130	130
SPD to EN 61643-11			Type 1+2	Type 1+2
SPD to IEC 61643-11			class I+II	class I+II
Lightning protection Zone LPZ			0-2	0-2
Impulse discharge current (10/350)	$I_{imp}$	kA	8	25
Total discharge current (10/350)	$I_{Total}$	kA	8	16
Nominal discharge current (8/20)	$I_n$	kA	30	30
Total discharge current (8/20)	$I_{Total}$	kA	30	60
Maximum discharge current	$I_{max}$	kA	50	50
Voltage protection level	$U_p$	kV	<0,6	<0,6
Response time	$t_A$	ns	< 25	< 25
Maximum back-up fuse		A	160	160
Temperature range	$\vartheta$	°C	-40 - +80	-40 - +80
Division unit TE (17,5 mm)			1	2
Degree of protection of enclosure			IP20	IP20
Connection cross-section, rigid		mm <sup>2</sup>	2,5 - 35	2,5 - 35
Connection cross-section, multi-wire		mm <sup>2</sup>	2,5 - 35	2,5 - 35
Connection cross-section, flexible		mm <sup>2</sup>	2,5 - 25	2,5 - 25
<b>Item No.</b>			<b>5094 40 1</b>	<b>5094 40 3</b>



# Combination arrester V25, 280 V for TN and TT network systems

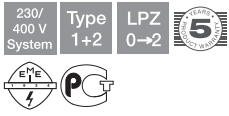

- Combination arrester, lightning current and surge arrester, type 1+2
- For lightning protection equipotential bonding to VDE 0185-305 (IEC 62305)
  - Lightning current arresting capacity 7 kA (10/350) per pole and up to 25 kA (10/350) in total
  - Arrester, plug-in, with dynamic cut-off unit and visual function display
  - Encapsulated, non-extinguishing zinc oxide varistor arrester for use in distributor housings

Application: Building with outdoor line infeed or lightning risk.



## Combination arrester, 1-pole + NPE

Type	Max. continuous operating voltage V	Version	Pack. pcs	Weight kg/100 pcs.	Item No.
<b>V25-B+C 1+NPE</b>	280	1-pole complete with NPE	1	28.000	<b>5094 45 7</b>

/pc.

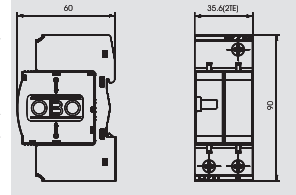

## Combination arrester, 2-pole + NPE

Type	Max. continuous operating voltage V	Version	Pack. pcs	Weight kg/100 pcs.	Item No.
<b>V25-B+C 2+NPE</b>	280	2-pole complete with NPE	1	37.000	<b>5094 46 0</b>

/pc.

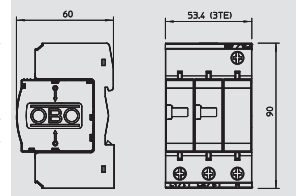

## Combination arrester, 3-pole + NPE

Type	Max. continuous operating voltage V	Version	Pack. pcs	Weight kg/100 pcs.	Item No.
<b>V25-B+C 3+NPE</b>	280	3-pole complete with NPE	1	51.000	<b>5094 46 3</b>

/pc.

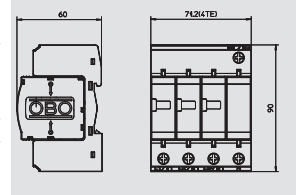

## Combination arrester, 1-pole NPE

Type	Max. continuous operating voltage V	Version	Pack. pcs	Weight kg/100 pcs.	Item No.
<b>C 25-B+C 1</b>	255	NPE	1	12.500	<b>5095 60 6</b>

/pc.

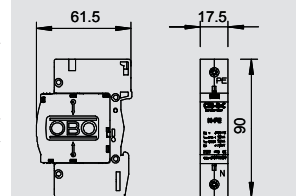

V25-B+C 1+NPE

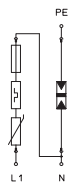

V25-B+C 2+NPE

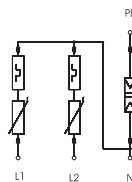

V25-B+C 3+NPE

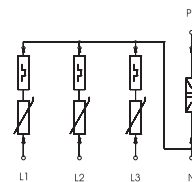

C 25-B+C 1

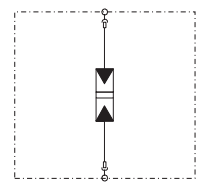

Nominal voltage	$U_N$	V	230	230	230	230
SPD to EN 61643-11			Type 1+2	Type 1+2	Type 1+2	Type 1+2
SPD to IEC 61643-11			class I+II	class I+II	class I+II	class I+II
Lightning protection Zone LPZ			0→2	0→2	0→2	0→2
Impulse discharge current (10/350)	$I_{imp}$	kA	7	7	7	
Total discharge current (10/350)	$I_{Total}$	kA	14	21	25	
Nominal discharge current (8/20)	$I_n$	kA	30	30	30	30
Total discharge current (8/20)	$I_{Total}$	kA	60	90	120	
Maximum discharge current	$I_{max}$	kA	50	50	50	
Voltage protection level	$U_p$	kV	< 0,9	< 0,9	< 0,9	< 1,2
Response time	$t_A$	ns	< 25	< 25	< 25	< 100
Maximum back-up fuse		A	160	160	160	
Temperature range	$\theta$	°C	-40 - +80	-40 - +80	-40 - +80	-40 - +80
Division unit TE (17.5 mm)			2	3	4	1
Degree of protection of enclosure			IP20	IP20	IP20	IP20
Connection cross-section, rigid		mm <sup>2</sup>	2,5 - 35	2,5 - 35	2,5 - 35	2,5 - 35
Connection cross-section, multi-wire		mm <sup>2</sup>	2,5 - 35	2,5 - 35	2,5 - 35	2,5 - 35
Connection cross-section, flexible		mm <sup>2</sup>	2,5 - 25	2,5 - 25	2,5 - 25	2,5 - 25
Lightning impulse current (10/350) (N-PE)	$I_{imp}$	kA				25
Follow current interrupt rating	$I_c$	kA				0.1
<b>Item No.</b>			<b>5094 45 7</b>	<b>5094 46 0</b>	<b>5094 46 3</b>	<b>5095 60 6</b>

# Combination arrester V25, 280 V for TN and TT network systems, with remote signalling

- Combination arrester, lightning current and surge arrester, type 1+2
- For lightning protection equipotential bonding to VDE 0185-305 (IEC 62305)
- Lightning current arresting capacity 7 kA (10/350) per pole and up to 25 kA (10/350) in total
- Arrester, plug-in, with dynamic cut-off unit and visual function display
- Encapsulated, non-extinguishing zinc oxide varistor arrester for use in distributor housings



Application: Building with outdoor line infeed or lightning risk.

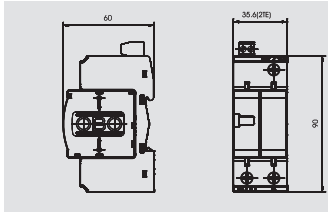

## Combination arrester, 1-pole + NPE with remote signalling

Type	Max. continuous operating voltage V	Version	Pack. pcs	Weight kg/100 pcs.	Item No.
V25-B+C 1+NPE+FS	280	1+NPE with FS	1	27.500	5094 44 4

/pc.

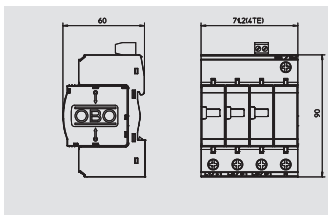

## Combination arrester, 3-pole + NPE with remote signalling

Type	Max. continuous operating voltage V	Version	Pack. pcs	Weight kg/100 pcs.	Item No.
V25-B+C 3+NPE-FS	280	3+NPE with FS	1	52.500	5094 51 0

/pc.

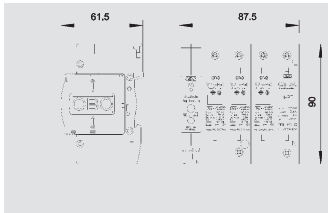

## Combination arrester, 3-pole + NPE, with acoustic signalling

Type	Max. continuous operating voltage V	Version	Pack. pcs	Weight kg/100 pcs.	Item No.
V25-B+C 3+NPE+AS	280	3 + NPE	1	70.000	5097 43 2

/pc.



V25-B+C 1+NPE+FS

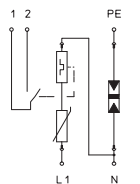

V25-B+C 3+NPE-FS

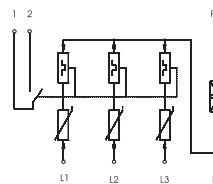

V25-B+C 3+NPE+AS

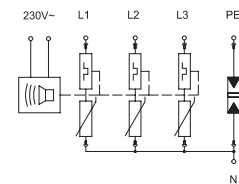

Nominal voltage	$U_N$	V	230	230	230
SPD to EN 61643-11			Type 1+2	Type 1+2	Type 1+2
SPD to IEC 61643-11			class I+II	class I+II	class I+II
Lightning protection Zone LPZ			0-2	0-2	0-2
Impulse discharge current (10/350)	$I_{imp}$	kA	7	7	7
Total discharge current (10/350)	$I_{Total}$	kA	14	25	25
Nominal discharge current (8/20)	$I_n$	kA	30	30	30
Total discharge current (8/20)	$I_{Total}$	kA	60	120	120
Maximum discharge current	$I_{max}$	kA	50	150	50
Voltage protection level	$U_p$	kV	< 0,9	< 0,9	< 0,9
Response time	$t_A$	ns	< 25	< 25	< 25
Maximum back-up fuse		A	160	160	160
Temperature range	$\vartheta$	°C	-40 - +80	-40 - +80	-40 - +80
Division unit TE (17,5 mm)			2	3	5
Degree of protection of enclosure			IP20	IP20	IP20
Connection cross-section, rigid		mm <sup>2</sup>	2,5 - 35	2,5 - 35	2,5 - 35
Connection cross-section, multi-wire		mm <sup>2</sup>	2,5 - 35	2,5 - 35	2,5 - 35
Connection cross-section, flexible		mm <sup>2</sup>	2,5 - 25	2,5 - 25	2,5 - 25
<b>Item No.</b>			<b>5094 44 4</b>	<b>5094 51 0</b>	<b>5097 43 2</b>



# Combination arrester V25, 280 V



- Combination arrester, lightning current and surge arrester, type 1+2
- For lightning protection equipotential bonding to VDE 0185-305 (IEC 62305)
  - Lightning current arresting capacity 7 kA (10/350) per pole and up to 25 kA (10/350) in total
  - Arrester, plug-in, with dynamic cut-off unit and visual function display
  - Encapsulated, non-extinguishing zinc oxide varistor arrester for use in distributor housings

Application: Building with outdoor line infeed or lightning risk.



## Combination arrester, 1-pole

Type	Max. continuous operating voltage V	Version	Pack. pcs	Weight kg/100 pcs.	Item No.
<b>V25-B+C 1-280</b>	280	1-pole	1	15.300	<b>5094 41 8</b>

/pc.

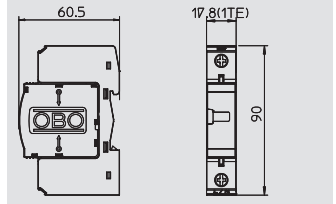

## Combination arrester, 2-pole

Type	Max. continuous operating voltage V	Version	Pack. pcs	Weight kg/100 pcs.	Item No.
<b>V25-B+C 2-280</b>	280	2-pole	1	28.500	<b>5094 42 1</b>

/pc.

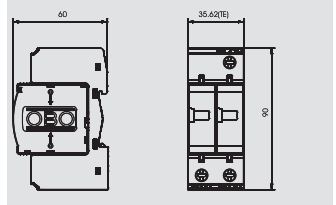

## Combination arrester, 3-pole

Type	Max. continuous operating voltage V	Version	Pack. pcs	Weight kg/100 pcs.	Item No.
<b>V25-B+C 3-280</b>	280	3-pole	1	42.500	<b>5094 42 3</b>

/pc.

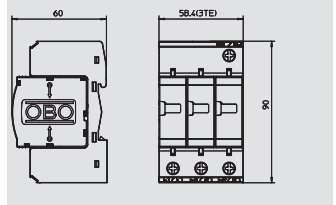

## Combination arrester, 4-pole

Type	Max. continuous operating voltage V	Version	Pack. pcs	Weight kg/100 pcs.	Item No.
<b>V25-B+C 4-280</b>	280	4-pole	1	53.000	<b>5094 42 6</b>

/pc.

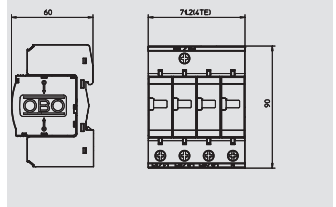

V25-B+C 1-280



V25-B+C 2-280

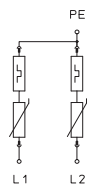

V25-B+C 3-280

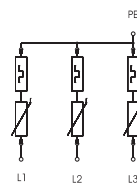

V25-B+C 4-280

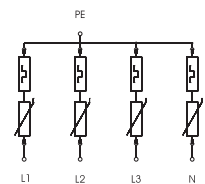

	$U_N$	V	230	230	230	230
Nominal voltage			230	230	230	230
SPD to EN 61643-11			Type 1+2	Type 1+2	Type 1+2	Type 1+2
SPD to IEC 61643-11			class I+II	class I+II	class I+II	class I+II
Lightning protection Zone LPZ			0-2	0-2	0-2	0-2
Impulse discharge current (10/350)	$I_{imp}$	kA	7	7	7	7
Total discharge current (10/350)	$I_{Total}$	kA	7	14	21	25
Nominal discharge current (8/20)	$I_n$	kA	30	30	30	30
Total discharge current (8/20)	$I_{Total}$	kA	30	60	90	120
Maximum discharge current	$I_{max}$	kA	50	50	50	50
Voltage protection level	$U_p$	kV	< 0,9	< 0,9	< 0,9	< 0,9
Response time	$t_A$	ns	< 25	< 25	< 25	< 25
Maximum back-up fuse		A	160	160	160	160
Temperature range	$\vartheta$	°C	-40 - +80	-40 - +80	-40 - +80	-40 - +80
Division unit TE (17.5 mm)			1	2	3	4
Degree of protection of enclosure			IP20	IP20	IP20	IP20
Connection cross-section, rigid		mm <sup>2</sup>	2,5 - 35	2,5 - 35	2,5 - 35	2,5 - 35
Connection cross-section, multi-wire		mm <sup>2</sup>	2,5 - 35	2,5 - 35	2,5 - 35	2,5 - 35
Connection cross-section, flexible		mm <sup>2</sup>	2,5 - 25	2,5 - 25	2,5 - 25	2,5 - 25
<b>Item No.</b>			<b>5094 41 8</b>	<b>5094 42 1</b>	<b>5094 42 3</b>	<b>5094 42 6</b>

# Combination arrester V25, 280 V with remote signalling

- Combination arrester, lightning current and surge arrester, type 1+2
- For lightning protection equipotential bonding to VDE 0185-305 (IEC 62305)
- Lightning current arresting capacity 7 kA (10/350) per pole and up to 25 kA (10/350) in total
- Arrester, plug-in, with dynamic cut-off unit and visual function display
- Encapsulated, non-extinguishing zinc oxide varistor arrester for use in distributor housings



Application: Building with outdoor line infeed or lightning risk.

## Combination arrester, 3-pole with remote signalling

Type	Max. continuous operating voltage V	Version	Pack. pcs	Weight kg/100 pcs.	Item No.
V25-B+C 3-FS280	280	3-pole with FS	1	42.700	5094 49 0

/pc.



## Combination arrester, 4-pole with remote signalling

Type	Max. continuous operating voltage V	Version	Pack. pcs	Weight kg/100 pcs.	Item No.
V25-B+C 4-FS280	280	4-pole with FS	1	53.200	5094 49 3

/pc.



## Combination arrester, 3-pole, with acoustic signalling

Type	Max. continuous operating voltage V	Version	Pack. pcs	Weight kg/100 pcs.	Item No.
V25-B+C 3+AS	280	3-pole	1	50.500	5097 18 5

/pc.



## Combination arrester, 4-pole, with acoustic signalling

Type	Max. continuous operating voltage V	Version	Pack. pcs	Weight kg/100 pcs.	Item No.
V25-B+C 4+AS280	280	4-pole	1	70.000	5097 19 3

/pc.



V25-B+C 3-FS280

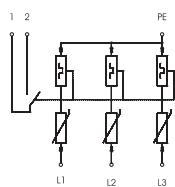

V25-B+C 4-FS280

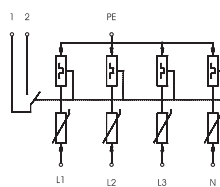

V25-B+C 3+AS

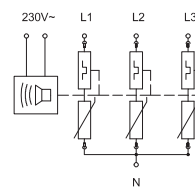

V25-B+C 4+AS280

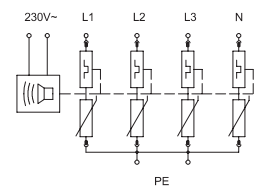

	$U_N$	V	230	230	230	230
Nominal voltage			230	230	230	230
SPD to EN 61643-11			Type 1+2	Type 1+2	Type 1+2	Type 1+2
SPD to IEC 61643-11			class I+II	class I+II	class I+II	class I+II
Lightning protection Zone LPZ			0-2	0-2	0-2	0-2
Impulse discharge current (10/350)	$I_{imp}$	kA	7	7	7	7
Total discharge current (10/350)	$I_{Total}$	kA	21	25	21	25
Nominal discharge current (8/20)	$I_n$	kA	30	30	30	30
Total discharge current (8/20)	$I_{Total}$	kA	90	120	90	120
Maximum discharge current	$I_{max}$	kA	50	50	50	50
Voltage protection level	$U_p$	kV	< 0,9	< 0,9	< 0,9	< 0,9
Response time	$t_A$	ns	< 25	< 25	< 25	< 25
Maximum back-up fuse	A	A	160	160	160	160
Temperature range	$\vartheta$	°C	-40 - +80	-40 - +80	-40 - +80	-40 - +80
Division unit TE (17,5 mm)			3	4	4	5
Degree of protection of enclosure			IP20	IP20	IP20	IP20
Connection cross-section, rigid	mm <sup>2</sup>		2,5 - 35	2,5 - 35	2,5 - 35	2,5 - 35
Connection cross-section, multi-wire	mm <sup>2</sup>		2,5 - 35	2,5 - 35	2,5 - 35	2,5 - 35
Connection cross-section, flexible	mm <sup>2</sup>		2,5 - 25	2,5 - 25	2,5 - 25	2,5 - 25
<b>Item No.</b>			<b>5094 49 0</b>	<b>5094 49 3</b>	<b>5097 18 5</b>	<b>5097 19 3</b>

# Combination arrester V25, 280 V



- Combination arrester, lightning current and surge arrester, type 1+2
- For lightning protection equipotential bonding to VDE 0185-305 (IEC 62305)
  - Lightning current arresting capacity 7 kA (10/350) per pole and up to 25 kA (10/350) in total
  - Arrester, plug-in, with dynamic cut-off unit and visual function display
  - Encapsulated, non-extinguishing zinc oxide varistor arrester for use in distributor housings

Application: Building with outdoor line infeed or lightning risk.

## Combination arrester, 4-pole, with voltage monitoring



Type	Max. continuous operating voltage V	Version	Pack. pcs	Weight kg/100 pcs.	Item No.
V25-B+C 4+FS-SÜ	280	4-pole	1	67.500	5097 35 5

/pc.

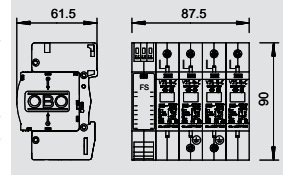

## Combination arrester, 4-pole in housing with remote signalling



Type	Max. continuous operating voltage V	Version	Pack. pcs	Weight kg/100 pcs.	Item No.
V25-B+C 4-FS-G	280	4-pole	1	127.000	5094 55 2

/pc.

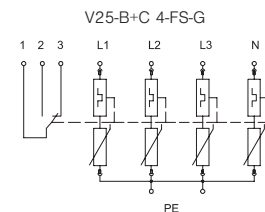
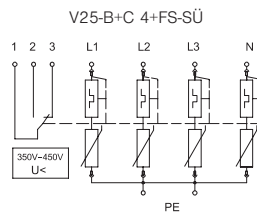
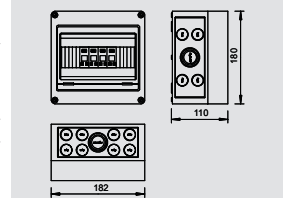

Nominal voltage	$U_N$	V	230	230
SPD to EN 61643-11			Type 1+2	Type 1+2
SPD to IEC 61643-11			class I+II	class I+II
Lightning protection Zone LPZ			0-2	0-2
Impulse discharge current (10/350)	$I_{imp}$	kA	7	7
Total discharge current (10/350)	$I_{Total}$	kA	25	25
Nominal discharge current (8/20)	$I_n$	kA	30	30
Total discharge current (8/20)	$I_{Total}$	kA	120	120
Maximum discharge current	$I_{max}$	kA	50	50
Voltage protection level	$U_p$	kV	< 0,9	< 0,9
Response time	$t_A$	ns	< 25	< 25
Maximum back-up fuse		A	160	160
Temperature range	$\vartheta$	°C	-40 - +80	-40 - +80
Division unit TE (17.5 mm)			5	2
Degree of protection of enclosure			IP20	IP65
Connection cross-section, rigid		mm <sup>2</sup>	2,5 - 35	2,5 - 35
Connection cross-section, multi-wire		mm <sup>2</sup>	2,5 - 35	2,5 - 35
Connection cross-section, flexible		mm <sup>2</sup>	2,5 - 25	2,5 - 25
Follow current interrupt rating	$I_c$	kA		
<b>Item No.</b>			<b>5097 35 5</b>	<b>5094 55 2</b>



# Combination arrester V25, 385 V for TN and TT network systems

- Combination arrester, lightning current and surge arrester, type 1+2
- For lightning protection equipotential bonding to VDE 0185-305 (IEC 62305)
  - Lightning current arresting capacity 7 kA (10/350) per pole and up to 25 kA (10/350) in total
  - Arrester, plug-in, with dynamic cut-off unit and visual function display
  - Encapsulated, non-extinguishing zinc oxide varistor arrester for use in distributor housings

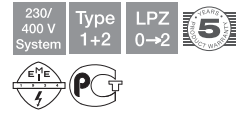

Application: Building with outdoor line infeed or lightning risk.

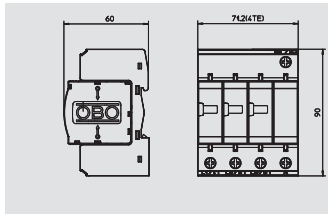

## Combination arrester, 3-pole + NPE

Type	Max. continuous operating voltage V	Version	Pack. pcs	Weight kg/100 pcs.	Item No.
<b>V25-B+C 3NPE385</b>	385	3-pole with NPE; 385 V	1	53.700	<b>5094 47 8</b>

/pc.

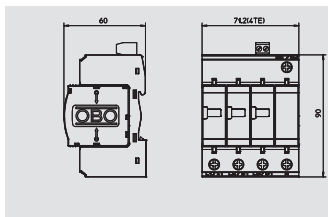

## Combination arrester, 3-pole + NPE with remote signalling

Type	Max. continuous operating voltage V	Version	Pack. pcs	Weight kg/100 pcs.	Item No.
<b>V25-B+C 3NPEFS38</b>	385	3 + NPE	1	51.000	<b>5094 52 6</b>

/pc.

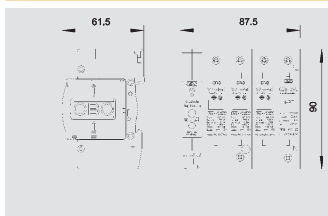

## Combination arrester, 3-pole + NPE, with acoustic signalling

Type	Max. continuous operating voltage V	Version	Pack. pcs	Weight kg/100 pcs.	Item No.
<b>V25-B+C 3NPEAS38</b>	385	3 + NPE	1	60.300	<b>5097 11 1</b>

/pc.



V25-B+C 3NPE385

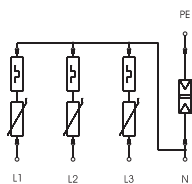

V25-B+C 3NPEFS38

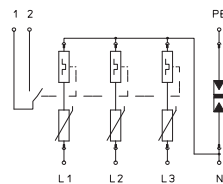

V25-B+C 3NPEAS38

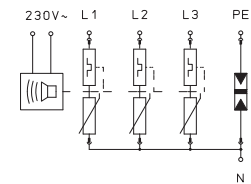

	U <sub>N</sub>	V	350	350	350
Nominal voltage			350	350	350
SPD to EN 61643-11			Type 1+2	Type 1+2	Type 1+2
SPD to IEC 61643-11			class I+II	class I+II	class I+II
Lightning protection Zone LPZ			0-2	0-2	0-2
Impulse discharge current (10/350)	I <sub>imp</sub>	kA	7	7	7
Total discharge current (10/350)	I <sub>Total</sub>	kA	25	25	25
Nominal discharge current (8/20)	I <sub>n</sub>	kA	30	30	30
Total discharge current (8/20)	I <sub>Total</sub>	kA	120	120	120
Maximum discharge current	I <sub>max</sub>	kA	50	50	50
Voltage protection level	U <sub>p</sub>	kV	< 1,5	< 1,5	< 1,5
Response time	t <sub>A</sub>	ns	< 25	< 25	< 25
Maximum back-up fuse	A	A	160	160	160
Temperature range	θ	°C	-40 - +80	-40 - +80	-40 - +80
Division unit TE (17,5 mm)			4	4	4
Degree of protection of enclosure			IP20	IP20	IP20
Connection cross-section, rigid	mm <sup>2</sup>		2,5 - 35	2,5 - 35	2,5 - 35
Connection cross-section, multi-wire	mm <sup>2</sup>		2,5 - 35	2,5 - 35	2,5 - 35
Connection cross-section, flexible	mm <sup>2</sup>		2,5 - 25	2,5 - 25	2,5 - 25
<b>Item No.</b>			<b>5094 47 8</b>	<b>5094 52 6</b>	<b>5097 11 1</b>



# Combination arrester V25, 385 V



- Combination arrester, lightning current and surge arrester, type 1+2
- For lightning protection equipotential bonding to VDE 0185-305 (IEC 62305)
  - Lightning current arresting capacity 7 kA (10/350) per pole and up to 25 kA (10/350) in total
  - Arrester, plug-in, with dynamic cut-off unit and visual function display
  - Encapsulated, non-extinguishing zinc oxide varistor arrester for use in distributor housings

Application: Building with outdoor line infeed or lightning risk.

## Combination arrester, 1-pole



Type	Max. continuous operating voltage V	Version	Pack. pcs	Weight kg/100 pcs.	Item No.
<b>V25-B+C 1-385</b>	385	1-pole complete	1	14.500	<b>5094 43 1</b>

/pc.

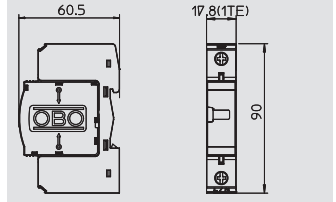

## Combination arrester, 2-pole



Type	Max. continuous operating voltage V	Version	Pack. pcs	Weight kg/100 pcs.	Item No.
<b>V25-B+C 2-385</b>	385	2-pole complete	1	27.500	<b>5094 43 4</b>

/pc.

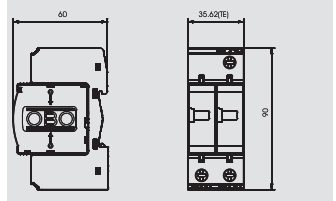

## Combination arrester, 3-pole



Type	Max. continuous operating voltage V	Version	Pack. pcs	Weight kg/100 pcs.	Item No.
<b>V25-B+C 3-385</b>	385	3-pole complete	1	42.000	<b>5094 43 7</b>

/pc.

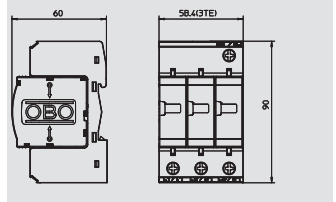

## Combination arrester, 4-pole



Type	Max. continuous operating voltage V	Version	Pack. pcs	Weight kg/100 pcs.	Item No.
<b>V25-B+C 4-385</b>	385	4-pole complete	1	51.000	<b>5094 44 0</b>

/pc.

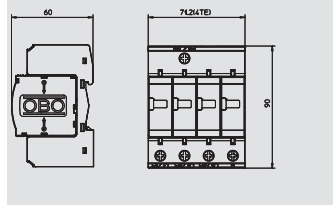

V25-B+C 1-385



V25-B+C 2-385

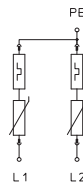

V25-B+C 3-385

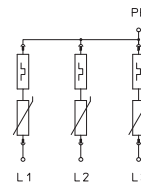

V25-B+C 4-385

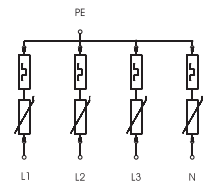

	$U_N$	V	350	350	350	350
Nominal voltage			350	350	350	350
SPD to EN 61643-11			Type 1+2	Type 1+2	Type 1+2	Type 1+2
SPD to IEC 61643-11			class I+II	class I+II	class I+II	class I+II
Lightning protection Zone LPZ			0-2	0-2	0-2	0-2
Impulse discharge current (10/350)	$I_{imp}$	kA	7	7	7	7
Total discharge current (10/350)	$I_{Total}$	kA	7	14	21	25
Nominal discharge current (8/20)	$I_n$	kA	30	30	30	30
Total discharge current (8/20)	$I_{Total}$	kA	30	60	90	120
Maximum discharge current	$I_{max}$	kA	50	50	50	50
Voltage protection level	$U_p$	kV	< 1,5	< 1,5	< 1,5	< 1,5
Response time	$t_A$	ns	< 25	< 25	< 25	< 25
Maximum back-up fuse		A	160	160	160	160
Temperature range	$\vartheta$	°C	-40 - +80	-40 - +80	-40 - +80	-40 - +80
Division unit TE (17.5 mm)			1	2	3	4
Degree of protection of enclosure			IP20	IP20	IP20	IP20
Connection cross-section, rigid		mm <sup>2</sup>	2,5 - 35	2,5 - 35	2,5 - 35	2,5 - 35
Connection cross-section, multi-wire		mm <sup>2</sup>	2,5 - 35	2,5 - 35	2,5 - 35	2,5 - 35
Connection cross-section, flexible		mm <sup>2</sup>	2,5 - 25	2,5 - 25	2,5 - 25	2,5 - 25
<b>Item No.</b>			<b>5094 43 1</b>	<b>5094 43 4</b>	<b>5094 43 7</b>	<b>5094 44 0</b>

# Accessories, upper parts and bases V25

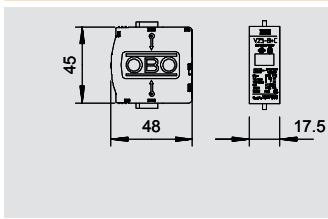

## Combination arrester upper part 150 V

Type	Max. continuous operating voltage V	U max DC V	Version	Pack. pcs	Weight kg/100 pcs.	Item No.
<b>V25-B+C 0-150</b>	150	200	1-pole	1	9.500	<b>5097 08 8</b>

/pc.

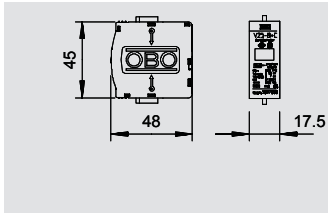

## Combination arrester upper part 280 V

Type	Max. continuous operating voltage V	U max DC V	Version	Pack. pcs	Weight kg/100 pcs.	Item No.
<b>V25-B+C 0-280</b>	280	350	1-pole	1	9.500	<b>5097 05 3</b>

/pc.

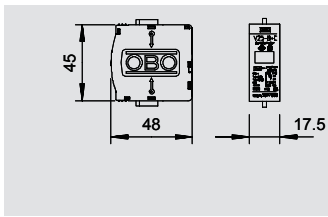

## Combination arrester upper part 320 V

Type	Max. continuous operating voltage V	U max DC V	Version	Pack. pcs	Weight kg/100 pcs.	Item No.
<b>V25-B+C 0-320</b>	320	420	1-pole	100	10.000	<b>5097 29 0</b>

/pc.

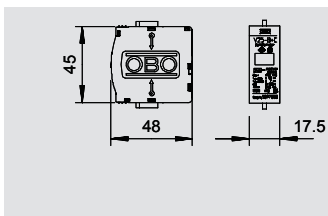

## Combination arrester upper part 385 V

Type	Max. continuous operating voltage V	U max DC V	Version	Pack. pcs	Weight kg/100 pcs.	Item No.
<b>V25-B+C 0-385</b>	385	505	1-pole	1	9.500	<b>5097 06 1</b>

/pc.



V25-B+C 0-150

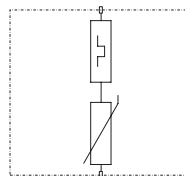

V25-B+C 0-280

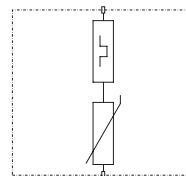

V25-B+C 0-320

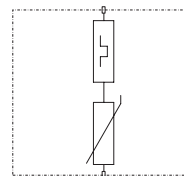

V25-B+C 0-385

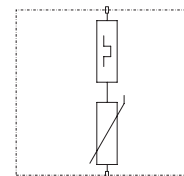

	$U_N$	V	130	230	320	350
Nominal voltage			130	230	320	350
SPD to EN 61643-11			Type 1+2	Type 1+2	Type 1+2	Type 1+2
SPD to IEC 61643-11			class I+II	class I+II	class I+II	class I+II
Lightning protection Zone LPZ			0-2	0-2	0-2	0-2
Impulse discharge current (10/350)	$I_{imp}$	kA	8	7	7	7
Total discharge current (10/350)	$I_{Total}$	kA	8	7	7	7
Nominal discharge current (8/20)	$I_n$	kA	30	30	30	30
Total discharge current (8/20)	$I_{Total}$	kA	30	30	30	30
Maximum discharge current	$I_p$	kA	50	50	50	50
Voltage protection level	$U_p$	kV	< 0,6	< 0,9	< 1,3	< 1,5
Response time	$t_A$	ns	< 25	< 25	< 25	< 25
Maximum back-up fuse		A	160	160	160	160
Temperature range	$\vartheta$	°C	-40 - +80	-40 - +80	-40 - +80	-40 - +80
Division unit TE (17,5 mm)			1	1	1	1
Degree of protection of enclosure			IP20	IP20	IP20	IP20
<b>Item No.</b>			<b>5097 08 8</b>	<b>5097 05 3</b>	<b>5097 29 0</b>	<b>5097 06 1</b>



## Accessories, upper parts and bases V25



### Shock Guard for Multibase base

Type	Colour	Version	Pack.	Weight	Item No.
<b>MB-SG</b>	Blue	Locking system for upper parts	100	0.060 kg/100 pcs.	<b>5096 69 5</b>
PA Polyamide					/pc.

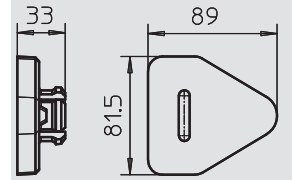

### Connecting bridge, Multibase base

Type	Version	Pack.	Weight	Item No.
<b>VB-MULTIBASE250</b>	4-pole	1	6.800 kg/100 pcs.	<b>5089 65 5</b>
/pc.				

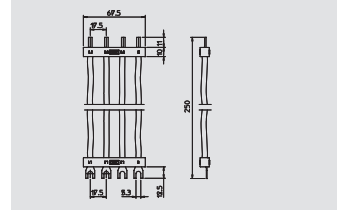

### Empty housing for arrestors

Type	Pack.	Weight	Item No.
<b>VG LM</b>	1	139.100 kg/100 pcs.	<b>5088 87 9</b>
PA Polyamide			
/pc.			

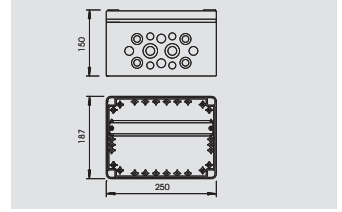

### Upper part total spark gap between N and PE 255 V

Type	Max. continuous operating voltage V	Version	Pack.	Weight	Item No.
<b>C 25-B+C 0</b>	255	NPE	1	5.200 kg/100 pcs.	<b>5095 60 3</b>
/pc.					

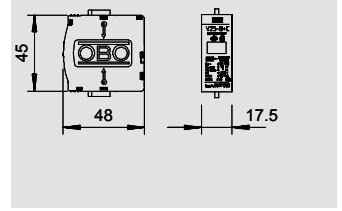

### Remote signalling replacement connector for Multibase

Type	Version	Pack.	Weight	Item No.
<b>MB-FS</b>	2-pole	25	0.310 kg/100 pcs.	<b>5096 69 3</b>
/pc.				

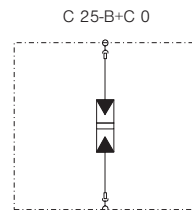
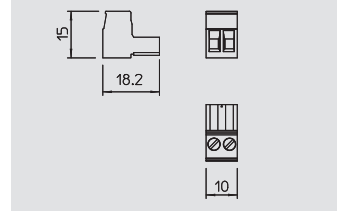

Nominal voltage	$U_N$	V	230
SPD to EN 61643-11			Type 1+2
SPD to IEC 61643-11			class I-II
Lightning protection Zone LPZ			0-2
Lightning impulse current (10/350) (N-PE)	$I_{imp}$	kA	25
Nominal discharge current (8/20)	$I_n$	kA	30
Maximum discharge current	$I_{max}$	kA	50
Voltage protection level	$U_p$	kV	<1,2
Response time	$t_A$	ns	< 100
Follow current interrupt rating	$I_{fi}$	kA	0.1
Maximum back-up fuse		A	160
Temperature range	$\vartheta$	°C	-40 - +80
Division unit TE (17.5 mm)			1
Degree of protection of enclosure			IP20
Connection cross-section, rigid		mm <sup>2</sup>	2,5 - 35
Connection cross-section, multi-wire		mm <sup>2</sup>	2,5 - 35
Connection cross-section, flexible		mm <sup>2</sup>	2,5 - 25
<b>Item No.</b>			<b>5095 60 3</b>

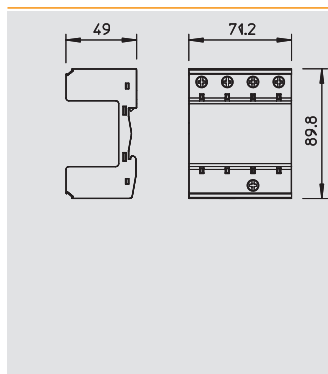

## Base, Multibase



Type	Version	Dividing unit TE (17.5 mm)	Pack.	Weight	Item No.
			pcs	kg/100 pcs.	
<b>MB 1</b>	1-pole	1	1	6.200	<b>5096 64 8</b>
<b>MB 2</b>	2-pole	2	1	11.200	<b>5096 65 3</b>
<b>MB 3</b>	3-pole	3	1	16.000	<b>5096 66 5</b>
<b>MB 4</b>	4-pole	4	1	21.000	<b>5096 68 0</b>



/pc.

- Suitable for V25-B+C, V20-C and V10-C
- Pre-mounted and ready for connection
- For TN systems
- Multifunction terminals for easy circuit of series-mounted devices
- Upper parts can be rotated through 180 degrees

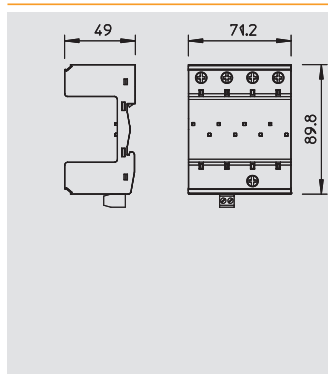

## Base, Multibase with remote signalling



Type	Version	Dividing unit TE (17.5 mm)	Pack.	Weight	Item No.
			pcs	kg/100 pcs.	
<b>MB 1+FS</b>	1-pole	1	1	6.700	<b>5096 64 9</b>
<b>MB 2+FS</b>	2-pole	2	1	11.700	<b>5096 65 4</b>
<b>MB 3+FS</b>	3-pole	3	1	16.500	<b>5096 66 7</b>
<b>MB 4+FS</b>	4-pole	4	1	21.000	<b>5096 68 2</b>



/pc.

- Suitable for V 25-B+C, V 20-C and V10-C
- Pre-mounted and ready for connection
- Multifunction terminals for easy connection to series-mounted devices
- Upper parts can be rotated through 180 degrees
- With remote signalling, potential-free NO contact, for function monitoring

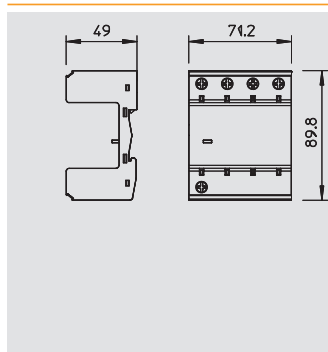

## Base, Multibase + NPE



Type	Version	Dividing unit TE (17.5 mm)	Pack.	Weight	Item No.
			pcs	kg/100 pcs.	
<b>MB 1+NPE</b>	1 + NPE	2	1	11.500	<b>5096 65 0</b>
<b>MB 2+NPE</b>	2 + NPE	3	1	16.100	<b>5096 65 5</b>
<b>MB 3+NPE</b>	3 + NPE	4	1	20.000	<b>5096 66 9</b>



/pc.

- Suitable for V 25-B+C, V 20-C and V10-C
- Pre-mounted and ready for connection
- Multifunction terminals for easy connection to series-mounted devices
- Upper parts can be rotated through 180 degrees
- For TN-S and TT network systems

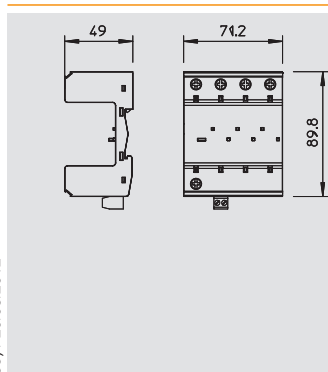

## Base, Multibase + NPE with remote signalling



Type	Version	Dividing unit TE (17.5 mm)	Pack.	Weight	Item No.
			pcs	kg/100 pcs.	
<b>MB 1+NPE+FS</b>	1 + NPE	2	1	11.600	<b>5096 65 1</b>
<b>MB 2+NPE+FS</b>	2 + NPE	3	1	16.000	<b>5096 65 7</b>
<b>MB 3+NPE+FS</b>	3 + NPE	4	1	21.300	<b>5096 67 1</b>



/pc.

- Suitable for V 25-B+C, V 20-C and V10-C
- Pre-mounted and ready for connection
- Multifunction terminals for easy connection to series-mounted devices
- Upper parts can be rotated through 180 degrees
- With remote signalling, potential-free NO contact, for function monitoring
- 3+1 protection circuit for TN-S and TT network systems

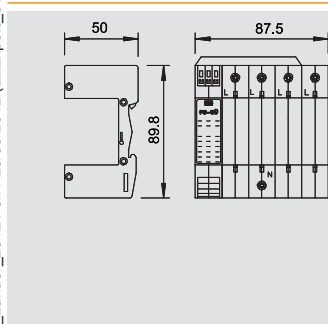

## Base, Multibase with fuse monitoring



Type	Version	Pack.	Weight	Item No.
		pcs	kg/100 pcs.	
<b>V20-C U-3 FS-SU</b>	3-pole	1	26.000	<b>5096 35 9</b>
<b>V20-C U-4 FS-SU</b>	4-pole	1	33.000	<b>5096 36 7</b>



/pc.

- Suitable for V 25-B+C, V 20-C and V 10-C
- With voltage monitoring of phases and function monitoring of arrester upper part, remote signalling
- With remote signaling, potential-free changeover contact, for function monitoring
- Pre-mounted and ready for connection

## Accessories, upper parts and bases V25



### Base, Multibase with acoustic signalling

Type	Version	Pack.	Weight	Item No.
		pcs	kg/100 pcs.	
<b>V20-C U-2 AS</b>	2-pole	1	23.000	<b>5096 41 3</b>
<b>V20-C U-3 AS</b>	3-pole	1	29.000	<b>5096 42 1</b>
<b>V20-C U-4 AS</b>	4-pole	1	35.000	<b>5096 44 8</b>
<b>V20-C U-3+NPE-AS</b>	3 + NPE	1	32.500	<b>5096 37 2</b>

/pc.

- Suitable for V 25-B+C, V 20-C and V 10-C
- With remote signaling, potential-free changeover contact, for function monitoring
- With acoustic signalling for function monitoring, signal tone can be shut down for 24 h
- Pre-mounted and ready for connection

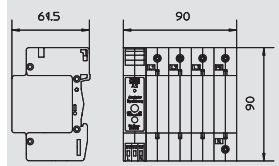

### Base, Multibase + NPE with fuse monitoring

Type	Version	Pack.	Weight	Item No.
		pcs	kg/100 pcs.	
<b>V20-C U-3+NPE</b>	3-NPE with FS-SÜ	1	30.000	<b>5096 37 0</b>

/pc.

- Suitable for V 25-B+C, V 20-C and V 10-C
- With voltage monitoring of phases and function monitoring of arrester upper part, remote signalling
- With remote signalling, potential-free changeover contact, for function monitoring
- For TN-S and TT network systems
- Pre-mounted and ready for connection

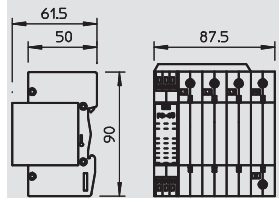

# Combination arrester, protection set for TN and TT network systems

Protection set, lightning and surge arrester combination, Type 1+2

- For lightning protection equipotential bonding to VDE 0185-305 (IEC 62305)
- Lightning current arresting capacity to 50 kA (10/350) per pole and up to 125 kA (10/350) N-PE
- Arrester, connectable, including connecting bridges, labelled connection terminals
- Encapsulated, non-extinguishing arrester for use in distributor housings

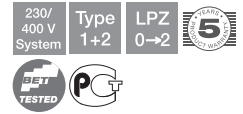

Application: Mobile telecommunications systems and industrial systems with special requirements.

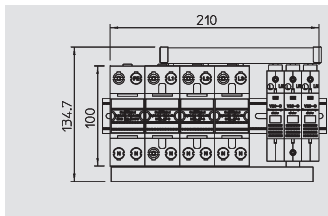

## Protection set MCD + V20 3-pole + NPE

Type	Max. continuous operating voltage V	Version	Pack. pcs	Weight kg/100 pcs.	Item No.
<b>PS4-B+C TT+TNS</b>	255	3 + NPE	1	206.000	<b>5089 76 1</b>

/pc.

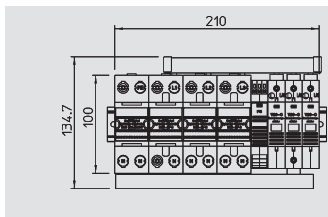

## Protection set MCD + V20 3-pole + NPE with remote signalling

Type	Max. continuous operating voltage V	Version	Pack. pcs	Weight kg/100 pcs.	Item No.
<b>PS4-B+C TNS+FS</b>	255	3 + NPE	1	211.000	<b>5089 76 3</b>

/pc.

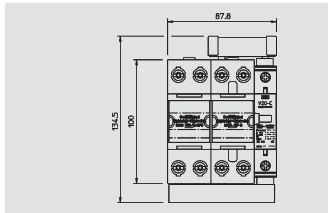

## Protection set MCD + V20 1-pole + NPE

Type	Max. continuous operating voltage V	Version	Pack. pcs	Weight kg/100 pcs.	Item No.
<b>PS 2-B+C/TT+TNS</b>	255	1 + NPE	1	101.000	<b>5089 74 8</b>

/pc.

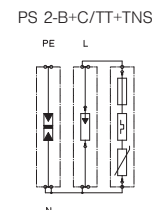
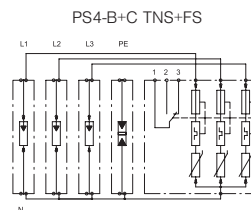
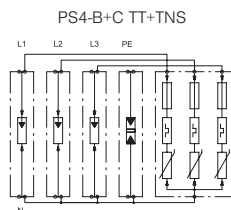

	$U_N$	V	230	230	230
Nominal voltage			230	230	230
SPD to EN 61643-11			Type 1+2	Type 1+2	Type 1+2
SPD to IEC 61643-11			class I+II	class I+II	class I+II
Lightning protection Zone LPZ			0-2	0-2	0-2
Impulse discharge current (10/350)	$I_{imp}$	kA	100	100	100
Total discharge current (10/350)	$I_{Total}$	kA	100	100	100
Nominal discharge current (8/20)	$I_n$	kA	100	100	100
Total discharge current (8/20)	$I_{Total}$	kA	100	100	100
Maximum discharge current	$I_{max}$	kA	100	100	100
Voltage protection level	$U_p$	kV	<1,3	<1,3	<1,3
Response time	$t_A$	ns	<25	<25	<25
Follow current interrupt rating	$I_{li}$	kA	25	25	25
Maximum back-up fuse		A	125	125	125
Temperature range	$\vartheta$	°C	-40 - +85	-40 - +85	-40 - +85
Division unit TE (17,5 mm)			12	11	5
Degree of protection of enclosure			IP20	IP20	IP20
Connection cross-section, rigid		mm <sup>2</sup>	10 - 50	10 - 50	10 - 50
Connection cross-section, multi-wire		mm <sup>2</sup>	10 - 35	10 - 35	10 - 35
Connection cross-section, flexible		mm <sup>2</sup>	10 - 25	10 - 25	10 - 25
<b>Item No.</b>			<b>5089 76 1</b>	<b>5089 76 3</b>	<b>5089 74 8</b>

Always indicate the item number when ordering.

# Combination arrester, protection set for TN-C network systems

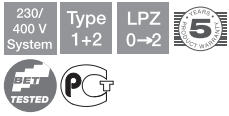

Protection set, lightning and surge arrester combination, Type 1+2

- For lightning protection equipotential bonding to VDE 0185-305 (IEC 62305)
- Lightning current arresting capacity to 50 kA (10/350) per pole and up to 125 kA (10/350) N-PE
- Arrester, connectable, including connecting bridges, labelled connection terminals
- Encapsulated, non-extinguishing arrester for use in distributor housings

Application: Mobile telecommunications systems and industrial systems with special requirements.



## Protection set MCD + V20 3-pole

Type	Max. continuous operating voltage V	Version	Pack. pcs	Weight kg/100 pcs.	Item No.
<b>PS3-B+C TNC</b>	255	3-pole	1	158.000	<b>5089 75 4</b>
<b>PS3-B+C-320</b>	320	3-pole	1	160.000	<b>5089 75 5</b>

/pc.

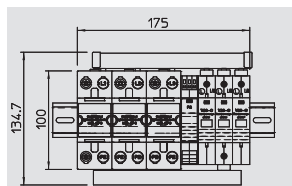

## Protection set MCD + V20 3-pole with remote signalling

Type	Max. continuous operating voltage V	Version	Pack. pcs	Weight kg/100 pcs.	Item No.
<b>PS3-B+C TNC+FS</b>	255	3-pole	1	163.000	<b>5089 75 6</b>

/pc.

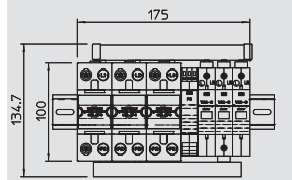

## Protection set MCD + V20 3-pole with remote signalling

Type	Max. continuous operating voltage V	Version	Pack. pcs	Weight kg/100 pcs.	Item No.
<b>PS3-B+C-320+FS</b>	320	3-pole	1	170.000	<b>5089 75 7</b>

/pc.

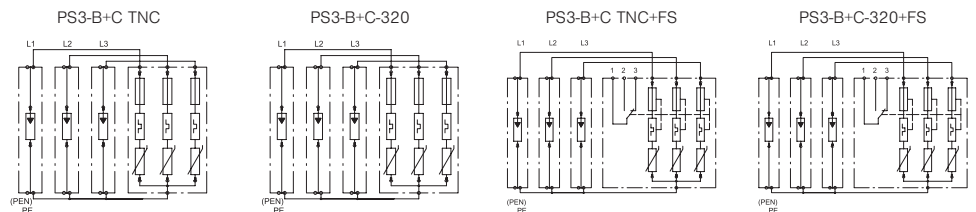
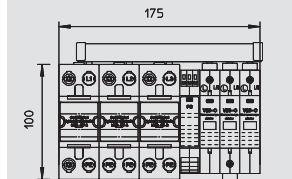

Nominal voltage	$U_N$	V	230	320	230	320
SPD to EN 61643-11			Type 1+2	Type 1+2	Type 1+2	Type 1+2
SPD to IEC 61643-11			class I+II	class I+II	class I+II	class I+II
Lightning protection Zone LPZ			0-2	0-2	0-2	0-2
Impulse discharge current (10/350)	$I_{imp}$	kA	100	100	100	100
Total discharge current (10/350)	$I_{Total}$	kA	100	100	100	100
Nominal discharge current (8/20)	$I_n$	kA	100	100	100	100
Total discharge current (8/20)	$I_{Total}$	kA	100	100	100	100
Maximum discharge current	$I_{max}$	kA	100	100	100	100
Voltage protection level	$U_p$	kV	< 1,3	< 1,7	< 1,3	< 1,7
Response time	$t_A$	ns	< 25	< 25	< 25	< 25
Follow current interrupt rating	$I_{fi}$	kA	25	25	25	25
Maximum back-up fuse		A	125	125	125	125
Temperature range	$\vartheta$	°C	-40 - +85	-40 - +85	-40 - +85	-40 - +85
Division unit TE (17.5 mm)			10	10	10	10
Degree of protection of enclosure			IP20	IP20	IP20	IP20
Connection cross-section, rigid		mm <sup>2</sup>	10 - 50	10 - 50	10 - 50	10 - 50
Connection cross-section, multi-wire		mm <sup>2</sup>	10 - 35	10 - 35	10 - 35	10 - 35
Connection cross-section, flexible		mm <sup>2</sup>	10 - 25	10 - 25	10 - 25	10 - 25
<b>Item No.</b>			<b>5089 75 4</b>	<b>5089 75 5</b>	<b>5089 75 6</b>	<b>5089 75 7</b>



# Combination arrester, protection set VA for TN and TT network systems

Protection set VA, lightning and surge arrester combination, Type 1+2

- For lightning protection equipotential bonding to VDE 0185-305 (IEC 62305)
- Lightning current arresting capacity to 50 kA (10/350) per pole and up to 125 kA (10/350) N-PE
- Free of leak current and suitable for use in pre-meter area according to the VDEW directive
- Arrester, connectable, including connecting bridges, labelled connection terminals
- Encapsulated, non-extinguishing arrester for use in distributor housings

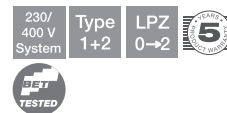

Application: pre-meter area and industrial systems with special requirements.

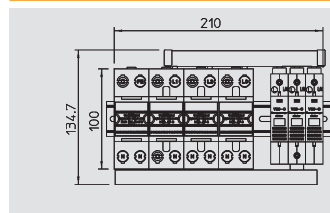

## Protection set MCD + V20, leakage current-free, 3-pole + NPE

Type	Max. continuous operating voltage V	Version	Pack. pcs	Weight kg/100 pcs.	Item No.
<b>PS4-VA TT+TNS</b>	255	3 + NPE	1	210.000	<b>5089 77 0</b>



/pc.

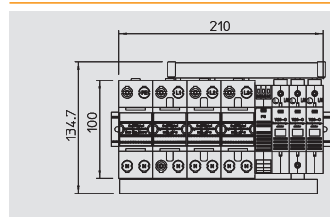

## Protection set MCD + V20, leakage current-free, 3-pole + NPE with remote signalling

Type	Max. continuous operating voltage V	Version	Pack. pcs	Weight kg/100 pcs.	Item No.
<b>PS4-VA TT+FS</b>	255	3 + NPE	1	215.000	<b>5089 77 7</b>



/pc.

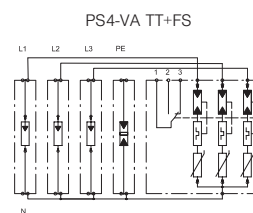
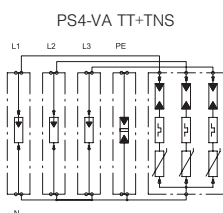



Nominal voltage	$U_N$	V	230	230
SPD to EN 61643-11			Type 1+2	Type 1+2
SPD to IEC 61643-11			class I	class I
Lightning protection Zone LPZ			0→2	0→2
Impulse discharge current (10/350)	$I_{imp}$	kA	100	100
Total discharge current (10/350)	$I_{Total}$	kA	100	100
Nominal discharge current (8/20)	$I_n$	kA	100	100
Total discharge current (8/20)	$I_{Total}$	kA	100	100
Maximum discharge current	$I_{max}$	kA	100	100
Voltage protection level	$U_p$	kV	<1,3	<1,3
Response time	$t_A$	ns	<25	<25
Follow current interrupt rating	$I_{li}$	kA	25	25
Maximum back-up fuse		A	125	125
Temperature range	$\vartheta$	°C	-40 - +85	-40 - +85
Division unit TE (17,5 mm)			12	12
Degree of protection of enclosure			IP20	IP20
Connection cross-section, rigid		mm <sup>2</sup>	10 - 50	10 - 50
Connection cross-section, multi-wire		mm <sup>2</sup>	10 - 35	10 - 35
Connection cross-section, flexible		mm <sup>2</sup>	10 - 25	10 - 25
<b>Item No.</b>			<b>5089 77 0</b>	<b>5089 77 7</b>

Surge protection, arrester, type 1+2 (office and housing)



# Combination arrester, protection set VA for TN-C network systems

230/400 V System  
 Type 1+2  
 LPZ 0→2  
  

Protection set VA, lightning and surge arrester combination, Type 1+2

- For lightning protection equipotential bonding to VDE 0185-305 (IEC 62305)
- Lightning current arresting capacity to 50 kA (10/350) per pole and up to 125 kA (10/350) N-PE
- Free of leak current and suitable for use in pre-meter area according to the VDEW directive
- Arrester, connectable, including connecting bridges, labelled connection terminals
- Encapsulated, non-extinguishing arrester for use in distributor housings

Application: pre-meter area and industrial systems with special requirements.



### Protection set MCD + V20, leakage current-free, 3-pole

Type	Max. continuous operating voltage V	Version	Pack. pcs	Weight kg/100 pcs.	Item No.
<b>PS3-VA TNC</b>	255	3-pole	1	162.000	<b>5089 76 8</b>

/pc.

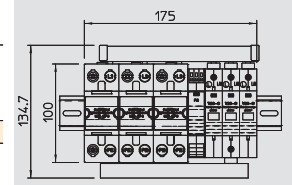

### Protection set MCD + V20, leakage current-free, 3-pole with remote signalling

Type	Max. continuous operating voltage V	Version	Pack. pcs	Weight kg/100 pcs.	Item No.
<b>PS3-VA TNC+FS</b>	255	3-pole	1	167.000	<b>5089 77 5</b>

/pc.

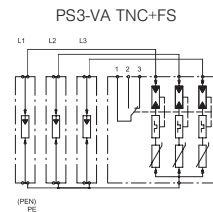
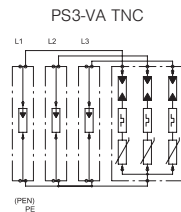
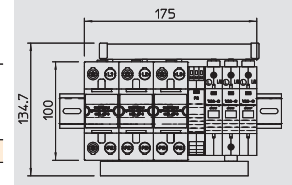

Nominal voltage	$U_N$	V	230	230
SPD to EN 61643-11			Type 1+2	Type 1+2
SPD to IEC 61643-11			class I	class I
Lightning protection Zone LPZ			0→2	0→2
Impulse discharge current (10/350)	$I_{imp}$	kA	100	100
Total discharge current (10/350)	$I_{Total}$	kA	100	100
Nominal discharge current (8/20)	$I_n$	kA	100	100
Total discharge current (8/20)	$I_{Total}$	kA	100	100
Maximum discharge current	$I_{max}$	kA	100	100
Voltage protection level	$U_p$	kV	<1,3	<1,3
Response time	$t_A$	ns	<25	<25
Follow current interrupt rating	$I_{fi}$	kA	25	25
Maximum back-up fuse		A	125	125
Temperature range	$\vartheta$	°C	-40 - +85	-40 - +85
Division unit TE (17.5 mm)			10	10
Degree of protection of enclosure			IP20	IP20
Connection cross-section, rigid		mm <sup>2</sup>	10 - 50	10 - 50
Connection cross-section, multi-wire		mm <sup>2</sup>	10 - 35	10 - 35
Connection cross-section, flexible		mm <sup>2</sup>	10 - 25	10 - 25
<b>Item No.</b>			<b>5089 76 8</b>	<b>5089 77 5</b>

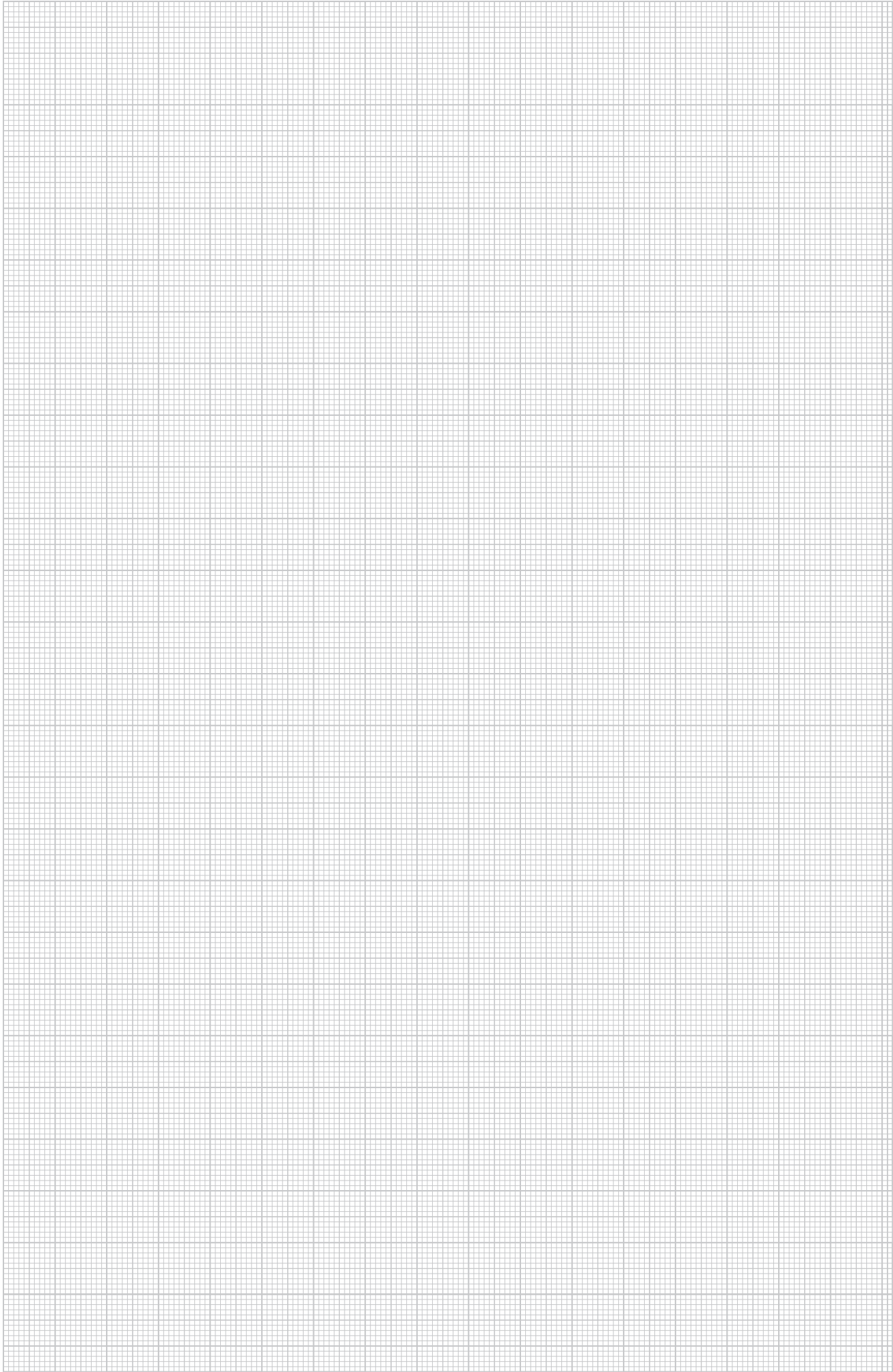











Bitte beachten Sie die  
Stromspannungswerte  
gegen Erdpotential.

**OBO**  
STYERMARK

Bei Vorkaufsanforderungen bitte an OBO 0800  
oder 020 2 8400 10000 anrufen bzw. schreiben.  
www.obo.com

System includes surge-protective devices.  
Please observe in accordance with OBO signs in  
OEM devices, protection being implemented.

## Surge protection energy technology, arrester, Type 2

	Surge arrester	V20, 150 V for TN and TT networks	176
		V20, 150 V for TN networks	177
		V20, 280 V for TN and TT networks	179
		V20, 280 V for TN networks	181
		V20, 385 V for TN and TT networks	185
		V20, 385 V for TN networks	186
		V20, 550 V for TN networks	188
		V20, leak current-free version	192
	Accessories, upper parts and bases V20		193





## Surge protection energy technology: the plus of the V20-C family

- + Connectable surge arrester
- + High arresting capacity
- + Visual status display
- + Available with optional remote signalling
- + Optional leak current-free version
- + Vibration-proof through Shock Guard
- + Simple standard hat rail mounting
- + Labelled connections



### Function and areas of use

The surge arrestors V20 meet the type 2 requirement class according to IEC 61643-11. These devices protect low voltage consumer systems from overvoltages of all types, and are available in

single-pole to four-pole versions. The voltage-limiting high-performance zinc oxide varistor provides several benefits. An extremely short response time, a low protection level and high current leakage capability with long service life. In

addition, the devices do not produce any line follow current. If circumstances are uncertain and there is a risk of fire from overloads, the cut-off unit disconnects the arrester safely from the mains.



# Surge arrester V20, 150 V for TN and TT networks



Surge arrester, type 2, 150 V

- VDE-tested
- For surge voltage protection equipotential bonding to VDE 0100-443 (IEC 60364-4-44)
- Arresting capacity to 40 kA (8/20) per pin
- Arrester, connectable with dynamic cut-off unit and visual function display
- Encapsulated, non-extinguishing zinc oxide varistor arrester for use in distributor housings
- Base with multiple connection terminals

Application: Equipotential bonding (LPZ 1 to 2) and device protection in main and subdistributors.

## Surge arrester, 1-pole + NPE



Type	Max. continuous operating voltage V	Version	Pack. pcs	Weight kg/100 pcs.	Item No.
<b>V20-C 1+NPE-150</b>	150	1 + NPE	1	21.500	<b>5094 63 9</b>

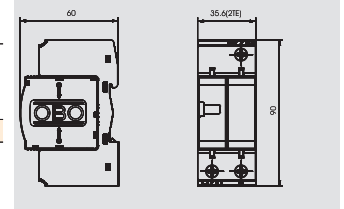

/pc.

## Surge arrester, 2-pole + NPE



Type	Max. continuous operating voltage V	Version	Pack. pcs	Weight kg/100 pcs.	Item No.
<b>V20-C 2+NPE-150</b>	150	2 + NPE	1	32.000	<b>5094 64 1</b>

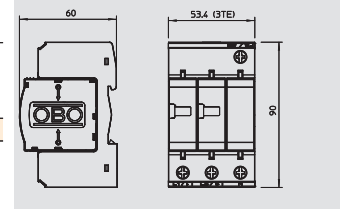

/pc.

## Surge arrester, 3-pole + NPE



Type	Max. continuous operating voltage V	Version	Pack. pcs	Weight kg/100 pcs.	Item No.
<b>V20-C 3+NPE-150</b>	150	3 + NPE	1	39.600	<b>5094 64 4</b>

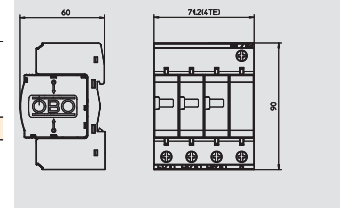

/pc.

V20-C 1+NPE-150

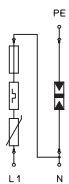

V20-C 2+NPE-150

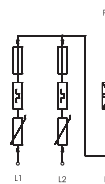

V20-C 3+NPE-150

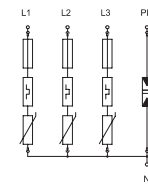

Nominal voltage	$U_N$	V	130	130	130
SPD to EN 61643-11			Type 2	Type 2	Type 2
SPD to IEC 61643-11			class II	class II	class II
Lightning protection Zone LPZ			1→2	1→2	1→2
Nominal discharge current (8/20)	$I_n$	kA	20	20	20
Total discharge current (8/20)	$I_{Total}$	kA	40	60	80
Maximum discharge current	$I_{max}$	kA	40	40	40
Voltage protection level	$U_p$	kV	< 0,8	< 0,8	< 0,8
Response time	$t_A$	ns	< 25	< 25	< 25
Maximum back-up fuse		A	125	125	125
Temperature range	$\vartheta$	°C	-40 - +80	-40 - +80	-40 - +80
Division unit TE (17.5 mm)			2	3	4
Degree of protection of enclosure			IP20	IP20	IP20
Connection cross-section, rigid		mm <sup>2</sup>	2,5 - 35	2,5 - 35	2,5 - 35
Connection cross-section, multi-wire		mm <sup>2</sup>	2,5 - 35	2,5 - 35	2,5 - 35
Connection cross-section, flexible		mm <sup>2</sup>	2,5 - 25	2,5 - 25	2,5 - 25
<b>Item No.</b>			<b>5094 63 9</b>	<b>5094 64 1</b>	<b>5094 64 4</b>





# Surge arrester V20, 150 V for TN and TT networks

Surge arrester, type 2, 150 V

- VDE-tested
  - For surge voltage protection equipotential bonding to VDE 0100-443 (IEC 60364-4-44)
  - Arresting capacity to 40 kA (8/20) per pin
  - Arrester, connectable with dynamic cut-off unit and visual function display
  - Encapsulated, non-extinguishing zinc oxide varistor arrester for use in distributor housings
  - Base with multiple connection terminals
- Application: Equipotential bonding (LPZ 1 to 2) and device protection in main and subdistributors.

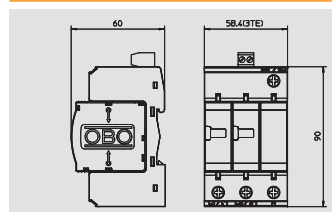

## Surge arrester, 2-pole + NPE with remote signalling

Type	Max. continuous operating voltage V	Version	Pack. pcs	Weight kg/100 pcs.	Item No.
<b>V20-C 2+NPEFS15</b>	150	2 + NPE	1	32.200	<b>5094 75 0</b>

/pc.

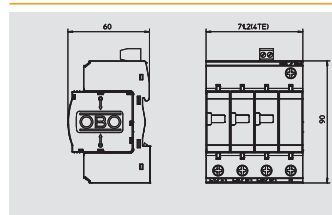

## Surge arrester, 3-pole + NPE with remote signalling

Type	Max. continuous operating voltage V	Version	Pack. pcs	Weight kg/100 pcs.	Item No.
<b>V 20-C 3+NPE+FS</b>	150	3 + NPE	1	41.300	<b>5094 76 4</b>

/pc.



Surge protection, arrester, type 2



V20-C 2+NPEFS15

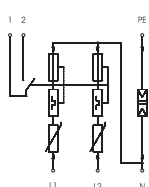

V 20-C 3+NPE+FS

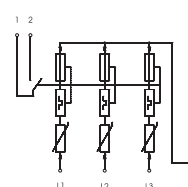

Nominal voltage	$U_N$	V	130	130
SPD to EN 61643-11			Type 2	Type 2
SPD to IEC 61643-11			class II	class II
Lightning protection Zone LPZ			1→2	1→2
Nominal discharge current (8/20)	$I_n$	kA	20	20
Total discharge current (8/20)	$I_{Total}$	kA	60	80
Maximum discharge current	$I_{max}$	kA	40	40
Voltage protection level	$U_p$	kV	< 0,8	< 0,8
Response time	$t_A$	ns	< 25	< 25
Maximum back-up fuse		A	125	125
Temperature range	$\vartheta$	°C	-40 - +80	-40 - +80
Division unit TE (17,5 mm)			3	4
Degree of protection of enclosure			IP20	IP20
Connection cross-section, rigid		mm <sup>2</sup>	2,5 - 35	2,5 - 35
Connection cross-section, multi-wire		mm <sup>2</sup>	2,5 - 35	2,5 - 35
Connection cross-section, flexible		mm <sup>2</sup>	2,5 - 25	2,5 - 25
<b>Item No.</b>			<b>5094 75 0</b>	<b>5094 76 4</b>

# Surge arrester V20, 150 V for TN networks



Surge arrester, type 2, 150 V

- VDE-tested
  - For surge voltage protection equipotential bonding to VDE 0100-443 (IEC 60364-4-44)
  - Arresting capacity to 40 kA (8/20) per pin
  - Arrester, connectable with dynamic cut-off unit and visual function display
  - Encapsulated, non-extinguishing zinc oxide varistor arrester for use in distributor housings
  - Base with multiple connection terminals
- Application: Equipotential bonding (LPZ 1 to 2) and device protection in main and subdistributors.

## Surge arrester, 1-pole



Type	Max. continuous operating voltage V	Version	Pack. pcs	Weight kg/100 pcs.	Item No.
<b>V20-C 1-150</b>	150	1-pole	1	11.300	<b>5094 67 7</b>

/pc.

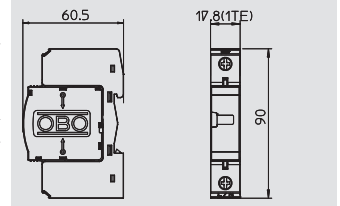

## Surge arrester, 2-pole



Type	Max. continuous operating voltage V	Version	Pack. pcs	Weight kg/100 pcs.	Item No.
<b>V20-C 2-150</b>	150	2-pole	1	21.300	<b>5094 67 9</b>

/pc.

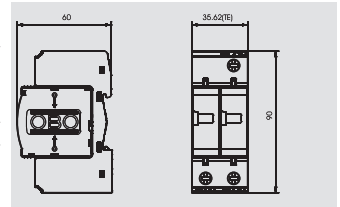

## Surge arrester, 3-pole



Type	Max. continuous operating voltage V	Version	Pack. pcs	Weight kg/100 pcs.	Item No.
<b>V20-C 3-150</b>	150	3-pole	1	31.500	<b>5094 68 0</b>

/pc.

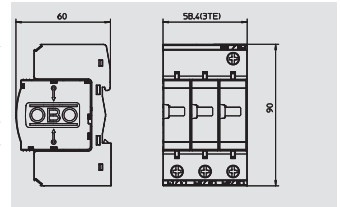

V20-C 1-150



V20-C 2-150



V20-C 3-150

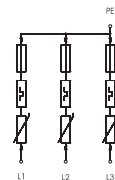

	U <sub>N</sub>	V	130	130	130
Nominal voltage					
SPD to EN 61643-11			Type 2	Type 2	Type 2
SPD to IEC 61643-11			class II	class II	class II
Lightning protection Zone LPZ			1→2	1→2	1→2
Nominal discharge current (8/20)	I <sub>n</sub>	kA	20	20	20
Total discharge current (8/20)	I <sub>Total</sub>	kA	20	40	60
Maximum discharge current	I <sub>max</sub>	kA	40	40	40
Voltage protection level	U <sub>p</sub>	kV	< 0,8	< 0,8	< 0,8
Response time	t <sub>A</sub>	ns	< 25	< 25	< 25
Maximum back-up fuse		A	125	125	125
Temperature range	θ	°C	-40 - +80	-40 - +80	-40 - +80
Division unit TE (17.5 mm)			1	2	3
Degree of protection of enclosure			IP20	IP20	IP20
Connection cross-section, rigid		mm <sup>2</sup>	2,5 - 35	2,5 - 35	2,5 - 35
Connection cross-section, multi-wire		mm <sup>2</sup>	2,5 - 35	2,5 - 35	2,5 - 35
Connection cross-section, flexible		mm <sup>2</sup>	2,5 - 25	2,5 - 25	2,5 - 25
<b>Item No.</b>			<b>5094 67 7</b>	<b>5094 67 9</b>	<b>5094 68 0</b>



# Surge arrester V20, 280 V for TN and TT networks

## Surge arrester, type 2, 280 V

- VDE-tested
- For surge voltage protection equipotential bonding to VDE 0100-443 (IEC 60364-4-44)
- Arresting capacity to 40 kA (8/20) per pin
- Arrester, connectable with dynamic cut-off unit and visual function display
- Encapsulated, non-extinguishing zinc oxide varistor arrester for use in distributor housings
- Base with multiple connection terminals

Application: Equipotential bonding (LPZ 1 to 2) and device protection in main and subdistributors.

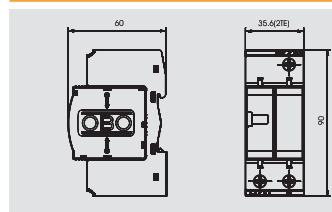
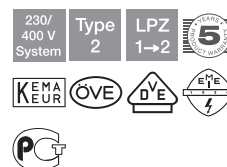

### Surge arrester, 1-pole + NPE

Type	Max. continuous operating voltage V	Version	Pack. pcs	Weight kg/100 pcs.	Item No.
<b>V20-C 1+NPE-280</b>	280	1 + NPE	1	22.300	<b>5094 65 0</b>

/pc.

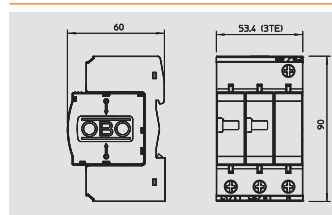

### Surge arrester, 2-pole + NPE

Type	Max. continuous operating voltage V	Version	Pack. pcs	Weight kg/100 pcs.	Item No.
<b>V20-C 2+NPE-280</b>	280	2 + NPE	1	32.300	<b>5094 65 3</b>

/pc.

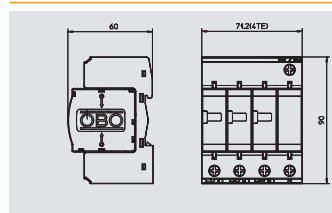

### Surge arrester, 3-pole + NPE

Type	Max. continuous operating voltage V	Version	Pack. pcs	Weight kg/100 pcs.	Item No.
<b>V20-C 3+NPE-280</b>	280	3 + NPE	1	41.700	<b>5094 65 6</b>

/pc.

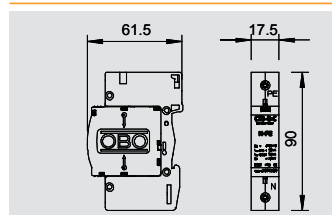

### Surge arrester, 1-pole NPE

Type	Max. continuous operating voltage V	Version	Pack. pcs	Weight kg/100 pcs.	Item No.
<b>C 25-B+C 1</b>	255	NPE	1	12.500	<b>5095 60 6</b>

/pc.



V20-C 1+NPE-280

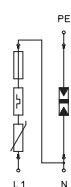

V20-C 2+NPE-280

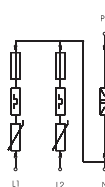

V20-C 3+NPE-280

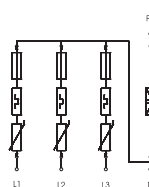

C 25-B+C 1

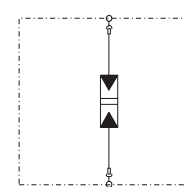

Nominal voltage	$U_N$	V	230	230	230	230
SPD to EN 61643-11			Type 2	Type 2	Type 2	Type 1+2
SPD to IEC 61643-11			class II	class II	class II	class I+II
Lightning protection Zone LPZ			1→2	1→2	1→2	0→2
Nominal discharge current (8/20)	$I_n$	kA	20	20	20	30
Total discharge current (8/20)	$I_{Total}$	kA	40	60	120	
Maximum discharge current	$I_{max}$	kA	40	40	40	50
Voltage protection level	$U_D$	kV	< 1,3	< 1,3	< 1,3	< 1,2
Response time	$t_A$	ns	< 25	< 25	< 25	< 100
Maximum back-up fuse		A	125	125	125	
Temperature range	$\theta$	°C	-40 - +80	-40 - +80	-40 - +80	-40 - +80
Division unit TE (17.5 mm)			2	3	4	1
Degree of protection of enclosure			IP20	IP20	IP20	IP20
Connection cross-section, rigid		mm <sup>2</sup>	2,5 - 35	2,5 - 35	2,5 - 35	2,5 - 35
Connection cross-section, multi-wire		mm <sup>2</sup>	2,5 - 35	2,5 - 35	2,5 - 35	2,5 - 35
Connection cross-section, flexible		mm <sup>2</sup>	2,5 - 25	2,5 - 25	2,5 - 25	2,5 - 25
Lightning impulse current (10/350) (N-PE)	$I_{imp}$	kA				25
Follow current interrupt rating	$I_c$	kA				0.1
<b>Item No.</b>			<b>5094 65 0</b>	<b>5094 65 3</b>	<b>5094 65 6</b>	<b>5095 60 6</b>



# Surge arrester V20, 280 V for TN and TT networks

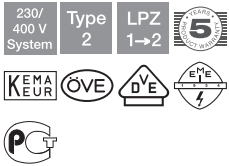

Surge arrester, type 2, 280 V

- VDE-tested
- For surge voltage protection equipotential bonding to VDE 0100-443 (IEC 60364-4-44)
- Arresting capacity to 40 kA (8/20) per pin
- Arrester, connectable with dynamic cut-off unit and visual function display
- Encapsulated, non-extinguishing zinc oxide varistor arrester for use in distributor housings
- Base with multiple connection terminals

Application: Equipotential bonding (LPZ 1 to 2) and device protection in main and subdistributors.

## Surge arrester, 1-pole + NPE with remote signalling



Type	Max. continuous operating voltage V	Version	Pack. pcs	Weight kg/100 pcs.	Item No.
<b>V20-C 1+NPE+FS</b>	280	1 + NPE	1	22.500	<b>5094 76 0</b>

/pc.

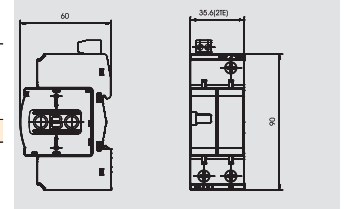

## Surge arrester, 2-pole + NPE with remote signalling



Type	Max. continuous operating voltage V	Version	Pack. pcs	Weight kg/100 pcs.	Item No.
<b>V20-C 2+NPE+FS</b>	280	2 + NPE	1	32.500	<b>5094 76 2</b>

/pc.

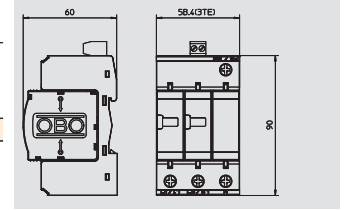

## Surge arrester, 3-pole + NPE with remote signalling



Type	Max. continuous operating voltage V	Version	Pack. pcs	Weight kg/100 pcs.	Item No.
<b>V20-C 3+NPE+FS</b>	280	3 + NPE	1	43.300	<b>5094 76 5</b>

/pc.

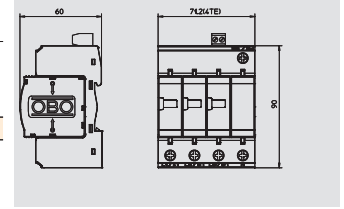

## Surge arrester, 3-pole + NPE with acoustic signalling



Type	Max. continuous operating voltage V	Version	Pack. pcs	Weight kg/100 pcs.	Item No.
<b>V20-C 3+NPE+AS</b>	280	3 + NPE	1	57.000	<b>5096 39 7</b>

/pc.

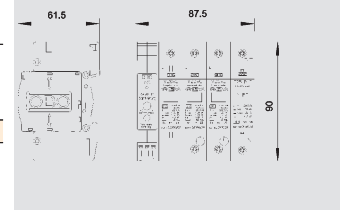

V20-C 1+NPE+FS

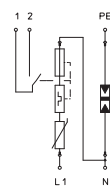

V20-C 2+NPE+FS

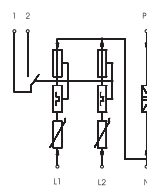

V20-C 3+NPE+FS

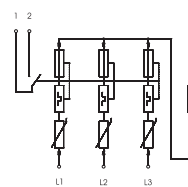

V20-C 3+NPE+AS

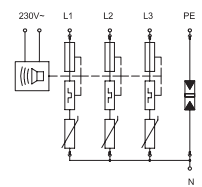

Nominal voltage	$U_N$	V	230	230	230	230
SPD to EN 61643-11			Type 2	Type 2	Type 2	Type 2
SPD to IEC 61643-11			class II	class II	class II	class II
Lightning protection Zone LPZ			1→2	1→2	1→2	1→2
Nominal discharge current (8/20)	$I_n$	kA	20	20	20	20
Total discharge current (8/20)	$I_{Total}$	kA	40	60	80	80
Maximum discharge current	$I_{max}$	kA	40	40	40	40
Voltage protection level	$U_p$	kV	< 1,3	< 1,3	< 1,3	< 1,3
Response time	$t_A$	ns	< 25	< 25	< 25	< 25
Maximum back-up fuse		A	125	125	125	125
Temperature range	$\vartheta$	°C	-40 - +80	-40 - +80	-40 - +80	-40 - +80
Division unit TE (17.5 mm)			2	3	4	5
Degree of protection of enclosure			IP20	IP20	IP20	IP20
Connection cross-section, rigid		mm <sup>2</sup>	2,5 - 35	2,5 - 35	2,5 - 35	2,5 - 35
Connection cross-section, multi-wire		mm <sup>2</sup>	2,5 - 35	2,5 - 35	2,5 - 35	2,5 - 35
Connection cross-section, flexible		mm <sup>2</sup>	2,5 - 25	2,5 - 25	2,5 - 25	2,5 - 25
<b>Item No.</b>			<b>5094 76 0</b>	<b>5094 76 2</b>	<b>5094 76 5</b>	<b>5096 39 7</b>



# Surge arrester V20, 280 V for TN networks

## Surge arrester, type 2, 280 V

- VDE-tested
- For surge voltage protection equipotential bonding to VDE 0100-443 (IEC 60364-4-44)
- Arresting capacity to 40 kA (8/20) per pin
- Arrester, connectable with dynamic cut-off unit and visual function display
- Encapsulated, non-extinguishing zinc oxide varistor arrester for use in distributor housings
- Base with multiple connection terminals

Application: Equipotential bonding (LPZ 1 to 2) and device protection in main and subdistributors.

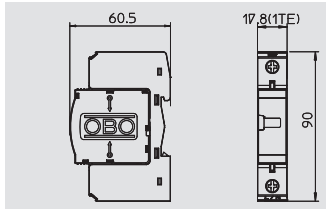

### Surge arrester, 1-pole

Type	Max. continuous operating voltage V	Version	Pack. pcs	Weight kg/100 pcs.	Item No.
<b>V20-C 1-280</b>	280	1-pole	1	12.000	<b>5094 61 8</b>

/pc.

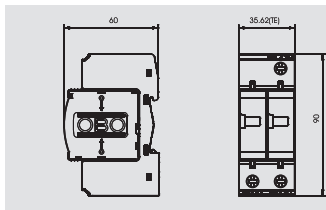

### Surge arrester, 2-pole

Type	Max. continuous operating voltage V	Version	Pack. pcs	Weight kg/100 pcs.	Item No.
<b>V20-C 2-280</b>	280	2-pole	1	22.700	<b>5094 62 1</b>

/pc.

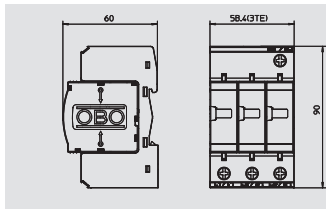

### Surge arrester, 3-pole

Type	Max. continuous operating voltage V	Version	Pack. pcs	Weight kg/100 pcs.	Item No.
<b>V20-C 3-280</b>	280	3-pole	1	33.500	<b>5094 62 4</b>

/pc.

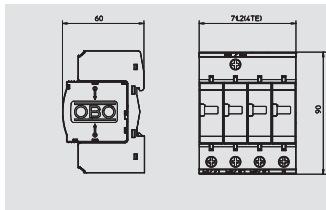

### Surge arrester, 4-pole

Type	Max. continuous operating voltage V	Version	Pack. pcs	Weight kg/100 pcs.	Item No.
<b>V20-C 4-280</b>	280	4-pole	1	43.000	<b>5094 62 7</b>

/pc.



V20-C 1-280



V20-C 2-280

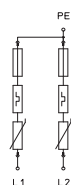

V20-C 3-280

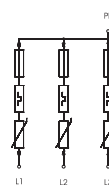

V20-C 4-280

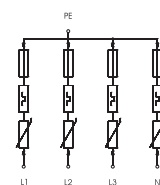

Nominal voltage	$U_N$	V	230	230	230	230
SPD to EN 61643-11			Type 2	Type 2	Type 2	Type 2
SPD to IEC 61643-11			class II	class II	class II	class II
Lightning protection Zone LPZ			1→2	1→2	1→2	1→2
Nominal discharge current (8/20)	$I_n$	kA	20	20	20	20
Total discharge current (8/20)	$I_{Total}$	kA	20	40	60	80
Maximum discharge current	$I_{max}$	kA	40	40	40	40
Voltage protection level	$U_p$	kV	< 1,3	< 1,3	< 1,3	< 1,3
Response time	$t_A$	ns	< 25	< 25	< 25	< 25
Maximum back-up fuse		A	125	125	125	125
Temperature range	$\vartheta$	°C	-40 - +80	-40 - +80	-40 - +80	-40 - +80
Division unit TE (17,5 mm)			1	2	3	4
Degree of protection of enclosure			IP20	IP20	IP20	IP20
Connection cross-section, rigid		mm <sup>2</sup>	2,5 - 35	2,5 - 35	2,5 - 35	2,5 - 35
Connection cross-section, multi-wire		mm <sup>2</sup>	2,5 - 35	2,5 - 35	2,5 - 35	2,5 - 35
Connection cross-section, flexible		mm <sup>2</sup>	2,5 - 25	2,5 - 25	2,5 - 25	2,5 - 25
<b>Item No.</b>			<b>5094 61 8</b>	<b>5094 62 1</b>	<b>5094 62 4</b>	<b>5094 62 7</b>



# Surge arrester V20, 280 V for TN networks



Surge arrester, type 2, 280 V

- VDE-tested
- For surge voltage protection equipotential bonding to VDE 0100-443 (IEC 60364-4-44)
- Arresting capacity to 40 kA (8/20) per pin
- Arrester, connectable with dynamic cut-off unit and visual function display
- Encapsulated, non-extinguishing zinc oxide varistor arrester for use in distributor housings
- Base with multiple connection terminals

Application: Equipotential bonding (LPZ 1 to 2) and device protection in main and subdistributors.

## Surge arrester, 1-pole with remote signalling



Type	Max. continuous operating voltage V	Version	Pack. pcs	Weight kg/100 pcs.	Item No.
<b>V20-C 1+FS-280</b>	280	1-pole	1	12.400	<b>5094 72 7</b>

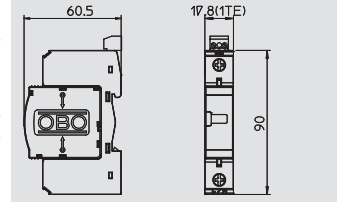

/pc.

## Surge arrester, 2-pole with remote signalling



Type	Max. continuous operating voltage V	Version	Pack. pcs	Weight kg/100 pcs.	Item No.
<b>V20-C 2+FS-280</b>	280	2-pole	1	22.500	<b>5094 63 2</b>

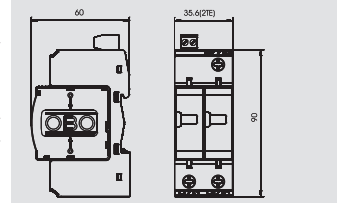

/pc.

## Surge arrester, 3-pole with remote signalling



Type	Max. continuous operating voltage V	Version	Pack. pcs	Weight kg/100 pcs.	Item No.
<b>V20-C 3+FS-280</b>	280	3-pole	1	33.700	<b>5094 73 1</b>

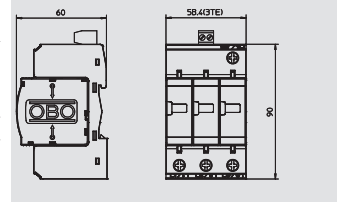

/pc.

## Surge arrester, 4-pole with remote signalling



Type	Max. continuous operating voltage V	Version	Pack. pcs	Weight kg/100 pcs.	Item No.
<b>V20-C 4+FS-280</b>	280	4-pole	1	43.000	<b>5094 73 4</b>

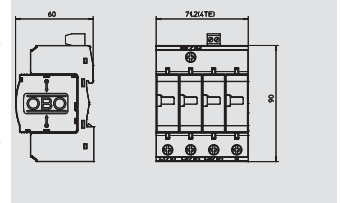

/pc.

V20-C 1+FS-280

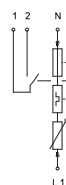

V20-C 2+FS-280



V20-C 3+FS-280

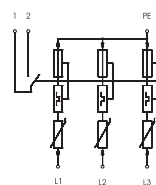

V20-C 4+FS-280

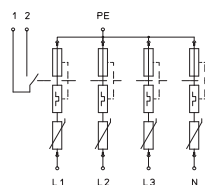

Nominal voltage	$U_N$	V	230	230	230	230
SPD to EN 61643-11			Type 2	Type 2	Type 2	Type 2
SPD to IEC 61643-11			class II	class II	class II	class II
Lightning protection Zone LPZ			1→2	1→2	1→2	1→2
Nominal discharge current (8/20)	$I_n$	kA	20	20	20	20
Total discharge current (8/20)	$I_{Total}$	kA	20	40	60	80
Maximum discharge current	$I_{max}$	kA	40	40	40	40
Voltage protection level	$U_p$	kV	< 1,3	< 1,3	< 1,3	< 1,3
Response time	$t_A$	ns	< 25	< 25	< 25	< 25
Maximum back-up fuse		A	125	125	125	125
Temperature range	$\vartheta$	°C	-40 - +80	-40 - +80	-40 - +80	-40 - +80
Division unit TE (17.5 mm)			1	2	3	4
Degree of protection of enclosure			IP20	IP20	IP20	IP20
Connection cross-section, rigid		mm <sup>2</sup>	2,5 - 35	2,5 - 35	2,5 - 35	2,5 - 35
Connection cross-section, multi-wire		mm <sup>2</sup>	2,5 - 35	2,5 - 35	2,5 - 35	2,5 - 35
Connection cross-section, flexible		mm <sup>2</sup>	2,5 - 25	2,5 - 25	2,5 - 25	2,5 - 25
<b>Item No.</b>			<b>5094 72 7</b>	<b>5094 63 2</b>	<b>5094 73 1</b>	<b>5094 73 4</b>



# Surge arrester V20, 280 V for TN networks

## Surge arrester, type 2, 280 V

- VDE-tested
- For surge voltage protection equipotential bonding to VDE 0100-443 (IEC 60364-4-44)
- Arresting capacity to 40 kA (8/20) per pin
- Arrester, connectable with dynamic cut-off unit and visual function display
- Encapsulated, non-extinguishing zinc oxide varistor arrester for use in distributor housings
- Base with multiple connection terminals

Application: Equipotential bonding (LPZ 1 to 2) and device protection in main and subdistributors.

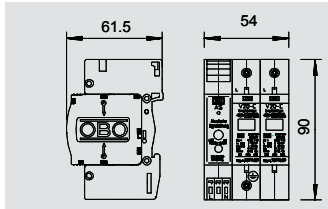

### Surge arrester, 2-pole, with acoustic signalling

Type	Max. continuous operating voltage V	Version	Pack. pcs	Weight kg/100 pcs.	Item No.
<b>V20-C 2+AS-280</b>	280	2-pole	1	35.000	<b>5096 37 5</b>

/pc.

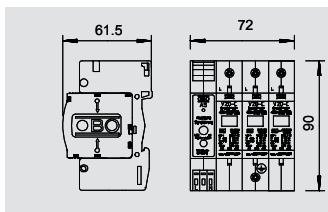

### Surge arrester, 3-pole with acoustic signalling

Type	Max. continuous operating voltage V	Version	Pack. pcs	Weight kg/100 pcs.	Item No.
<b>V20-C 3+AS-280</b>	280	3-pole	1	44.000	<b>5096 38 3</b>

/pc.

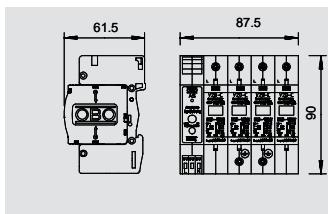

### Surge arrester, 4-pole with acoustic signalling

Type	Max. continuous operating voltage V	Version	Pack. pcs	Weight kg/100 pcs.	Item No.
<b>V20-C 4+AS-280</b>	280	4-pole	1	57.000	<b>5096 39 1</b>

/pc.



V20-C 2+AS-280

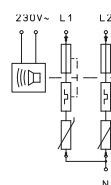

V20-C 3+AS-280

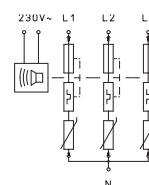

V20-C 4+AS-280

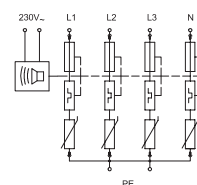

Nominal voltage	$U_N$	V	230	230	230
SPD to EN 61643-11			Type 2	Type 2	Type 2
SPD to IEC 61643-11			class II	class II	class II
Lightning protection Zone LPZ			1-2	1-2	1-2
Nominal discharge current (8/20)	$I_n$	kA	20	20	20
Total discharge current (8/20)	$I_{Total}$	kA	40	60	80
Maximum discharge current	$I_{max}$	kA	40	40	40
Voltage protection level	$U_p$	kV	< 1,3	< 1,3	< 1,3
Response time	$t_A$	ns	< 25	< 25	< 25
Maximum back-up fuse		A	125	125	125
Temperature range	$\vartheta$	°C	-40 - +80	-40 - +80	-40 - +80
Division unit TE (17,5 mm)			3	4	5
Degree of protection of enclosure			IP20	IP20	IP20
Connection cross-section, rigid		mm <sup>2</sup>	2,5 - 35	2,5 - 35	2,5 - 35
Connection cross-section, multi-wire		mm <sup>2</sup>	2,5 - 35	2,5 - 35	2,5 - 35
Connection cross-section, flexible		mm <sup>2</sup>	2,5 - 25	2,5 - 25	2,5 - 25
<b>Item No.</b>			<b>5096 37 5</b>	<b>5096 38 3</b>	<b>5096 39 1</b>



# Surge arrester V20, 280 V for TN networks



Surge arrester, type 2, 280 V

- VDE-tested
  - For surge voltage protection equipotential bonding to VDE 0100-443 (IEC 60364-4-44)
  - Arresting capacity to 40 kA (8/20) per pin
  - Arrester, connectable with dynamic cut-off unit and visual function display
  - Encapsulated, non-extinguishing zinc oxide varistor arrester for use in distributor housings
  - Base with multiple connection terminals
- Application: Equipotential bonding (LPZ 1 to 2) and device protection in main and subdistributors.



## Surge arrester, 3-pole with fuse monitoring

Type	Max. continuous operating voltage V	Version	Pack. pcs	Weight kg/100 pcs.	Item No.
<b>V20-C 3+FS-SÜ</b>	280	3-pole	1	45.000	<b>5096 25 1</b>

/pc.

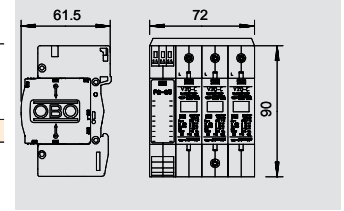

## Surge arrester, 4-pole with fuse monitoring

Type	Max. continuous operating voltage V	Version	Pack. pcs	Weight kg/100 pcs.	Item No.
<b>V20-C 4+FS-SÜ</b>	280	4-pole	1	56.500	<b>5096 27 8</b>

/pc.

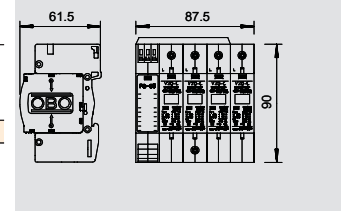

V20-C 3+FS-SÜ

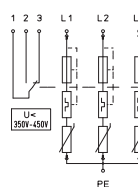

V20-C 4+FS-SÜ

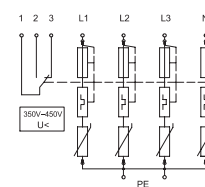

Nominal voltage	$U_N$	V	230	230
SPD to EN 61643-11			Type 2	Type 2
SPD to IEC 61643-11			class II	class II
Lightning protection Zone LPZ			1→2	1→2
Nominal discharge current (8/20)	$I_n$	kA	20	20
Total discharge current (8/20)	$I_{Total}$	kA	60	80
Maximum discharge current	$I_{Tmax}$	kA	40	40
Voltage protection level	$U_p$	kV	< 1,3	< 1,3
Response time	$t_A$	ns	< 25	< 25
Maximum back-up fuse		A	125	125
Temperature range	$\vartheta$	°C	-40 - +80	-40 - +80
Division unit TE (17.5 mm)			4	5
Degree of protection of enclosure			IP20	IP20
Connection cross-section, rigid		mm <sup>2</sup>	2,5 - 35	2,5 - 35
Connection cross-section, multi-wire		mm <sup>2</sup>	2,5 - 35	2,5 - 35
Connection cross-section, flexible		mm <sup>2</sup>	2,5 - 25	2,5 - 25
<b>Item No.</b>			<b>5096 25 1</b>	<b>5096 27 8</b>





# Surge arrester V20, 385 V for TN and TT networks

## Surge arrester, type 2, 385 V

- VDE-tested
- For surge voltage protection equipotential bonding to VDE 0100-443 (IEC 60364-4-44)
- Arresting capacity to 40 kA (8/20) per pin
- Arrester, connectable with dynamic cut-off unit and visual function display
- Encapsulated, non-extinguishing zinc oxide varistor arrester for use in distributor housings
- Base with multiple connection terminals

Application: Equipotential bonding (LPZ 1 to 2) and device protection in main and subdistributors.

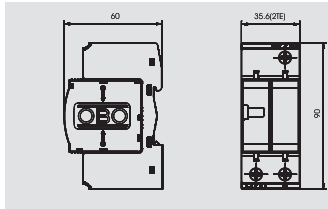

### Surge arrester, 1-pole + NPE

Type	Max. continuous operating voltage V	Version	Pack. pcs	Weight kg/100 pcs.	Item No.
<b>V20-C 1+NPE-385</b>	385	1 + NPE	1	23.300	<b>5094 66 6</b>

/pc.

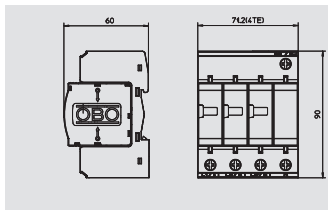

### Surge arrester, 3-pole + NPE

Type	Max. continuous operating voltage V	Version	Pack. pcs	Weight kg/100 pcs.	Item No.
<b>V20-C 3+NPE-385</b>	385	3 + NPE	1	42.600	<b>5094 66 8</b>

/pc.

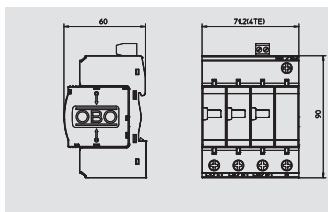

### Surge arrester, 3-pole + NPE with remote signalling

Type	Max. continuous operating voltage V	Version	Pack. pcs	Weight kg/100 pcs.	Item No.
<b>V20-C 3+NPEFS38</b>	385	3 + NPE	1	45.200	<b>5094 78 8</b>

/pc.



V20-C 1+NPE-385

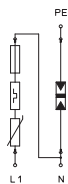

V20-C 3+NPE-385

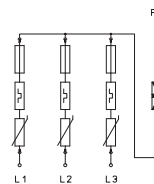

V20-C 3+NPEFS38

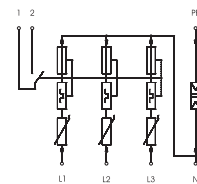

	$U_N$	V	350	350	350
Nominal voltage					
SPD to EN 61643-11			Type 2	Type 2	Type 2
SPD to IEC 61643-11			class II	class II	class II
Lightning protection Zone LPZ			1-2	1-2	1-2
Nominal discharge current (8/20)	$I_n$	kA	20	20	20
Total discharge current (8/20)	$I_{Total}$	kA	40	80	80
Maximum discharge current	$I_{max}$	kA	40	40	40
Voltage protection level	$U_p$	kV	< 1,7	< 1,7	< 1,7
Response time	$t_A$	ns	< 25	< 25	< 25
Maximum back-up fuse		A	125	125	125
Temperature range	$\vartheta$	°C	-40 - +80	-40 - +80	-40 - +80
Division unit TE (17,5 mm)			2	4	4
Degree of protection of enclosure			IP20	IP20	IP20
Connection cross-section, rigid		mm <sup>2</sup>	2,5 - 35	2,5 - 35	2,5 - 35
Connection cross-section, multi-wire		mm <sup>2</sup>	2,5 - 35	2,5 - 35	2,5 - 35
Connection cross-section, flexible		mm <sup>2</sup>	2,5 - 25	2,5 - 25	2,5 - 25
<b>Item No.</b>			<b>5094 66 6</b>	<b>5094 66 8</b>	<b>5094 78 8</b>



# Surge arrester V20, 385 V for TN networks



Surge arrester, type 2, 385 V

- VDE-tested
- For surge voltage protection equipotential bonding to VDE 0100-443 (IEC 60364-4-44)
- Arresting capacity to 40 kA (8/20) per pin
- Arrester, connectable with dynamic cut-off unit and visual function display
- Encapsulated, non-extinguishing zinc oxide varistor arrester for use in distributor housings
- Base with multiple connection terminals

Application: Equipotential bonding (LPZ 1 to 2) and device protection in main and subdistributors.

## Surge arrester, 1-pole



Type	Max. continuous operating voltage V	Version	Pack. pcs	Weight kg/100 pcs.	Item No.
<b>V20-C 1-385</b>	385	1-pole	1	12.500	<b>5094 70 3</b>

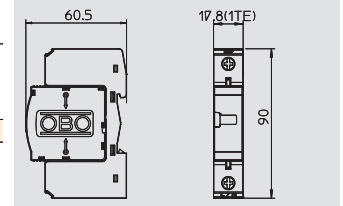

/pc.

## Surge arrester, 2-pole



Type	Max. continuous operating voltage V	Version	Pack. pcs	Weight kg/100 pcs.	Item No.
<b>V20-C 2-385</b>	385	2-pole	1	23.700	<b>5094 70 4</b>

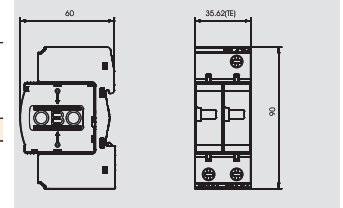

/pc.

## Surge arrester, 3-pole



Type	Max. continuous operating voltage V	Version	Pack. pcs	Weight kg/100 pcs.	Item No.
<b>V20-C 3-385</b>	385	3-pole	1	34.500	<b>5094 70 5</b>

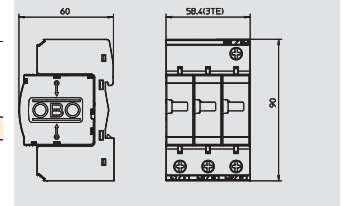

/pc.

## Surge arrester, 4-pole



Type	Max. continuous operating voltage V	Version	Pack. pcs	Weight kg/100 pcs.	Item No.
<b>V20-C 4-385</b>	385	4-pole	1	44.000	<b>5094 70 8</b>

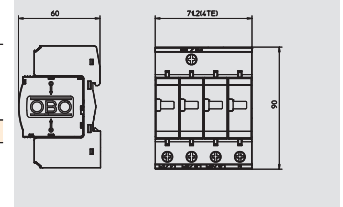

/pc.

V20-C 1-385



V20-C 2-385

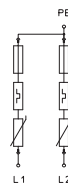

V20-C 3-385

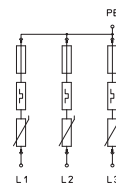

V20-C 4-385

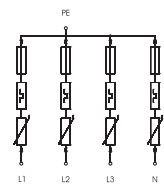

	$U_N$	V	350	350	350	350
Nominal voltage						
SPD to EN 61643-11			Type 2	Type 2	Type 2	Type 2
SPD to IEC 61643-11			class II	class II	class II	class II
Lightning protection Zone LPZ			1→2	1→2	1→2	1→2
Nominal discharge current (8/20)	$I_n$	kA	20	20	20	20
Total discharge current (8/20)	$I_{Total}$	kA	20	40	60	80
Maximum discharge current	$I_{max}$	kA	40	40	40	40
Voltage protection level	$U_p$	kV	< 1,7	< 1,7	< 1,7	< 1,7
Response time	$t_A$	ns	< 25	< 25	< 25	< 25
Maximum back-up fuse		A	125	125	125	125
Temperature range	$\vartheta$	°C	-40 - +80	-40 - +80	-40 - +80	-40 - +80
Division unit TE (17.5 mm)			1	2	3	4
Degree of protection of enclosure			IP20	IP20	IP20	IP20
Connection cross-section, rigid		mm <sup>2</sup>	2,5 - 35	2,5 - 35	2,5 - 35	2,5 - 35
Connection cross-section, multi-wire		mm <sup>2</sup>	2,5 - 35	2,5 - 35	2,5 - 35	2,5 - 35
Connection cross-section, flexible		mm <sup>2</sup>	2,5 - 25	2,5 - 25	2,5 - 25	2,5 - 25
<b>Item No.</b>			<b>5094 70 3</b>	<b>5094 70 4</b>	<b>5094 70 5</b>	<b>5094 70 8</b>



# Surge arrester V20, 385 V for TN networks

## Surge arrester, type 2, 385 V

- VDE-tested
- For surge voltage protection equipotential bonding to VDE 0100-443 (IEC 60364-4-44)
- Arresting capacity to 40 kA (8/20) per pin
- Arrester, connectable with dynamic cut-off unit and visual function display
- Encapsulated, non-extinguishing zinc oxide varistor arrester for use in distributor housings
- Base with multiple connection terminals

Application: Equipotential bonding (LPZ 1 to 2) and device protection in main and subdistributors.

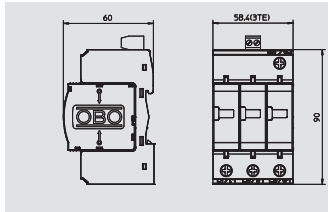

## Surge arrester, 3-pole with remote signalling

Type	Max. continuous operating voltage V	Version	Pack. pcs	Weight kg/100 pcs.	Item No.
V20-C 3+FS-385	385	3-pole	1	34.700	5094 78 0

/pc.

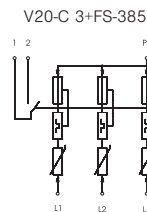

Nominal voltage	$U_N$	V	350
SPD to EN 61643-11			Type 2
SPD to IEC 61643-11			class II
Lightning protection Zone LPZ			1→2
Nominal discharge current (8/20)	$I_n$	kA	20
Total discharge current (8/20)	$I_{Total}$	kA	60
Maximum discharge current	$I_{max}$	kA	40
Voltage protection level	$U_p$	kV	< 1,7
Response time	$t_A$	ns	< 25
Maximum back-up fuse		A	125
Temperature range	$\vartheta$	°C	-40 - +80
Division unit TE (17,5 mm)			3
Degree of protection of enclosure			IP20
Connection cross-section, rigid		mm <sup>2</sup>	2,5 - 35
Connection cross-section, multi-wire		mm <sup>2</sup>	2,5 - 35
Connection cross-section, flexible		mm <sup>2</sup>	2,5 - 25
<b>Item No.</b>			<b>5094 78 0</b>



# Surge arrester V20, 550 V for TN networks



Surge arrester, type 2, 550 V

- VDE-tested
- For surge voltage protection equipotential bonding to VDE 0100-443 (IEC 60364-4-44)
- Arresting capacity to 40 kA (8/20) per pin
- Arrester, connectable with dynamic cut-off unit and visual function display
- Encapsulated, non-extinguishing zinc oxide varistor arrester for use in distributor housings
- Base with multiple connection terminals

Application: Equipotential bonding (LPZ 1 to 2) and device protection in main and subdistributors.

## Surge arrester, 1-pole



Type	Max. continuous operating voltage V	Version	Pack. pcs	Weight kg/100 pcs.	Item No.
V20-C 1-550	550	1-pole	1	12.900	5094 71 3

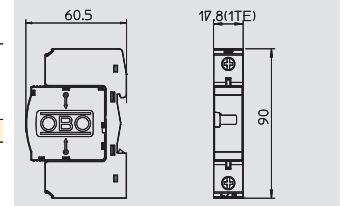

/pc.

## Surge arrester, 2-pole



Type	Max. continuous operating voltage V	Version	Pack. pcs	Weight kg/100 pcs.	Item No.
V20-C 2-550	550	2-pole	1	24.300	5094 71 4

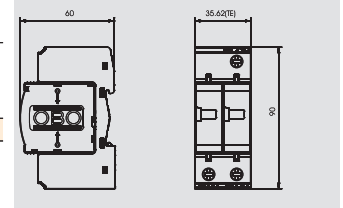

/pc.

## Surge arrester, 3-pole



Type	Max. continuous operating voltage V	Version	Pack. pcs	Weight kg/100 pcs.	Item No.
V20-C 3-550	550	3-pole	1	36.000	5094 71 5

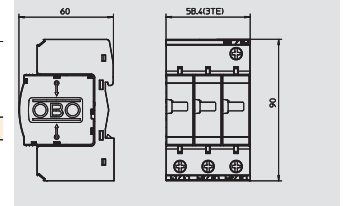

/pc.

## Surge arrester, 4-pole



Type	Max. continuous operating voltage V	Version	Pack. pcs	Weight kg/100 pcs.	Item No.
V20-C 4-550	550	4-pole	1	45.500	5094 71 8

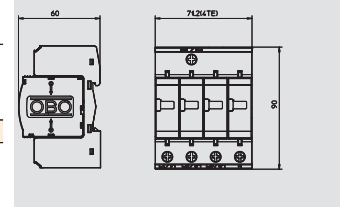

/pc.

V20-C 1-550



V20-C 2-550

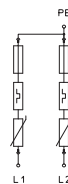

V20-C 3-550

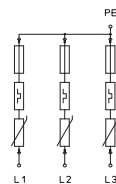

V20-C 4-550

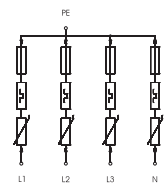

	$U_N$	V	500	500	500	500
Nominal voltage						
SPD to EN 61643-11			Type 2	Type 2	Type 2	Type 2
SPD to IEC 61643-11			class II	class II	class II	class II
Lightning protection Zone LPZ			1→2	1→2	1→2	1→2
Nominal discharge current (8/20)	$I_n$	kA	15	15	15	15
Total discharge current (8/20)	$I_{Total}$	kA	15	30	45	60
Maximum discharge current	$I_{max}$	kA	40	40	40	40
Voltage protection level	$U_p$	kV	< 2,4	< 2,4	< 2,4	< 2,4
Response time	$t_A$	ns	< 25	< 25	< 25	< 25
Maximum back-up fuse		A	125	125	125	125
Temperature range	$\vartheta$	°C	-40 - +80	-40 - +80	-40 - +80	-40 - +80
Division unit TE (17.5 mm)			1	2	3	4
Degree of protection of enclosure			IP20	IP20	IP20	IP20
Connection cross-section, rigid		mm <sup>2</sup>	2,5 - 35	2,5 - 35	2,5 - 35	2,5 - 35
Connection cross-section, multi-wire		mm <sup>2</sup>	2,5 - 35	2,5 - 35	2,5 - 35	2,5 - 35
Connection cross-section, flexible		mm <sup>2</sup>	2,5 - 25	2,5 - 25	2,5 - 25	2,5 - 25
<b>Item No.</b>			<b>5094 71 3</b>	<b>5094 71 4</b>	<b>5094 71 5</b>	<b>5094 71 8</b>



# Surge arrester V20, 550 V for TN networks

Surge arrester, type 2, 550 V

- VDE-tested
- For surge voltage protection equipotential bonding to VDE 0100-443 (IEC 60364-4-44)
- Arresting capacity to 40 kA (8/20) per pin
- Arrester, connectable with dynamic cut-off unit and visual function display
- Encapsulated, non-extinguishing zinc oxide varistor arrester for use in distributor housings
- Base with multiple connection terminals

Application: Equipotential bonding (LPZ 1 to 2) and device protection in main and subdistributors.

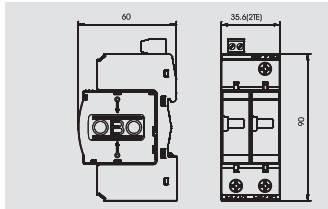

## Surge arrester, 2-pole with remote signalling

Type	Max. continuous operating voltage V	Version	Pack. pcs	Weight kg/100 pcs.	Item No.
<b>V20-C 2+FS-550</b>	550	2-pole	1	24.100	<b>5094 63 6</b>

/pc.

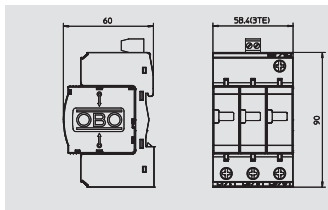

## Surge arrester, 3-pole with remote signalling

Type	Max. continuous operating voltage V	Version	Pack. pcs	Weight kg/100 pcs.	Item No.
<b>V20-C 3+FS-550</b>	550	3-pole	1	36.200	<b>5094 79 2</b>

/pc.

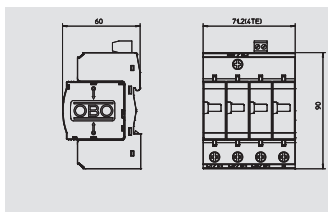

## Surge arrester, 4-pole with remote signalling

Type	Max. continuous operating voltage V	Version	Pack. pcs	Weight kg/100 pcs.	Item No.
<b>V20-C 4+FS-550</b>	550	4-pole	1	45.700	<b>5094 79 5</b>

/pc.



V20-C 2+FS-550

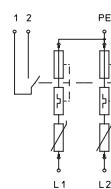

V20-C 3+FS-550

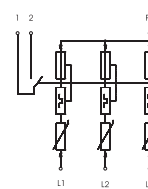

V20-C 4+FS-550

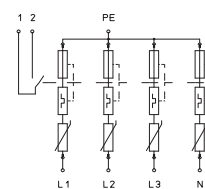

Nominal voltage	$U_N$	V	500	500	500
SPD to EN 61643-11			Type 2	Type 2	Type 2
SPD to IEC 61643-11			class II	class II	class II
Lightning protection Zone LPZ			1-2	1-2	1-2
Nominal discharge current (8/20)	$I_n$	kA	15	15	15
Total discharge current (8/20)	$I_{Total}$	kA	30	45	60
Maximum discharge current	$I_{max}$	kA	40	40	40
Voltage protection level	$U_p$	kV	< 2,4	< 2,4	< 2,4
Response time	$t_A$	ns	< 25	< 25	< 25
Maximum back-up fuse		A	125	125	125
Temperature range	$\vartheta$	°C	-40 - +80	-40 - +80	-40 - +80
Division unit TE (17,5 mm)			2	3	4
Degree of protection of enclosure			IP20	IP20	IP20
Connection cross-section, rigid		mm <sup>2</sup>	2,5 - 35	2,5 - 35	2,5 - 35
Connection cross-section, multi-wire		mm <sup>2</sup>	2,5 - 35	2,5 - 35	2,5 - 35
Connection cross-section, flexible		mm <sup>2</sup>	2,5 - 25	2,5 - 25	2,5 - 25
<b>Item No.</b>			<b>5094 63 6</b>	<b>5094 79 2</b>	<b>5094 79 5</b>

Always indicate the item number when ordering.





## Surge protection energy technology: the plus of the V20-C3+NPE400 for wind power plants

- + Connectable type 2 surge arrester for 400/690 V networks
- + NPE spark gap designed for max. 440 V AC (IEC 60364-5-53)
- + Arresting capacity of the spark gap MB25 up to 25 kA(10/350)
- + Available with remote signalling
- + Visual status display
- + Vibration-proof through Shock Guard
- + Particularly suitable for use in wind power plants



### Function and areas of use

The specially-developed NPE spark gap of type MB25 means that this arrester can be used in 400 V/690 V according to IEC 60364-5-53, as installed in wind power plants.

The international standard for "Lightning protection of wind turbine generators", refers in particular to the selection of electrical protection devices according to IEC 60364-5-53 "Selection and erection of electrical equipment" and their vibration resistance.

In addition, the surge arrester V20-C 3+NPE400 corresponds to the VDE standard 0100-443, "Protection against overvoltages of atmospheric origin or due to switching" with the requirements class, type 2. The high-performance zinc oxide varistor achieves a lower pro-

tection level and combines a high current leakage capability with a long lifespan.

To protect against the risk of fire from overloads, the cut-off unit disconnects the arrester safely from the mains.

# Surge arrester V20, for 400 V/690 V networks

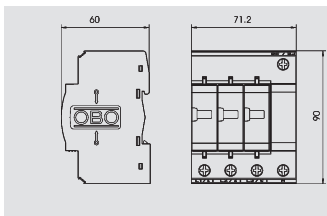

## Surge arrester, 3-pole with NPE

Type	Max. continuous operating voltage V	Version	Pack. pcs	Weight kg/100 pcs.	Item No.
<b>V20-C 3+NPE400</b>	440	3 + NPE	1	47.000	<b>5094 90 0</b>

/pc.

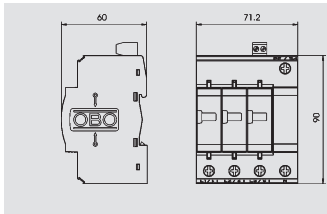

## Surge arrester, 3-pole with NPE and remote signalling

Type	Max. continuous operating voltage V	Version	Pack. pcs	Weight kg/100 pcs.	Item No.
<b>V20-C3+NPE400+FS</b>	440	3 + NPE	1	47.400	<b>5094 90 2</b>

/pc.

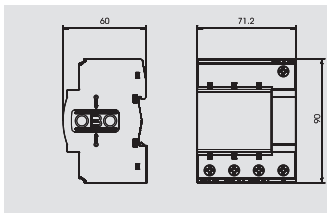

## Multibase MB25 base

Type	Max. continuous operating voltage V	Version	Pack. pcs	Weight kg/100 pcs.	Item No.
<b>MB25-3+NPE</b>	440	3 + NPE	1	27.000	<b>5096 67 2</b>

/pc.

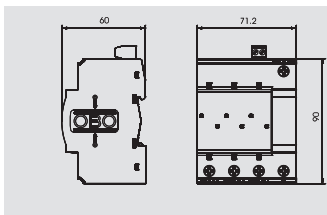

## Multibase MB25 base with remote signalling

Type	Max. continuous operating voltage V	Version	Pack. pcs	Weight kg/100 pcs.	Item No.
<b>MB25-3+NPE+FS</b>	440	3 + NPE	1	29.000	<b>5096 67 3</b>

/pc.



V20-C 3+NPE400

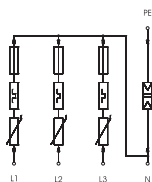

V20-C3+NPE400+FS

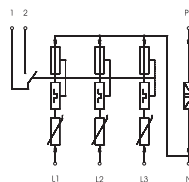

MB25-3+NPE

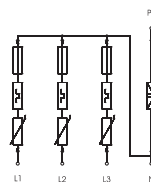

MB25-3+NPE+FS

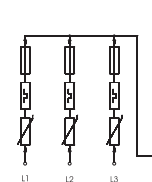

Parameter	Unit	V20-C 3+NPE400	V20-C3+NPE400+FS	MB25-3+NPE	MB25-3+NPE+FS
Nominal voltage	$U_N$ V	400	400	400	400
SPD to EN 61643-11		Type 2	Type 2	Type 1+2	Type 1+2
SPD to IEC 61643-11		class II	class II	class I-II	class I-II
Lightning protection Zone LPZ		1→2	1→2	0→2	0→2
Nominal discharge current (8/20)	$I_n$ kA	20	20		
Total discharge current (8/20)	$I_{Total}$ kA	50	50	50	50
Maximum discharge current	$I_{max}$ kA	40	40		
Voltage protection level	$U_p$ kV	<2,0	<2,0	<2,0	<2,0
Response time	$t_A$ ns	<100	<100	100	100
Maximum back-up fuse	A	125	125	125	125
Temperature range	$\vartheta$ °C	-40 - +80	-40 +80	-40 - +80	-40 - +80
Division unit TE (17,5 mm)		4	4	4	4
Degree of protection of enclosure		IP20	IP20	IP20	IP20
Connection cross-section, rigid	mm <sup>2</sup>	2,5 - 35	2,5 - 35	2,5 - 35	2,5 - 35
Connection cross-section, multi-wire	mm <sup>2</sup>	2,5 - 35	2,5 - 35	2,5 - 35	2,5 - 35
Connection cross-section, flexible	mm <sup>2</sup>	2,5 - 35	2,5 - 35	2,5 - 35	2,5 - 35
<b>Item No.</b>		<b>5094 90 0</b>	<b>5094 90 2</b>	<b>5096 67 2</b>	<b>5096 67 3</b>



# Surge arrester V20, leakage current-free version



Surge arrester, type 2, VA version

- Leak current-free varistor spark gap arrester, use, for example, for permanent insulation monitoring
  - For surge voltage protection equipotential bonding to VDE 0100-443 (IEC 60364-4-44)
  - Arresting capacity to 25 kA (8/20) per pin
  - Arrester, connectable with dynamic cut-off unit and visual function display
  - Encapsulated, non-extinguishing varistor spark gap arrester for use in distributor housings
  - Base with multiple connection terminals
- Application: Pre-meter area and industrial systems with strong power variations.



## Surge arrester, 1-pole, leakage current-free

Type	Max. continuous operating voltage V	Version	Pack. pcs	Weight kg/100 pcs.	Item No.
V20-VA 1-385	385	1-pole	1	12.500	5099 47 5

/pc.

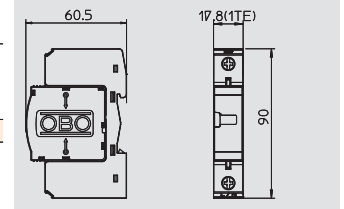

V20-VA 1-385



Nominal voltage	$U_N$	V	350
SPD to EN 61643-11			Type 2
SPD to IEC 61643-11			class II
Lightning protection Zone LPZ			1→2
Nominal discharge current (8/20)	$I_n$	kA	20
Total discharge current (8/20)	$I_{Total}$	kA	20
Maximum discharge current	$I_{max}$	kA	25
Voltage protection level	$U_p$	kV	< 1,8
Response time	$t_A$	ns	< 100
Maximum back-up fuse		A	125
Temperature range	$\vartheta$	°C	-40 - +80
Division unit TE (17.5 mm)			1
Degree of protection of enclosure			IP20
Connection cross-section, rigid		mm <sup>2</sup>	2,5 - 35
Connection cross-section, multi-wire		mm <sup>2</sup>	2,5 - 35
Connection cross-section, flexible		mm <sup>2</sup>	2,5 - 25
<b>Item No.</b>			<b>5099 47 5</b>





# Accessories, upper parts and bases V20

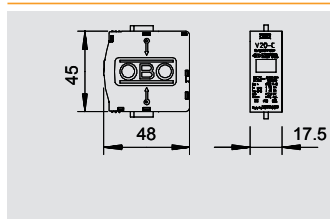

## Upper part, surge arrester 75 V

Type	Max. continuous operating voltage V	U max DC V	Version	Pack. pcs	Weight kg/100 pcs.	Item No.
<b>V20-C 0-75</b>	75	100	1-pole	1	5.160	<b>5099 57 9</b>

/pc.

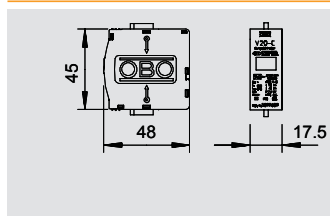

## Upper part, surge arrester 150 V

Type	Max. continuous operating voltage V	U max DC V	Version	Pack. pcs	Weight kg/100 pcs.	Item No.
<b>V20-C 0-150</b>	150	200	1-pole	1	4.790	<b>5096 70 7</b>

/pc.

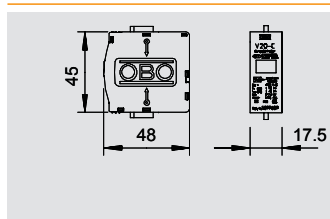

## Upper part, surge arrester 280 V

Type	Max. continuous operating voltage V	U max DC V	Version	Pack. pcs	Weight kg/100 pcs.	Item No.
<b>V20-C 0-280</b>	280	350	1-pole	1	8.500	<b>5099 60 9</b>

/pc.

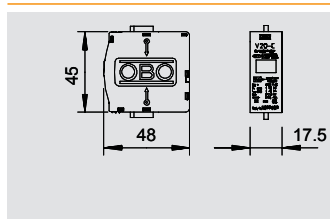

## Upper part, surge arrester 320 V

Type	Max. continuous operating voltage V	U max DC V	Version	Pack. pcs	Weight kg/100 pcs.	Item No.
<b>V20-C 0-320-SP</b>	320	420	1-pole	1	5.550	<b>5099 84 8</b>

/pc.

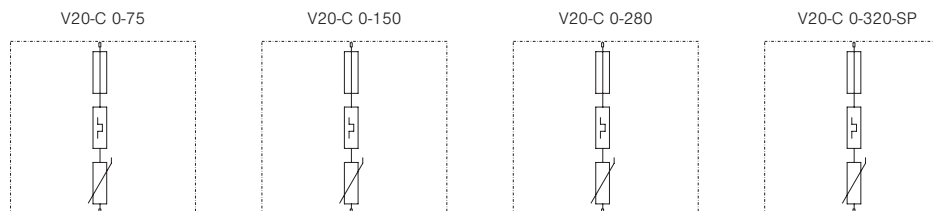

	$U_c$	V	75	150	280	320
Max. continuous operating voltage	$U_c$	V	75	150	280	320
U max DC	$U_c$ DC	V	100	200	350	420
SPD to EN 61643-11			Type 2	Type 2	Type 2	Type 2
SPD to IEC 61643-11			class II	class II	class II	class II
Lightning protection Zone LPZ			1→2	1→2	1→2	1→2
Nominal discharge current (8/20)	$I_n$	kA	15	20	20	20
Maximum discharge current	$I_{Dmax}$	kA	40	40	40	40
Voltage protection level	$U_p$	kV	< 0,5	< 0,8	< 1,3	< 1,4
Response time	$t_A$	ns	< 25	< 25	< 25	< 25
Maximum back-up fuse		A	125	125	125	125
Temperature range	$\theta$	°C	-40 - +80	-40 - +80	-40 - +80	-40 - +80
Degree of protection of enclosure			IP 20	IP 20	IP 20	IP 20
Division unit TE (17.5 mm)			1	1	1	1
<b>Item No.</b>			<b>5099 57 9</b>	<b>5096 70 7</b>	<b>5099 60 9</b>	<b>5099 84 8</b>

Always indicate the item number when ordering.



# Accessories, upper parts and bases V20

Surge protection, arrester, type 2



## Upper part, surge arrester 335 V

Type	Max. continuous operating voltage V	U max DC V	Version	Pack. pcs	Weight kg/100 pcs.	Item No.
<b>V20-C 0-335</b>	335	420	1-pole	1	5.550	<b>5099 85 0</b>

/pc.

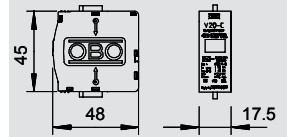

## Upper part, surge arrester 385 V

Type	Max. continuous operating voltage V	U max DC V	Version	Pack. pcs	Weight kg/100 pcs.	Item No.
<b>V20-C 0-385</b>	385	505	1-pole	1	5.830	<b>5099 59 5</b>

/pc.

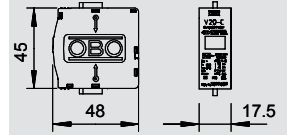

## Upper part, surge arrester 440 V

Type	Max. continuous operating voltage V	U max DC V	Version	Pack. pcs	Weight kg/100 pcs.	Item No.
<b>V20-C 0-440</b>	440	585	1-pole	1	6.450	<b>5099 70 6</b>

/pc.

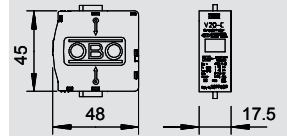

## Upper part, surge arrester 550 V

Type	Max. continuous operating voltage V	U max DC V	Version	Pack. pcs	Weight kg/100 pcs.	Item No.
<b>V20-C 0-550</b>	550	745	1-pole	1	6.450	<b>5099 61 7</b>

/pc.

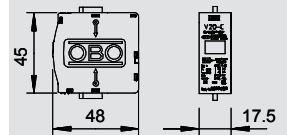

V20-C 0-335

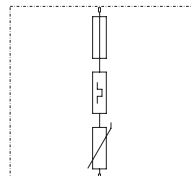

V20-C 0-385

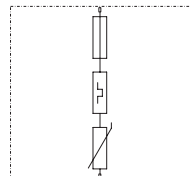

V20-C 0-440

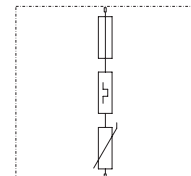

V20-C 0-550

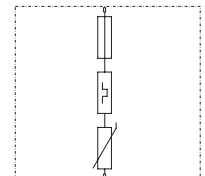

Max. continuous operating voltage	$U_c$	V	335	385	440	550
U max DC	$U_c$	DC V	420	505	585	745
SPD to EN 61643-11			Type 2	Type 2	Type 2	Type 2
SPD to IEC 61643-11			class II	class II	class II	class II
Lightning protection Zone LPZ			1-2	1-2	1-2	1-2
Nominal discharge current (8/20)	$I_n$	kA	20	20	20	15
Maximum discharge current	$I_{max}$	kA	40	40	40	40
Voltage protection level	$U_p$	kV	< 1,4	< 1,7	< 2,0	< 2,4
Response time	$t_A$	ns	< 25	< 25	< 25	< 25
Maximum back-up fuse		A	125	125	125	125
Temperature range	$\vartheta$	°C	-40 - +80	-40 - +80	-40 - +80	-40 - +80
Degree of protection of enclosure			IP 20	IP 20	IP 20	IP 20
Division unit TE (17.5 mm)			1	1	1	1
<b>Item No.</b>			<b>5099 85 0</b>	<b>5099 59 5</b>	<b>5099 70 6</b>	<b>5099 61 7</b>

# Accessories, upper parts and bases V20

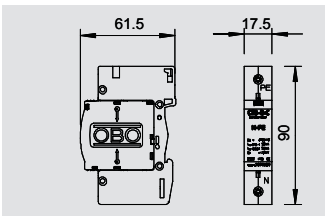

## Surge arrester, 1-pole NPE

Type	Max. continuous operating voltage V	Version	Pack. pcs	Weight kg/100 pcs.	Item No.
<b>C 25-B+C 1</b>	255	NPE	1	12.500	<b>5095 60 6</b>

/pc.

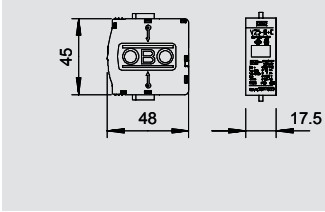

## Upper part total spark gap between N and PE 255 V

Type	Max. continuous operating voltage V	Version	Pack. pcs	Weight kg/100 pcs.	Item No.
<b>C 25-B+C 0</b>	255	NPE	1	5.200	<b>5095 60 3</b>

/pc.

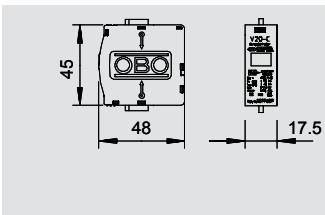

## Upper part, surge protection, leak current-free

Type	Max. continuous operating voltage V	Version	Pack. pcs	Weight kg/100 pcs.	Item No.
<b>V20-VA 0</b>	385	1-pole	1	6.020	<b>5099 61 3</b>

/pc.



Surge protection, arrester, type 2

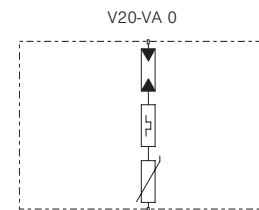
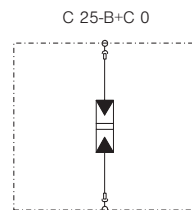
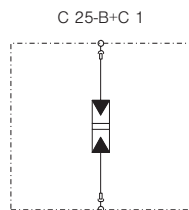

Nominal voltage	$U_N$	V	230	230	230
SPD to EN 61643-11			Type 1+2	Type 1+2	Type 2
SPD to IEC 61643-11			class I+II	class I+II	class II
Lightning protection Zone LPZ			0-2	0-2	1-2
Lightning impulse current (10/350) (N-PE)	$I_{imp}$	kA	25	25	25
Nominal discharge current (8/20)	$I_n$	kA	30	30	20
Maximum discharge current	$I_{max}$	kA	50	50	25
Voltage protection level	$U_D$	kV	<1,2	<1,2	< 1,8
Response time	$t_A$	ns	< 100	< 100	< 100
Follow current interrupt rating	$I_{fi}$	kA	0.1	0.1	
Maximum back-up fuse		A	160	160	125
Temperature range	$\vartheta$	°C	-40 - +80	-40 - +80	-40 - +80
Division unit TE (17.5 mm)			1	1	1
Degree of protection of enclosure			IP20	IP20	IP20
Connection cross-section, rigid		mm <sup>2</sup>	2,5 - 35	2,5 - 35	
Connection cross-section, multi-wire		mm <sup>2</sup>	2,5 - 35	2,5 - 35	
Connection cross-section, flexible		mm <sup>2</sup>	2,5 - 25	2,5 - 25	
Max. continuous operating voltage	$U_c$	V			385
<b>Item No.</b>			<b>5095 60 6</b>	<b>5095 60 3</b>	<b>5099 61 3</b>

# Accessories, upper parts and bases V20



## Base, Multibase

Type	Version	Dividing unit TE (17.5 mm)	Pack. pcs	Weight kg/100 pcs.	Item No.
<b>MB 1</b>	1-pole	1	1	6.200	<b>5096 64 8</b>
<b>MB 2</b>	2-pole	2	1	11.200	<b>5096 65 3</b>
<b>MB 3</b>	3-pole	3	1	16.000	<b>5096 66 5</b>
<b>MB 4</b>	4-pole	4	1	21.000	<b>5096 68 0</b>

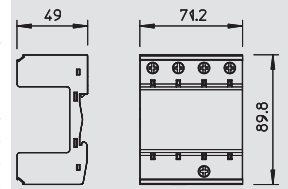

/pc.

- Suitable for V25-B+C, V20-C and V10-C
- Pre-mounted and ready for connection
- For TN systems
- Multifunction terminals for easy circuit of series-mounted devices
- Upper parts can be rotated through 180 degrees



## Base, Multibase with remote signalling

Type	Version	Dividing unit TE (17.5 mm)	Pack. pcs	Weight kg/100 pcs.	Item No.
<b>MB 1+FS</b>	1-pole	1	1	6.700	<b>5096 64 9</b>
<b>MB 2+FS</b>	2-pole	2	1	11.700	<b>5096 65 4</b>
<b>MB 3+FS</b>	3-pole	3	1	16.500	<b>5096 66 7</b>
<b>MB 4+FS</b>	4-pole	4	1	21.000	<b>5096 68 2</b>

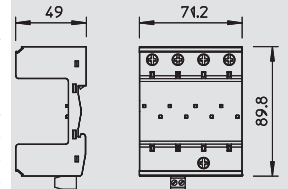

/pc.

- Suitable for V 25-B+C, V 20-C and V10-C
- Pre-mounted and ready for connection
- Multifunction terminals for easy connection to series-mounted devices
- Upper parts can be rotated through 180 degrees
- With remote signalling, potential-free NO contact, for function monitoring



## Base, Multibase + NPE

Type	Version	Dividing unit TE (17.5 mm)	Pack. pcs	Weight kg/100 pcs.	Item No.
<b>MB 1+NPE</b>	1 + NPE	2	1	11.500	<b>5096 65 0</b>
<b>MB 2+NPE</b>	2 + NPE	3	1	16.100	<b>5096 65 5</b>
<b>MB 3+NPE</b>	3 + NPE	4	1	20.000	<b>5096 66 9</b>

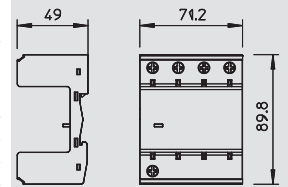

/pc.

- Suitable for V 25-B+C, V 20-C and V10-C
- Pre-mounted and ready for connection
- Multifunction terminals for easy connection to series-mounted devices
- Upper parts can be rotated through 180 degrees
- For TN-S and TT network systems



## Base, Multibase + NPE with remote signalling

Type	Version	Dividing unit TE (17.5 mm)	Pack. pcs	Weight kg/100 pcs.	Item No.
<b>MB 1+NPE+FS</b>	1 + NPE	2	1	11.600	<b>5096 65 1</b>
<b>MB 2+NPE+FS</b>	2 + NPE	3	1	16.000	<b>5096 65 7</b>
<b>MB 3+NPE+FS</b>	3 + NPE	4	1	21.300	<b>5096 67 1</b>

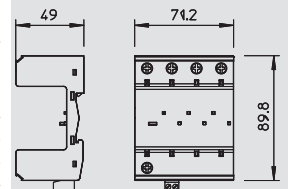

/pc.

- Suitable for V 25-B+C, V 20-C and V10-C
- Pre-mounted and ready for connection
- Multifunction terminals for easy connection to series-mounted devices
- Upper parts can be rotated through 180 degrees
- With remote signalling, potential-free NO contact, for function monitoring
- 3+1 protection circuit for TN-S and TT network systems



## Base, Multibase with fuse monitoring

Type	Version	Pack. pcs	Weight kg/100 pcs.	Item No.
<b>V20-C U-3 FS-SU</b>	3-pole	1	26.000	<b>5096 35 9</b>
<b>V20-C U-4 FS-SU</b>	4-pole	1	33.000	<b>5096 36 7</b>

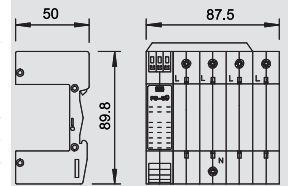

/pc.

- Suitable for V 25-B+C, V 20-C and V 10-C
- With voltage monitoring of phases and function monitoring of arrester upper part, remote signalling
- With remote signaling, potential-free changeover contact, for function monitoring
- Pre-mounted and ready for connection

# Accessories, upper parts and bases V20

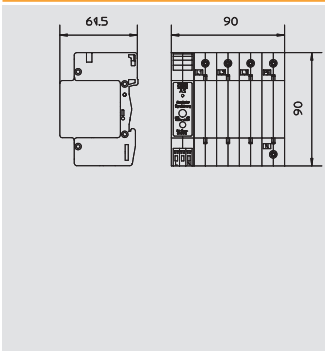

## Base, Multibase with acoustic signalling



Type	Version	Pack.	Weight	Item No.
		pcs	kg/100 pcs.	
V20-C U-2 AS	2-pole	1	23.000	5096 41 3
V20-C U-3 AS	3-pole	1	29.000	5096 42 1
V20-C U-4 AS	4-pole	1	35.000	5096 44 8
V20-C U-3+NPE-AS	3 + NPE	1	32.500	5096 37 2



/pc.

- Suitable for V 25-B+C, V 20-C and V 10-C
- With remote signaling, potential-free changeover contact, for function monitoring
- With acoustic signalling for function monitoring, signal tone can be shut down for 24 h
- Pre-mounted and ready for connection

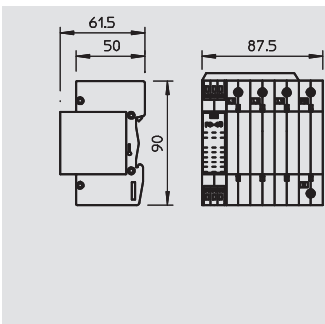

## Base, Multibase + NPE with fuse monitoring



Type	Version	Pack.	Weight	Item No.
		pcs	kg/100 pcs.	
V20-C U-3+NPE	3-NPE with FS-SÜ	1	30.000	5096 37 0



/pc.

- Suitable for V 25-B+C, V 20-C and V 10-C
- With voltage monitoring of phases and function monitoring of arrester upper part, remote signalling
- With remote signalling, potential-free changeover contact, for function monitoring
- For TN-S and TT network systems
- Pre-mounted and ready for connection

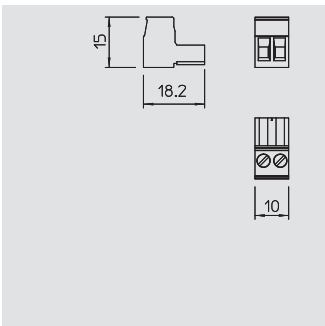

## Remote signalling replacement connector for Multibase



Type	Version	Pack.	Weight	Item No.
		pcs	kg/100 pcs.	
MB-FS	2-pole	25	0.310	5096 69 3



/pc.

Replacement telephony connector, 2-pin version, for Multibase base

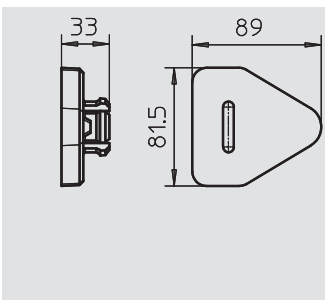

## Shock Guard locking



Type	Colour	Version	Pack.	Weight	Item No.
			pcs	kg/100 pcs.	
MB-SG	Blue	Locking system for upper parts	100	0.060	5096 69 5



/pc.





PA Polyamide

- Shock Guard: Locking for connector technology on MultiBase bases
- Locking system for the plug-in modules/covers
- Vibration and shock-tested
- Use in housing hole of the connection terminals
- Upper parts can be removed without tools





## Surge protection energy technology, arrester, type 2+3

	Surge arrester	V10 Compact	200
		V10, 280 V	202
		V10, 320 V	203
	Accessories, upper parts and bases V10		204
	Protection packages		207



# Surge arrester V10 Compact



Surge arrester, compact module, type 2+3

- For surge protection equipotential bonding to VDE 0100-443 (IEC 60364-4-44)
- Arresting capacity to 60 kA (8/20) in total
- Incl. thermal and dynamic cut-off unit and visual function display
- Encapsulated, non-extinguishing zinc oxide varistor arrester for use in distributor housings
- Integrated 3+1 solution for TN and TT network systems of a 45 mm module width

Application: Industry, housing and device protection of rotary current systems.



## Surge arrester Compact 150 V

Type	Max. continuous operating voltage V	Version	Pack. pcs	Weight kg/100 pcs.	Item No.
<b>V10 COMPACT 150</b>	150	3 + NPE	1	15.800	<b>5093 37 8</b>

/pc.

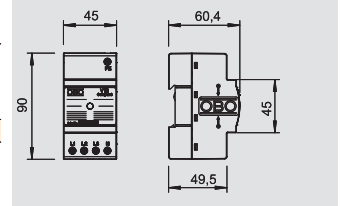

## Surge arrester Compact 280 V

Type	Max. continuous operating voltage V	Version	Pack. pcs	Weight kg/100 pcs.	Item No.
<b>V10 COMPACT 255</b>	255	3 + NPE	1	15.800	<b>5093 38 0</b>

/pc.

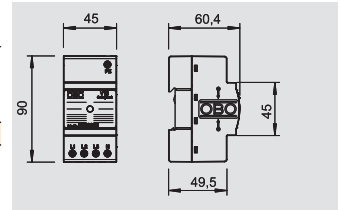

## Surge arrester Compact 385 V

Type	Max. continuous operating voltage V	Version	Pack. pcs	Weight kg/100 pcs.	Item No.
<b>V10 COMPACT 385</b>	385	3 + NPE	1	16.800	<b>5093 38 4</b>

/pc.

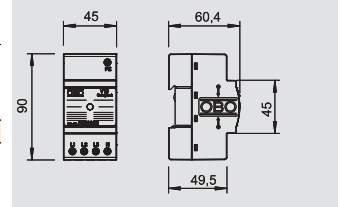

## Surge arrester Compact with acoustic signalling

Type	Max. continuous operating voltage V	Version	Pack. pcs	Weight kg/100 pcs.	Item No.
<b>V10 COMPACT-AS</b>	255	3 + NPE	1	15.800	<b>5093 39 1</b>

/pc.

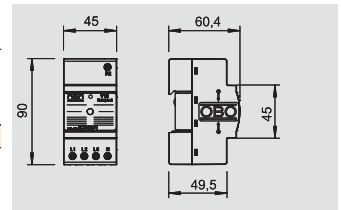

V10 COMPACT 150

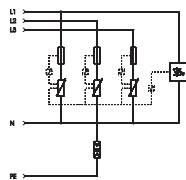

V10 COMPACT 255

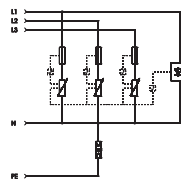

V10 COMPACT 385

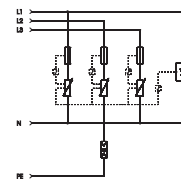

V10 COMPACT-AS

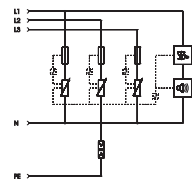

Nominal voltage	$U_N$	V	130	230	385	230
SPD to EN 61643-11			Type 2+3	Type 2+3	Type 2+3	Type 2+3
SPD to IEC 61643-11			class II+III	class II+III	class II+III	class II+III
Lightning protection Zone LPZ			1-3	1-3	1-3	1-3
Nominal discharge current (8/20)	$I_n$	kA	10	10	10	10
Total discharge current (8/20)	$I_{Total}$	kA	60	60	60	60
Maximum discharge current	$I_{max}$	kA	20	20	20	20
Voltage protection level	$U_p$	kV	< 0,7	< 1,1	< 1,5	< 1,1
Response time	$t_A$	ns	< 25	< 25	< 25	< 25
Maximum back-up fuse		A	63	63	63	63
Temperature range	$\vartheta$	°C	-40 - +80	-40 - +80	-40 - +80	-40 - +80
Division unit TE (17.5 mm)			2.5	2.5	2.5	2.5
Degree of protection of enclosure			IP20	IP20	IP20	IP20
Connection cross-section, rigid		mm <sup>2</sup>	2,5 - 10	2,5 - 10	2,5 - 10	2,5 - 10
Connection cross-section, multi-wire		mm <sup>2</sup>	2,5 - 10	2,5 - 10	2,5 - 10	2,5 - 10
Connection cross-section, flexible		mm <sup>2</sup>	2,5 - 10	2,5 - 10	2,5 - 10	2,5 - 10
<b>Item No.</b>			<b>5093 37 8</b>	<b>5093 38 0</b>	<b>5093 38 4</b>	<b>5093 39 1</b>





Surge arrester, compact module, type 2+3

- For surge protection equipotential bonding to VDE 0100-443 (IEC 60364-4-44)
- Arresting capacity to 60 kA (8/20) in total
- Incl. thermal and dynamic cut-off unit and visual function display
- Encapsulated, non-extinguishing zinc oxide varistor arrester for use in distributor housings
- Integrated 3+1 solution for TN and TT network systems of a 45 mm module width



Application: Industry, housing and device protection of rotary current systems.

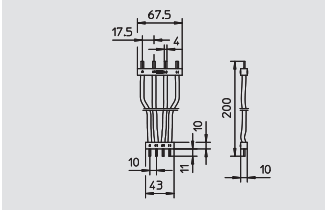

### Connecting bridge for V10 Compact 200 mm

Type	Version	Pack.	Weight	Item No.
		pcs	kg/100 pcs.	
<b>VB-V10 COMPACT-2</b>	200 mm	1	5.300	<b>5089 65 0</b>

/pc.

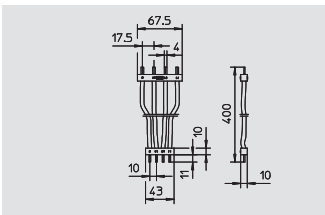

### Connecting bridge for V10 Compact 400 mm

Type	Version	Pack.	Weight	Item No.
		pcs	kg/100 pcs.	
<b>VB-V10 COMPACT-4</b>	400 mm	1	8.900	<b>5089 65 2</b>

/pc.



Surge protection, arrester, type 2+3



# Surge arrester V10, 280 V



Surge arrester, type 2+3

- For surge voltage protection equipotential bonding to VDE 0100-443 (IEC 60364-4-44)
- Arresting capacity to 20 kA (8/20) per pin
- Arrester, connectable with dynamic cut-off unit and visual function display
- Encapsulated, non-extinguishing zinc oxide varistor arrester for use in distributor housings
- Base with multiple connection terminals

Application: Equipotential bonding and device protection in main and subdistributors



## Surge arrester, 3-pole + NPE

Type	Max. continuous operating voltage V	Version	Pack. pcs	Weight kg/100 pcs.	Item No.
<b>V10-C 3+NPE</b>	280	3 + NPE	1	37.800	<b>5094 92 0</b>

/pc.

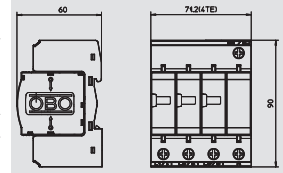

## Surge arrester, 3-pole + NPE with remote signalling

Type	Max. continuous operating voltage V	Version	Pack. pcs	Weight kg/100 pcs.	Item No.
<b>V10-C 3+NPE+FS</b>	280	3 + NPE	1	37.900	<b>5094 93 1</b>

/pc.

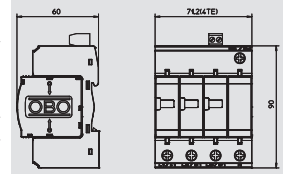

## Surge arrester, 1-pole + NPE

Type	Max. continuous operating voltage V	Version	Pack. pcs	Weight kg/100 pcs.	Item No.
<b>V10-C 1+NPE-280</b>	280	1 + NPE	1	22.200	<b>5093 41 8</b>

/pc.

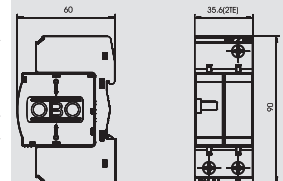

V10-C 3+NPE

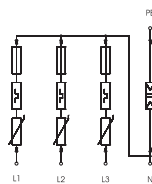

V10-C 3+NPE+FS

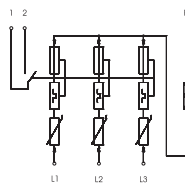

V10-C 1+NPE-280

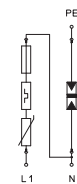

Nominal voltage	$U_N$	V	230	230	230
SPD to EN 61643-11			Type 2+3	Type 2+3	Type 2+3
SPD to IEC 61643-11			class II+III	class II+III	class II+III
Lightning protection Zone LPZ			1-3	1-3	1-3
Nominal discharge current (8/20)	$I_n$	kA	10	10	10
Total discharge current (8/20)	$I_{Total}$	kA	40	40	40
Maximum discharge current	$I_{Tmax}$	kA	20	20	20
Voltage protection level	$U_p$	kV	< 1,1	< 1,1	< 1,1
Response time	$t_A$	ns	<25	<25	< 25
Maximum back-up fuse		A	125	125	125
Temperature range	$\vartheta$	°C	-40 - +80	-40 - +80	-40 - +80
Division unit TE (17.5 mm)			4	4	2
Degree of protection of enclosure			IP20	IP20	IP20
Connection cross-section, rigid		mm <sup>2</sup>	2,5 - 35	2,5 - 35	2,5 - 35
Connection cross-section, multi-wire		mm <sup>2</sup>	2,5 - 35	2,5 - 35	2,5 - 35
Connection cross-section, flexible		mm <sup>2</sup>	2,5 - 25	2,5 - 25	2,5 - 35
<b>Item No.</b>			<b>5094 92 0</b>	<b>5094 93 1</b>	<b>5093 41 8</b>



# Surge arrester V10, 320 V

## Surge arrester, type 2+3

- For surge voltage protection equipotential bonding to VDE 0100-443 (IEC 60364-4-44)
- Arresting capacity to 20 kA (8/20) per pin
- Arrester, connectable with dynamic cut-off unit and visual function display
- Encapsulated, non-extinguishing zinc oxide varistor arrester for use in distributor housings
- Base with multiple connection terminals

Application: Equipotential bonding and device protection in main and subdistributors

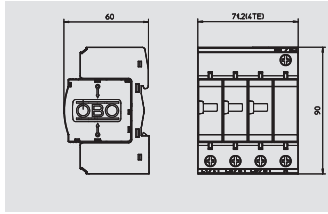

## Surge arrester, 3-pole + NPE

Type	Max. continuous operating voltage V	Version	Pack. pcs	Weight kg/100 pcs.	Item No.
<b>V10-C 3+NPE-320</b>	320	3 + NPE	1	39.000	<b>5094 92 4</b>

/pc.



Surge protection, arrester, type 2+3



02\_TBS\_Masterkatalog\_Länder\_2012 / en / 29/05/2012 (LExport\_01433) / 29/05/2012

V10-C 3+NPE-320

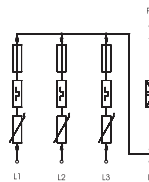

Nominal voltage	$U_N$	V	320
SPD to EN 61643-11			Type 2+3
SPD to IEC 61643-11			class II+III
Lightning protection Zone LPZ			1-3
Nominal discharge current (8/20)	$I_n$	kA	10
Total discharge current (8/20)	$I_{Total}$	kA	40
Maximum discharge current	$I_{max}$	kA	20
Voltage protection level	$U_p$	kV	< 1,2
Response time	$t_A$	ns	<25
Maximum back-up fuse		A	125
Temperature range	$\vartheta$	°C	-40 - +80
Division unit TE (17,5 mm)			4
Degree of protection of enclosure			IP20
Connection cross-section, rigid		mm <sup>2</sup>	2,5 - 35
Connection cross-section, multi-wire		mm <sup>2</sup>	2,5 - 35
Connection cross-section, flexible		mm <sup>2</sup>	2,5 - 25
<b>Item No.</b>			<b>5094 92 4</b>

# Accessories, upper parts and bases V10

Surge protection, arrester, type 2+3



## Upper part, surge arrester 150 V

Type	Max. continuous operating voltage V	Version	Pack. pcs	Weight kg/100 pcs.	Item No.
<b>V10-C 0-150</b>	150	1-pole	1	3.300	<b>5093 40 0</b>

/pc.

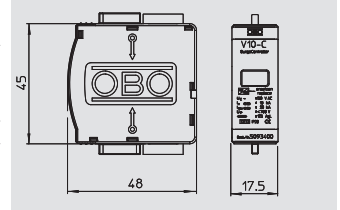

## Upper part, surge arrester 280 V

Type	Max. continuous operating voltage V	Version	Pack. pcs	Weight kg/100 pcs.	Item No.
<b>V10-C 0-280</b>	280	1-pole	1	3.360	<b>5093 40 2</b>

/pc.

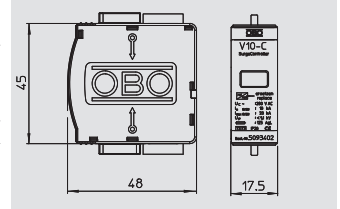

## Upper part, surge arrester 320 V

Type	Max. continuous operating voltage V	Version	Pack. pcs	Weight kg/100 pcs.	Item No.
<b>V10-C 0-320</b>	320	1-pole	1	3.510	<b>5093 40 4</b>

/pc.

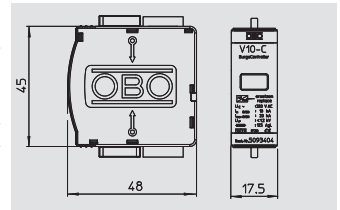

## Upper part, surge arrester 385 V

Type	Max. continuous operating voltage V	Version	Pack. pcs	Weight kg/100 pcs.	Item No.
<b>V10-C 0-385</b>	385	1-pole	30	3.630	<b>5093 40 6</b>

/pc.

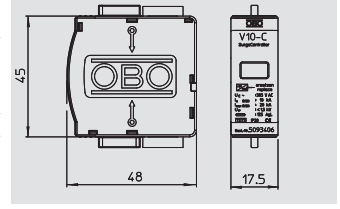

V10-C 0-150

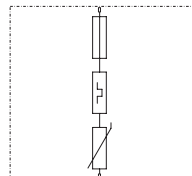

V10-C 0-280

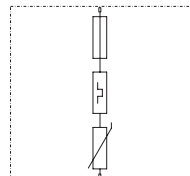

V10-C 0-320

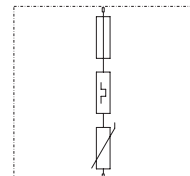

V10-C 0-385

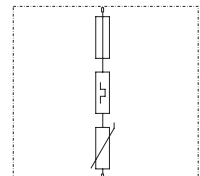

Max. continuous operating voltage	$U_c$	V	150	280	320	385
SPD to EN 61643-11			Type 2+3	Type 2+3	Type 2+3	Type 2+3
SPD to IEC 61643-11			class II+III	class II+III	class II+III	class II+III
Lightning protection Zone LPZ			1-3	1-3	1-3	1-3
Nominal discharge current (8/20)	$I_n$	kA	10	10	10	10
Total discharge current (8/20)	$I_{Total}$	kA	10	10	10	10
Maximum discharge current	$I_{max}$	kA	20	20	20	20
Voltage protection level	$U_p$	kV	< 0,7	< 1,1	< 1,2	< 1,5
Response time	$t_A$	ns	< 25	< 25	< 25	< 25
Maximum back-up fuse		A	125	125	125	125
Temperature range	$\vartheta$	°C	-40 - +80	-40 - +80	-40 - +80	-40 - +80
Division unit TE (17.5 mm)			1	1	1	1
Degree of protection of enclosure			IP20	IP20	IP20	IP20
<b>Item No.</b>			<b>5093 40 0</b>	<b>5093 40 2</b>	<b>5093 40 4</b>	<b>5093 40 6</b>

# Accessories, upper parts and bases V10

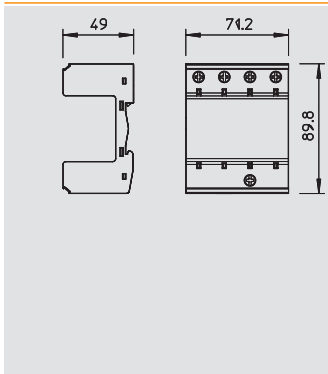

## Base, Multibase



Type	Version	Dividing unit TE (17.5 mm)	Pack. pcs	Weight kg/100 pcs.	Item No.
<b>MB 1</b>	1-pole	1	1	6.200	<b>5096 64 8</b>
<b>MB 2</b>	2-pole	2	1	11.200	<b>5096 65 3</b>
<b>MB 3</b>	3-pole	3	1	16.000	<b>5096 66 5</b>
<b>MB 4</b>	4-pole	4	1	21.000	<b>5096 68 0</b>



/pc.

- Suitable for V25-B+C, V20-C and V10-C
- Pre-mounted and ready for connection
- For TN systems
- Multifunction terminals for easy circuit of series-mounted devices
- Upper parts can be rotated through 180 degrees

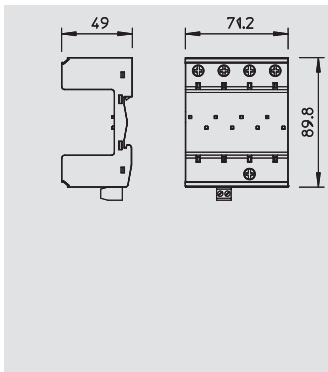

## Base, Multibase with remote signalling



Type	Version	Dividing unit TE (17.5 mm)	Pack. pcs	Weight kg/100 pcs.	Item No.
<b>MB 1+FS</b>	1-pole	1	1	6.700	<b>5096 64 9</b>
<b>MB 2+FS</b>	2-pole	2	1	11.700	<b>5096 65 4</b>
<b>MB 3+FS</b>	3-pole	3	1	16.500	<b>5096 66 7</b>
<b>MB 4+FS</b>	4-pole	4	1	21.000	<b>5096 68 2</b>



/pc.

- Suitable for V 25-B+C, V 20-C and V10-C
- Pre-mounted and ready for connection
- Multifunction terminals for easy connection to series-mounted devices
- Upper parts can be rotated through 180 degrees
- With remote signalling, potential-free NO contact, for function monitoring

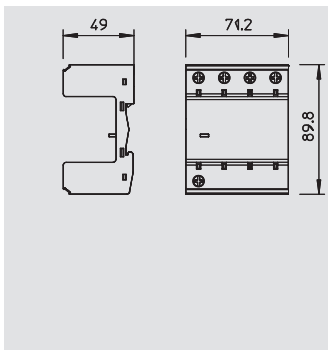

## Base, Multibase + NPE



Type	Version	Dividing unit TE (17.5 mm)	Pack. pcs	Weight kg/100 pcs.	Item No.
<b>MB 1+NPE</b>	1 + NPE	2	1	11.500	<b>5096 65 0</b>
<b>MB 2+NPE</b>	2 + NPE	3	1	16.100	<b>5096 65 5</b>
<b>MB 3+NPE</b>	3 + NPE	4	1	20.000	<b>5096 66 9</b>



/pc.

- Suitable for V 25-B+C, V 20-C and V10-C
- Pre-mounted and ready for connection
- Multifunction terminals for easy connection to series-mounted devices
- Upper parts can be rotated through 180 degrees
- For TN-S and TT network systems

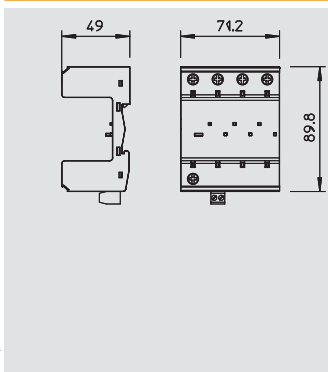

## Base, Multibase + NPE with remote signalling



Type	Version	Dividing unit TE (17.5 mm)	Pack. pcs	Weight kg/100 pcs.	Item No.
<b>MB 1+NPE+FS</b>	1 + NPE	2	1	11.600	<b>5096 65 1</b>
<b>MB 2+NPE+FS</b>	2 + NPE	3	1	16.000	<b>5096 65 7</b>
<b>MB 3+NPE+FS</b>	3 + NPE	4	1	21.300	<b>5096 67 1</b>



/pc.

- Suitable for V 25-B+C, V 20-C and V10-C
- Pre-mounted and ready for connection
- Multifunction terminals for easy connection to series-mounted devices
- Upper parts can be rotated through 180 degrees
- With remote signalling, potential-free NO contact, for function monitoring
- 3+1 protection circuit for TN-S and TT network systems

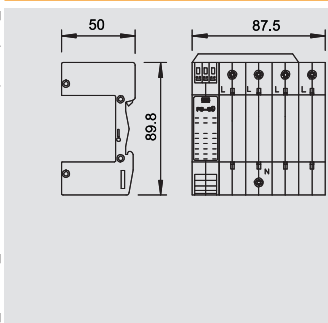

## Base, Multibase with fuse monitoring



Type	Version	Pack. pcs	Weight kg/100 pcs.	Item No.
<b>V20-C U-3 FS-SU</b>	3-pole	1	26.000	<b>5096 35 9</b>
<b>V20-C U-4 FS-SU</b>	4-pole	1	33.000	<b>5096 36 7</b>



/pc.

- Suitable for V 25-B+C, V 20-C and V 10-C
- With voltage monitoring of phases and function monitoring of arrester upper part, remote signalling
- With remote signaling, potential-free changeover contact, for function monitoring
- Pre-mounted and ready for connection

02\_TBS\_Masterkatalog\_Länder\_2012 / en / 29/05/2012 (LLEExport\_014333) / 29/05/2012

Surge protection, arrester, type 2+3

# Accessories, upper parts and bases V10



## Base, Multibase with acoustic signalling

Type	Version	Pack.	Weight	Item No.
		pcs	kg/100 pcs.	
V20-C U-2 AS	2-pole	1	23.000	5096 41 3
V20-C U-3 AS	3-pole	1	29.000	5096 42 1
V20-C U-4 AS	4-pole	1	35.000	5096 44 8
V20-C U-3+NPE-AS	3 + NPE	1	32.500	5096 37 2

/pc.

- Suitable for V 25-B+C, V 20-C and V 10-C
- With remote signalling, potential-free changeover contact, for function monitoring
- With acoustic signalling for function monitoring, signal tone can be shut down for 24 h
- Pre-mounted and ready for connection

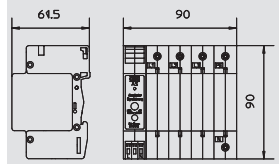

## Base, Multibase + NPE with fuse monitoring

Type	Version	Pack.	Weight	Item No.
		pcs	kg/100 pcs.	
V20-C U-3+NPE	3-NPE with FS-SU	1	30.000	5096 37 0

/pc.

- Suitable for V 25-B+C, V 20-C and V 10-C
- With voltage monitoring of phases and function monitoring of arrester upper part, remote signalling
- With remote signalling, potential-free changeover contact, for function monitoring
- For TN-S and TT network systems
- Pre-mounted and ready for connection

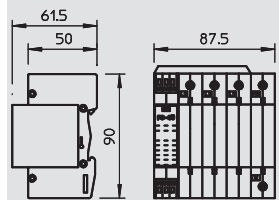

## Copper bridges with step width 17.6 mm

Type	Version	Pack.	Weight	Item No.
		pcs	kg/100 pcs.	
KB MB	Step width 17.6 mm	10	0.900	5089 66 0

/pc.

The KB... bridges allow parallel switching of bases and poles of the MultiBase bases. The bridges are available in various widths.

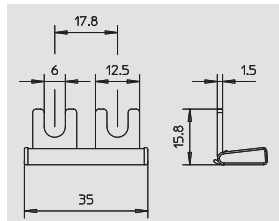

## Copper bridges with step width 53.4 mm

Type	Version	Pack.	Weight	Item No.
		pcs	kg/100 pcs.	
KB MB	Step width 53.4 mm	10	1.470	5089 66 2

/pc.

The bridges KB... permit parallel connection of bases and poles of the MultiBase bases. The bridges are available in various widths.

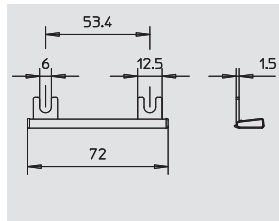

## Shock Guard locking

Type	Colour	Version	Pack.	Weight	Item No.
			pcs	kg/100 pcs.	
MB-SG	Blue	Locking system for upper parts	100	0.060	5096 69 5

/pc.

PA Polyamide

Shock Guard: Locking for connector technology on MultiBase bases  
Locking system for the plug-in modules/covers  
Vibration and shock-tested  
Use in housing hole of the connection terminals  
Upper parts can be removed without tools

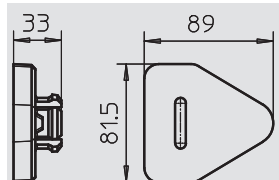

## Remote signalling replacement connector for Multibase

Type	Version	Pack.	Weight	Item No.
		pcs	kg/100 pcs.	
MB-FS	2-pole	25	0.310	5096 69 3

/pc.

Replacement telephony connector, 2-pin version, for Multibase base

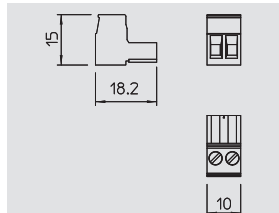

## OBO protection packages with surge arrester



- For surge voltage protection equipotential bonding to VDE 0100-443 (IEC 60364-4-44)
- Type 2 surge protection with arresting capacity to 40 kA (8/20) per pin
- Type 2 arrester, connectable with dynamic cut-off unit and function display
- Type 3 (fine protection device) in TC, SAT or TV version

The appropriate adapters and data cables are included in the protection package.

Application: Equipotential bonding and device protection, VDE and GS tested.

### Protection package, telecommunications

Type	Version	Pack.	Weight	Item No.
		pcs	kg/100 pcs.	
<b>P-TK</b>	1 x V20-C/3+NPE 2 x FC-D 1 x FC-TAE-D	1	92.000	<b>5086 01 9</b>

/pc.



### Protection package, SAT applications

Type	Version	Pack.	Weight	Item No.
		pcs	kg/100 pcs.	
<b>P-TK+SAT</b>	1 x V20-C/3+NPE 1 x FC-D 1 x FC-TAE-D 1 x FC-SAT-D	1	98.000	<b>5086 02 3</b>

/pc.



### Protection package, TV

Type	Version	Pack.	Weight	Item No.
		pcs	kg/100 pcs.	
<b>P-TK+TV</b>	1 x V20-C/3+NPE 1 x FC-D 1 x FC-TAE-D 1 x FC-TV-D	1	98.000	<b>5086 02 7</b>

/pc.





Surge protection, arrester, type 2+3

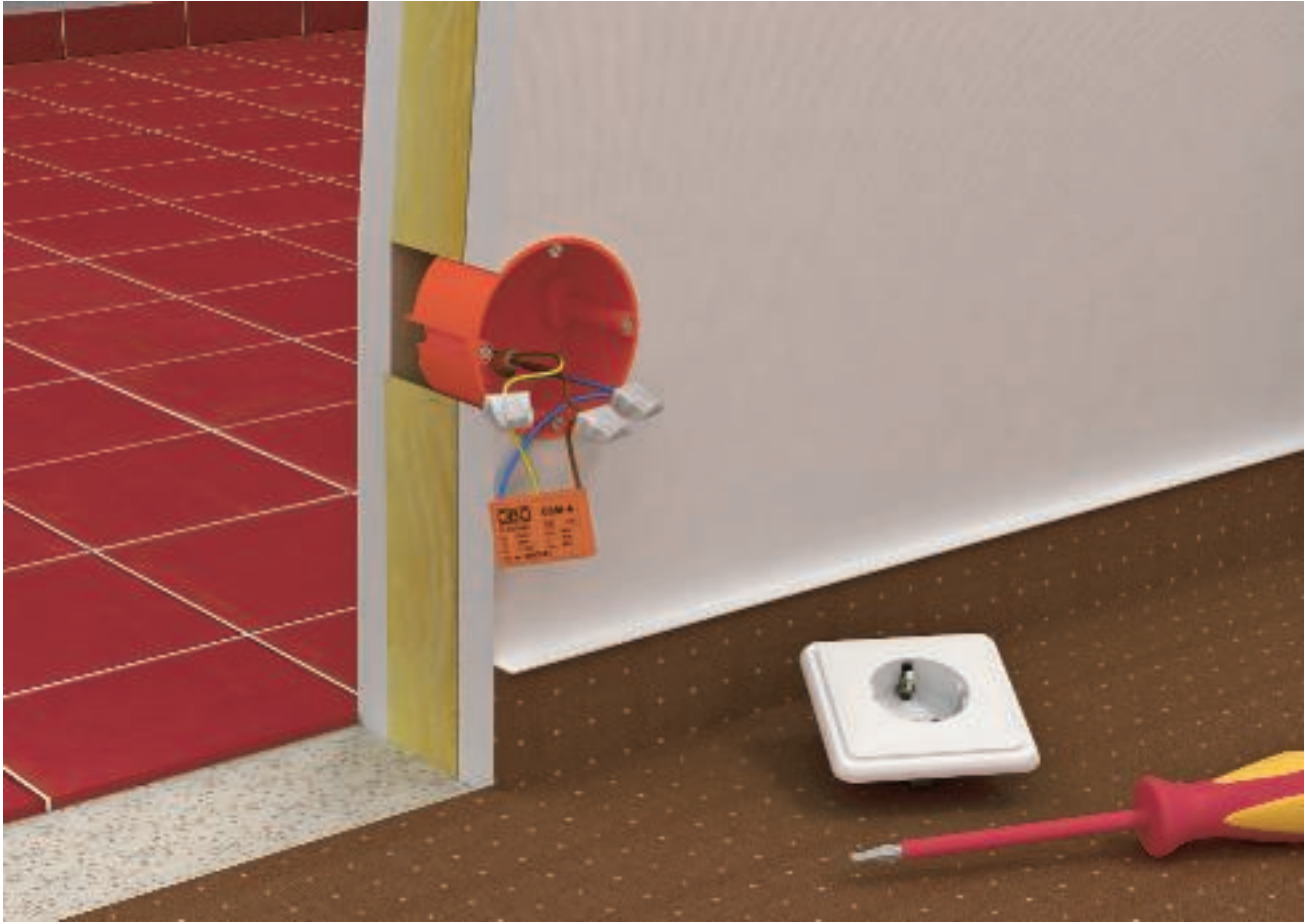





## Surge protection energy technology, arrester, type 3

	Fine power protection	Plug-in	210
		Fixed installation	212
		Series mounting	214

# Fine power protection, connectable



Surge protection/fine network protection, type 3, for Schuko systems

- VDE and GS tested and with child protection
- Combined protection for power supply with SAT, TV or telephone protection
- Incl. adapter cable (0.5 m)
- Telephone protection (TAE-D, RJ-D and ISDN-D) is DSL-compatible
- Function display on device

Application: Protection adapter directly on end consumer.

## FineController for protective contact socket



Type	Country version	Colour	Pack. pcs	Weight kg/100 pcs.	Item No.
<b>FC-D</b>	EN	Pure white	1	12.000	<b>5092 80 0</b>

/pc.

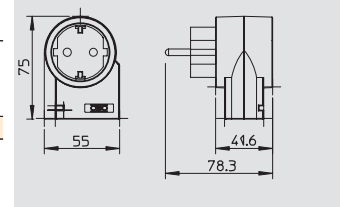

## FineController for video, TV and HiFi systems



Type	Country version	Colour	Pack. pcs	Weight kg/100 pcs.	Item No.
<b>FC-TV-D</b>	EN	Pure white	1	18.000	<b>5092 80 8</b>

/pc.

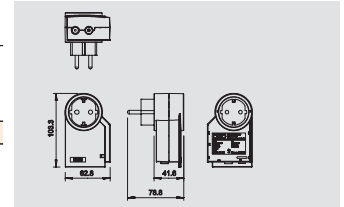

## FineController for SAT systems and receivers



Type	Country version	Colour	Pack. pcs	Weight kg/100 pcs.	Item No.
<b>FC-SAT-D</b>	EN	Pure white	1	18.000	<b>5092 81 6</b>

/pc.

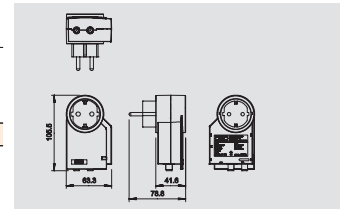

## FineController for telephone systems and terminals



Type	Country version	Colour	Pack. pcs	Weight kg/100 pcs.	Item No.
<b>FC-TAE-D</b>	EN	Pure white	1	18.000	<b>5092 82 4</b>

/pc.

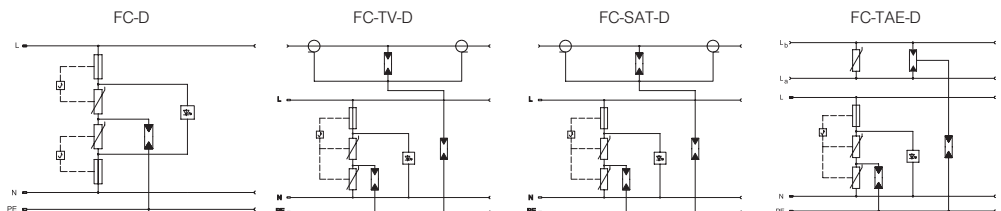
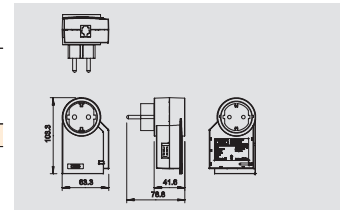

Nominal voltage	$U_N$	V	230	230	230	230
Max. continuous operating voltage	$U_C$	V	275	275	275	275
SPD to EN 61643-11			Type 3	Type 3	Type 3	Type 3
SPD to IEC 61643-11			class III	class III	class III	class III
Lightning protection Zone LPZ			2→3	2→3	2→3	2→3
Nominal discharge current (8/20)	$I_n$	kA	3	3	3	3
Protection level (L-N)		kV	< 1,2	< 1,2	< 1,2	< 1,2
Protection level (N-PE)		kV	< 1,5	< 1,5	< 1,5	< 1,5
Maximum back-up fuse		A	16	16	16	16
Response time	$t_a$	ns	<25	<25	<25	<25
<b>Item No.</b>			<b>5092 80 0</b>	<b>5092 80 8</b>	<b>5092 81 6</b>	<b>5092 82 4</b>



- Surge protection/fine network protection, type 3, for Schuko systems
- VDE and GS tested and with child protection
  - Combined protection for power supply with SAT, TV or telephone protection
  - Incl. adapter cable (0.5 m)
  - Telephone protection (TAE-D, RJ-D and ISDN-D) is DSL-compatible
  - Function display on device
- Application: Protection adapter directly on end consumer.

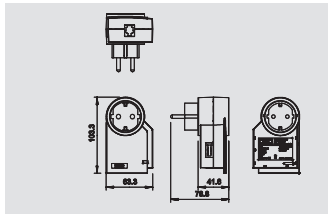

### FineController for ISDN telephone systems and terminals

Type	Country version	Colour	Pack. pcs	Weight kg/100 pcs.	Item No.
<b>FC-ISDN-D</b>	EN	Pure white	1	18.000	<b>5092 81 2</b>

/pc.

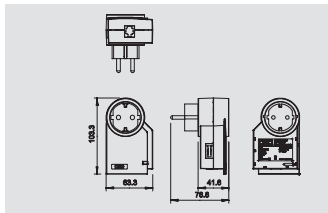

### FineController for telephone systems with RJ11

Type	Country version	Colour	Pack. pcs	Weight kg/100 pcs.	Item No.
<b>FC-RJ-D</b>	EN	Pure white	1	18.000	<b>5092 82 8</b>

/pc.

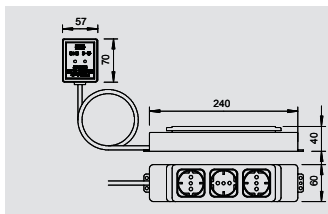

### Fine power protection / socket bar

Type	Country version	Colour	Connection cable length m	Pack. pcs	Weight kg/100 pcs.	Item No.
<b>CNS 3-D-D</b>	EN	Black	2	1	65.000	<b>5092 70 1</b>

/pc.

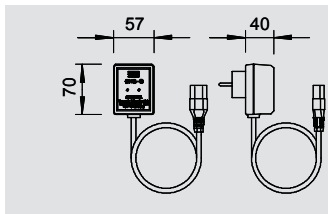

### Fine power protection / adapter with cold device connector

Type	Country version	Colour	Connection cable length m	Pack. pcs	Weight kg/100 pcs.	Item No.
<b>CNS-D-D</b>	EN	Light grey	1.5	1	30.000	<b>5092 60 4</b>

/pc.

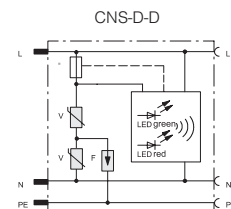
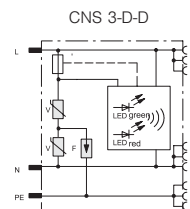
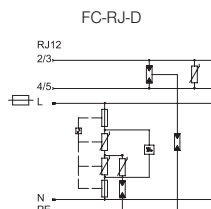
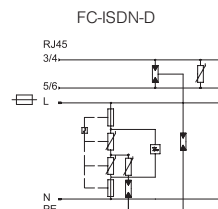

Nominal voltage	$U_{Nl}$	V	230	230	230	230		
Max. continuous operating voltage	$U_c$	V	275	275	255	255		
SPD to EN 61643-11			Type 3	Type 3	Type 3	Type 3		
SPD to IEC 61643-11			class III	class III	class III	class III		
Lightning protection Zone LPZ			2-3	2-3	2-3	2-3		
Nominal discharge current (8/20)	$I_n$	kA	3	3	2.5	2.5		
Protection level (L-N)		kV	< 1,2	< 1,2	< 1,0	< 1,0		
Protection level (N-PE)		kV	< 1,5	< 1,5	< 1,5	< 1,5		
Maximum back-up fuse		A	16	16	16	16		
Response time	$t_a$	ns	<25	<25	<25	<25		
<b>Item No.</b>			<b>5092 81 2</b>	<b>5092 82 8</b>	<b>5092 70 1</b>	<b>5092 60 4</b>		



# Fine power protection, fixed installation



Surge protection/fine network protection, type 3

- ÜSM-A with acoustic defect message
- Y connection
- Small dimensions
- ÜSM-A-4 and TW with bracket and partition function for installation in mounting boxes

Application: Can be used in any installation system.



## Fine power protection for all installation systems

Type	Signalling on device	Version	Pack. pcs	Weight kg/100 pcs.	Item No.
ÜSM-A	Audible	Acoustic function display	1	1.500	5092 45 1
ÜSM-A-150	Audible	Compact shape	1	1.500	5092 46 6

/pc.

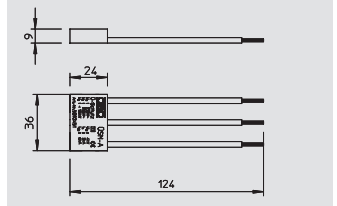

## Fine power protection for through wiring

Type	Signalling on device	Version	Pack. pcs	Weight kg/100 pcs.	Item No.
ÜSM-A-2	Audible	V connection	1	2.200	5092 46 0

/pc.

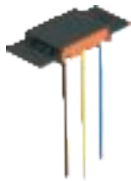
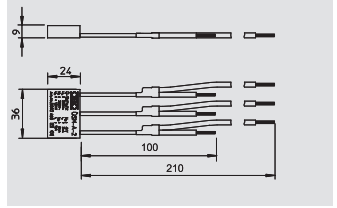

## Fine power protection with holder for GB2 and GB3 mounting boxes

Type	Signalling on device	Version	Pack. pcs	Weight kg/100 pcs.	Item No.
ÜSM-A-4	Audible	Incl. holder with partition function	1	2.000	5092 47 2

/pc.

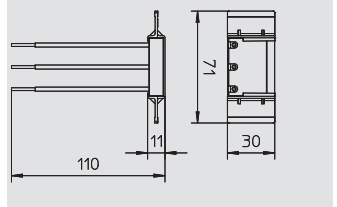

## Holder for installation in GB2 and GB3 mounting boxes

Type	Version	Pack. pcs	Weight kg/100 pcs.	Item No.
ÜSM-A-TW	Holder with partition function	1	0.500	5092 47 0

/pc.

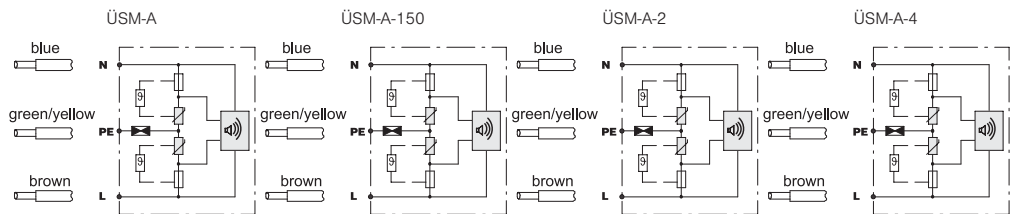
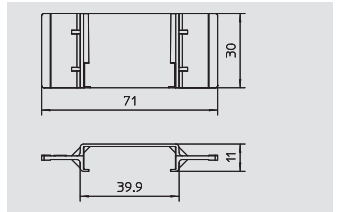

Nominal voltage	$U_N$	V	230	230	230	230
Max. continuous operating voltage	$U_C$	V	255	150	255	255
SPD to EN 61643-11			Type 3	Type 3	Type 3	Type 3
SPD to IEC 61643-11			class III	class III	class III	class III
Lightning protection Zone LPZ			2-3	2-3	2-3	2-3
Nominal discharge current (8/20)	$I_n$	kA	3	3	3	3
Protection level (L-N)		kV	< 1,3	< 1,3	< 1,3	< 1,3
Protection level (N-PE)		kV	< 1,5	< 1,5	< 1,5	< 1,5
Maximum back-up fuse		A	16	16	16	16
Response time	$t_A$	ns	< 25	< 25	< 25	< 25
Temperature range	$\vartheta$	°C	-15 - +60	-15 - +60	-15 - +60	-15 - +60
Maximum discharge current	$I_{max}$	kA	6	6	6	6
Rated current	$I_l$	A	16	16	16	16
<b>Item No.</b>			<b>5092 45 1</b>	<b>5092 46 6</b>	<b>5092 46 0</b>	<b>5092 47 2</b>



# Fine power protection, fixed installation

Surge protection/fine network protection, type 3

- ÜSM-A with acoustic defect message
- Y connection
- Small dimensions
- ÜSM-A-4 and TW with bracket and partition function for installation in mounting boxes

Application: Can be used in any installation system.

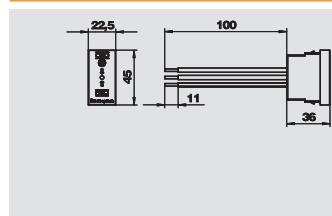
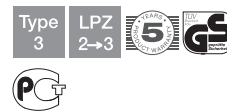

## Fine power protection / dado duct installation Modul 45

Type	Colour	Signalling on device	Pack. pcs	Weight kg/100 pcs.	Item No.
ÜSS 45-O-RW	Pure white	Visual	1	2.410	6117 47 3
ÜSS 45-O-ALU	Aluminium painted	Visual	1	2.410	6117 47 5

/pc.

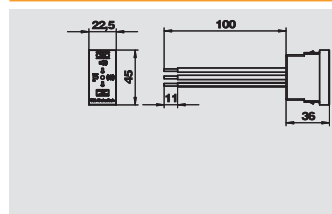

## Fine power protection / dado duct installation Modul 45

Type	Colour	Signalling on device	Pack. pcs	Weight kg/100 pcs.	Item No.
ÜSS 45-A-RW	Pure white	Audible	1	2.800	6117 46 5
ÜSS 45-A-ALU	Aluminium painted	Audible	1	2.800	6117 46 7

/pc.



Surge protection, arrester, type 3

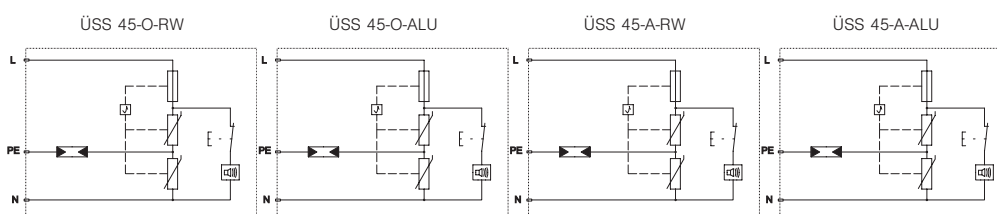

			ÜSS 45-O-RW	ÜSS 45-O-ALU	ÜSS 45-A-RW	ÜSS 45-A-ALU
Nominal voltage	$U_N$	V	230	230	230	230
Max. continuous operating voltage	$U_C$	V	255	255	255	255
SPD to EN 61643-11			Type 3	Type 3	Type 3	Type 3
SPD to IEC 61643-11			class III	class III	class III	class III
Lightning protection Zone LPZ			2→3	2→3	2→3	2→3
Nominal discharge current (8/20)	$I_n$	kA	2.5	2.5	2.5	2.5
Protection level (L-N)		kV	< 1,5	< 1,5	< 1,5	< 1,5
Protection level (N-PE)		kV	< 1,5	< 1,5	< 1,5	< 1,5
Maximum back-up fuse		A	16	16	16	16
Response time	$t_A$	ns	25	25	25	25
Temperature range	$\vartheta$	°C	-25 - +45	-25 - +45	-25 - +45	-25 - +45
<b>Item No.</b>			<b>6117 47 3</b>	<b>6117 47 5</b>	<b>6117 46 5</b>	<b>6117 46 7</b>

Always indicate the item number when ordering.

# Fine power protection, series installation



Surge protection device, fine protection type 3 for distributor installation

- Suitable for DC and AC voltage systems
- With visual function display
- With installation-friendly, screwless connection terminals
- In a space-saving 17.5 mm grid
- Y connection

Application: Universal use on 35 mm U-rail in every normal commercially available distribution housing.



## MCR protection for 2-pin for power supply, 12 V

Type	Version	U max AC V	U max DC V	Pack. pcs	Weight kg/100 pcs.	Item No.
<b>VF12-AC DC</b>	12 V version	13.5	18	1	9.000	<b>5097 45 3</b>

/pc.

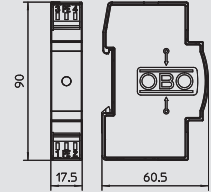

## MCR protection for 2-pin for power supply, 24 V

Type	Version	U max AC V	U max DC V	Pack. pcs	Weight kg/100 pcs.	Item No.
<b>VF24-AC/DC</b>	24 V version	34	46	1	8.000	<b>5097 60 7</b>

/pc.

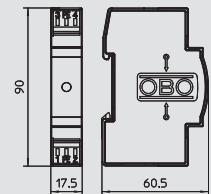

## MCR protection for 2-pin for power supply, 48 V

Type	Version	U max AC V	U max DC V	Pack. pcs	Weight kg/100 pcs.	Item No.
<b>VF48-AC/DC</b>	48 V version	60	80	1	8.000	<b>5097 61 5</b>

/pc.

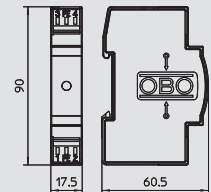

## MCR protection for 2-pin for power supply, 60 V

Type	Version	U max AC V	U max DC V	Pack. pcs	Weight kg/100 pcs.	Item No.
<b>VF60-AC/DC</b>	60 V version	80	110	1	8.000	<b>5097 62 3</b>

/pc.

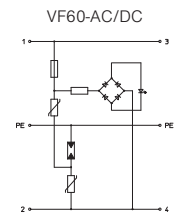
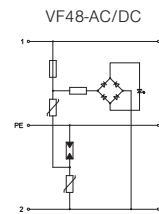
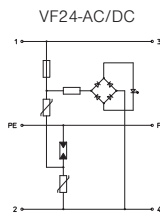
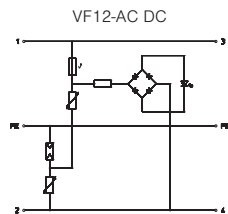
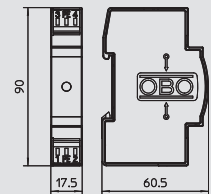

U max AC	U <sub>c</sub> AC	V	13.5	34	60	80
U max DC	U <sub>c</sub> DC	V	18	46	80	110
SPD to EN 61643-11			Type 3	Type 3	Type 3	Type 3
SPD to IEC 61643-11			class III	class III	class III	class III
Lightning protection Zone LPZ			2-3	2-3	2-3	2-3
Nominal discharge current (8/20)	I <sub>n</sub>	kA	0.7	0.7	0.7	0.7
Rated current	I <sub>L</sub>	A	20	20	20	20
Voltage protection level line-line		V	<110	<130	<220	<280
Voltage protection level line-earth		V	<1200	<1200	<1200	<1200
Response time	t <sub>A</sub>	ns	< 25	< 25	< 25	< 25
Temperature range	θ	°C	-40 - +80	-40 - +80	-40 - +80	-40 - +80
Degree of protection of enclosure			IP 20	IP 20	IP 20	IP 20
Division unit TE (17.5 mm)			1	1	1	1
Connection cross-section, rigid		mm <sup>2</sup>	0,14 - 2,5	0,14 - 2,5	0,14 - 2,5	0,14 - 2,5
Connection cross-section, multi-wire		mm <sup>2</sup>	0,14 - 2,5	0,14 - 2,5	0,14 - 2,5	0,14 - 2,5
Connection cross-section, flexible		mm <sup>2</sup>	0,14 - 2,5	0,14 - 2,5	0,14 - 2,5	0,14 - 2,5
<b>Item No.</b>			<b>5097 45 3</b>	<b>5097 60 7</b>	<b>5097 61 5</b>	<b>5097 62 3</b>



# Fine power protection, series installation

Surge protection device, fine protection type 3 for distributor installation

- Suitable for DC and AC voltage systems
- With visual function display
- With installation-friendly, screwless connection terminals
- In a space-saving 17.5 mm grid
- Y connection

Application: Universal use on 35 mm U-rail in every normal commercially available distribution housing.

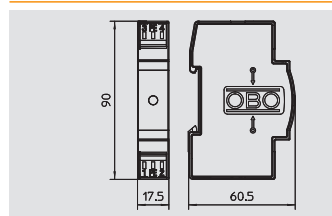

## MCR protection for 2-pin for power supply, 110 V

Type	Version	U max AC V	U max DC V	Pack. pcs	Weight kg/100 pcs.	Item No.
<b>VF110-AC DC</b>	110 V version	150	200	1	8.000	<b>5097 63 1</b>

/pc.

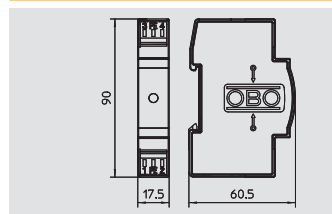

## MCR protection for 2-pin for power supply, 230 V

Type	Version	U max AC V	U max DC V	Pack. pcs	Weight kg/100 pcs.	Item No.
<b>VF230-AC/DC</b>	230 V version	255	350	1	8.000	<b>5097 65 0</b>

/pc.

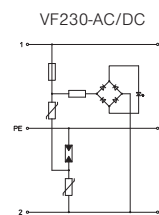
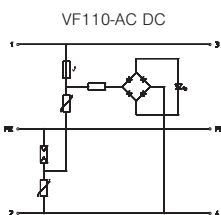

U max AC	U <sub>c</sub> AC	V	150	255
U max DC	U <sub>c</sub> DC	V	200	350
SPD to EN 61643-11			Type 3	Type 3
SPD to IEC 61643-11			class III	class III
Lightning protection Zone LPZ			2→3	2→3
Nominal discharge current (8/20)	I <sub>n</sub>	kA	2	2.5
Rated current	I <sub>L</sub>	A	20	20
Voltage protection level line-line		V	<500	<1000
Voltage protection level line-earth		V	<1400	<1400
Response time	t <sub>A</sub>	ns	<25	<25
Temperature range	θ	°C	-40 - +80	-40 - +80
Degree of protection of enclosure			IP 20	IP 20
Division unit TE (17.5 mm)			1	1
Connection cross-section, rigid		mm <sup>2</sup>	0,14 - 2,5	0,14 - 2,5
Connection cross-section, multi-wire		mm <sup>2</sup>	0,14 - 2,5	0,14 - 2,5
Connection cross-section, flexible		mm <sup>2</sup>	0,14 - 2,5	0,14 - 2,5
<b>Item No.</b>			<b>5097 63 1</b>	<b>5097 65 0</b>



# Fine power protection, series installation



Surge protection device, fine protection type 3 for distributor installation

- Suitable for DC and AC voltage systems
- With visual function display
- With installation-friendly, screwless connection terminals
- In a space-saving 17.5 mm grid
- Y connection

Application: Universal use on 35 mm U-rail in every normal commercially available distribution housing.



## MCR protection for 2-pin for power supply with remote signalling, 24 V AC/DC

Type	U max DC V	U max AC V	Pack. pcs	Weight kg/100 pcs.	Item No.
<b>VF24-AC/DC-FS</b>	46	34	1	6.620	<b>5097 82 0</b>

/pc.

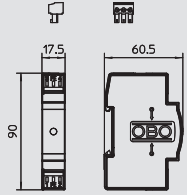

## MCR protection for 2-pin for power supply with remote signalling, 110 V AC/DC

Type	U max DC V	U max AC V	Pack. pcs	Weight kg/100 pcs.	Item No.
<b>VF110-AC DC-FS</b>	200	150	1	6.600	<b>5097 84 6</b>

/pc.

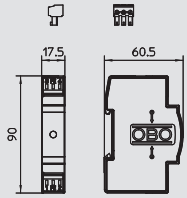

## MCR protection for 2-pin for power supply with remote signalling, 230 V AC

Type	U max DC V	U max AC V	Pack. pcs	Weight kg/100 pcs.	Item No.
<b>VF230-AC-FS</b>	—	255	1	6.910	<b>5097 85 8</b>

/pc.

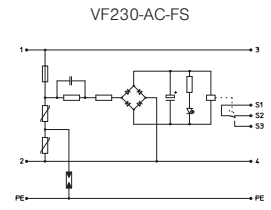
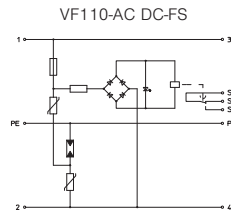
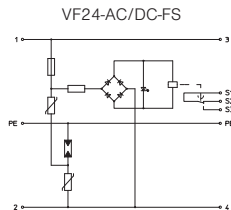
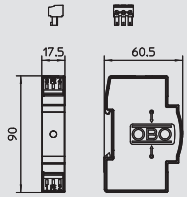

U max AC	U <sub>c</sub> AC	V	34	150	255
U max DC	U <sub>c</sub> DC	V	46	200	
SPD to EN 61643-11			Type 3	Type 3	Type 3
SPD to IEC 61643-11			class III	class III	class III
Lightning protection Zone LPZ			2→3	2→3	2→3
Nominal discharge current (8/20)	I <sub>n</sub>	kA	0.7	2	2.5
Rated current	I <sub>L</sub>	A	20	20	20
Voltage protection level line-line		V	<160	<500	<1060
Voltage protection level line-earth		V	<1200	<1300	<1400
Response time	t <sub>A</sub>	ns	< 25	< 25	< 25
Temperature range	θ	°C	-40 - +80	-40 - +80	-40 - +80
Degree of protection of enclosure			IP 20	IP 20	IP 20
Division unit TE (17.5 mm)			1	1	1
Connection cross-section, rigid		mm <sup>2</sup>	0,14 - 2,5	0,14 - 2,5	0,14 - 2,5
Connection cross-section, multi-wire		mm <sup>2</sup>	0,14 - 2,5	0,14 - 2,5	0,14 - 2,5
Connection cross-section, flexible		mm <sup>2</sup>	0,14 - 2,5	0,14 - 2,5	0,14 - 2,5
<b>Item No.</b>			<b>5097 82 0</b>	<b>5097 84 6</b>	<b>5097 85 8</b>





# Fine power protection, series installation

Type 3 surge protection/fine network protection with leak current-free remote signalling

- With remote signalling: potential-free NC contact for function monitoring
- With installation-friendly, screwless connection terminals
- In space-saving 17.5 mm grid
- Y circuit

Application: Universal use on 35 mm hat profile rails in any standard distributor housing.

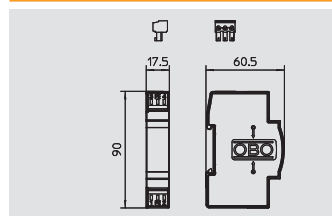

## MCR protection for 2-pin for power supply with leak current-free remote signalling, 24 V AC/DC

Type	U max AC V	U max DC V	Pack. pcs	Weight kg/100 pcs.	Item No.
<b>VF2-24-AC/DC-FS</b>	34	46	1	6.000	<b>5097 93 1</b>

/pc.

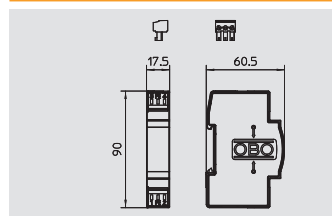

## MCR protection for 2-pin for power supply with leak current-free remote signalling, 110 V AC/DC

Type	U max AC V	U max DC V	Pack. pcs	Weight kg/100 pcs.	Item No.
<b>VF2-110-AC/DCFS</b>	150	200	1	6.000	<b>5097 93 5</b>

/pc.

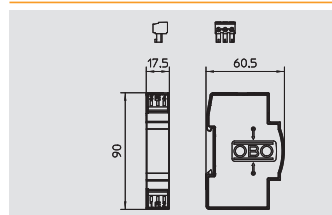

## MCR protection for 2-pin for power supply with leak current-free remote signalling, 230 V AC/DC

Type	U max AC V	U max DC V	Pack. pcs	Weight kg/100 pcs.	Item No.
<b>VF2-230-AC/DC-FS</b>	255	350	1	6.000	<b>5097 93 9</b>

/pc.



Surge protection, arrester, type 3

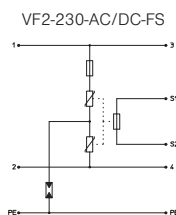
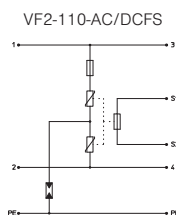
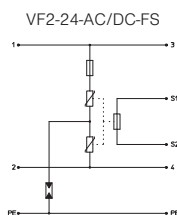

	VF2-24-AC/DC-FS	VF2-110-AC/DCFS	VF2-230-AC/DC-FS
U max AC	34	150	255
U max DC	46	200	350
SPD to EN 61643-11	Type 3	Type 3	Type 3
SPD to IEC 61643-11	class III	class III	class III
Lightning protection Zone LPZ	2-3	2-3	2-3
Nominal discharge current (8/20)	2.5	2.5	2.5
Rated current	20	20	20
Voltage protection level line-line	< 130	< 220	< 1000
Voltage protection level line-earth	< 1200	< 1200	< 1400
Response time	<25	<25	<25
Temperature range	-40 - +80	-40 - +80	-40 - +80
Degree of protection of enclosure	IP 20	IP 20	IP 20
Division unit TE (17.5 mm)	1	1	1
Connection cross-section, rigid	0,14 - 2,5	0,14 - 2,5	0,14 - 2,5
Connection cross-section, multi-wire	0,14 - 2,5	0,14 - 2,5	0,14 - 2,5
Connection cross-section, flexible	0,14 - 2,5	0,14 - 2,5	0,14 - 2,5
<b>Item No.</b>	<b>5097 93 1</b>	<b>5097 93 5</b>	<b>5097 93 9</b>



## Photovoltaic systems

	Photovoltaic systems	Lightning current and surge arrester, type 1+2, photovoltaic systems 600 V DC	220
		Lightning current and surge arrester, type 1+2, photovoltaic systems 900 V DC	221
		Surge arrester, type 2, photovoltaics 600 V DC	222
		Surge arrester, type 2, photovoltaics 1,000 V DC	223
	Photovoltaic system solution	Connection with MC4 connector with 2 / 3 MPP	224
		Connection with terminals, system solution for one-pole protection	226
		Connection with terminals	228
		Connection with MC4 connector	229
		Unequipped, without upper parts	230
		Photovoltaic upper parts	231
		Photovoltaic bases	232

# Lightning current and surge arrester, type 1+2, photovoltaic systems 600 V DC



Combination arrester, type 2, for photovoltaic systems

- Error-resistant Y circuit for use according to VDE 0100-712 (IEC 60364-7-712)
- For surge voltage protection equipotential bonding to VDE 0100-443 (IEC 60364-4-44)
- Arresting capacity to 40 kA (8/20) per pin
- Low DC protection level: < 2.6 kV (Voc max = 600 V DC)
- Arrester, connectable with thermodynamic cut-off unit and function display
- Encapsulated, non-blow out zinc oxide varistor arrester for use in distributor housings

Application: PV systems with separated insulated lightning protection system



## Complete photovoltaic block V50, 600 V DC

Type	U max DC V	Version	Pack. pcs	Weight kg/100 pcs.	Item No.
<b>V50-B+C 3-PH600</b>	600	3-pole for PV systems	1	41.000	<b>5093 62 3</b>

/pc.

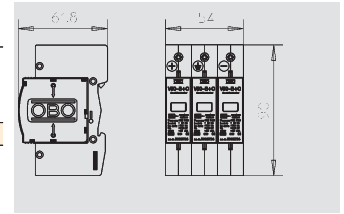

## Complete photovoltaic block V50, 600 V DC with IR

Type	U max DC V	Version	Pack. pcs	Weight kg/100 pcs.	Item No.
<b>V50-B+C 3PHFS600</b>	600	3-pole for PV systems with FS	1	49.600	<b>5093 62 5</b>

/pc.

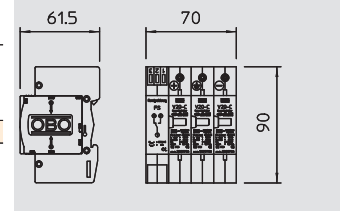

## Complete photovoltaic block V50, 600 V DC

Type	U max DC V	Version	Pack. pcs	Weight kg/100 pcs.	Item No.
<b>V50-B+C 2-PH600</b>	600	2-pole for earthed PV systems	1	30.000	<b>5093 62 8</b>

/pc.

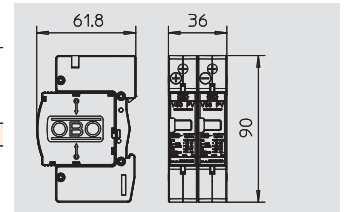

## Complete photovoltaic block V50, 600 V DC with IR

Type	U max DC V	Version	Pack. pcs	Weight kg/100 pcs.	Item No.
<b>V50-B+C 2PHFS600</b>	600	2-pole for earthed PV systems with FS	1	24.400	<b>5093 62 9</b>

/pc.

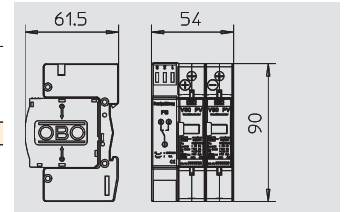

V50-B+C 3-PH600

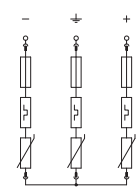

V50-B+C 3PHFS600

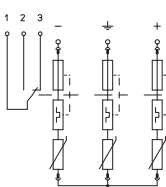

V50-B+C 2-PH600

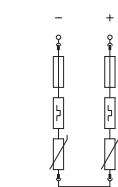

V50-B+C 2PHFS600

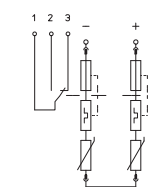

U max DC	U <sub>c</sub> DC	V	600	600	600	600
SPD to EN 61643-11			Type 1+2	Type 1+2	Type 1+2	Type 1+2
Lightning protection Zone LPZ			0-2	0-2	0-2	0-2
Impulse discharge current (10/350)	I <sub>imp</sub>	kA	12,5	12,5	12,5	12,5
Nominal discharge current (8/20)	I <sub>n</sub>	kA	30	30	30	30
Maximum discharge current	I <sub>max</sub>	kA	50	50	50	50
Voltage protection level	U <sub>p</sub>	kV	< 2,6	< 2,6	< 2,6	< 2,6
Response time	t <sub>A</sub>	ns	< 25	< 25	< 25	< 25
Temperature range	θ	°C	-40 - +80	-40 - +80	-40 - +80	-40 - +80
Degree of protection of enclosure			IP 20	IP 20	IP 20	IP 20
Division unit TE (17.5 mm)			3	4	2	3
Connection cross-section, rigid		mm <sup>2</sup>	2,5 - 35	2,5 - 35	2,5 - 35	2,5 - 35
Connection cross-section, multi-wire		mm <sup>2</sup>	2,5 - 35	2,5 - 35	2,5 - 35	2,5 - 35
Connection cross-section, flexible		mm <sup>2</sup>	2,5 - 25	2,5 - 25	2,5 - 25	2,5 - 25
<b>Item No.</b>			<b>5093 62 3</b>	<b>5093 62 5</b>	<b>5093 62 8</b>	<b>5093 62 9</b>



# Lightning current and surge arrester, type 1+2, photovoltaic systems 900 V DC

Combination arrester, type 2, for photovoltaic systems



- Error-resistant Y circuit for use according to VDE 0100-712 (IEC 60364-7-712)
- For surge voltage protection equipotential bonding to VDE 0100-443 (IEC 60364-4-44)
- Arresting capacity to 7 kA (10/350) and 50 kA (8/20) per pin
- Low DC protection level: < 3.0 kV (Voc max = 900 V DC)
- Arrester, connectable with thermodynamic cut-off unit and function display
- Encapsulated, non-extinguishing zinc oxide varistor arrester for use in distributor housings

Application: PV systems with separated insulated lightning protection system

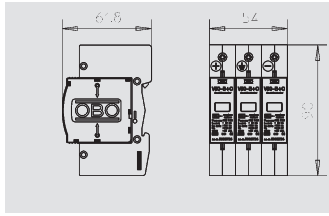

## Complete photovoltaic block V25, 900 V DC

Type	U max DC V	Version	Pack. pcs	Weight kg/100 pcs.	Item No.
V25-B+C 3-PH900	900	3-pole for PV systems	1	42.200	5097 44 7

/pc.

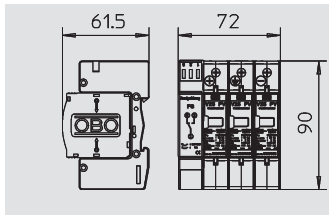

## Complete photovoltaic block V25, 900 V DC with IR

Type	U max DC V	Version	Pack. pcs	Weight kg/100 pcs.	Item No.
V25-B+C 3PHFS900	900	3-pole for PV systems with FS	1	53.500	5097 44 8

/pc.

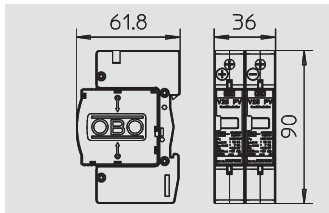

## Complete photovoltaic block V25, 900 V DC

Type	U max DC V	Version	Pack. pcs	Weight kg/100 pcs.	Item No.
V25-B+C 2-PH900	900	2-pole for earthed PV systems	1	30.800	5097 45 7

/pc.

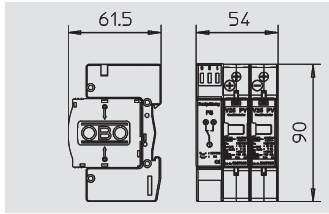

## Complete photovoltaic block V25, 900 V DC with IR

Type	U max DC V	Version	Pack. pcs	Weight kg/100 pcs.	Item No.
V25-B+C 2PHFS900	900	2-pole for earthed PV systems with FS	1	37.000	5097 45 8

/pc.



V25-B+C 3-PH900

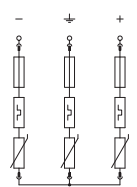

V25-B+C 3PHFS900

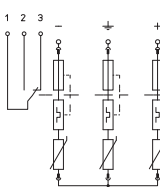

V25-B+C 2-PH900

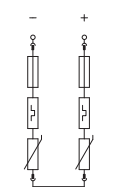

V25-B+C 2PHFS900

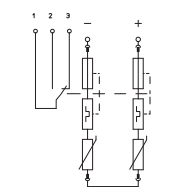

U max DC SPD to EN 61643-11 Lightning protection Zone LPZ	U <sub>c</sub> DC V	900	900	900	900
Impulse discharge current (10/350)	I <sub>imp</sub> kA	7	7	7	7
Nominal discharge current (8/20)	I <sub>n</sub> kA	30	30	30	30
Maximum discharge current	I <sub>max</sub> kA	50	50	50	50
Voltage protection level	U <sub>p</sub> kV	< 3,0	< 3,0	< 3,0	< 3,0
Response time	t <sub>A</sub> ns	< 25	< 25	< 25	< 25
Temperature range	θ °C	-40 - +80	-40 - +80	-40 - +80	-40 - +80
Degree of protection of enclosure		IP 20	IP 20	IP 20	IP 20
Division unit TE (17.5 mm)		3	4	2	3
Connection cross-section, rigid	mm <sup>2</sup>	2,5 - 35	2,5 - 35	2,5 - 35	2,5 - 35
Connection cross-section, multi-wire	mm <sup>2</sup>	2,5 - 35	2,5 - 35	2,5 - 35	2,5 - 35
Connection cross-section, flexible	mm <sup>2</sup>	2,5 - 25	2,5 - 25	2,5 - 25	2,5 - 25
<b>Item No.</b>		<b>5097 44 7</b>	<b>5097 44 8</b>	<b>5097 45 7</b>	<b>5097 45 8</b>



# Surge arrester, type 2, photovoltaics 600 V DC



Surge arrester, type 2, for photovoltaic systems

- Error-resistant Y circuit for use according to VDE 0100-712 (IEC 60364-7-712)
- For surge voltage protection equipotential bonding to VDE 0100-443 (IEC 60364-4-44)
- Arresting capacity to 40 kA (8/20) per pin
- Low DC protection level: < 2.6 kV (Voc max = 600 V DC)
- Arrester, connectable with thermodynamic cut-off unit and function display
- Encapsulated, non-extinguishing zinc oxide varistor arrester for use in distributor housings

Application: PV systems with or without separated insulated lightning protection system



## Complete photovoltaic block V20, 600 V DC

Type	U max DC V	Version	Pack. pcs	Weight kg/100 pcs.	Item No.
V20-C 3PH-600	600	3-pole for PV systems	1	33.500	5094 60 5

/pc.

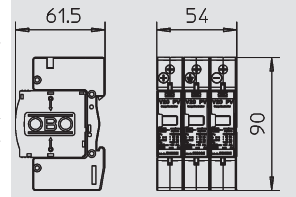

## Complete photovoltaic block V20, 600 V DC with IR

Type	U max DC V	Version	Pack. pcs	Weight kg/100 pcs.	Item No.
V20-C 3PHFS-600	600	3-pole for PV systems with FS	1	41.500	5094 57 6

/pc.

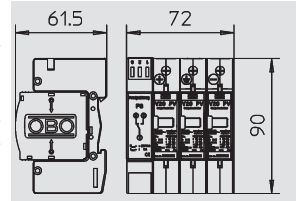

## Complete photovoltaic block V20, 600 V DC

Type	U max DC V	Version	Pack. pcs	Weight kg/100 pcs.	Item No.
V20-C 2PH-600	600	2-pole for earthed PV systems	1	25.000	5094 61 3

/pc.

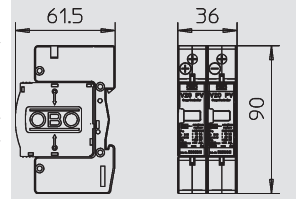

## Complete photovoltaic block V20, 600 V DC with IR

Type	U max DC V	Version	Pack. pcs	Weight kg/100 pcs.	Item No.
V20-C 2PHFS-600	600	2-pole for earthed PV systems with FS	1	29.000	5094 57 2

/pc.

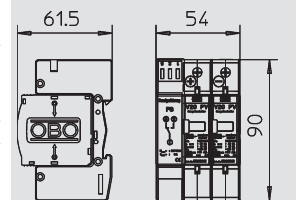

V20-C 3PH-600

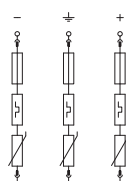

V20-C 3PHFS-600

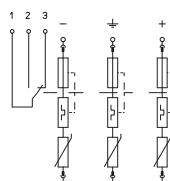

V20-C 2PH-600

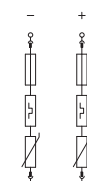

V20-C 2PHFS-600

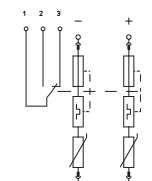

U max DC	U <sub>c</sub> DC V	600	600	600	600
SPD to EN 61643-11		Type 2	Type 2	Type 2	Type 2
Lightning protection Zone LPZ		1-2	1-2	1-2	1-2
Nominal discharge current (8/20)	I <sub>n</sub> kA	20	20	20	20
Maximum discharge current	I <sub>max</sub> kA	40	40	40	40
Voltage protection level	U <sub>p</sub> kV	< 2,6	< 2,6	< 2,6	< 2,6
Response time	t <sub>A</sub> ns	< 25	< 25	< 25	< 25
Temperature range	θ °C	-40 - +80	-40 - +80	-40 - +80	-40 - +80
Degree of protection of enclosure		IP 20	IP 20	IP 20	IP 20
Division unit TE (17.5 mm)		3	4	2	3
Connection cross-section, rigid	mm <sup>2</sup>	2,5 - 35	2,5 - 35	2,5 - 35	2,5 - 35
Connection cross-section, multi-wire	mm <sup>2</sup>	2,5 - 35	2,5 - 35	2,5 - 35	2,5 - 35
Connection cross-section, flexible	mm <sup>2</sup>	2,5 - 25	2,5 - 25	2,5 - 25	2,5 - 25
<b>Item No.</b>		<b>5094 60 5</b>	<b>5094 57 6</b>	<b>5094 61 3</b>	<b>5094 57 2</b>



# Surge arrester, type 2, photovoltaics 1000 V DC

Surge arrester, type 2, for photovoltaic systems

- Error-resistant Y circuit for use according to VDE 0100-712 (IEC 60364-7-712)
- For surge voltage protection equipotential bonding to VDE 0100-443 (IEC 60364-4-44)
- Arresting capacity to 40 kA (8/20) per pin
- Low DC protection level: < 4.0 kV (Voc max = 1,000 V DC)
- Arrester, connectable with thermodynamic cut-off unit and function display
- Encapsulated, non-extinguishing zinc oxide varistor arrester for use in distributor housings



Application: PV systems with or without separated insulated lightning protection system

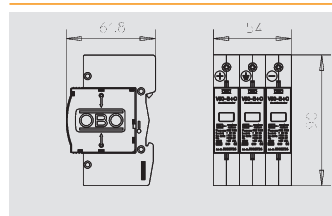

## Complete photovoltaic block V20, 1000 V DC

Type	U max DC V	Version	Pack. pcs	Weight kg/100 pcs.	Item No.
V20-C 3-PH-1000	1000	3-pole for PV systems	1	36.500	5094 60 8

/pc.

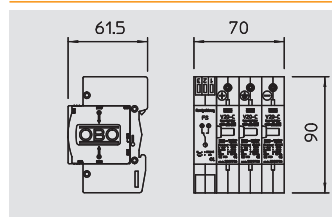

## Complete photovoltaic block V20, 1000 V DC with IR

Type	U max DC V	Version	Pack. pcs	Weight kg/100 pcs.	Item No.
V20-C 3PHFS-1000	1000	3-pole for PV systems with FS	1	44.500	5094 57 4

/pc.

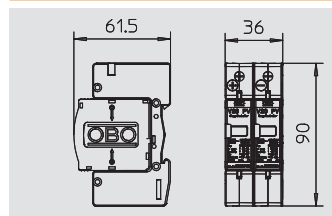

## Complete photovoltaic block V20, 1000 V DC

Type	U max DC V	Version	Pack. pcs	Weight kg/100 pcs.	Item No.
V20-C 2-PH-1000	1000	2-pole for earthed PV systems	1	27.000	5094 61 7

/pc.

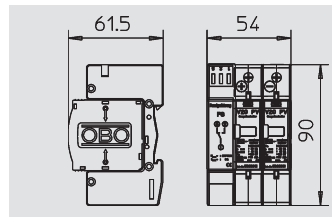

## Complete photovoltaic block V20, 1000 V DC with IR

Type	U max DC V	Version	Pack. pcs	Weight kg/100 pcs.	Item No.
V20-C 2PHFS-1000	1000	2-pole for earthed PV systems with FS	1	31.000	5094 61 5

/pc.



Surge protection, photovoltaics



02\_TBS\_Masterkatalog\_Länder\_2012 / en / 29/05/2012 (LLEExport\_014333) / 29/05/2012

V20-C 3-PH-1000

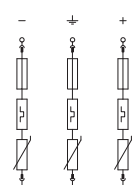

V20-C 3PHFS-1000

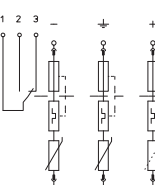

V20-C 2-PH-1000

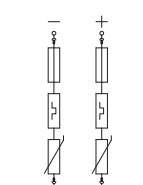

V20-C 2PHFS-1000

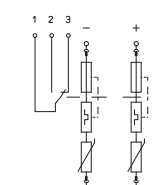

U max DC SPD to EN 61643-11 Lightning protection Zone LPZ Nominal discharge current (8/20) Maximum discharge current Voltage protection level Response time Temperature range Degree of protection of enclosure Division unit TE (17.5 mm) Connection cross-section, rigid Connection cross-section, multi-wire Connection cross-section, flexible Item No.	U <sub>c</sub> DC V																	
	1000	Type 2	1→2	20	40	< 4,0	< 25	-40 - +80	IP 20	3	2,5 - 35	2,5 - 35	2,5 - 25	5094 60 8				
	1000	Type 2	1→2	20	40	< 4,0	< 25	-40 - +80	IP 20	4	2,5 - 35	2,5 - 35	2,5 - 25	5094 57 4				
	1000	Type 2	1→2	20	40	< 4,0	< 25	-40 - +80	IP 20	2	2,5 - 35	2,5 - 35	2,5 - 25	5094 61 7				
	1000	Type 2	1→2	20	40	< 4,0	< 25	-40 - +80	IP 20	3	2,5 - 35	2,5 - 35	2,5 - 25	5094 61 5				

Always indicate the item number when ordering.

# Photovoltaic system solution for inverter with multiple MPP trackers

Type	LPZ	Type	LPZ
2	1→2	1+2	0→2



System solution for PV converters with 2 / 3 separate MPP trackers

- Error-resistant Y circuit with 3 varistors for use according to VDE 0100-712
- Low DC protection level: < 4.0 kV (Voc max = 1,000 V DC with V20-C/0-500PV)
- Two PV string inputs on each MPP-WR input, I<sub>max</sub> = 15 A DC per PV string
- DC connection compatible with MC4 plug connector (Series: PV-AD...P 4/6)
- Arrestor, connectable with dynamic cut-off unit and visual function display
- Encapsulated, non-extinguishing zinc oxide varistor for use in distributor housings
- Polycarbonate housing, weatherproof for outdoor use. Application: PV system for DC protection of the inverter

Additional measures may be necessary if there is the risk of condensation formation.

## Photovoltaic housing for inverter with 2 MPP trackers, type 1+2, 900 V DC



Type	U <sub>max</sub> DC V	Version	Pack. pcs	Weight kg/100 pcs.	Item No.
<b>VG-BC DCPH900-21</b>	900	Protection for two separate MPP trackers	1	431.000	<b>5088 62 5</b>

/pc.

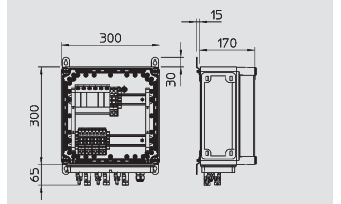

## Photovoltaic housing for inverter with 3 MPP trackers, type 1+2, 900 V DC



Type	U <sub>max</sub> DC V	Version	Pack. pcs	Weight kg/100 pcs.	Item No.
<b>VG-BC DCPH900-31</b>	900	Protection for three separate MPP trackers	1	542.000	<b>5088 62 9</b>

/pc.

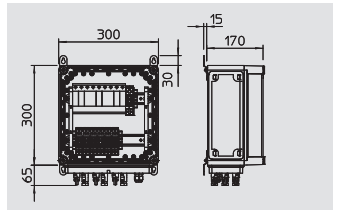

## Photovoltaic housing for inverter with 2 MPP trackers, type 2, 1000 V DC



Type	U <sub>max</sub> DC V	Version	Pack. pcs	Weight kg/100 pcs.	Item No.
<b>VG-C DCPH1000-21</b>	1000	Protection for two separate MPP trackers	1	419.800	<b>5088 64 6</b>

/pc.

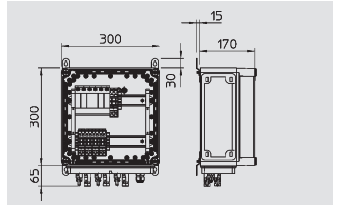

## Photovoltaic housing for inverter with 3 MPP trackers, type 2, 1000 V DC



Type	U <sub>max</sub> DC V	Version	Pack. pcs	Weight kg/100 pcs.	Item No.
<b>VG-C DCPH1000-31</b>	1000	Protection for three separate MPP trackers	1	524.500	<b>5088 64 8</b>

/pc.

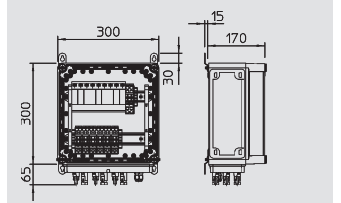

VG-BC DCPH900-21

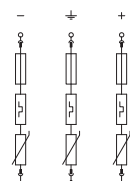

VG-BC DCPH900-31

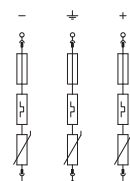

VG-C DCPH1000-21

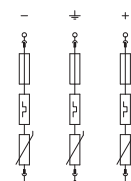

VG-C DCPH1000-31

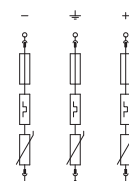

U <sub>max</sub> DC	U <sub>c</sub> DC V	900	900	1000	1000
SPD to EN 61643-11		Type 1+2	Type 1+2	Type 2	Type 2
Lightning protection Zone LPZ		0→2	0→2	1→2	1→2
Impulse discharge current (10/350)	I <sub>imp</sub> kA	7	7	20	20
Nominal discharge current (8/20)	I <sub>n</sub> kA	30	30	40	40
Maximum discharge current	I <sub>max</sub> kA	60	60	40	40
Voltage protection level	U <sub>p</sub> kV	< 3,0	< 3,0	< 4,0	< 4,0
Response time	t <sub>A</sub> ns	< 25	< 25	< 25	< 25
Temperature range	θ °C	-40 - +80	-40 - +80	-40 - +80	-40 - +80
Degree of protection of enclosure		IP65	IP65	IP65	IP65
<b>Item No.</b>		<b>5088 62 5</b>	<b>5088 62 9</b>	<b>5088 64 6</b>	<b>5088 64 8</b>





# Photovoltaic system solution with fuse holder

System solution for photovoltaic systems with connection terminals and entry set

- Error-resistant Y circuit with 3 varistors for use according to VDE 0100-712
- Low DC protection level: < 4.0 kV (Voc max = 1,000 V DC with V20-C/0-500PV)
- 5 parallel connection terminals to 6 mm<sup>2</sup> per polarity (+ and -)
- V-Tec entries set included
- Arrestor, connectable with thermodynamic cut-off unit and visual function display
- Encapsulated, non-extinguishing zinc oxide varistor arrestor for use in distributor housings
- Polycarbonate housing, weatherproof for outdoor use.



Note: 5 PV strings can be switched in parallel on the terminals. The technical data (string voltage, etc.) and the conditions of the converter (number of MPP trackers) must be taken into account.

Additional measures may be necessary if there is the risk of condensation formation.

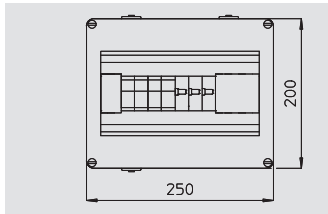

## Photovoltaic housing with 4 fuses

Type	U max DC V	Version	Pack. pcs	Weight kg/100 pcs.	Item No.
<b>VG-C DCPH1000-4S</b>	1000	Type 2 in housing with 4 PV fuses	1	200.000	<b>5088 65 1</b>

/pc.

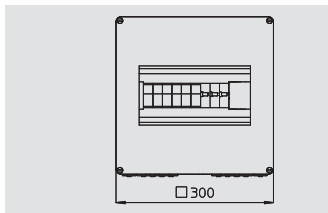

## Photovoltaic housing with 6 fuses

Type	U max DC V	Version	Pack. pcs	Weight kg/100 pcs.	Item No.
<b>VG-C DCPH1000-6S</b>	1000	Type 2 in housing with 6 PV fuses	1	370.000	<b>5088 65 2</b>

/pc.



VG-C DCPH1000-4S

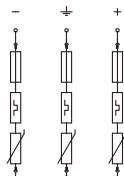

VG-C DCPH1000-6S

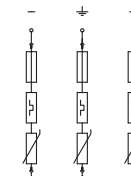

U max DC	U <sub>c</sub> DC	V	1000	1000
SPD to EN 61643-11			Type 2	Type 2
Lightning protection Zone LPZ			1→2	1→2
Nominal discharge current (8/20)	I <sub>n</sub>	kA	20	20
Maximum discharge current	I <sub>m</sub>	kA	40	40
Voltage protection level	U <sub>p</sub> <sup>max</sup>	kV	< 4,0	< 4,0
Response time	t <sub>A</sub>	ns	< 25	< 25
Connection cross-section, rigid		mm <sup>2</sup>	0,5 - 6	0,5 - 10
Connection cross-section, flexible		mm <sup>2</sup>	0,5 - 6	0,5 - 10
Temperature range	θ	°C	-40 - +80	-40 - +80
Degree of protection of enclosure			IP 65	IP 65
<b>Item No.</b>			<b>5088 65 1</b>	<b>5088 65 2</b>



# Photovoltaic system solution with connection terminals

Type 1+2	Type 2	LPZ 0→1	LPZ 1→2
----------	--------	---------	---------



System solution for photovoltaic systems with connection terminals

- Error-resistant Y circuit with 3 varistors for use according to VDE 0100-712 (IEC 60364-7-712)
- Low DC protection level: < 4.0 kV (Voc max = 1.000 V DC with V20-C/0-500PV)
- Low DC protection level: < 3.0 kV (Voc max = 900 V DC with V25-B+C/0-450PV)
- Low DC protection level: < 2.6 kV (Voc max = 600 V DC with V50-B+C/0-300PV)
- 6 parallel connection terminals up to 6 mm<sup>2</sup> for each polarity (+ and -)
- Pre-mounted in IP65 housing

Note: 5 PV strings can be switched in parallel on the terminals. The technical data (string voltage, etc.) and the conditions of the inverter (number of MPP trackers) must be taken into account.



## Photovoltaic housing with connection terminals, type 1+2, 600 V DC

Type	U max DC V	Version	Pack. pcs	Weight kg/100 pcs.	Item No.
<b>VG-BC DCPH-MS600</b>	600	Type 1+2 in housing with terminals	1	159.000	<b>5088 69 3</b>

/pc.

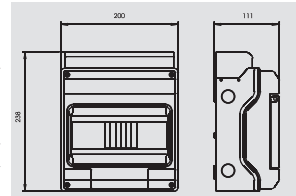

## Photovoltaic housing with connection terminals, type 1+2, 900 V DC

Type	U max DC V	Version	Pack. pcs	Weight kg/100 pcs.	Item No.
<b>VG-BC DCPH-MS900</b>	900	Type 1+2 in housing with terminals	1	160.000	<b>5088 69 2</b>

/pc.

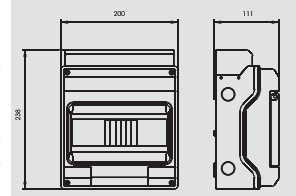

## Photovoltaic housing with connection terminals, type 2, 1000 V DC

Type	U max DC V	Version	Pack. pcs	Weight kg/100 pcs.	Item No.
<b>VG-C DCPH-MS1000</b>	1000	Type 2 in housing with terminals	1	154.000	<b>5088 69 1</b>

/pc.

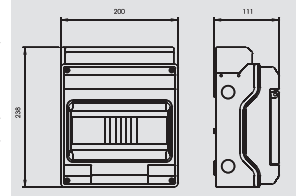

## Photovoltaic housing with connection terminals, type 2, 1000 V DC

Type	U max DC V	Version	Pack. pcs	Weight kg/100 pcs.	Item No.
<b>VG-C DCPH1000-4K</b>	1000	Type 2 in housing with V-Tec insertion	1	162.000	<b>5088 65 0</b>

/pc.

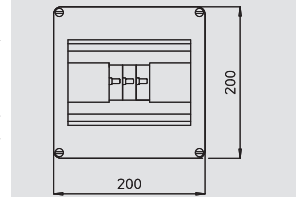

VG-BC DCPH-MS600

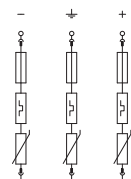

VG-BC DCPH-MS900

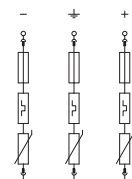

VG-C DCPH-MS1000

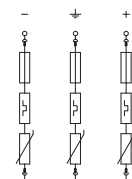

VG-C DCPH1000-4K

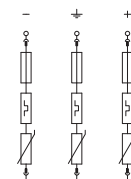

U max DC	U <sub>c</sub> DC V	600	900	1000	1000
SPD to EN 61643-11		Type 1+2	Type 1+2	Type 2	Type 2
Lightning protection Zone LPZ		0→2	0→2	1→2	1→2
Impulse discharge current (10/350)	I <sub>imp</sub> kA	12,5	7	20	20
Nominal discharge current (8/20)	I <sub>n</sub> kA	30	30	40	40
Maximum discharge current	I <sub>max</sub> kA	50	50	40	40
Voltage protection level	U <sub>p</sub> max kV	< 2,6	< 3,0	< 4,0	< 4,0
Response time	t <sub>A</sub> ns	< 25	< 25	< 25	< 25
Connection cross-section, rigid	mm <sup>2</sup>	0,5 - 6	0,5 - 6	0,5 - 6	0,5 - 6
Connection cross-section, flexible	mm <sup>2</sup>	0,5 - 6	0,5 - 6	0,5 - 6	0,5 - 6
Temperature range	θ °C	-40 - +80	-40 - +80	-40 - +80	-40 - +80
Degree of protection of enclosure		IP 65	IP 65	IP 65	IP 65
<b>Item No.</b>		<b>5088 69 3</b>	<b>5088 69 2</b>	<b>5088 69 1</b>	<b>5088 65 0</b>



# Photovoltaic system solution with connection terminals with IR

System solution for photovoltaic systems with connection terminals and remote signalling



- Error-resistant Y circuit for use according to VDE 0100-712 (IEC 60364-7-712)
- Low DC protection level: < 3.0 kV (Voc max = 900 V DC with V25-B+C/0-450PV)
- Low DC protection level: < 2.6 kV (Voc max = 600 V DC with V50-B+C/0-300PV)
- 5 parallel connection terminals up to 6 mm<sup>2</sup> for each polarity (+ and -)
- Pre-mounted in IP65 housing

Note: 5 PV strings can be switched in parallel on the terminals. The technical data (string voltage, etc.) and the conditions of the converter (number of MPP trackers) must be taken into account.

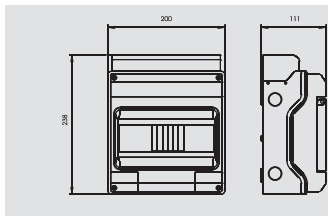

## Photovoltaic housing 600 V DC with connection terminals with IR

Type	U max DC V	Version	Pack. pcs	Weight kg/100 pcs.	Item No.
<b>VG-BC DC-MSFS600</b>	600	Type 1+2 in housing with terminals	1	167.000	<b>5088 69 5</b>

/pc.

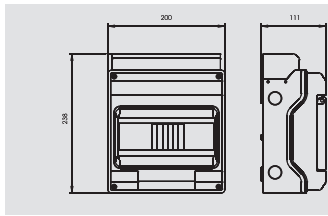

## Photovoltaic housing 900 V DC with connection terminals with IR

Type	U max DC V	Version	Pack. pcs	Weight kg/100 pcs.	Item No.
<b>VG-BC DC-MSFS900</b>	900	Type 1+2 in housing with terminals	1	168.000	<b>5088 69 6</b>

/pc.



VG-BC DC-MSFS600

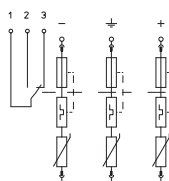

VG-BC DC-MSFS900

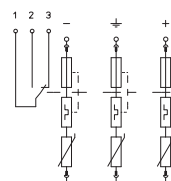

U max DC	U <sub>c</sub> DC V	600	900
SPD to EN 61643-11		Type 1+2	Type 1+2
Lightning protection Zone LPZ		0→2	0→2
Impulse discharge current (10/350)	I <sub>imp</sub> kA	12,5	7
Nominal discharge current (8/20)	I <sub>n</sub> kA	30	30
Maximum discharge current	I <sub>max</sub> kA	50	60
Voltage protection level	U <sub>p</sub> max kV	< 2,6	< 3,0
Response time	t <sub>A</sub> ns	< 25	< 25
Connection cross-section, rigid	mm <sup>2</sup>	0,5 - 6	0,5 - 6
Connection cross-section, flexible	mm <sup>2</sup>	0,5 - 6	0,5 - 6
Temperature range	θ °C	-40 - +80	-40 - +80
Degree of protection of enclosure		IP 65	IP 65
<b>Item No.</b>		<b>5088 69 5</b>	<b>5088 69 6</b>



# Photovoltaic system solution with connection terminals and V-Tec entry



- System solution for photovoltaic systems with connection terminals and entry
- Error-resistant Y circuit for use according to VDE 0100-712 (IEC 60364-7-712)
  - Low DC protection level: < 4.0 kV (Voc max = 1,000 V DC with V20-C/0-500PV)
  - 5 parallel connection terminals up to 6 mm<sup>2</sup> for each polarity (+ and -)
  - 8 V-Tec entries per side, pre-mounted in IP65 housing
  - Arrestor, connectable with thermodynamic cut-off unit and visual function display
  - Encapsulated, non-extinguishing zinc oxide varistor arrestor for use in distributor housings

Note: 5 PV strings can be switched in parallel on the terminals. The technical data (string voltage, etc.) and the conditions of the inverter (number of MPP trackers) must be taken into account.



## Photovoltaic housing with V-Tec entry

Type	U <sub>max</sub> DC V	Version	Pack. pcs	Weight kg/100 pcs.	Item No.
<b>VG-C DC-PH1000-4</b>	1000	Type 2 in housing with V-Tec insertion	1	145.000	<b>5088 70 3</b>

/pc.

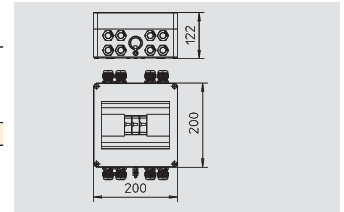

Surge protection, photovoltaics

VG-C DC-PH1000-4

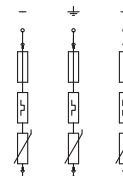

U <sub>max</sub> DC	U <sub>c</sub> DC	V	1000
SPD to EN 61643-11			Type 2
Lightning protection Zone LPZ			1→2
Nominal discharge current (8/20)	I <sub>n</sub>	kA	20
Maximum discharge current	I <sub>max</sub>	kA	40
Voltage protection level	U <sub>p</sub>	kV	< 4,0
Response time	t <sub>A</sub>	ns	< 25
Connection cross-section, rigid		mm <sup>2</sup>	0,5 - 6
Connection cross-section, flexible		mm <sup>2</sup>	0,5 - 6
Temperature range	θ	°C	-40 - +80
Degree of protection of enclosure			IP 65
<b>Item No.</b>			<b>5088 70 3</b>

# Photovoltaic system solution with MC4 connector

System solution for photovoltaic systems with MC4 connector

Type 2	LPZ 1→2	Type 1+2	LPZ 0→2
--------	---------	----------	---------



- Error-resistant Y circuit for use according to VDE 0100-712 (IEC 60364-7-712)
- Low DC protection level: < 4.0 kV (Voc max = 1,000 V DC with V20-C/0-500PV)
- Low DC protection level: < 3.0 kV (Voc max = 900 V DC with V25-B+C/0-450PV)
- Low DC protection level: < 2.6 kV (Voc max = 600 V DC with V50-B+C/0-300PV)
- DC connection with MC4 plug connector (Series: PV-AD...P 4/6), pre-mounted in IP65 housing

Application: PV systems to protect the inverter

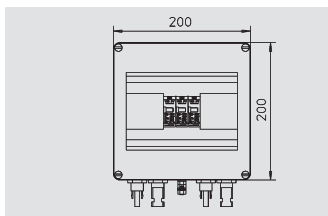

## Photovoltaic system solution, type 1+2, with MC connector, 600 V DC

Type	U max DC V	Version	Pack. pcs	Weight kg/100 pcs.	Item No.
<b>VG-BC DCPH-Y600</b>	600	Equipped in housing with MC4 connector	1	174.600	<b>5088 67 6</b>

/pc.

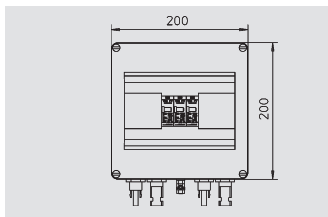

## Photovoltaic system solution, type 1+2, with MC connector, 900 V DC

Type	U max DC V	Version	Pack. pcs	Weight kg/100 pcs.	Item No.
<b>VG-BC DCPH-Y900</b>	900	Equipped in housing with MC4 connector	1	178.500	<b>5088 67 8</b>

/pc.

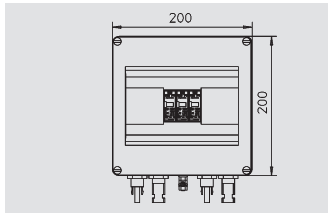

## Photovoltaic system solution, type 2, with MC connector, 600 V DC

Type	U max DC V	Version	Pack. pcs	Weight kg/100 pcs.	Item No.
<b>VG-C DCPH-Y600</b>	600	Equipped in housing with MC4 connector	1	166.500	<b>5088 67 0</b>

/pc.

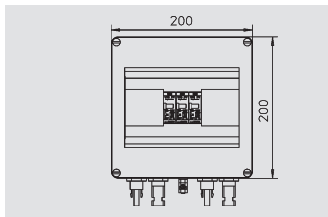

## Photovoltaic system solution, type 2, with MC connector, 1000 V DC

Type	U max DC V	Version	Pack. pcs	Weight kg/100 pcs.	Item No.
<b>VG-C DCPH-Y1000</b>	1000	Equipped in housing with MC4 connector	1	169.500	<b>5088 67 2</b>

/pc.



VG-BC DCPH-Y600

VG-BC DCPH-Y900

VG-C DCPH-Y600

VG-C DCPH-Y1000

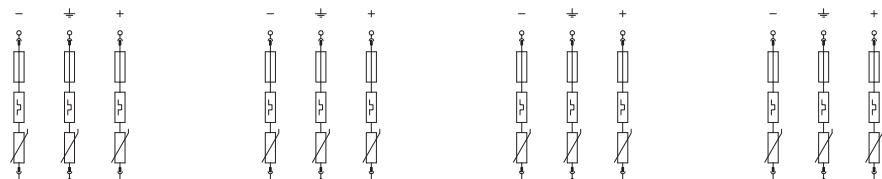

U max DC SPD to EN 61643-11 Lightning protection Zone LPZ Impulse discharge current (10/350) Nominal discharge current (8/20) Maximum discharge current Voltage protection level Response time Temperature range Degree of protection of enclosure	U <sub>c</sub> DC V									
	600	Type 1+2	0→2	12,5	30	50	< 2,6	< 25	-40 - +80	IP65
	900	Type 1+2	0→2	7	30	50	< 3,0	< 25	-40 - +80	IP65
	600	Type 2	1→2		20	40	< 2,6	< 25	-40 - +80	IP65
	1000	Type 2	1→2		20	40	< 4,0	< 25	-40 - +80	IP65
<b>Item No.</b>		<b>5088 67 6</b>								
		<b>5088 67 8</b>								
		<b>5088 67 0</b>								
		<b>5088 67 2</b>								



# Photovoltaic system solution, unequipped

Type	LPZ	Type	LPZ
2	1→2	1+2	0→1



The V 20-C/U-PH is the basic module for overvoltage protection of photovoltaic systems. The simple connection of plus, minus and earth lines enables optimum protection in the branch distributor directly behind the photovoltaic modules and before the converter. The basic module is connected between solar module and converter.

Note: the required top parts are subject to separate order. When connecting the outer lightning protection system to the solar module, the top part of the V25-B+C must be used. The protection modules are to be selected in accordance with the open-circuit voltage of the solar module.



## Photovoltaic housing for inverter with 2 MPP trackers, unequipped

Type	U max DC	Version	Pack.	Weight	Item No.
	V		pcs	kg/100 pcs.	
<b>VG-C DC-PH-21</b>	1000	in housing with MC4 connector.	1	380.000	<b>5088 60 5</b>

/pc.

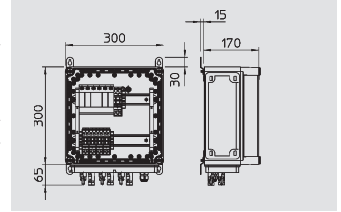

## Photovoltaic housing for inverter with 3 MPP trackers, unequipped

Type	U max DC	Version	Pack.	Weight	Item No.
	V		pcs	kg/100 pcs.	
<b>VG-C DC-PH-31</b>	1000	in housing with MC4 connector.	1	466.000	<b>5088 60 9</b>

/pc.

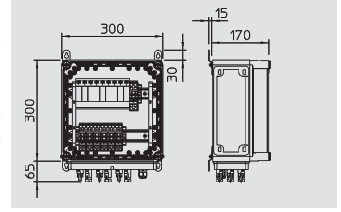

## Photovoltaic housing with connection terminals, unequipped

Type	U max DC	Version	Pack.	Weight	Item No.
	V		pcs	kg/100 pcs.	
<b>VG-C DC-PH-MS</b>	1000	in housing with terminals	1	135.000	<b>5088 69 4</b>

/pc.

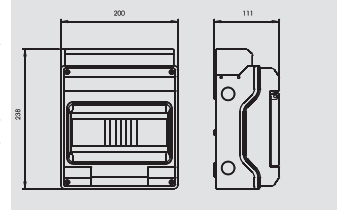

## Photovoltaic housing with MC 4 connector, unequipped

Type	U max DC	Version	Pack.	Weight	Item No.
	V		pcs	kg/100 pcs.	
<b>VG-C DC-PH-Y</b>	1000	in housing with MC4 connector	1	150.000	<b>5088 69 9</b>

/pc.

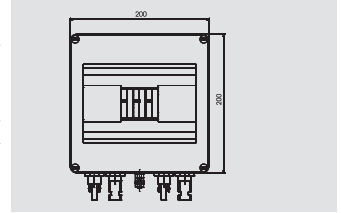

VG-C DC-PH-21

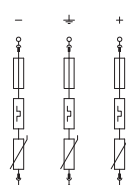

VG-C DC-PH-31

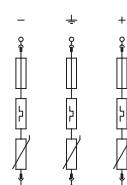

VG-C DC-PH-MS

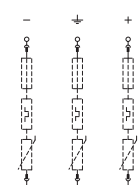

VG-C DC-PH-Y

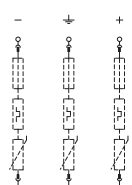

U max DC	U <sub>c</sub> DC	V	1000	1000	1000	1000
Connection cross-section, rigid		mm <sup>2</sup>			0,5 - 6	
Connection cross-section, flexible		mm <sup>2</sup>			0,5 - 6	
Temperature range	θ	°C	-40 - +80	-40 - +80	-40 - +80	-40 - +80
Degree of protection of enclosure			IP65	IP65	IP 65	IP 65
<b>Item No.</b>			<b>5088 60 5</b>	<b>5088 60 9</b>	<b>5088 69 4</b>	<b>5088 69 9</b>



- Upper part, combination and surge controller, type 1+2 and 2 arrestors for photovoltaic systems
- Lightning and surge voltage protection equipotential bonding to VDE 0100-443 (IEC 60364-4-44)
  - Arresting capacity to 12.5 kA (10/350) and 50 kA (8/20) per pin
  - DC protection level: < 2.0 kV per pole (for Y circuit: 40 kV and Voc to 1000 V DC)
  - Arrestor, connectable with thermodynamic cut-off unit and function display
  - Encapsulated, non-blow out zinc oxide varistor arrestor for use in distributor housings
  - High current carrying capacity with long lifespan

Type 1+2	Type 2	LPZ 0→1	LPZ 1→2
----------	--------	---------	---------



Application: Surge and lightning protection for PV systems

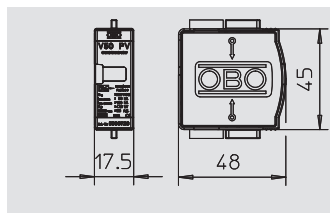

### Photovoltaic upper part- lightning and surge arrestors

Type	U max DC V	Version	Pack. pcs	Weight kg/100 pcs.	Item No.
V50-B+C 0-300PV	300	1-pole, PV upper part, Type 1+2	1	8.200	5093 72 6

/pc.

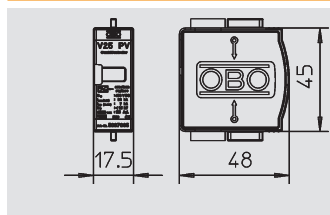

### Photovoltaic upper part – lightning and surge arrestors

Type	U max DC V	Version	Pack. pcs	Weight kg/100 pcs.	Item No.
V25-B+C 0-450PV	450	1-pole, PV upper part, Type 1+2	1	9.500	5097 06 5

/pc.

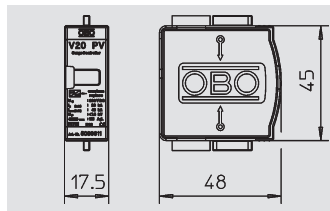

### Photovoltaic upper part- surge arrestors

Type	U max DC V	Version	Pack. pcs	Weight kg/100 pcs.	Item No.
V20-C 0-300PV	300	1-pole, PV upper part, type 2	1	5.500	5099 61 1

/pc.

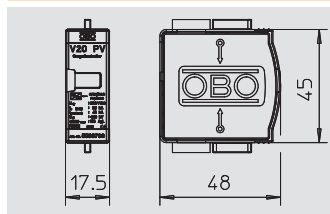

### Photovoltaic upper part – surge arrestors

Type	U max DC V	Version	Pack. pcs	Weight kg/100 pcs.	Item No.
V20-C 0-500PV	500	1-pole, PV upper part, type 2	1	6.500	5099 70 8

/pc.



Surge protection, photovoltaics



02\_TBS\_Masterkatalog\_Länder\_2012 / en / 29/05/2012 (LLEExport\_014333) / 29/05/2012

V50-B+C 0-300PV



V25-B+C 0-450PV



V20-C 0-300PV



V20-C 0-500PV



U max DC	U <sub>c</sub> DC V		300	450	300	500
SPD to EN 61643-11			Type 1+2	Type 1+2	Type 2	Type 2
SPD to IEC 61643-11			class I+II	class I+II	class II	class II
Lightning protection Zone LPZ			0→2	0→2	1→2	1→2
Nominal discharge current (8/20)	I <sub>n</sub> kA		30	30	20	20
Impulse discharge current (10/350)	I <sub>imp</sub> kA		12,5	7		
Maximum discharge current	I <sub>max</sub> kA		50	50	40	40
Voltage protection level	U <sub>p</sub> max kV		< 1,3	< 1,5	< 1,3	< 2,0
Response time	t <sub>A</sub> ns		<25	< 25	< 25	< 25
Maximum back-up fuse	A		125	160	125	125
Temperature range	θ °C		-40 - +80	-40 - +80	-40 - +80	-40 - +80
Degree of protection of enclosure			IP 20	IP 20	IP 20	IP 20
Division unit TE (17.5 mm)			1	1	1	1
<b>Item No.</b>			<b>5093 72 6</b>	<b>5097 06 5</b>	<b>5099 61 1</b>	<b>5099 70 8</b>

# Photovoltaic bases

Type 1+2	Type 2	LPZ 0→1	LPZ 1→2
FS	5		

Base for combination and surge controller, type 1+2 and 2 for photovoltaic systems

- Error resistant Y circuit with 3 varistors (2 for earthed systems)
- Lightning and surge voltage protection equipotential bonding to VDE 0100-443 (IEC 60364-4-44)
- Arresting capacity to 12.5 kA (10/350) and 50 kA (8/20) per pin
- DC protection level: < 2.0 kV per pole (Y circuit: 4.0 kV and max. Voc to 1,000 V DC)
- Encapsulated, non-extinguishing zinc oxide varistor arrester for use in distributor housings
- High current carrying capacity with long lifespan
- Bases unequipped

Application: Surge and lightning protection for PV systems



## PV base, 3-pole in Y circuit

Type	Version	Pack.	Weight	Item No.
		pcs	kg/100 pcs.	
<b>V20-C U-3PH-Y</b>	3-pole Y circuit for PV	1	17.000	<b>5096 64 7</b>

/pc.

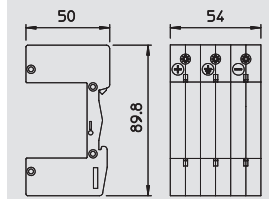

## PV base, 3-pole in Y circuit with remote signalling

Type	Version	Pack.	Weight	Item No.
		pcs	kg/100 pcs.	
<b>V20-C U-3PH-Y-FS</b>	3-pole Y circuit for photovoltaic systems with FS	1	25.000	<b>5096 64 6</b>

/pc.

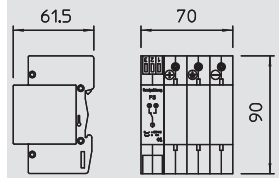

## PV base, 2-pole in Y circuit

Type	Version	Pack.	Weight	Item No.
		pcs	kg/100 pcs.	
<b>V20-C U-2 PH</b>	2-pole for earthed PV systems	1	14.000	<b>5096 63 7</b>

/pc.

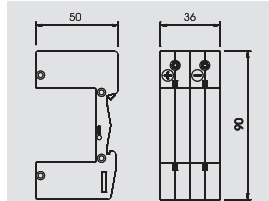

## PV base, 2-pole in Y circuit with remote signalling

Type	Version	Pack.	Weight	Item No.
		pcs	kg/100 pcs.	
<b>V20-C U-2 PH+FS</b>	2-pole for earthed PV systems with FS	1	18.000	<b>5096 63 9</b>

/pc.

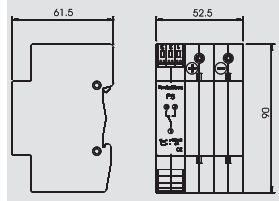

V20-C U-3PH-Y

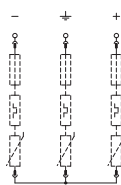

V20-C U-3PH-Y-FS

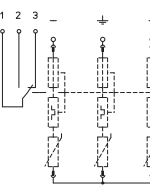

V20-C U-2 PH

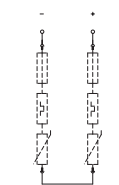

V20-C U-2 PH+FS

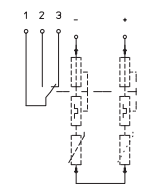

Temperature range	θ	°C	-40 - +80	-40 - +80	-40 - +80	-40 - +80
Degree of protection of enclosure			IP 20	IP 20	IP 20	IP 20
Division unit TE (17.5 mm)			3	4	2	3
Connection cross-section, rigid	mm <sup>2</sup>		2,5 - 35	2,5 - 35	2,5 - 35	2,5 - 35
Connection cross-section, multi-wire	mm <sup>2</sup>		2,5 - 35	2,5 - 35	2,5 - 35	2,5 - 35
Connection cross-section, flexible	mm <sup>2</sup>		2,5 - 25	2,5 - 25	2,5 - 25	2,5 - 25
<b>Item No.</b>			<b>5096 64 7</b>	<b>5096 64 6</b>	<b>5096 63 7</b>	<b>5096 63 9</b>



















## Surge protection of data and information technology

	Surge protection	For telecommunication	236
		LSA-Plus systems	241
	Coaxial protection devices	Send-and-receive technology	245
	Surge protection	Network technology	250
		Data technology	252
		Serial interfaces	255
	MCR protection	2-pole power supply	259
		Two-core systems	265
		Multi-wire system (testable)	274
	MCR protection	Explosive areas	282



## Surge protection devices for telecommunications applications

- +Simple installation
- +Low protection level
- +High arresting capacity
- +High bandwidth
- +Wide range of uses



The data cable protection devices for telecommunications applications are available as combination protection and fine protection.

Depending on the application, from DSL through to analogue communication, the devices are used for direct intermediate switching into the data cable, meaning that they can easily be retrofitted in existing installations.

The devices differ in their connec-

tion technology and transmission cable and are thus optimised for their appropriate applications, in order to cause the lowest attenuation level possible.



# Surge protection for telecommunication systems

## Combination protection device for ISDN and DSL systems

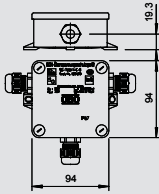

Type	Version	Connection system	Pack.	Weight	Item No.
			pcs	kg/100 pcs.	
<b>SC-TELE 4-C-G</b>	Combi protection	Terminal	1	30.000	<b>5081 68 8</b>



- Suitable for any analogue, ISDN or DSL systems
- Insulating housing to IP 54
- With screwless terminals for quick mounting
- For 2 DA systems (4 protected cores)

/pc.



## Combination protection device for ISDN

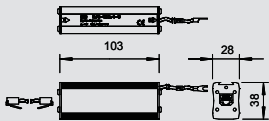

Type	Version	Connection system	Pack.	Weight	Item No.
			pcs	kg/100 pcs.	
<b>RJ11-TELE 4-C</b>	Combi protection, 4 wires	—	1	14.000	<b>5081 92 0</b>



- In aluminium housing
- Simple mounting on hat rail or on terminal
- Incl. 150 mm connection cable with RJ411 connectors
- Optimised bandwidth for telecommunications systems

/pc.

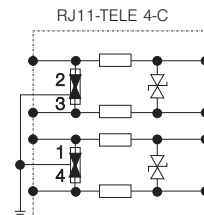
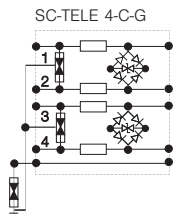

U max AC	U <sub>c</sub> AC	V	122	122
U max DC	U <sub>c</sub> DC	V	170	170
Lightning protection Zone LPZ			0-3	0-3
Impulse discharge current (10/350)	I <sub>imp</sub>	kA	5	1,5
Nominal discharge current (8/20)	I <sub>n</sub>	kA	15	7,5
Transmission frequency	f		100 MHz	12 MHz
Insertion loss	a/dB	dB	0,1 @ 144 kHz	3dB @ 12 MHz
Series resistance	R	ohm	3,3	8,2
Protection level (sym.) with In C2			≤300 V	≤300 V
Protection level (asym.) with In C2			≤500 V	≤500 V
Protection level (asym.) with 1 kV/μs C3			≤245 V	≤245 V
Degree of protection of enclosure			IP 54	IP40
Connection system			Terminal	
<b>Item No.</b>			<b>5081 68 8</b>	<b>5081 92 0</b>



# Surge protection for telecommunication systems

Surge protection device for data and information technology

LPZ 0→3 Analog TK ISDN 5

## Combination protection device for ISDN RJ11

Type	Version	Connection system	Pack.	Weight	Item No.
			pcs	kg/100 pcs.	
<b>RJ11-TELE 4-C</b>	Combi protection, 4 wires	—	1	14.000	<b>5081 92 0</b>



- In aluminium housing
- Simple mounting on hat rail or on terminal
- Incl. 150 mm connection cable with RJ411 connectors
- Optimised bandwidth for telecommunications systems

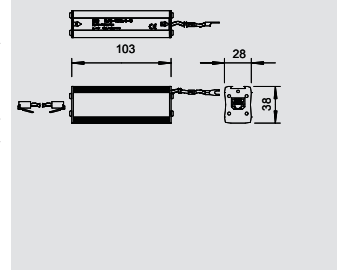

/pc.

Analog TK LPZ 1→3 ISDN 5

## Fine protection device for ISDN RJ11

Type	Version	Connection system	Pack.	Weight	Item No.
			pcs	kg/100 pcs.	
<b>RJ11-TELE 4-F</b>	Fine protection, 4 wires	—	1	14.000	<b>5081 93 9</b>



- In aluminium housing
- Simple mounting on hat rail or on terminal
- Incl. 150 mm connection cable with RJ11 connectors
- Optimised bandwidth for telecommunications systems

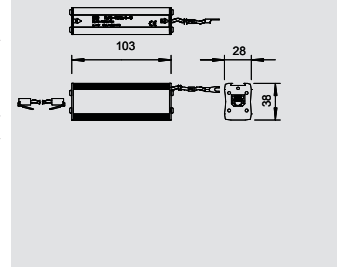

/pc.

LPZ 0→3 Analog TK ISDN 5

## Combination protection device for ISDN RJ45

Type	Version	Connection system	Pack.	Weight	Item No.
			pcs	kg/100 pcs.	
<b>RJ45-TELE 4-C</b>	Combi protection, 4 wires	RJ45	1	14.000	<b>5081 96 3</b>



- In aluminium housing
- Simple mounting on hat rail or on terminal
- Incl. 150 mm connection cable with RJ45 connectors
- Optimised bandwidth for telecommunications systems

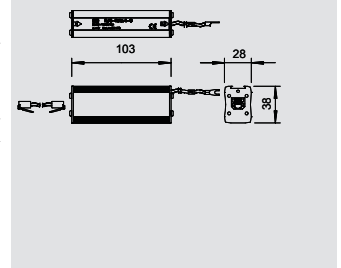

/pc.

Analog TK LPZ 1→3 ISDN 5

## Fine protection device for ISDN RJ45

Type	Version	Connection system	Pack.	Weight	Item No.
			pcs	kg/100 pcs.	
<b>RJ45-TELE 4-F</b>	Fine protection, 4 wires	RJ45	1	14.000	<b>5081 97 1</b>



- In aluminium housing
- Simple mounting on hat rail or on terminal
- Incl. 150 mm connection cable with RJ45 connectors
- Optimised bandwidth for telecommunications systems

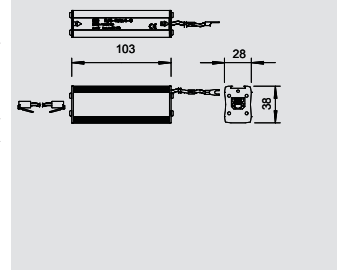

/pc.

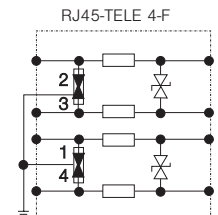
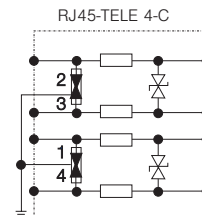
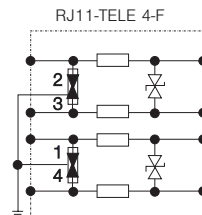
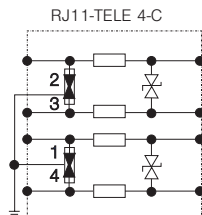

U max AC	U <sub>c</sub> AC	V	122	122	122	122
U max DC	U <sub>c</sub> DC	V	170	170	170	170
Lightning protection Zone LPZ			0→3	1→3	0→3	1→3
Impulse discharge current (10/350)	I <sub>imp</sub>	kA	1,5	-	1,5	-
Nominal discharge current (8/20)	I <sub>n</sub>	kA	7,5	7,5 / 0,5	7,5	7,5 / 0,5
Transmission frequency	f	Hz	12 MHz	18 MHz	12 MHz	18 MHz
Insertion loss	a/dB	dB	3dB @ 12 MHz	3dB @ 18 MHz	3dB @ 12 MHz	3dB @ 18 MHz
Series resistance	R	ohm	8,2	2,2	8,2	2,2
Protection level (sym.) with In C2		V	≤300 V	≤300 V	≤300 V	≤300 V
Protection level (asym.) with In C2		V	≤500 V	≤500 V	≤500 V	≤500 V
Protection level (asym.) with 1 kV/μs C3		V	≤245 V	≤245 V	≤245 V	≤245 V
Degree of protection of enclosure			IP40	IP40	IP40	IP40
Connection system					RJ45	RJ45
<b>Item No.</b>			<b>5081 92 0</b>	<b>5081 93 9</b>	<b>5081 96 3</b>	<b>5081 97 1</b>

# Surge protection for telecommunication systems

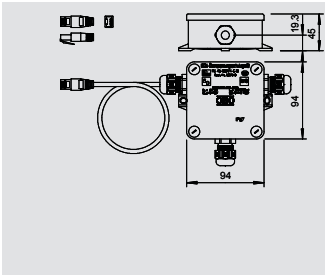

## Combination protection device for ISDN bus side



Type	Version	Connection system	Pack.	Weight	Item No.
			pcs	kg/100 pcs.	
<b>RJ45-ISDN 4-C-G</b>	Combi protection, 4 wires	RJ45	1	30.000	<b>5081 54 8</b>

/pc.

- For bus-side use on ISDN
- Insulating housing to IP 54
- With screwless terminals for quick mounting
- For 2 DA systems (4 protected cores)



Surge protection device for data and information technology

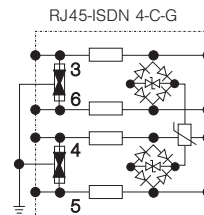

U max AC	U <sub>c</sub> AC	V	4.2
U max DC	U <sub>c</sub> DC	V	6.2
Lightning protection Zone LPZ			0-3
Impulse discharge current (10/350)	I <sub>imp</sub>	kA	2
Nominal discharge current (8/20)	I <sub>n</sub>	kA	10
Transmission frequency	f		< 6 MHz
Insertion loss	a/dB	dB	0,1 @ 144 kHz
Series resistance	R	ohm	4.7
Protection level (sym.) with In C2			≤500 V
Protection level (asym.) with In C2			≤12 V
Protection level (asym.) with 1 kV/μs C3			≤8 V
Degree of protection of enclosure			IP 54
Connection system			RJ45
<b>Item No.</b>			<b>5081 54 8</b>

## Surge protection devices for industrial telecommunications applications

- +Simple installation
- +Protection up to 10 two-core wires
- +Low protection level
- +High arresting capacity
- +High broadband in basic protection
- +Wide range of uses

Surge protection device for data and information technology

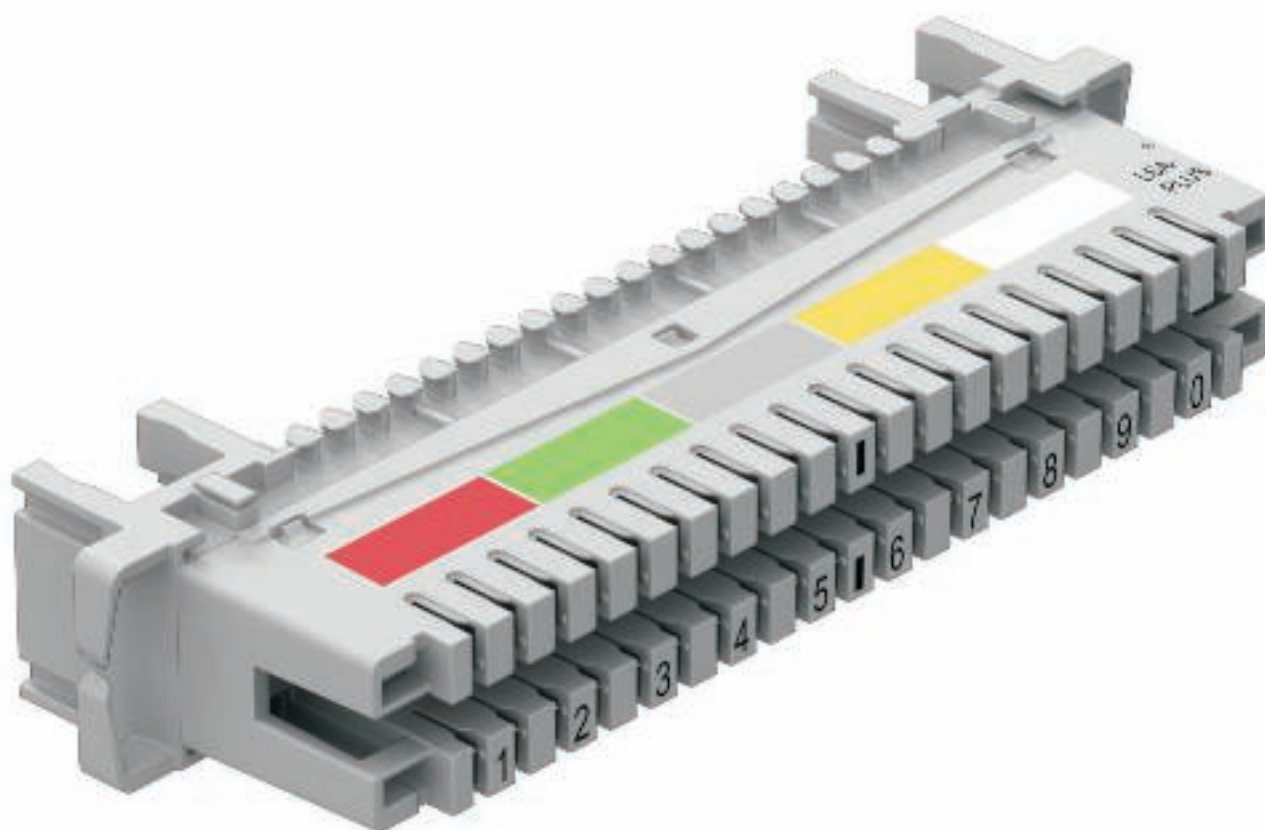

In particular with multi-wire cable systems, such as telecommunications distribution systems, the LSA surge voltage components offer rapid, adequate protection. The LSA system offers both basic protection modules and fine protection modules to protect up to ten two-core wires per connection strip. These are split up into separating and connection strips and

must be selected according to the application.



# Surge protection for LSA-Plus systems

Data cable protection for multi-wire systems (LSA-Plus)

- Available as basic and combination protection
- Protects up to 10 two-cores
- Low protection level
- Bandwidth-optimised for secure transmission
- Quick mounting on hat rail or wall mounting



Application: Telecommunications switchboards, TC extensions

LSA-Plus technology / LSA connection strip		Pack.	Weight	Item No.
Type	Colour	pcs	kg/100 pcs.	
LSA-A-LEI	Grey	1	5.100	5084 00 8

LSA-Plus technology / LSA separating strip		Pack.	Weight	Item No.
Type	Colour	pcs	kg/100 pcs.	
LSA-T-LEI	White	1	5.400	5084 01 2

LSA-Plus technology / LSA earthing strip		Pack.	Weight	Item No.
Type	Colour	pcs	kg/100 pcs.	
LSA-E-LEI	Red	1	6.500	5084 01 6

LSA-Plus technology / LSA basic protection		Pack.	Weight	Item No.
Type	Max. continuous operating voltage V	pcs	kg/100 pcs.	
LSA-B-MAG	180	1	8.600	5084 02 0

Surge protection device for data and information technology

02\_TBS\_Masterkatalog\_Länder\_2012 / en / 29/05/2012 (LLEExport\_014333) / 29/05/2012

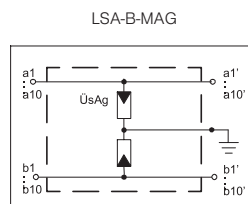

Max. continuous operating voltage	$U_c$	V	180
Lightning protection Zone LPZ			0-2
Impulse discharge current (10/350)	$I_{imp}$	kA	1
Nominal discharge current (8/20)	$I_n$	kA	5
Maximum discharge current	$I_{max}$	kA	10
Voltage protection level	$U_p$	kV	<0,700
Temperature range	$\vartheta$	°C	-40 - +80
<b>Item No.</b>			<b>5084 02 0</b>

# Surge protection for LSA-Plus systems



Data cable protection for multi-wire systems (LSA-Plus)

- Available as basic and combination protection
- Protects up to 10 two-cores
- Low protection level
- Bandwidth-optimised for secure transmission
- Quick mounting on hat rail or wall mounting

Application: Telecommunications switchboards, TC extensions

## LSA-Plus technology/LSA basic and fine protection



Type	Max. continuous operating voltage V	Pack. pcs	Weight kg/100 pcs.	Item No.
<b>LSA-BF-180</b>	180	1	0.500	<b>5084 02 4</b>

/pc.

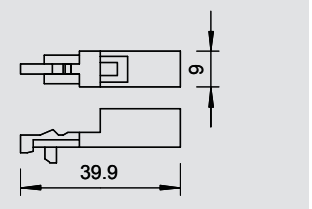

## LSA-Plus technology/LSA basic and fine protection



Type	Max. continuous operating voltage V	Pack. pcs	Weight kg/100 pcs.	Item No.
<b>LSA-BF-24</b>	24	1	0.500	<b>5084 02 8</b>

/pc.

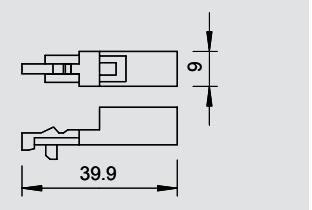

## LSA-Plus technology / LSA earthing rail for LSA-BF



Type	Pack. pcs	Weight kg/100 pcs.	Item No.
<b>LSA-E</b>	1	1.000	<b>5084 03 2</b>

/pc.

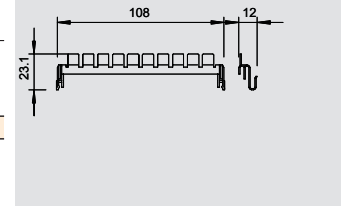

## LSA-Plus technology / LSA installation trough



Type	Pack. pcs	Weight kg/100 pcs.	Item No.
<b>LSA-M</b>	1	7.800	<b>5084 03 6</b>

/pc.

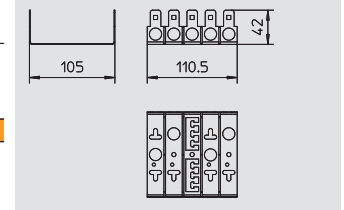

St Steel

LSA-BF-180

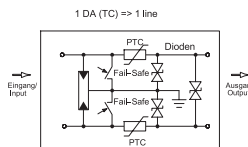

LSA-BF-24

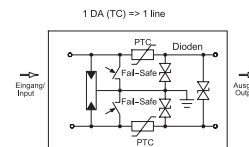

Max. continuous operating voltage	$U_c$	V	180	24
Lightning protection Zone LPZ			0-3	0-3
Impulse discharge current (10/350)	$I_{imp}$	kA	0,5	0,5
Nominal discharge current (8/20)	$I_n$	kA	2.5	2.5
Maximum discharge current	$I_{max}$	kA	5	5
Rated current	$I_L$	A	0.12	0.09
Voltage protection level	$U_p$	kV	< 300	< 0,05
Temperature range	$\vartheta$	°C	-40 - +80	-40 - +80
<b>Item No.</b>			<b>5084 02 4</b>	<b>5084 02 8</b>



# Surge protection for LSA-Plus systems

## Data cable protection for multi-wire systems (LSA-Plus)

- Available as basic and combination protection
- Protects up to 10 two-cores
- Low protection level
- Bandwidth-optimised for secure transmission
- Quick mounting on hat rail or wall mounting



Application: Telecommunications switchboards, TC extensions

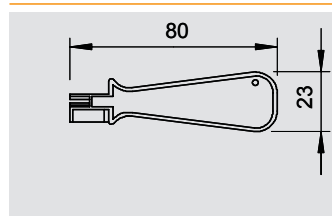

### LSA-Plus technology / LSA simple tool

Type	Pack.	Weight	Item No.
	pcs	kg/100 pcs.	
<b>LSA-TOOL</b>	1	0.600	<b>5084 04 0</b>

/pc.

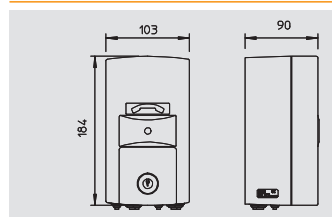

### LSA-Plus technology / protective housing

Type	Colour	Pack.	Weight	Item No.
		pcs	kg/100 pcs.	
<b>LSA-G</b>	Light grey	1	57.500	<b>5084 04 8</b>

**PA** Polyamide /pc.



Surge protection device for data and information technology





## Surge protection for high frequency applications: the plus of the DS family

- +Coaxial protection devices
- +Optimum protection for sensitive systems
- +Low insertion attenuation and low return attenuation at different wave resistances
- +High bandwidth



The coaxial protection devices of type DS offer optimum protection of sensitive systems, based on coaxial plug connections. The low insertion attenuation and low return attenuation at different wave resistances offer ideal protection for any application. In accordance with their structure, the protection devices are switched into the application in series, and are connected to the local equipotential bonding. The direct shield earthing

avoids reducing of the shield performance.

# Coaxial protection devices for transmission and reception technology

Data cable protection devices for transmission and reception technology

- Different connection systems available
- Low protection level at high current load
- Low reflection behaviour
- Bandwidth-optimised for secure transmission
- Available in 50 Ω and 75 Ω technology

Application: BOS radio, SAT and TV systems, mobile radio

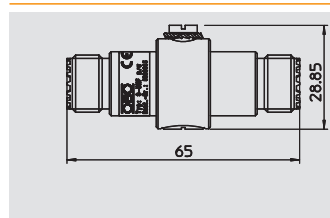

## Coaxial protection devices for S-UHF connection: male/female

Type	Connection system	Bandwidth	Pack. pcs	Weight kg/100 pcs.	Item No.
S-UHF M/W	UHF connector	0 - 1,3 GHz	1	7.000	5093 02 3

/pc.

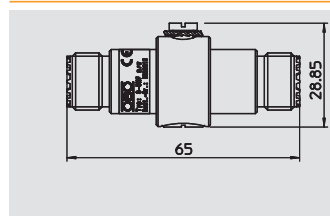

## Coaxial protection devices for S-UHF connection: female/female

Type	Connection system	Bandwidth	Pack. pcs	Weight kg/100 pcs.	Item No.
S-UHF W/W	UHF connector	0 - 1,3 GHz	1	6.500	5093 01 5

/pc.

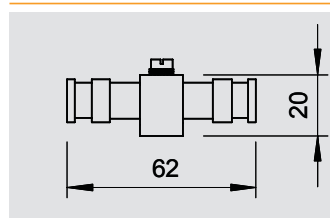

## Coaxial protection device for BNC connection: male/female

Type	Connection system	Bandwidth	Pack. pcs	Weight kg/100 pcs.	Item No.
DS-BNC M/W	BNC, 50 Ohm	0 - 2,2 GHz	1	6.500	5093 25 2

/pc.

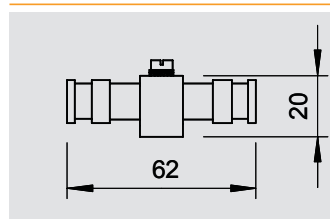

## Coaxial protection device for BNC connection: female/female

Type	Connection system	Bandwidth	Pack. pcs	Weight kg/100 pcs.	Item No.
DS-BNC W/W	BNC, 50 Ohm	0 - 2,2 GHz	1	6.000	5093 23 6

/pc.

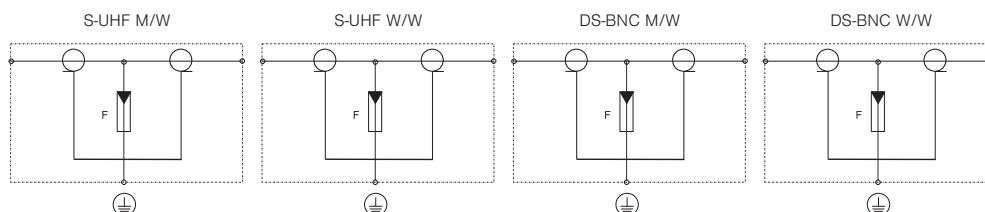

Maximum continuous operating voltage Vc/AC	V	130	130	130	130
Maximum continuous operating voltage Vc/DC	V	185	185	185	185
Degree of protection of enclosure		IP40	IP40	IP40	IP40
Lightning protection Zone LPZ		0-2	0-2	0-2	0-2
Rated current	I <sub>L</sub>	A	10	10	10
Bandwidth		0 - 1,3 GHz	0 - 1,3 GHz	0 - 2,2 GHz	0 - 2,2 GHz
Connection system		UHF connector	UHF connector	BNC, 50 Ohm	BNC, 50 Ohm
Wave resistance	Z <sub>0</sub>	Ω	50	50	50
Insertion loss	a/dB	dB	0,2 dB @ 1,3GHz	0,2 dB @ 1,3GHz	0,95 dB @ 2,2 GHz
Reflux loss		dB	14 dB @ 1,3 GHz	14 dB @ 1,3 GHz	14 dB @ 2,2 GHz
Voltage protection level line-earth	V	800	800	800	800
Total Impulse durability (10/350)	kA	D1: 5	D1: 5	D1: 5	D1: 5
Total Impulse durability (8/20)	kA	10	10	10	10
Temperature range	θ	°C	-40 - +80	-40 - +80	-40 - +80
Testing standard		IEC 61643-21	IEC 61643-21	IEC 61643-21	IEC 61643-21
<b>Item No.</b>		<b>5093 02 3</b>	<b>5093 01 5</b>	<b>5093 25 2</b>	<b>5093 23 6</b>

Surge protection device for data and information technology



02\_TBS\_Masterkatalog\_Länder\_2012 / en / 29/05/2012 (LLEExport\_01433) / 29/05/2012

# Coaxial protection devices for transmission and reception technology



Data cable protection devices for transmission and reception technology

- Different connection systems available
  - Low protection level at high current load
  - Low reflection behaviour
  - Bandwidth-optimised for secure transmission
  - Available in 50 Ω and 75 Ω technology
- Application: BOS radio, SAT and TV systems, mobile radio

## Coaxial protection device for BNC connection: male/male



Type	Connection system	Bandwidth	Pack. pcs	Weight kg/100 pcs.	Item No.
<b>DS-BNC M/M</b>	BNC, 50 Ohm	0 - 2,2 GHz	1	7.000	<b>5093 26 0</b>

/pc.

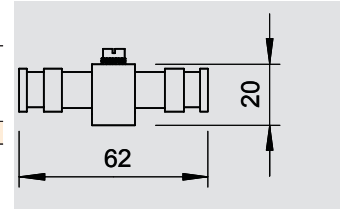

## Coaxial protection device for N connection: male/female



Type	Connection system	Bandwidth	Pack. pcs	Weight kg/100 pcs.	Item No.
<b>DS-N M/W</b>	N connector	0- 3 GHz	1	12.200	<b>5093 99 6</b>

/pc.

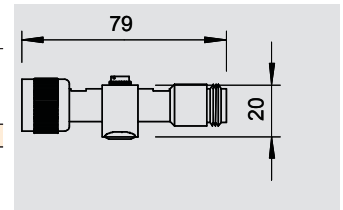

## Coaxial protection device for N connection: female/female



Type	Connection system	Bandwidth	Pack. pcs	Weight kg/100 pcs.	Item No.
<b>DS-N W/W</b>	N connector		1	12.500	<b>5093 98 8</b>

/pc.

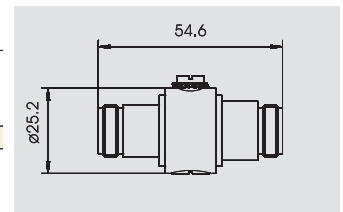

## Coaxial protection device for TNC connection: male/female



Type	Connection system	Bandwidth	Pack. pcs	Weight kg/100 pcs.	Item No.
<b>DS-TNC M/W</b>		0 - 4 GHz	1	9.000	<b>5093 27 0</b>

/pc.

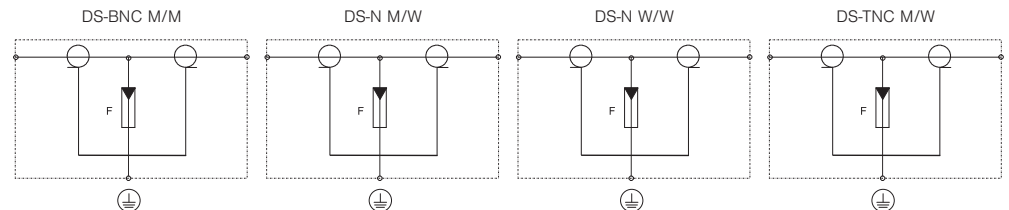
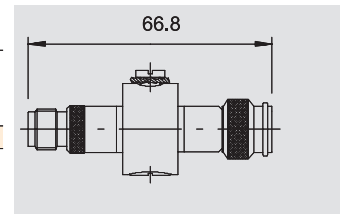

Maximum continuous operating voltage V <sub>C/AC</sub>	V	130	130	130	130
Maximum continuous operating voltage V <sub>C/DC</sub>	V	185	185	185	185
Degree of protection of enclosure		IP40	IP40	IP40	IP40
Lightning protection Zone LPZ		0-2	0-2	0-2	0-2
Rated current I <sub>L</sub>	A	10	10	10	10
Bandwidth		0 - 2,2 GHz	0- 3 GHz	0- 3 GHz	0 - 4 GHz
Connection system		BNC, 50 Ohm	N connector	N connector	
Wave resistance Z <sub>L</sub>	Ω	50	50	50	50
Insertion loss	a/dB	0,95 dB @ 2,2 GHz	0,62 dB @ 3 GHz	0,62 dB @ 3 GHz	0,5 dB @ 4 GHz
Reflux loss	dB	14 dB @ 2,2 GHz	14 dB @ 3 GHz	14 dB @ 3 GHz	14 dB @ 4 GHz
Voltage protection level line-earth	V	800	800	800	800
Total Impulse durability (10/350)	kA	D1: 5	D1: 5 kA	D1: 5 kA	D1: 5
Total Impulse durability (8/20)	kA	10	10	10	10
Temperature range	θ °C	-40 - +80	-40 - +80	-40 - +80	-40 - +80
Testing standard		IEC 61643-21	IEC 61643-21	IEC 61643-21	IEC 61643-21
<b>Item No.</b>		<b>5093 26 0</b>	<b>5093 99 6</b>	<b>5093 98 8</b>	<b>5093 27 0</b>



# Coaxial protection devices for transmission and reception technology

Data cable protection devices for transmission and reception technology

- Different connection systems available
- Low protection level at high current load
- Low reflection behaviour
- Bandwidth-optimised for secure transmission
- Available in 50 Ω and 75 Ω technology

Application: BOS radio, SAT and TV systems, mobile radio



Coaxial protection device for 7/16 connection: male/female						
Type	Connection system	Bandwidth	Pack. pcs	Weight kg/100 pcs.	Item No.	
DS-7 16 M/W	7/16 connector	0 - 3 GHz	1	35.500	5093 17 1	/pc.

Coaxial protection device for F connection: male/female						
Type	Connection system	Bandwidth	Pack. pcs	Weight kg/100 pcs.	Item No.	
DS-F M/W	SAT-F	0 - 863 MHz	1	9.000	5093 27 5	/pc.

Coaxial protection device for F connection: female/female						
Type	Connection system	Bandwidth	Pack. pcs	Weight kg/100 pcs.	Item No.	
DS-F W/W	SAT-F	0 - 863 MHz	1	9.000	5093 27 2	/pc.

Coaxial protection device for SMA connection: female/female						
Type	Connection system	Bandwidth	Pack. pcs	Weight kg/100 pcs.	Item No.	
DS-SMA W/W	—	0 - 3,7 GHz	1	7.500	5093 27 7	/pc.

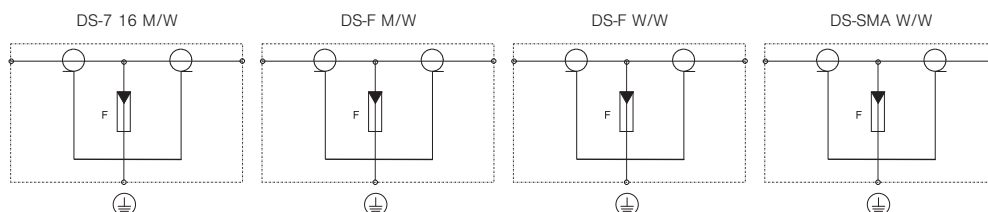

Maximum continuous operating voltage Vc/AC	V	130	130	130	130
Maximum continuous operating voltage Vc/DC	V	185	185	185	185
Degree of protection of enclosure		IP40	IP40	IP40	IP40
Lightning protection Zone LPZ		0→2	0→2	0→2	0→2
Rated current	I <sub>L</sub>	A	10	10	10
Bandwidth		0 - 3 GHz	0 - 863 MHz	0 - 863 MHz	0 - 3,7 GHz
Connection system		7/16 connector	SAT-F	SAT-F	
Wave resistance	Z <sub>w</sub>	Ω	50	75	75
Insertion loss	a/dB	dB	0,95 dB @ 3 GHz	0,18 dB @ 863 MHz	0,18 dB @ 863 MHz
Reflux loss		dB	14 dB @ 3 GHz	14 dB @ 863 MHz	14 dB @ 863 MHz
Voltage protection level line-earth	V		800	800	800
Total Impulse durability (10/350)	kA		D1: 5	D1: 5	D1: 5
Total Impulse durability (8/20)	kA		10	10	10
Temperature range	θ	°C	-40 - +80	-40 - +80	-40 - +80
Testing standard			IEC 61643-21	IEC 61643-21	IEC 61643-21
<b>Item No.</b>			<b>5093 17 1</b>	<b>5093 27 5</b>	<b>5093 27 2</b>
					<b>5093 27 7</b>

Always indicate the item number when ordering.

# Coaxial protection devices for transmission and reception technology



Data cable protection devices for transmission and reception technology

- Different connection systems available
- Low protection level at high current load
- Low reflection behaviour
- Bandwidth-optimised for secure transmission
- Available in 50 Ω and 75 Ω technology

Application: BOS radio, SAT and TV systems, mobile radio



## Coaxial protection device for SAT and cable multiswitch

Type	Connection system	transmission frequency f	Pack. pcs	Weight kg/100 pcs.	Item No.
<b>TV 4+1</b>	SAT-F	0,5 - 2,8 GHz	1	37.000	<b>5083 40 0</b>

/pc.

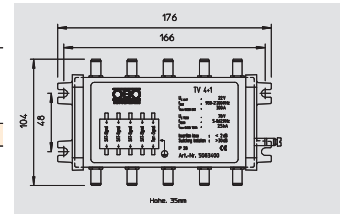

Surge protection device for data and information technology

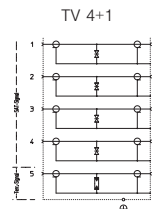

Maximum continuous voltage V <sub>c</sub>   SAT inputs	U <sub>c</sub>	V	22
Maximum continuous voltage V <sub>c</sub>   terrestrial input	U <sub>c</sub>	V	70
Lightning protection Zone LPZ			1→3
Nominal discharge current   SAT inputs	I <sub>n</sub>	A	300
Lightning impulse current   terrestrial input	I <sub>imp</sub>	kA	1
Transmission frequency	f		0,5 - 2,8 GHz
Reflux loss		dB	14 at 2.7 GHz
Protection level   terrestrial input with C2 (0.25 kA 8/20)		V	≤500
Protection level   SAT inputs with C2 (0.25 kA 8/20)	U <sub>p</sub>	V	≤45
Connection system			SAT-F
Temperature range	θ	°C	-40 - +80
<b>Item No.</b>			<b>5083 40 0</b>



## Surge protection devices for network technology: the plus of the Net Defender

- +Connectable protection device
- +High-performance surge protection
- +Usable in the "Channel Link" up to 10 GBit
- +Supports Power over Ethernet to 1 A
- +Testing protocol available



The "Net Defender" permits the use of Power over Ethernet with nominal currents of up to 1 A and optimised surge protection in the channel up to 10 GBit/s. This corresponds to a Channel Performance according to ISO/IEC 11801 Amd. 2 of Class EA or CAT 6A to TIA/ANSI. Of course, reverse compatibility is also guaranteed. To ensure easy installation, the "Net Defender" can be snapped directly onto the hat rail and uses it to create the necessary equipotential bonding. Alternatively, terminal protection using a separately connectable earthing line is possible.



# Surge protection for network technology

PoE LPZ 1→3 Cat 6<sub>A</sub> Class E<sub>A</sub>



## Surge protection for high-speed networks up to 10 GBit (Class EA/CAT6A)

Type	Version	Connection system	Pack. pcs	Weight kg/100 pcs.	Item No.
ND-CAT6A/EA	8-pole	RJ45	1	16.600	5081 80 0

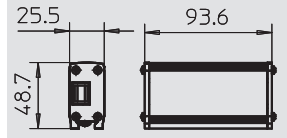

- High-quality RJ-45 sockets
- Support for Power over Ethernet + to 1 A
- Tested transmission quality in networks up to 10 GBit (Class EA) and CAT6A
- Rapid installation through connectable design

/pc.

LPZ 1→3 Cat 5



## Fine protection for Ethernet networks (Class D/CAT 5)

Type	Version	Connection system	Pack. pcs	Weight kg/100 pcs.	Item No.
RJ45 S-ATM 8-F	Fine protection	RJ45	1	14.000	5081 79 3

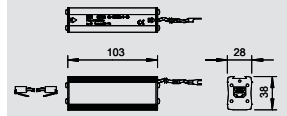

- Usable in networks of Class D or CAT 5
- Can be locked onto hat profile rails or mounted directly at the terminal
- Simple installation using RJ45 connection technology
- Optimised transmission properties

/pc.

LPZ 0→3



## Combination arrestor for 10Base2-/10Base5 networks

Type	Version	Connection system	Pack. pcs	Weight kg/100 pcs.	Item No.
KOAX B-E2 MF-C	Combined protection	TAE-N	1	10.300	5082 41 2

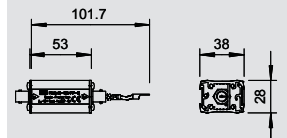

- In aluminium housing
- BNC connector for Cheapernet, 10BASE2
- Simple mounting with adapter connector
- Two-stage protection circuit

/pc.

LPZ 0→3



## Fine protection for 10Base2-/10Base5 networks

Type	Version	Connection system	Pack. pcs	Weight kg/100 pcs.	Item No.
KOAX B-E2 MF-F	Fine protection	TAE-N	1	9.800	5082 42 0

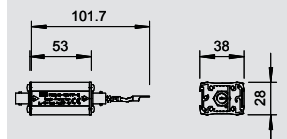

- In aluminium housing
- BNC connector for Cheapernet, 10BASE2
- Simple mounting with adapter connector
- Two-stage protection circuit

/pc.

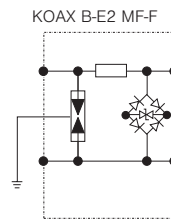
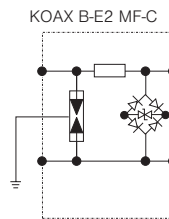
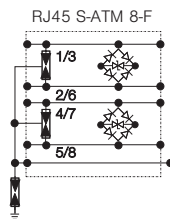
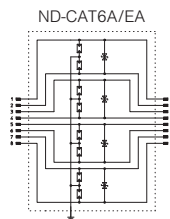

U max AC	U <sub>c</sub> AC	V	41	4.2	4.2	4.2
U max DC	U <sub>c</sub> DC	V	58	6	6.2	6.2
Lightning protection Zone LPZ			1→3	1→3	0→3	1→3
Channel performance ISO/IEC			Class EA	Class D	Class D	Class D
Channel performance Ansi/EA			58 B	6 B	6,2 B	6,2 B
Total impulse durability into C2 (8/20)		kA	7	5	10	10
Impulse durability int C2 (wire-wire)		kA	0.15	0.25	0.5	0.5
Voltage protection level line-earth		V	<700	< 800	< 500	< 500
Voltage protection level line-line		V	<120	< 12	< 12	< 12
Rated current	I <sub>L</sub>	A	1		0.2	0.2
Serial impedance per wire	f <sub>0</sub>	Ω			5	5
Transmission frequency	f		500 MHz	> 155 MHz	< 113 MHz	< 200 MHz
Degree of protection of enclosure			IP10	IP40	IP40	IP40
Connection system			RJ45	RJ45	TAE-N	TAE-N
Testing standard			IEC 61643-21	IEC 61643-21	IEC 61643-21	IEC 61643-21
<b>Item No.</b>			<b>5081 80 0</b>	<b>5081 79 3</b>	<b>5082 41 2</b>	<b>5082 42 0</b>



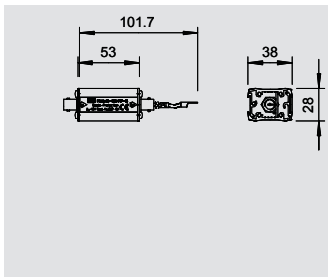

## Data cable protection device for coaxial TV / camera systems



Type	Version	Connection system	Pack.	Weight	Item No.
			pcs	kg/100 pcs.	
<b>KoaxB-E2 FF-F</b>	Fine protection	BNC, 50 Ohm	1	14.400	<b>5082 42 2</b>

/pc.

- Usable in CCTV and diverse TV systems
- Optimised transmission properties
- Can be locked onto hat profile rail
- Simple connection technology

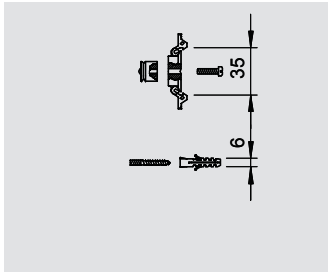

## Fastening set for hat profile rail



Type	Version	Pack.	Weight	Item No.
		pcs	kg/100 pcs.	
<b>DLS-BS</b>	For mounting: • Coax B-E2/... • Coax N-E5/... • RJ 11-Tele/4... • RJ 45 S-...	1	5.000	<b>5082 38 2</b>

/pc.

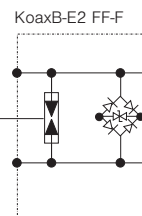

U max AC	U <sub>c</sub> AC	V	4.2
U max DC	U <sub>c</sub> DC	V	6.2
Lightning protection Zone LPZ			1-3
Nominal discharge current (8/20)	I <sub>n</sub>	kA	10 / 0,5
Voltage protection level line-earth		V	< 500
Voltage protection level line-line		V	< 12
Insertion loss	a/dB	dB	14 @ 60 MHz
Serial impedance per wire	f <sub>g</sub>	Ω	0
Degree of protection of enclosure			IP40
Connection system			BNC, 50 Ohm
Testing standard			IEC 61643-21
<b>Item No.</b>			<b>5082 42 2</b>



# Surge protection for data technology



Data cable protection device for information technology systems

- In aluminium housing
- RJ 45 Connector
- Incl. 150 mm connecting cable with RJ 45 connectors
- Simple mounting using adapter plug
- Two-stage protective circuit

Application: Twisted pair, control circuits, communication cables

## Basic protection for 4-wire information technology systems with RJ45



Type	Version	Connection system	Pack. pcs	Weight kg/100 pcs.	Item No.
<b>RJ45 S-E100 4-B</b>	Basic protection, 4 wires	RJ45	1	14.000	<b>5081 72 6</b>

/pc.

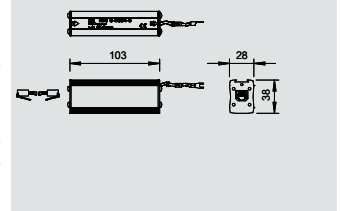

## Combination arrestor for 4-wire information technology systems with RJ45



Type	Version	Connection system	Pack. pcs	Weight kg/100 pcs.	Item No.
<b>RJ45 S-E100 4-C</b>	Combined protection, 4 wires	RJ45	1	14.000	<b>5081 73 4</b>

/pc.

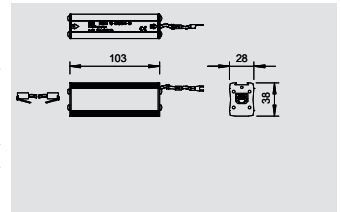

## Fine protection for 4-wire information technology systems with RJ45



Type	Version	Connection system	Pack. pcs	Weight kg/100 pcs.	Item No.
<b>RJ45 S-E100 4-F</b>	Fine protection, 4 wires	RJ45	1	14.000	<b>5081 74 2</b>

/pc.

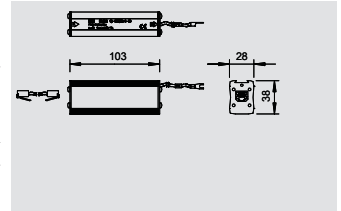

RJ45 S-E100 4-B

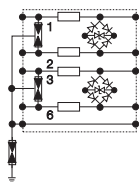

RJ45 S-E100 4-C

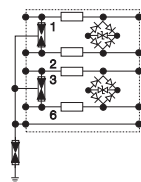

RJ45 S-E100 4-F

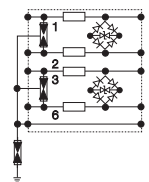

U max AC	U <sub>c</sub> AC	V	122	4.2	4.2
U max DC	U <sub>c</sub> DC	V	170	6.2	6.2
Lightning protection Zone LPZ			0→2	0→2	2→3
Impulse discharge current (10/350)	I <sub>imp</sub>	kA	1,5	1,5	-
Nominal discharge current (8/20)	I <sub>n</sub>	kA	7,5	7,5	7,5 / 0,5
Transmission frequency	f		155 MHz	70 MHz	100 MHz
Insertion loss	a/dB	dB	0,3 @ 100 MHz	5 @ 100 MHz	3 @ 100 MHz
Series resistance	R	ohm	-	4,7	-
Protection level (sym.) with In C2			≤500 V	≤12 V	≤12 V
Protection level (asym.) with In C2			≤800 V	≤800 V	≤800 V
Protection level (asym.) with 1 kV/μs C3			≤500 V	≤8 V	≤8 V
Degree of protection of enclosure			IP 40	IP 40	IP 40
Connection system			RJ45	RJ45	RJ45
<b>Item No.</b>			<b>5081 72 6</b>	<b>5081 73 4</b>	<b>5081 74 2</b>



Data cable protection device for information technology systems



- In aluminium housing
- RJ 45 Connector
- Incl. 150 mm connecting cable with RJ 45 connectors
- Simple mounting using adapter plug
- Two-stage protective circuit

Application: Twisted pair, control circuits, communication cables

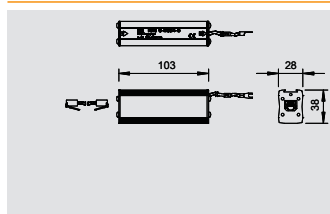

## Fine protection for 4-wire information technology systems RJ45

Type	Version	Connection system	Pack.	Weight	Item No.
			pcs	kg/100 pcs.	
<b>RJ45S-V24T 4-F</b>	Fine protection, 4 wires	RJ45	1	14.000	<b>5081 64 5</b>

/pc.

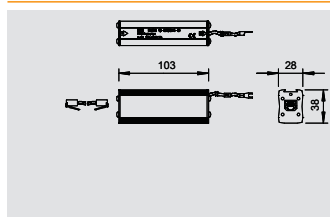

## Fine protection for 8-wire information technology systems RJ45

Type	Version	Connection system	Pack.	Weight	Item No.
			pcs	kg/100 pcs.	
<b>RJ45S-V24T 8-F</b>	Fine protection, 8 wires	RJ45	1	14.000	<b>5081 64 7</b>

/pc.



RJ45S-V24T 4-F

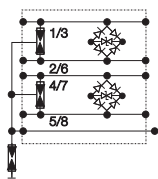

RJ45S-V24T 8-F

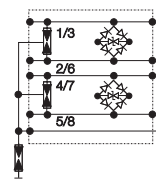

U max AC	U <sub>c</sub> AC	V	10	10
U max DC	U <sub>c</sub> DC	V	15	15
Lightning protection Zone LPZ			2→3	2→3
Nominal discharge current (8/20)	I <sub>n</sub>	kA	7,5 / 0,25	7,5 / 0,15
Protection level (sym.) with In C2			≤30 V	≤30 V
Protection level (asym.) with In C2			≤800 V	≤800 V
Protection level (asym.) with 1 kV/μs C3			≤25 V	≤25 V
Degree of protection of enclosure			IP40	IP40
Connection system			RJ45	RJ45
<b>Item No.</b>			<b>5081 64 5</b>	<b>5081 64 7</b>



## Product family, surge protection for serial interfaces

- + Connectable protection device
- + High-performance surge protection
- + Various interfaces available
- + Low protection level

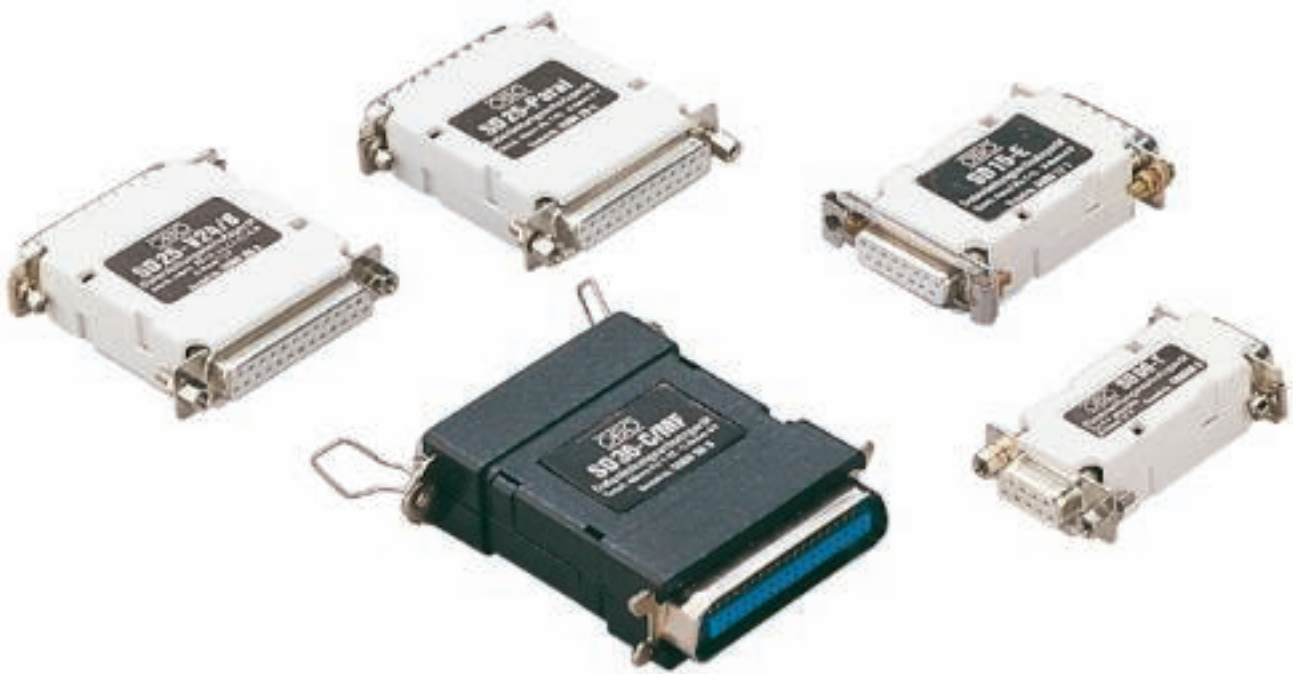

Serial interfaces are regularly found in industrial applications. Whether RS-232 or RS-422, depending on the connection system, OBO Bettermann can offer easy to install surge protection. Depending on the interface, these components are switched into the appropriate system in series, thus offering protection against the coupling of surge voltages between data cables.



Data cable protection devices, serial interface



- Different connection systems available
- Low protection level

Application: PLC, alarm systems, controllers

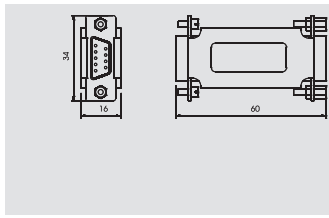

### Fine protection for 9-pin RS232 interface

Type	Max. continuous operating voltage V	Version	Pack. pcs	Weight kg/100 pcs.	Item No.
<b>SD09-V24 9</b>	18	SUB-D-9; V24 RS232	1	6.000	<b>5080 05 3</b>

/pc.

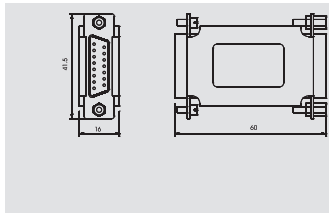

### Fine protection for 15-pin RS232 interface

Type	Max. continuous operating voltage V	Version	Pack. pcs	Weight kg/100 pcs.	Item No.
<b>SD15-V24 15</b>	18	SUB-D-15; V24 RS232	1	7.000	<b>5080 15 0</b>

/pc.

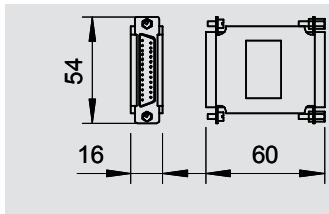

### Fine protection for 25-pin RS232 interface

Type	Max. continuous operating voltage V	Version	Pack. pcs	Weight kg/100 pcs.	Item No.
<b>SD25-V24 25</b>	18	SUB-D-25; V24 RS232	1	8.000	<b>5080 27 4</b>

/pc.

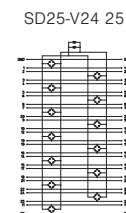
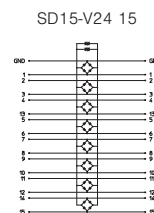
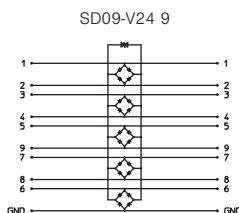

	SD09-V24 9	SD15-V24 15	SD25-V24 25
Max. continuous operating voltage	18	18	18
Lightning protection Zone LPZ	2-3	2-3	2-3
Nominal discharge current (8/20)	0.34	0.34	0.34
Protection level (sym.) with In C2	≤50 V	≤50 V	≤50 V
Protection level (asym.) with In C2	≤50 V	≤50 V	≤50 V
Protection level (asym.) with 1 kV/μs C3	≤25 V	≤25 V	≤25 V
Connection system	D-Sub 9 pole	D-Sub 15 pole	D-Sub 25 pole
<b>Item No.</b>	<b>5080 05 3</b>	<b>5080 15 0</b>	<b>5080 27 4</b>



# Surge protection for serial interfaces



Data cable protection devices, serial interface

- Different connection systems available
- Low protection level

Application: PLC, alarm systems, controllers



## Fine protection for 9-pin RS485 interface

Type	Max. continuous operating voltage V	Version	Pack. pcs	Weight kg/100 pcs.	Item No.
<b>SD09-V11 9</b>	7.5	SUB-D-9; V11 RS485	1	6.000	<b>5080 06 1</b>

/pc.

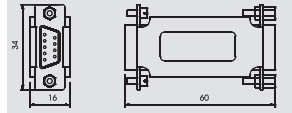

## Fine protection for 25-pin RS485 interface

Type	Max. continuous operating voltage V	Version	Pack. pcs	Weight kg/100 pcs.	Item No.
<b>SD25-V11 25</b>	7.5	SUB-D-25; V11 RS485	1	8.000	<b>5080 28 2</b>

/pc.

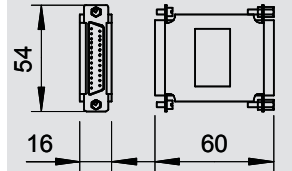

Surge protection device for data and information technology

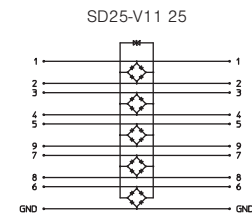
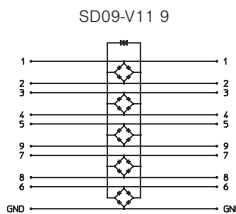

Max. continuous operating voltage	$U_c$	V	7.5	7.5
Lightning protection Zone LPZ			2-3	2-3
Nominal discharge current (8/20)	$I_n$	kA	0.75	0.75
Protection level (sym.) with In C2			≤100 V	≤100 V
Protection level (asym.) with In C2			≤100 V	≤100 V
Protection level (asym.) with 1 kV/μs C3			≤10 V	≤10 V
Connection system			D-Sub 9 pole	D-Sub 25 pole
<b>Item No.</b>			<b>5080 06 1</b>	<b>5080 28 2</b>



Data cable protection device, serial interface



- Screwless terminal connections
- Direct installation in the cable compartment
- Adhesive Velcro connection included

Application: direction installation in the cable compartment

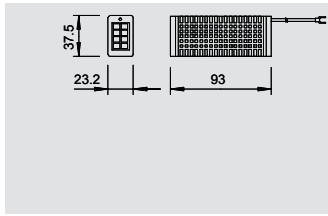

### Fine protection for RS232 with screwless terminals

Type	Max. continuous operating voltage V	Version	Connection system	Pack. pcs	Weight kg/100 pcs.	Item No.
<b>ASP-V24T 4</b>	18	4 pole, V24	Terminal	1	7.500	<b>5083 06 0</b>



/pc.

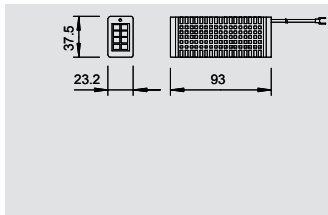

### Fine protection for RS485 with screwless terminals

Type	Max. continuous operating voltage V	Version	Connection system	Pack. pcs	Weight kg/100 pcs.	Item No.
<b>ASP-V11EI 4</b>	7.5	4 pole, V11	Terminal	1	7.500	<b>5083 08 7</b>



/pc.

ASP-V24T 4

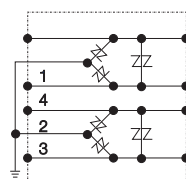

ASP-V11EI 4

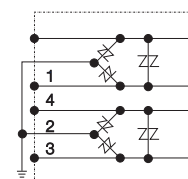

Max. continuous operating voltage	$U_c$	V	18	7.5
Lightning protection Zone LPZ			2→3	2→3
Nominal discharge current (8/20)	$I_n$	kA	0.34	0.75
Protection level (sym.) with In C2			≤65 V	≤110 V
Protection level (asym.) with In C2			≤55 V	≤120 V
Protection level (asym.) with 1 kV/μs C3			≤25 V	≤10 V
Connection system			Terminal	Terminal
<b>Item No.</b>			<b>5083 06 0</b>	<b>5083 08 7</b>





## Fine power protection, series installation: the plus of the VF family

- +High arresting capacity
- +Low protection level
- +Usable in AC/DC applications
- +Simple mounting using screwless terminals
- +UL-listed



The lightning barriers of type VF are fine protection devices, used for single-phase energy technology systems. Besides the low protection level, these devices also have a visual display, which will indicate defective surge protection. If required, remote signalling is also available using a changeover contact and an NC contact.

# MCR protection for 2-pin for power supply

Surge protection device, fine protection type 3 for distributor installation

- Suitable for DC and AC voltage systems
- With visual function display
- With installation-friendly, screwless connection terminals
- In a space-saving 17.5 mm grid
- Y connection

Application: Universal use on 35 mm U-rail in every normal commercially available distribution housing.

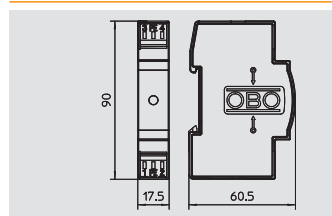

## MCR protection for 2-pin for power supply, 12 V

Type	Version	U max AC V	U max DC V	Pack. pcs	Weight kg/100 pcs.	Item No.
<b>VF12-AC DC</b>	12 V version	13.5	18	1	9.000	<b>5097 45 3</b>

/pc.

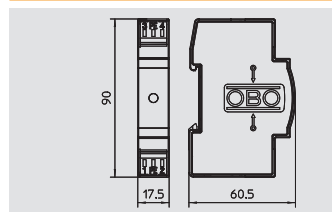

## MCR protection for 2-pin for power supply, 24 V

Type	Version	U max AC V	U max DC V	Pack. pcs	Weight kg/100 pcs.	Item No.
<b>VF24-AC/DC</b>	24 V version	34	46	1	8.000	<b>5097 60 7</b>

/pc.

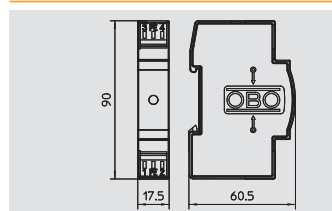

## MCR protection for 2-pin for power supply, 48 V

Type	Version	U max AC V	U max DC V	Pack. pcs	Weight kg/100 pcs.	Item No.
<b>VF48-AC/DC</b>	48 V version	60	80	1	8.000	<b>5097 61 5</b>

/pc.

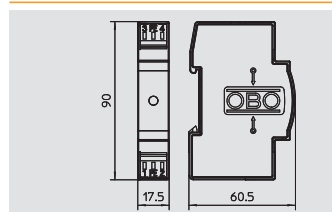

## MCR protection for 2-pin for power supply, 60 V

Type	Version	U max AC V	U max DC V	Pack. pcs	Weight kg/100 pcs.	Item No.
<b>VF60-AC/DC</b>	60 V version	80	110	1	8.000	<b>5097 62 3</b>

/pc.

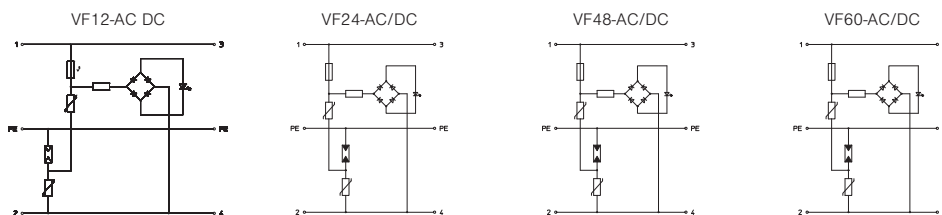

			VF12-AC DC	VF24-AC/DC	VF48-AC/DC	VF60-AC/DC
U max AC	U <sub>c</sub> AC	V	13.5	34	60	80
U max DC	U <sub>c</sub> DC	V	18	46	80	110
SPD to EN 61643-11			Type 3	Type 3	Type 3	Type 3
SPD to IEC 61643-11			class III	class III	class III	class III
Lightning protection Zone LPZ			2→3	2→3	2→3	2→3
Nominal discharge current (8/20)	I <sub>n</sub>	kA	0.7	0.7	0.7	0.7
Rated current	I <sub>L</sub>	A	20	20	20	20
Voltage protection level line-line		V	<110	<130	<220	<280
Voltage protection level line-earth		V	<1200	<1200	<1200	<1200
Response time	t <sub>A</sub>	ns	< 25	< 25	< 25	< 25
Temperature range	θ	°C	-40 - +80	-40 - +80	-40 - +80	-40 - +80
Degree of protection of enclosure			IP 20	IP 20	IP 20	IP 20
Division unit TE (17.5 mm)			1	1	1	1
Connection cross-section, rigid		mm <sup>2</sup>	0,14 - 2,5	0,14 - 2,5	0,14 - 2,5	0,14 - 2,5
Connection cross-section, multi-wire		mm <sup>2</sup>	0,14 - 2,5	0,14 - 2,5	0,14 - 2,5	0,14 - 2,5
Connection cross-section, flexible		mm <sup>2</sup>	0,14 - 2,5	0,14 - 2,5	0,14 - 2,5	0,14 - 2,5
<b>Item No.</b>			<b>5097 45 3</b>	<b>5097 60 7</b>	<b>5097 61 5</b>	<b>5097 62 3</b>



# MCR protection for 2-pin for power supply



Surge protection device, fine protection type 3 for distributor installation

- Suitable for DC and AC voltage systems
- With visual function display
- With installation-friendly, screwless connection terminals
- In a space-saving 17.5 mm grid
- Y connection

Application: Universal use on 35 mm U-rail in every normal commercially available distribution housing.



## MCR protection for 2-pin for power supply, 110 V

Type	Version	U max AC V	U max DC V	Pack. pcs	Weight kg/100 pcs.	Item No.
<b>VF110-AC DC</b>	110 V version	150	200	1	8.000	<b>5097 63 1</b>

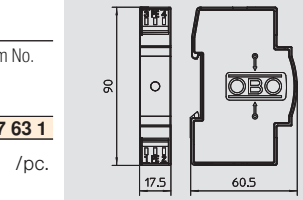

/pc.



## MCR protection for 2-pin for power supply, 230 V

Type	Version	U max AC V	U max DC V	Pack. pcs	Weight kg/100 pcs.	Item No.
<b>VF230-AC/DC</b>	230 V version	255	350	1	8.000	<b>5097 65 0</b>

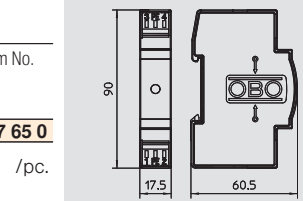

/pc.

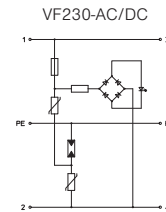
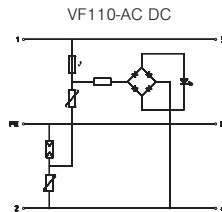

U max AC	U <sub>c</sub> AC	V	150	255
U max DC	U <sub>c</sub> DC	V	200	350
SPD to EN 61643-11			Type 3	Type 3
SPD to IEC 61643-11			class III	class III
Lightning protection Zone LPZ			2-3	2-3
Nominal discharge current (8/20)	I <sub>n</sub>	kA	2	2.5
Rated current	I <sub>L</sub>	A	20	20
Voltage protection level line-line		V	<500	<1000
Voltage protection level line-earth		V	<1400	<1400
Response time	t <sub>A</sub>	ns	<25	<25
Temperature range	θ	°C	-40 - +80	-40 - +80
Degree of protection of enclosure			IP 20	IP 20
Division unit TE (17.5 mm)			1	1
Connection cross-section, rigid		mm <sup>2</sup>	0,14 - 2,5	0,14 - 2,5
Connection cross-section, multi-wire		mm <sup>2</sup>	0,14 - 2,5	0,14 - 2,5
Connection cross-section, flexible		mm <sup>2</sup>	0,14 - 2,5	0,14 - 2,5
<b>Item No.</b>			<b>5097 63 1</b>	<b>5097 65 0</b>



# MCR protection for 2-pin for power supply with remote signalling

Surge protection device, fine protection type 3 for distributor installation

- Suitable for DC and AC voltage systems
- With visual function display
- With installation-friendly, screwless connection terminals
- In a space-saving 17.5 mm grid
- Y connection

Application: Universal use on 35 mm U-rail in every normal commercially available distribution housing.

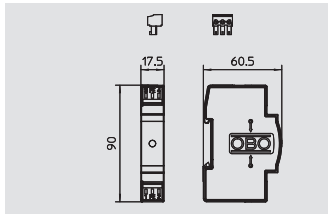

## MCR protection for 2-pin for power supply with remote signalling, 12 V AC/DC

Type	U max DC V	U max AC V	Pack. pcs	Weight kg/100 pcs.	Item No.
<b>VF12-AC/DC-FS</b>	18	13.5	1	6.400	<b>5097 45 4</b>

/pc.

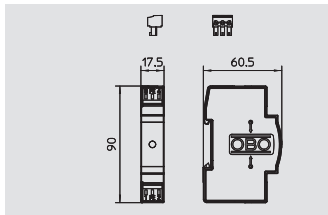

## MCR protection for 2-pin for power supply with remote signalling, 24 V AC/DC

Type	U max DC V	U max AC V	Pack. pcs	Weight kg/100 pcs.	Item No.
<b>VF24-AC/DC-FS</b>	46	34	1	6.620	<b>5097 82 0</b>

/pc.

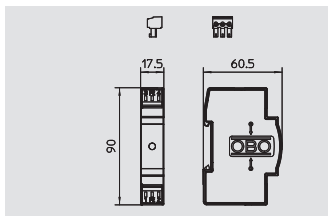

## MCR protection for 2-pin for power supply with remote signalling, 48 V AC/DC

Type	U max DC V	U max AC V	Pack. pcs	Weight kg/100 pcs.	Item No.
<b>VF48-AC/DC-FS</b>	80	60	1	6.630	<b>5097 82 2</b>

/pc.

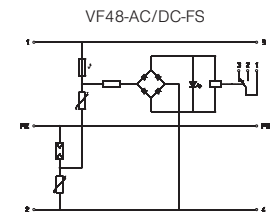
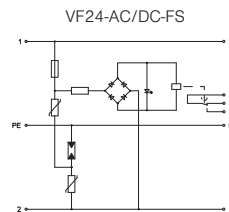
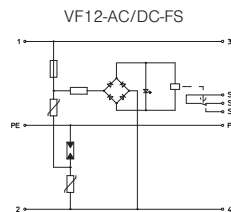

	VF12-AC/DC-FS	VF24-AC/DC-FS	VF48-AC/DC-FS	
U max AC	U <sub>c AC</sub> V	13.5	34	60
U max DC	U <sub>c DC</sub> V	18	46	80
SPD to EN 61643-11		Type 3	Type 3	Type 3
SPD to IEC 61643-11		class III	class III	class III
Lightning protection Zone LPZ		2-3	2-3	2-3
Nominal discharge current (8/20)	I <sub>n</sub> kA	0,7	0,7	0,7
Rated current	I <sub>L</sub> A	20	20	20
Voltage protection level line-line	V	<110	<160	<220
Voltage protection level line-earth	V	<1200	<1200	<1200
Response time	t <sub>A</sub> ns	< 25	< 25	< 25
Temperature range	θ °C	-40 - +80	-40 - +80	-40 - +80
Degree of protection of enclosure		20	IP 20	IP 20
Division unit TE (17.5 mm)		1	1	1
Connection cross-section, rigid	mm <sup>2</sup>	0,14 - 2,5	0,14 - 2,5	0,14 - 2,5
Connection cross-section, multi-wire	mm <sup>2</sup>	0,14 - 2,5	0,14 - 2,5	0,14 - 2,5
Connection cross-section, flexible	mm <sup>2</sup>	0,14 - 2,5	0,14 - 2,5	0,14 - 2,5
<b>Item No.</b>		<b>5097 45 4</b>	<b>5097 82 0</b>	<b>5097 82 2</b>



# MCR protection for 2-pin for power supply with remote signalling



Surge protection device, fine protection type 3 for distributor installation

- Suitable for DC and AC voltage systems
- With visual function display
- With installation-friendly, screwless connection terminals
- In a space-saving 17.5 mm grid
- Y connection

Application: Universal use on 35 mm U-rail in every normal commercially available distribution housing.



## MCR protection for 2-pin for power supply with remote signalling, 60 V AC

Type	U max DC V	U max AC V	Pack. pcs	Weight kg/100 pcs.	Item No.
<b>VF60-AC/DC-FS</b>	110	80	1	6.900	<b>5097 82 4</b>

/pc.

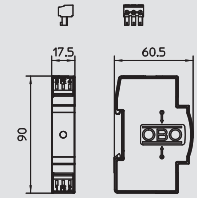

## MCR protection for 2-pin for power supply with remote signalling, 110 V AC/DC

Type	U max DC V	U max AC V	Pack. pcs	Weight kg/100 pcs.	Item No.
<b>VF110-AC DC-FS</b>	200	150	1	6.600	<b>5097 84 6</b>

/pc.

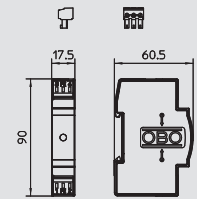

## MCR protection for 2-pin for power supply with remote signalling, 230 V AC

Type	U max DC V	U max AC V	Pack. pcs	Weight kg/100 pcs.	Item No.
<b>VF230-AC-FS</b>	—	255	1	6.910	<b>5097 85 8</b>

/pc.

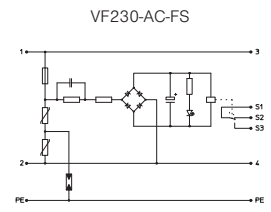
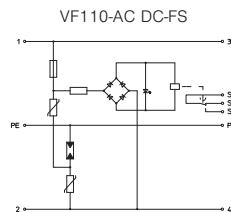
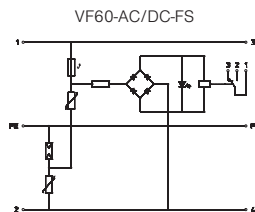
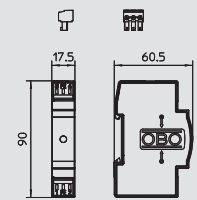

U max AC	U <sub>c</sub> AC	V	80	150	255
U max DC	U <sub>c</sub> DC	V	110	200	
SPD to EN 61643-11			Type 3	Type 3	Type 3
SPD to IEC 61643-11			class III	class III	class III
Lightning protection Zone LPZ			2→3	2→3	2→3
Nominal discharge current (8/20)	I <sub>n</sub>	kA	0.7	2	2.5
Rated current	I <sub>L</sub>	A	20	20	20
Voltage protection level line-line		V	<280	<500	<1060
Voltage protection level line-earth		V	<1200	<1300	<1400
Response time	t <sub>A</sub>	ns	<25	<25	<25
Temperature range	θ	°C	-40 - +80	-40 - +80	-40 - +80
Degree of protection of enclosure			IP 20	IP 20	IP 20
Division unit TE (17.5 mm)			1	1	1
Connection cross-section, rigid		mm <sup>2</sup>	0,14 - 2,5	0,14 - 2,5	0,14 - 2,5
Connection cross-section, multi-wire		mm <sup>2</sup>	0,14 - 2,5	0,14 - 2,5	0,14 - 2,5
Connection cross-section, flexible		mm <sup>2</sup>	0,14 - 2,5	0,14 - 2,5	0,14 - 2,5
<b>Item No.</b>			<b>5097 82 4</b>	<b>5097 84 6</b>	<b>5097 85 8</b>



# MCR protection for 2-pin for power supply with leak current-free remote signalling

Type 3 surge protection/fine network protection with leak current-free remote signalling

- With remote signalling: potential-free NC contact for function monitoring
- With installation-friendly, screwless connection terminals
- In space-saving 17.5 mm grid
- Y circuit

Application: Universal use on 35 mm hat profile rails in any standard distributor housing.

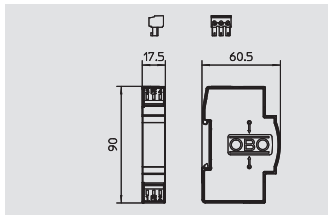

## MCR protection for 2-pin for power supply with leak current-free remote signalling, 24 V AC/DC

Type	U max AC V	U max DC V	Pack. pcs	Weight kg/100 pcs.	Item No.
<b>VF2-24-AC/DC-FS</b>	34	46	1	6.000	<b>5097 93 1</b>

/pc.

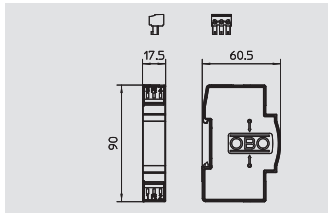

## MCR protection for 2-pin for power supply with leak current-free remote signalling, 110 V AC/DC

Type	U max AC V	U max DC V	Pack. pcs	Weight kg/100 pcs.	Item No.
<b>VF2-110-AC/DCFS</b>	150	200	1	6.000	<b>5097 93 5</b>

/pc.

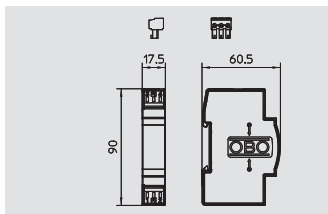

## MCR protection for 2-pin for power supply with leak current-free remote signalling, 230 V AC/DC

Type	U max AC V	U max DC V	Pack. pcs	Weight kg/100 pcs.	Item No.
<b>VF2-230-AC/DC-FS</b>	255	350	1	6.000	<b>5097 93 9</b>

/pc.

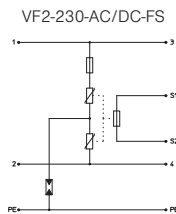
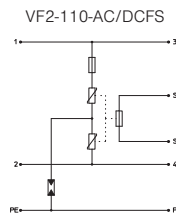
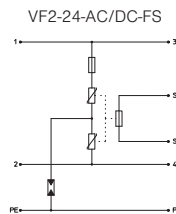

	VF2-24-AC/DC-FS	VF2-110-AC/DCFS	VF2-230-AC/DC-FS
U max AC	34	150	255
U max DC	46	200	350
SPD to EN 61643-11	Type 3	Type 3	Type 3
SPD to IEC 61643-11	class III	class III	class III
Lightning protection Zone LPZ	2-3	2-3	2-3
Nominal discharge current (8/20)	2.5	2.5	2.5
Rated current	20	20	20
Voltage protection level line-line	< 130	< 220	< 1000
Voltage protection level line-earth	< 1200	< 1200	< 1400
Response time	<25	<25	<25
Temperature range	-40 - +80	-40 - +80	-40 - +80
Degree of protection of enclosure	IP 20	IP 20	IP 20
Division unit TE (17.5 mm)	1	1	1
Connection cross-section, rigid	0,14 - 2,5	0,14 - 2,5	0,14 - 2,5
Connection cross-section, multi-wire	0,14 - 2,5	0,14 - 2,5	0,14 - 2,5
Connection cross-section, flexible	0,14 - 2,5	0,14 - 2,5	0,14 - 2,5
<b>Item No.</b>	<b>5097 93 1</b>	<b>5097 93 5</b>	<b>5097 93 9</b>



## MSR protection for two-core systems: the plus of the FRD/FLD family

- +High arresting capacity
- +Low protection level
- +Universally usable
- +Simple mounting using screwless terminals
- +High bandwidth
- +UL-listed



The use of lightning barriers in two-core wire systems is commonplace. These surge protection devices are used from telecommunication cables through bus systems up to measurement and control technology. Surge protection technology allows flexible protection for all kinds of applications. All the devices have both a low protection level and a high arresting capacity.



# MCR protection for two-core systems

Data cable protection devices for two-wire dual core systems

- Available as basic, medium and fine protection
- Low protection level at high current load
- Screwless terminals
- Bandwidth-optimised for secure transmission
- Quick mounting on hat rail or wall mounting



Application: Control systems, bus systems, communications systems

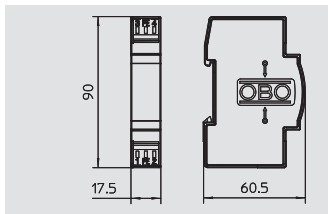

## Basic protection for two-core systems with HF applications 120 V

Type	Max. continuous operating voltage Vc/AC V	Max. continuous operating voltage Vc/DC V	Number of poles	Connection system	Pack. pcs	Weight kg/100 pcs.	Item No.
<b>TKS-B</b>	120	170	2	Terminal	1	4.400	<b>5097 97 6</b>

/pc.

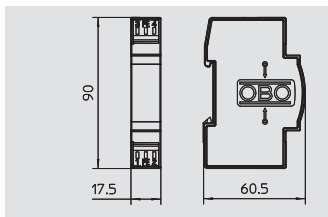
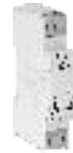

## Combination protection for two-core systems with HF applications 5 V

Type	Max. continuous operating voltage Vc/AC V	Max. continuous operating voltage Vc/DC V	Number of poles	Connection system	Pack. pcs	Weight kg/100 pcs.	Item No.
<b>FRD 5 HF</b>	4	6	2	Terminal	1	4.400	<b>5098 57 1</b>

/pc.

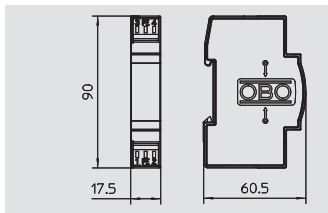

## Combination protection for two-core systems with HF applications 24 V

Type	Max. continuous operating voltage Vc/AC V	Max. continuous operating voltage Vc/DC V	Number of poles	Connection system	Pack. pcs	Weight kg/100 pcs.	Item No.
<b>FRD 24 HF</b>	19	28	2	Terminal	1	4.400	<b>5098 57 5</b>

/pc.

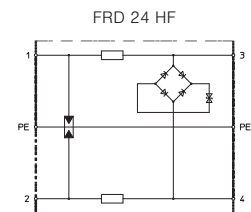
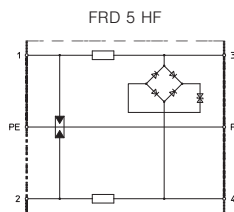
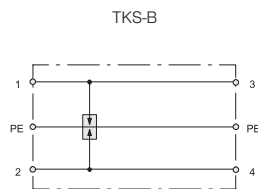

		TKS-B	FRD 5 HF	FRD 24 HF
Maximum continuous operating voltage Vc/AC	V	120	4	19
Maximum continuous operating voltage Vc/DC	V	170	6	28
Lightning protection Zone LPZ		0-3	0-3	0-3
Number of poles		2	2	2
Rated current	$I_L$ A	20	0.45	0.45
Serial impedance per path	$\Omega$	-	2,2 ± 10 %	2,2 ± 10 %
Impulse durability line-line		C2: 18 kV / 9 kA	C2: 18 kV / 9 kA	C2: 18 kV / 9 kA
Impulse durability line-earth		C2: 18 kV / 9 kA	C2: 18 kV / 9 kA	C2: 18 kV / 9 kA
Total impulse durability (10/350)	kA	D1: 6	D1: 6	D1: 6
Total impulse durability (8/20)	kA	18	18	18
Voltage protection level line-line	V	950	90	120
Voltage protection level line-earth	V	600	650	650
Shielding connection available		No	No	No
Shield connection		-	-	-
Temperature range	$\vartheta$ °C	-40 - +80	-40 - +80	-40 - +80
Division unit TE (17.5 mm)		1	1	1
Connection cross-section, flexible	mm <sup>2</sup>	0,14 - 2,5	0,14 - 2,5	0,14 - 2,5
Connection cross-section, multi-wire	mm <sup>2</sup>	0,14 - 2,5	0,14 - 2,5	0,14 - 2,5
Connection cross-section, rigid	mm <sup>2</sup>	0,14 - 2,5	0,14 - 2,5	0,14 - 2,5
Testing standard		IEC 61643-21	IEC 61643-21	IEC 61643-21
<b>Item No.</b>		<b>5097 97 6</b>	<b>5098 57 1</b>	<b>5098 57 5</b>



# MCR protection for two-core systems



Surge protection for use in measurement and control technology

- Medium and fine protection
- Standard design for double core systems
- Two-stage protection circuit
- With installation-friendly, screwless connection terminals
- In space-saving 17.5 mm grid
- With ohmic decoupling in the longitudinal branch

Application: Universal use on any 35 mm hat profile rail in every commercially available distributor housing.

## Medium and fine protection for two-core systems 5 V

Type	Max. continuous operating voltage Vc/AC V	Max. continuous operating voltage Vc/DC V	Number of poles	Connection system	Pack. pcs	Weight kg/100 pcs.	Item No.
<b>FRD 5</b>	5	8	2	Terminal	1	5.100	<b>5098 49 2</b>

/pc.

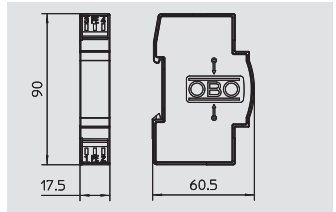

## Medium and fine protection for two-core systems 12 V

Type	Max. continuous operating voltage Vc/AC V	Max. continuous operating voltage Vc/DC V	Number of poles	Connection system	Pack. pcs	Weight kg/100 pcs.	Item No.
<b>FRD 12</b>	9	13	2	Terminal	1	5.100	<b>5098 50 6</b>

/pc.

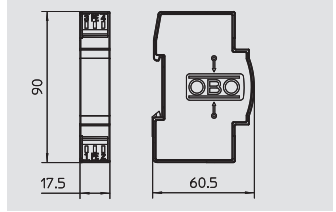

## Medium and fine protection for two-core systems 24 V

Type	Max. continuous operating voltage Vc/AC V	Max. continuous operating voltage Vc/DC V	Number of poles	Connection system	Pack. pcs	Weight kg/100 pcs.	Item No.
<b>FRD 24</b>	19	28	2	Terminal	1	5.100	<b>5098 51 4</b>

/pc.

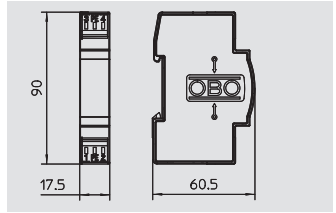

## Medium and fine protection for two-core systems 48 V

Type	Max. continuous operating voltage Vc/AC V	Max. continuous operating voltage Vc/DC V	Number of poles	Connection system	Pack. pcs	Weight kg/100 pcs.	Item No.
<b>FRD 48</b>	37	53	2	Terminal	1	5.100	<b>5098 52 2</b>

/pc.

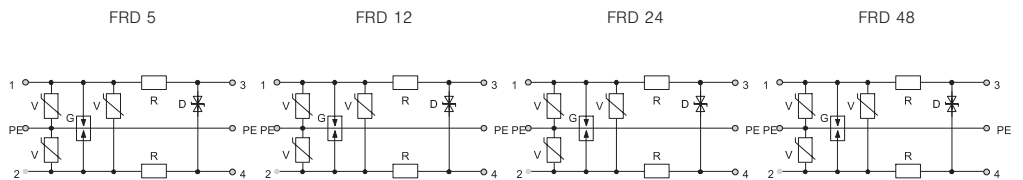
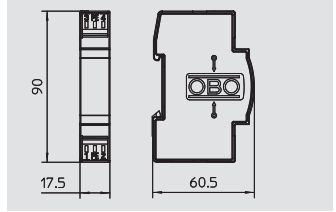

Maximum continuous operating voltage Vc/AC	V	5	9	19	37
Maximum continuous operating voltage Vc/DC	V	8	13	28	53
Lightning protection Zone LPZ		0-3	0-3	0-3	0-3
Number of poles		2	2	2	2
Rated current I <sub>L</sub>	A	0.2	0.2	0.2	0.2
Serial impedance per path	Ω	15 ± 10 %	15 ± 10 %	15 ± 10 %	0,14 ÷ 2,5
Impulse durability line-line		C1: 0.5 kV / 0.5 kA	C1: 1 kV / 0.5 kA	C2: 5 kV / 2.5 kA	C2: 5 kV / 2.5 kA
Impulse durability line-earth		C2: 10 kV / 5 kA	C2: 10 kV / 5 kA	C2: 10 kV / 5 kA	C2: 10 kV / 5 kA
Total impulse durability (10/350)	kA	D1: 3 kA	D1: 3	D1: 3	D1: 3
Total impulse durability (8/20)	kA	10	10	10	10
Voltage protection level line-line	V	15	30	60	140
Voltage protection level line-earth	V	600	600	600	600
Shielding connection available		No	No	No	No
Shield connection		-	-	-	-
Temperature range	θ °C	-40 - +80	-40 - +80	-40 - +80	-40 - +80
Division unit TE (17.5 mm)		1	1	1	1
Connection cross-section, flexible	mm <sup>2</sup>	0,14 - 2,5	0,14 - 2,5	0,14 - 2,5	0,14 - 2,5
Connection cross-section, multi-wire	mm <sup>2</sup>	0,14 - 2,5	0,14 - 2,5	0,14 - 2,5	0,14 - 2,5
Connection cross-section, rigid	mm <sup>2</sup>	0,14 - 2,5	0,14 - 2,5	0,14 - 2,5	0,14 - 2,5
Testing standard		IEC 61643-21	IEC 61643-21	IEC 61643-21	IEC 61643-21
<b>Item No.</b>		<b>5098 49 2</b>	<b>5098 50 6</b>	<b>5098 51 4</b>	<b>5098 52 2</b>



# MCR protection for two-core systems

Surge protection for use in measurement and control technology

- Medium and fine protection
- Standard design for double core systems
- Two-stage protection circuit
- With installation-friendly, screwless connection terminals
- In space-saving 17.5 mm grid
- With ohmic decoupling in the longitudinal branch



Application: Universal use on any 35 mm hat profile rail in every commercially available distributor housing.

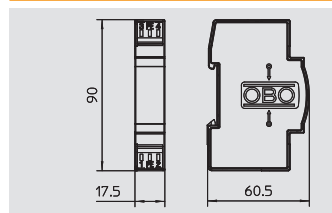

## Medium and fine protection for two-core systems 110 V

Type	Max. continuous operating voltage Vc/AC V	Max. continuous operating voltage Vc/DC V	Number of poles	Connection system	Pack. pcs	Weight kg/100 pcs.	Item No.
<b>FRD 110</b>	86	122	2	Terminal	1	5.100	<b>5098 55 7</b>

/pc.



FRD 110

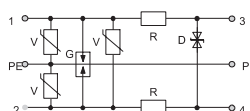

Maximum continuous operating voltage Vc/AC	V	86
Maximum continuous operating voltage Vc/DC	V	122
Lightning protection Zone LPZ		0-3
Number of poles		2
Rated current $I_L$	A	0.2
Serial impedance per path	$\Omega$	15 ± 10 %
Impulse durability line-line		C2: 5 kV / 2.5 kA
Impulse durability line-earth		C2: 10 kV / 5 kA
Total Impulse durability (10/350)	kA	D1: 3
Total Impulse durability (8/20)	kA	10
Voltage protection level line-line	V	300
Voltage protection level line-earth	V	600
Shielding connection available		No
Shield connection		-
Temperature range $\vartheta$	°C	-40 - +80
Division unit TE (17.5 mm)		1
Connection cross-section, flexible	mm <sup>2</sup>	0,14 - 2,5
Connection cross-section, multi-wire	mm <sup>2</sup>	0,14 - 2,5
Connection cross-section, rigid	mm <sup>2</sup>	0,14 - 2,5
Testing standard		IEC 61643-21
<b>Item No.</b>		<b>5098 55 7</b>



# MCR protection for two-core systems



Surge protection for use in measurement and control technology

- Medium and fine protection
- Standard design for single core systems
- Two-stage protection circuit
- With installation-friendly, screwless connection terminals
- In space-saving 17.5 mm grid
- With ohmic decoupling in the longitudinal branch

Application: Universal use on any 35 mm hat profile rail in every commercially available distributor housing.

## Medium and fine protection for two-core systems 5 V

Type	Max. continuous operating voltage Vc/AC V	Max. continuous operating voltage Vc/DC V	Number of poles	Connection system	Pack. pcs	Weight kg/100 pcs.	Item No.
<b>FRD 2-5</b>	5	8	2	Terminal	1	5.100	<b>5098 79 4</b>

/pc.

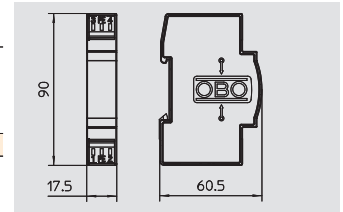

## Medium and fine protection for two-core systems 24 V

Type	Max. continuous operating voltage Vc/AC V	Max. continuous operating voltage Vc/DC V	Number of poles	Connection system	Pack. pcs	Weight kg/100 pcs.	Item No.
<b>FRD 2-24</b>	19	28	2	Terminal	1	5.100	<b>5098 72 7</b>

/pc.

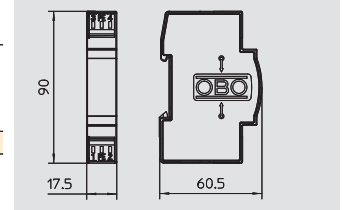

FRD 2-5

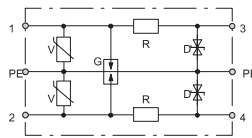

FRD 2-24

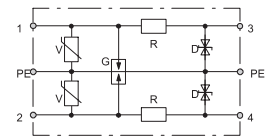

Maximum continuous operating voltage Vc/AC	V	5	19
Maximum continuous operating voltage Vc/DC	V	8	28
Lightning protection Zone LPZ		0-3	0-3
Number of poles		2	2
Rated current	$I_L$	A	0.2
Serial impedance per path	$\Omega$	$15 \pm 10 \%$	$15 \pm 10 \%$
Impulse durability line-line		C1: 1 kV / 0.5 kA	C2: 5 kV / 2.5 kA
Impulse durability line-earth		C1: 1 kV / 0.5 kA	C2: 5 kV / 2.5 kA
Total impulse durability	$I_{Total}$	kA	C2: 10kV / 5 kA
Voltage protection level line-line	V	30	120
Voltage protection level line-earth	V	15	60
Shielding connection available		No	No
Shield connection		-	-
Temperature range	$\vartheta$	°C	-40 - +80
Division unit TE (17.5 mm)		1	1
Connection cross-section, flexible	mm <sup>2</sup>	0,14 - 2,5	0,14 - 2,5
Connection cross-section, multi-wire	mm <sup>2</sup>	0,14 - 2,5	0,14 - 2,5
Connection cross-section, rigid	mm <sup>2</sup>	0,14 - 2,5	0,14 - 2,5
Testing standard		IEC 61643-21	IEC 61643-21
<b>Item No.</b>		<b>5098 79 4</b>	<b>5098 72 7</b>



# MCR protection for two-core systems

Surge protection for use in measurement and control technology



- Medium and fine protection
- Standard design for single core systems
- Two-stage protection circuit
- With installation-friendly, screwless connection terminals
- In space-saving 17.5 mm grid
- With inductive decoupling in the longitudinal branch

Application: Universal use on any 35 mm hat profile rail in every commercially available distributor housing.

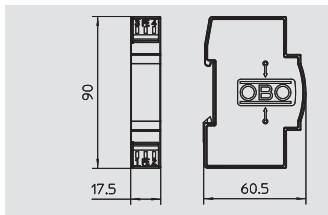

## Medium and fine protection for two-core systems 5 V

Type	Max. continuous operating voltage Vc/AC V	Max. continuous operating voltage Vc/DC V	Number of poles	Connection system	Pack. pcs	Weight kg/100 pcs.	Item No.
<b>FLD 5</b>	5	8	2	Terminal	1	5.200	<b>5098 60 0</b>

/pc.

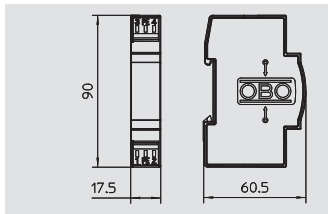

## Medium and fine protection for two-core systems 12 V

Type	Max. continuous operating voltage Vc/AC V	Max. continuous operating voltage Vc/DC V	Number of poles	Connection system	Pack. pcs	Weight kg/100 pcs.	Item No.
<b>FLD 12</b>	9	13	2	Terminal	1	5.200	<b>5098 60 3</b>

/pc.

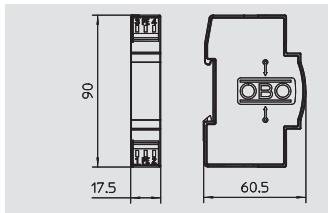

## Medium and fine protection for two-core systems 24 V

Type	Max. continuous operating voltage Vc/AC V	Max. continuous operating voltage Vc/DC V	Number of poles	Connection system	Pack. pcs	Weight kg/100 pcs.	Item No.
<b>FLD 24</b>	19	28	2	Terminal	1	5.200	<b>5098 61 1</b>

/pc.

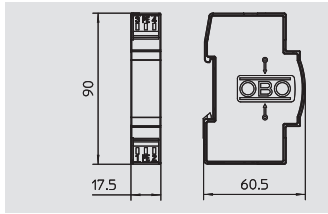

## Medium and fine protection for two-core systems 48 V

Type	Max. continuous operating voltage Vc/AC V	Max. continuous operating voltage Vc/DC V	Number of poles	Connection system	Pack. pcs	Weight kg/100 pcs.	Item No.
<b>FLD 48</b>	37	53	2	Terminal	1	5.200	<b>5098 63 0</b>

/pc.

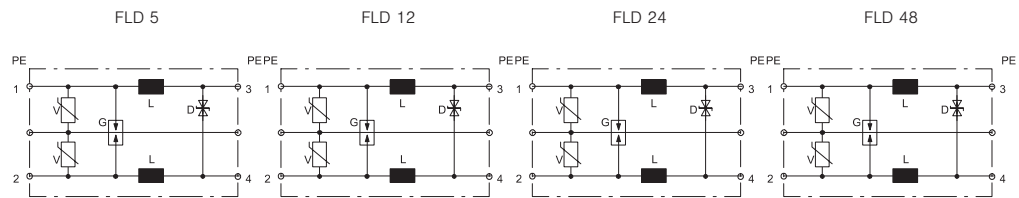

Maximum continuous operating voltage Vc/AC	V	5	9	19	37
Maximum continuous operating voltage Vc/DC	V	8	13	28	53
Lightning protection Zone LPZ		0→3	0→3	0→3	0→3
Number of poles		2	2	2	2
Rated current I <sub>L</sub>	A	1	1	1	1
Series inductance per path	μH	120 ± 20 %	120 ± 20 %	120 ± 20 %	120 ± 20 %
Impulse durability line-line		C1: 1 kV / 0.5 kA	C1: 1 kV / 0.5 kA	C1: 5 kV / 2.5 kA	C1: 5 kV / 2.5 kA
Impulse durability line-earth		C2: 10 kV / 5 kA	C2: 10 kV / 5 kA	C2: 10 kV / 5 kA	C2: 10 kV / 5 kA
Total impulse durability (10/350)	kA	D1: 3	D1: 3	D1: 3	D1: 3
Total impulse durability (8/20)	kA	10	10	10	10
Voltage protection level line-line	V	15	30	60	140
Voltage protection level line-earth	V	600	600	600	600
Shielding connection available		No	No	No	No
Shield connection		-	-	-	-
Temperature range θ	°C	-40 - +80	-40 - +80	-40 - +80	-40 - +80
Division unit TE (17.5 mm)		1	1	1	1
Connection cross-section, flexible	mm <sup>2</sup>	0,14 - 2,5	0,14 - 2,5	0,14 - 2,5	0,14 - 2,5
Connection cross-section, multi-wire	mm <sup>2</sup>	0,14 - 2,5	0,14 - 2,5	0,14 - 2,5	0,14 - 2,5
Connection cross-section, rigid	mm <sup>2</sup>	0,14 - 2,5	0,14 - 2,5	0,14 - 2,5	0,14 - 2,5
Testing standard		IEC 61643-21	IEC 61643-21	IEC 61643-21	IEC 61643-21
<b>Item No.</b>		<b>5098 60 0</b>	<b>5098 60 3</b>	<b>5098 61 1</b>	<b>5098 63 0</b>

Always indicate the item number when ordering.

# MCR protection for two-core systems



Surge protection for use in measurement and control technology

- Medium and fine protection
- Standard design for single core systems
- Two-stage protection circuit
- With installation-friendly, screwless connection terminals
- In space-saving 17.5 mm grid
- With inductive decoupling in the longitudinal branch

Application: Universal use on any 35 mm hat profile rail in every commercially available distributor housing.



## Medium and fine protection for two-core systems 60 V

Type	Max. continuous operating voltage $V_c/AC$ V	Max. continuous operating voltage $V_c/DC$ V	Number of poles	Connection system	Pack. pcs	Weight kg/100 pcs.	Item No.
<b>FLD 60</b>	65	93	2	Terminal	1	5.200	<b>5098 63 8</b>

/pc.

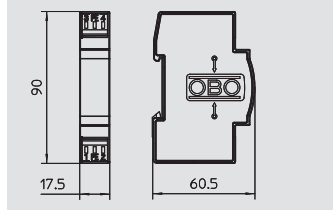

## Medium and fine protection for two-core systems 110 V

Type	Max. continuous operating voltage $V_c/AC$ V	Max. continuous operating voltage $V_c/DC$ V	Number of poles	Connection system	Pack. pcs	Weight kg/100 pcs.	Item No.
<b>FLD 110</b>	86	122	2	Terminal	1	5.200	<b>5098 64 6</b>

/pc.

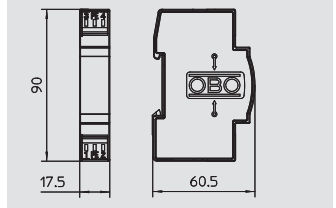

FLD 60

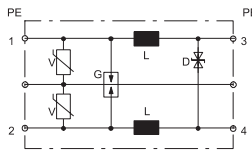

FLD 110

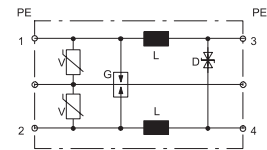

Maximum continuous operating voltage $V_c/AC$	V	65	86
Maximum continuous operating voltage $V_c/DC$	V	93	122
Lightning protection Zone LPZ		0-3	0-3
Number of poles		2	2
Rated current $I_L$	A	1	1
Series induction per path	$\mu H$	120 ± 20 %	120 ± 20 %
Impulse durability line-line		C1: 1 kV / 0.5 kA	C1: 1 kV / 0.5 kA
Impulse durability line-earth		C2: 10 kV / 5 kA	C1: 1 kV / 0.5 kA
Total impulse durability (10/350)	kA	D1: 3	D1: 3
Total impulse durability (8/20)	kA	10	10
Voltage protection level line-line	V	160	300
Voltage protection level line-earth	V	600	600
Shielding connection available		No	No
Shield connection		-	-
Temperature range $\vartheta$	°C	-40 - +80	-40 - +80
Division unit TE (17.5 mm)		1	1
Connection cross-section, flexible	mm <sup>2</sup>	0,14 - 2,5	0,14 - 2,5
Connection cross-section, multi-wire	mm <sup>2</sup>	0,14 - 2,5	0,14 - 2,5
Connection cross-section, rigid	mm <sup>2</sup>	0,14 - 2,5	0,14 - 2,5
Testing standard		IEC 61643-21	IEC 61643-21
<b>Item No.</b>		<b>5098 63 8</b>	<b>5098 64 6</b>



# MCR protection for two-core systems

Surge protection for use in measurement and control technology



- Medium and fine protection
- Standard design for single core systems
- Two-stage protection circuit
- With installation-friendly, screwless connection terminals
- In space-saving 17.5 mm grid
- With inductive decoupling in the longitudinal branch

Application: Universal use on any 35 mm hat profile rail in every commercially available distributor housing.

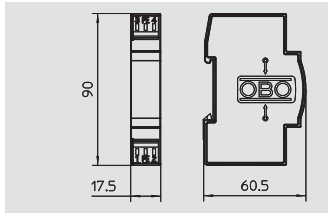

## Medium and fine protection for two-core systems 5 V

Type	Max. continuous operating voltage Vc/AC V	Max. continuous operating voltage Vc/DC V	Number of poles	Connection system	Pack. pcs	Weight kg/100 pcs.	Item No.
<b>FLD 2-5</b>	5	8	2	Terminal	1	5.100	<b>5098 86 7</b>

/pc.

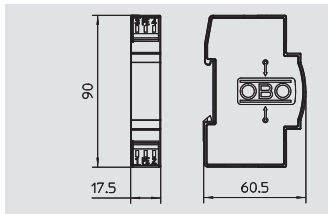

## Medium and fine protection for two-core systems 12 V

Type	Max. continuous operating voltage Vc/AC V	Max. continuous operating voltage Vc/DC V	Number of poles	Connection system	Pack. pcs	Weight kg/100 pcs.	Item No.
<b>FLD 2-12</b>	9	13	2	Terminal	1	5.100	<b>5098 80 8</b>

/pc.

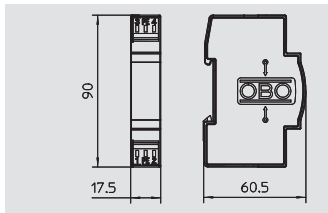

## Medium and fine protection for two-core systems 24 V

Type	Max. continuous operating voltage Vc/AC V	Max. continuous operating voltage Vc/DC V	Number of poles	Connection system	Pack. pcs	Weight kg/100 pcs.	Item No.
<b>FLD 2-24</b>	28	19	2	Terminal	1	5.100	<b>5098 81 6</b>

/pc.

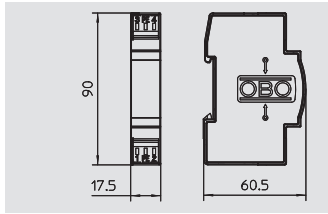

## Medium and fine protection for two-core systems 48 V

Type	Max. continuous operating voltage Vc/AC V	Max. continuous operating voltage Vc/DC V	Number of poles	Connection system	Pack. pcs	Weight kg/100 pcs.	Item No.
<b>FLD 2-48</b>	37	53	2	Terminal	1	5.100	<b>5098 82 4</b>

/pc.

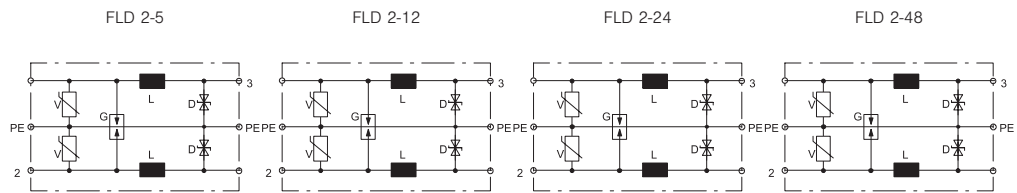

Maximum continuous operating voltage Vc/AC	V	5	9	28	37
Maximum continuous operating voltage Vc/DC	V	8	13	19	53
Lightning protection Zone LPZ		0-3	0-3	0-3	0-3
Number of poles		2	2	2	2
Rated current	I <sub>L</sub> A	1	1	1	1
Series inductance per path	μH	120 ± 10 %	120 ± 10 %	120 ± 10 %	120 ± 10 %
Impulse durability line-line		C1: 1 kV / 0.5 kA	C1: 1 kV / 0.5 kA	C1: 1 kV / 0.5 kA	C1: 5 kV / 0.25 kA
Impulse durability line-earth		C1: 1 kV / 0.5 kA	C1: 1 kV / 0.5 kA	C1: 1 kV / 0.5 kA	C1: 5 kV / 0.25 kA
Total impulse durability	I <sub>total</sub> kA	C2: 2kV / 1 kA	C2: 2kV / 1 kA	C2: 2kV / 1 kA	C2: 1kV / 0.5 kA
Voltage protection level line-line	V	30	60	120	240
Voltage protection level line-earth	V	15	30	60	130
Shielding connection available		No	No	No	No
Shield connection		-	-	-	-
Temperature range	θ °C	-40 - +80	-40 - +80	-40 - +80	-40 - +80
Division unit TE (17.5 mm)		1	1	1	1
Connection cross-section, flexible	mm <sup>2</sup>	0,14 - 2,5	0,14 - 2,5	0,14 - 2,5	0,14 - 2,5
Connection cross-section, multi-wire	mm <sup>2</sup>	0,14 - 2,5	0,14 - 2,5	0,14 - 2,5	0,14 - 2,5
Connection cross-section, rigid	mm <sup>2</sup>	0,14 - 2,5	0,14 - 2,5	0,14 - 2,5	0,14 - 2,5
Testing standard		IEC 61643-21	IEC 61643-21	IEC 61643-21	IEC 61643-21
<b>Item No.</b>		<b>5098 86 7</b>	<b>5098 80 8</b>	<b>5098 81 6</b>	<b>5098 82 4</b>

Always indicate the item number when ordering.

# MCR protection for two-core systems



Surge protection for use in measurement and control technology

- Medium and fine protection
- Standard design for single core systems
- Two-stage protection circuit
- With installation-friendly, screwless connection terminals
- In space-saving 17.5 mm grid
- With inductive decoupling in the longitudinal branch

Application: Universal use on any 35 mm hat profile rail in every commercially available distributor housing.



## Medium and fine protection for two-core systems 110 V

Type	Max. continuous operating voltage Vc/AC V	Max. continuous operating voltage Vc/DC V	Number of poles	Connection system	Pack. pcs	Weight kg/100 pcs.	Item No.
<b>FLD 2-110</b>	86	122	2	Terminal	1	5.100	<b>5098 85 9</b>

/pc.

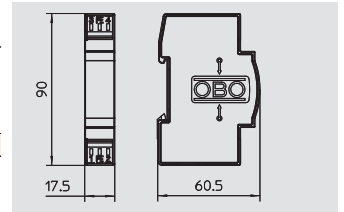

Surge protection device for data and information technology



FLD 2-110

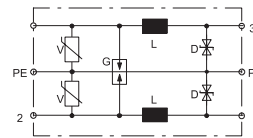

Maximum continuous operating voltage Vc/AC	V	86
Maximum continuous operating voltage Vc/DC	V	122
Lightning protection Zone LPZ		0→3
Number of poles		2
Rated current I <sub>L</sub>	A	1
Series induction per path	μH	120 ± 10 %
Impulse durability line-line		C1: 5 kV / 2.5 kA
Impulse durability line-earth		C1: 5 kV / 2.5 kA
Total impulse durability I <sub>Total</sub>	kA	C2: 10 kV / 5 kA
Voltage protection level line-line	V	500
Voltage protection level line-earth	V	300
Shielding connection available		No
Shield connection		-
Temperature range θ	°C	-40 - +80
Division unit TE (17.5 mm)		1
Connection cross-section, flexible	mm <sup>2</sup>	0,14 - 2,5
Connection cross-section, multi-wire	mm <sup>2</sup>	0,14 - 2,5
Connection cross-section, rigid	mm <sup>2</sup>	0,14 - 2,5
Testing standard		IEC 61643-21
<b>Item No.</b>		<b>5098 85 9</b>



## MCR protection for multi-wire systems (testable): the plus of the MDP family

- +Protection device for multi-wire systems (4-pole)
- +Direct shield earthing
- +Easy-mounting, screwless connection terminals
- +Space-saving width of just 8.1 mm
- +Versions with nominal currents up to 10 A
- +High frequency bandwidth up to 100 MHz
- +UL-listed



Besides the high current capacity, the lightning barriers of type MDP offer a narrow installation width of just 8 mm. A separate screen connection permits shield attachment on both sides of the equipotential bonding, thus optimising the shield

effect against capacitive and inductive couplings. Depending on the version, a nominal current of up to 10 A can be applied to the devices, meaning that they are thus ideally suited to use in special applications, such as slip ring

transmitters or heating systems in wind power systems. When installed, all the MDPS can be checked using LifeControl.



# MCR protection for multi-wire systems (testable)

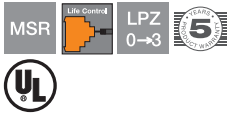

Testable data cable protection devices for multi-wire systems

- Narrow installation width of only 8 mm
- Low protection level for high current load
- Screwless terminals
- Bandwidth-optimised for secure transmission
- Quick mounting on hat rail or wall mounting
- Testable in installed state

Application: Measuring technology, switchgear cabinet construction, etc.



## Series protection device, 2-pole, 5 V version

Type	Max. continuous operating voltage $V_c/AC$ V	Max. continuous operating voltage $V_c/DC$ V	Number of poles	Connection system	Pack. pcs	Weight kg/100 pcs.	Item No.
<b>MDP-2 D-5-T</b>	7	10	2	Terminal	1	6.000	<b>5098 40 4</b>

/pc.

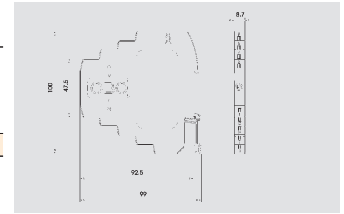

## Series protection device, 3-pole, 5 V version

Type	Max. continuous operating voltage $V_c/AC$ V	Max. continuous operating voltage $V_c/DC$ V	Number of poles	Connection system	Pack. pcs	Weight kg/100 pcs.	Item No.
<b>MDP-3 D-5-T</b>	7	10	3	Terminal	1	6.000	<b>5098 40 7</b>

/pc.

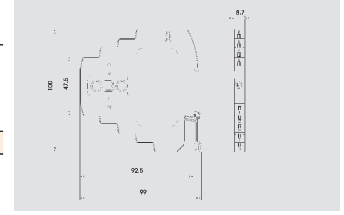

## Series protection device, 4-pole, 5 V version

Type	Max. continuous operating voltage $V_c/AC$ V	Max. continuous operating voltage $V_c/DC$ V	Number of poles	Connection system	Pack. pcs	Weight kg/100 pcs.	Item No.
<b>MDP-4 D-5-T</b>	7	10	4	Terminal	1	6.000	<b>5098 41 1</b>

/pc.

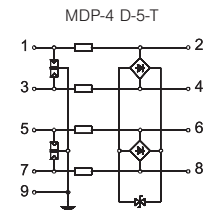
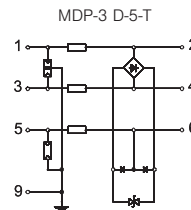
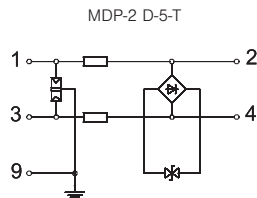
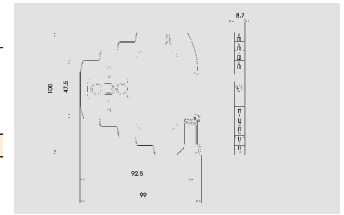

Maximum continuous operating voltage $V_c/AC$	V	7	7	7
Maximum continuous operating voltage $V_c/DC$	V	10	10	10
Lightning protection Zone LPZ		0→3	0→3	0→3
Number of poles		2	3	4
Rated current	$I_L$	A	0.58	0.58
Serial impedance per path	$\Omega$		$2,35 \pm 5\%$	$2,35 \pm 5\%$
Impulse durability line-line			C1: 0.5 kV / 0.25 kA	C1: 0.5 kV / 0.25 kA
Impulse durability line-earth			C2: 5 kV / 2,5 kA	C2: 5 kV / 2,5 kA
Total impulse durability (10/350)			D1: 1	D1: 2kA
Total impulse durability (8/20)			5	7,5
Voltage protection level line-line			35	35
Voltage protection level line-earth			800	800
Shielding connection available			Yes	Yes
Shield connection			Direct	Direct
Temperature range	$\vartheta$	$^{\circ}C$	-40 - +80	-40 - +80
Connection cross-section, flexible		$mm^2$	2.5	2.5
Connection cross-section, multi-wire		$mm^2$	1.5	1.5
Connection cross-section, rigid		$mm^2$	2.5	2.5
Testing standard			IEC 61643-21	IEC 61643-21
<b>Item No.</b>			<b>5098 40 4</b>	<b>5098 40 7</b>
				<b>5098 41 1</b>



# MCR protection for multi-wire systems (testable)

Testable data cable protection devices for multi-wire systems

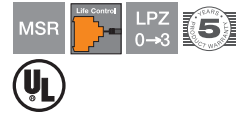

- Narrow installation width of only 8 mm
- Low protection level for high current load
- Screwless terminals
- Bandwidth-optimised for secure transmission
- Quick mounting on hat rail or wall mounting
- Testable in installed state

Application: Measuring technology, switchgear cabinet construction, etc.

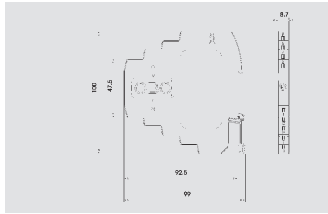

## Series protection device, 2-pole, 24 V version

Type	Max. continuous operating voltage Vc/AC V	Max. continuous operating voltage Vc/DC V	Number of poles	Connection system	Pack. pcs	Weight kg/100 pcs.	Item No.
<b>MDP-2 D-24-T</b>	20	28	2	Terminal	1	6.000	<b>5098 42 2</b>

/pc.

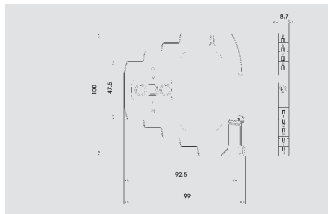

## Series protection device, 3-pole, 24 V version

Type	Max. continuous operating voltage Vc/AC V	Max. continuous operating voltage Vc/DC V	Number of poles	Connection system	Pack. pcs	Weight kg/100 pcs.	Item No.
<b>MDP-3 D-24-T</b>	20	28	3	Terminal	1	6.000	<b>5098 42 7</b>

/pc.

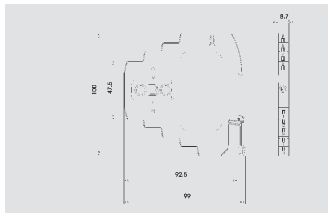

## Series protection device, 4-pole, 24 V version

Type	Max. continuous operating voltage Vc/AC V	Max. continuous operating voltage Vc/DC V	Number of poles	Connection system	Pack. pcs	Weight kg/100 pcs.	Item No.
<b>MDP-4 D-24-T</b>	20	28	4	Terminal	1	5.800	<b>5098 43 1</b>

/pc.

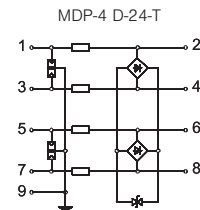
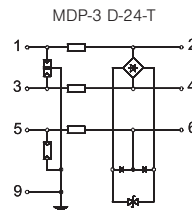
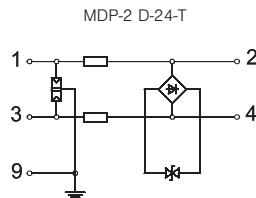

Maximum continuous operating voltage Vc/AC	V	20	20	20
Maximum continuous operating voltage Vc/DC	V	28	28	28
Lightning protection Zone LPZ		0-3	0-3	0-3
Number of poles		2	3	4
Rated current	I <sub>n</sub> A	0.58	0.58	0.58
Serial impedance per path	Ω	2,35 ± 5 %	2,35 ± 5 %	2,35 ± 5 %
Impulse durability line-line		C1: 0.5 kV / 0.25 kA	C1: 0.5 kV / 0.25 kA	C1: 0.5 kV / 0.25 kA
Impulse durability line-earth		C2: 5 kV / 2,5 kA	C2: 5 kV / 2,5 kA	C2: 5 kV / 2,5 kA
Total Impulse durability (10/350)	kA	D1: 1	D1: 1,5	D1: 2
Total Impulse durability (8/20)	kA	5	7,5	10 kA
Voltage protection level line-line	V	55	95	55
Voltage protection level line-earth	V	800	800	800
Shielding connection available		Yes	Yes	Yes
Shield connection		Direct	Direct	Direct
Temperature range	θ °C	-40 - +80	-40 - +80	-40 - +80
Connection cross-section, flexible	mm <sup>2</sup>	2.5	2.5	2.5
Connection cross-section, multi-wire	mm <sup>2</sup>	1.5	1.5	1.5
Connection cross-section, rigid	mm <sup>2</sup>	2.5	2.5	2.5
Testing standard		IEC 61643-21	IEC 61643-21	IEC 61643-21
<b>Item No.</b>		<b>5098 42 2</b>	<b>5098 42 7</b>	<b>5098 43 1</b>



# MCR protection for multi-wire systems (testable)



Testable data cable protection devices for multi-wire systems

- Narrow installation width of only 8 mm
- Low protection level for high current load
- Screwless terminals
- Bandwidth-optimised for secure transmission
- Quick mounting on hat rail or wall mounting
- Testable in installed state

Application: Measuring technology, switchgear cabinet construction, etc.



## Series protection device, 2-pole, 48 V version

Type	Max. continuous operating voltage Vc/AC V	Max. continuous operating voltage Vc/DC V	Number of poles	Connection system	Pack. pcs	Weight kg/100 pcs.	Item No.
<b>MDP-2 D-48-T</b>	41	58	2	Terminal	1	6.000	<b>5098 44 2</b>

/pc.

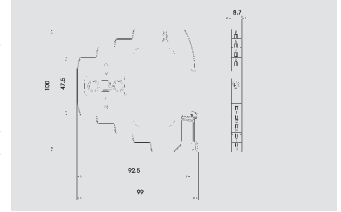

## Series protection device, 3-pole, 48 V version

Type	Max. continuous operating voltage Vc/AC V	Max. continuous operating voltage Vc/DC V	Number of poles	Connection system	Pack. pcs	Weight kg/100 pcs.	Item No.
<b>MDP-3 D-48-T</b>	41	58	3	Terminal	1	6.000	<b>5098 44 6</b>

/pc.

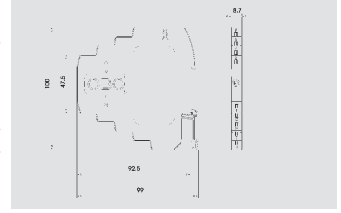

## Series protection device, 4-pole, 48 V version

Type	Max. continuous operating voltage Vc/AC V	Max. continuous operating voltage Vc/DC V	Number of poles	Connection system	Pack. pcs	Weight kg/100 pcs.	Item No.
<b>MDP-4 D-48-T</b>	41	58	4	Terminal	1	5.800	<b>5098 45 0</b>

/pc.

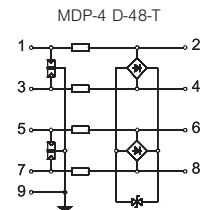
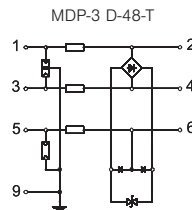
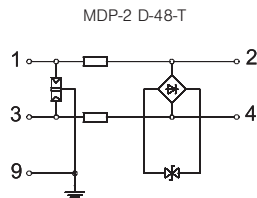
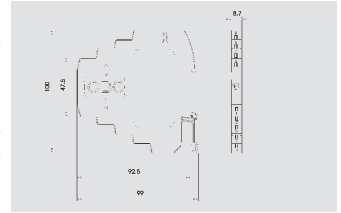

Maximum continuous operating voltage Vc/AC	V	41	41	41
Maximum continuous operating voltage Vc/DC	V	58	58	58
Lightning protection Zone LPZ		0→3	0→3	0→3
Number of poles		2	3	4
Rated current I <sub>L</sub>	A	0.58	0.58	0.58
Serial impedance per path	Ω	2,35 ± 5 %	2,35 ± 5 %	2,35 ± 5 %
Impulse durability line-line		C1: 0.5 kV / 0.25 kA	C1: 0.5 kV / 0.25 kA	C1: 0.5 kV / 0.25 kA
Impulse durability line-earth		C2: 5 kV / 2,5 kA	C2: 5 kV / 2,5 kA	C2: 5 kV / 2,5 kA
Total impulse durability (10/350)		D1: 1	D1: 1,5	D1: 2
Total impulse durability (8/20)		5	7,5	10
Voltage protection level line-line	V	95	95	95
Voltage protection level line-earth	V	800	800	800
Shielding connection available		Yes	Yes	Yes
Shield connection		Direct	Direct	Direct
Temperature range θ	°C	-40 - +80	-40 - +80	-40 - +80
Connection cross-section, flexible	mm <sup>2</sup>	2.5	2.5	2.5
Connection cross-section, multi-wire	mm <sup>2</sup>	1.5	1.5	1.5
Connection cross-section, rigid	mm <sup>2</sup>	2.5	2.5	2.5
Testing standard		IEC 61643-21	IEC 61643-21	IEC 61643-21
<b>Item No.</b>		<b>5098 44 2</b>	<b>5098 44 6</b>	<b>5098 45 0</b>



# MCR protection for multi-wire systems (testable) to 10 A

Testable data cable protection devices for multi-wire systems

- Narrow installation width of only 8 mm
- Low protection level for high current load
- Screwless terminals
- Bandwidth-optimised for secure transmission
- Quick mounting on hat rail or wall mounting
- Testable in installed state

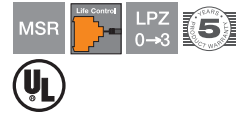

Application: Measuring technology, switchgear cabinet construction, etc.

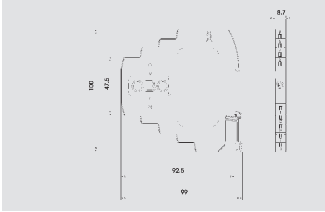

## Series protection device, 4-pole, 5 V version

Type	Max. continuous operating voltage Vc/AC V	Max. continuous operating voltage Vc/DC V	Number of poles	Connection system	Pack. pcs	Weight kg/100 pcs.	Item No.
<b>MDP-4 D-5-T-10</b>	7	10	4	Terminal	1	7.200	<b>5098 41 3</b>

/pc.

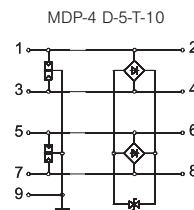

Maximum continuous operating voltage Vc/AC	V	7
Maximum continuous operating voltage Vc/DC	V	10
Lightning protection Zone LPZ		0-3
Number of poles		4
Rated current	$I_L$ A	10
Serial impedance per path	$\Omega$	-
Impulse durability line-line		C1: 0.5 kV / 0.25 kA
Total Impulse durability (10/350)	kA	D1: 2
Total Impulse durability (8/20)	kA	10
Voltage protection level line-line	V	45
Voltage protection level line-earth	V	800
Shielding connection available		Yes
Shield connection		Direct
Temperature range	$\theta$ °C	-40 - +80
Connection cross-section, flexible	mm <sup>2</sup>	2.5
Connection cross-section, multi-wire	mm <sup>2</sup>	1.5
Connection cross-section, rigid	mm <sup>2</sup>	2.5
Testing standard		IEC 61643-21
<b>Item No.</b>		<b>5098 41 3</b>



# MCR protection for multi-wire systems (testable) to 10 A

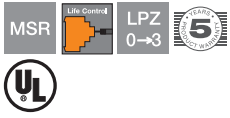

Testable data cable protection devices for multi-wire systems

- Narrow installation width of only 8 mm
- Low protection level for high current load
- Screwless terminals
- Bandwidth-optimised for secure transmission
- Quick mounting on hat rail or wall mounting
- Testable in installed state

Application: Measuring technology, switchgear cabinet construction, etc.



## Series protection device, 2-pole, 12 V version

Type	Max. continuous operating voltage Vc/AC V	Max. continuous operating voltage Vc/DC V	Number of poles	Connection system	Pack. pcs	Weight kg/100 pcs.	Item No.
<b>MDP-2 D-12-T-10</b>	10.5	15	2	Terminal	1	6.000	<b>5098 41 5</b>

/pc.

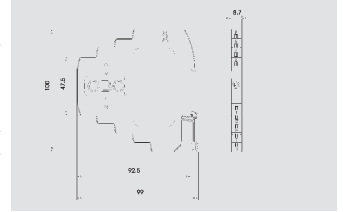

## Series protection device, 4-pole, 12 V version

Type	Max. continuous operating voltage Vc/AC V	Max. continuous operating voltage Vc/DC V	Number of poles	Connection system	Pack. pcs	Weight kg/100 pcs.	Item No.
<b>MDP-4 D-12-T-10</b>	10.5	15	4	Terminal	1	6.000	<b>5098 41 9</b>

/pc.

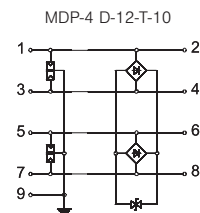
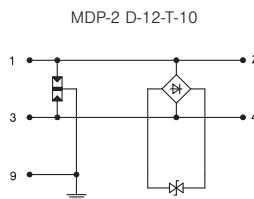
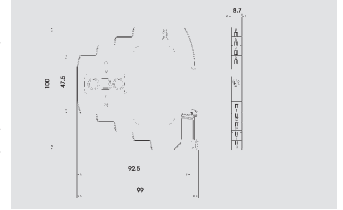

Maximum continuous operating voltage Vc/AC	V	10.5	10.5
Maximum continuous operating voltage Vc/DC	V	15	15
Lightning protection Zone LPZ		0-3	0-3
Number of poles		2	4
Rated current I <sub>L</sub>	A	10	10
Serial impedance per path	Ω	-	-
Impulse durability line-line		C1: 0.5 kV / 0.25 kA	
Total impulse durability (10/350)	kA	D1: 1	D1: 2
Total impulse durability (8/20)	kA	5	10
Voltage protection level line-line	V	55	55
Voltage protection level line-earth	V	800	800
Shielding connection available		Yes	Yes
Shield connection		Direct	Direct
Temperature range θ	°C	-40 - +80	-40 - +80
Connection cross-section, flexible	mm <sup>2</sup>	2.5	2.5
Connection cross-section, multi-wire	mm <sup>2</sup>	1.5	1.5
Connection cross-section, rigid	mm <sup>2</sup>	2.5	2.5
Testing standard		IEC 61643-21	IEC 61643-21
<b>Item No.</b>		<b>5098 41 5</b>	<b>5098 41 9</b>



# MCR protection for multi-wire systems (testable) to 10 A

Testable data cable protection devices for multi-wire systems

- Narrow installation width of only 8 mm
- Low protection level for high current load
- Screwless terminals
- Bandwidth-optimised for secure transmission
- Quick mounting on hat rail or wall mounting
- Testable in installed state

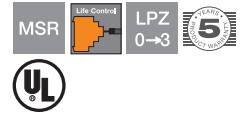

Application: Measuring technology, switchgear cabinet construction, etc.

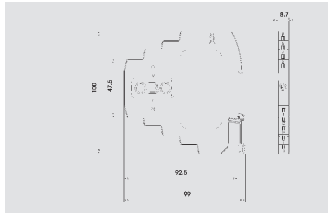

## Series protection device, 2-pole, 24 V version

Type	Max. continuous operating voltage Vc/AC V	Max. continuous operating voltage Vc/DC V	Number of poles	Connection system	Pack. pcs	Weight kg/100 pcs.	Item No.
<b>MDP-2 D-24-T-10</b>	20	28	2	Terminal	1	6.000	<b>5098 42 5</b>

/pc.

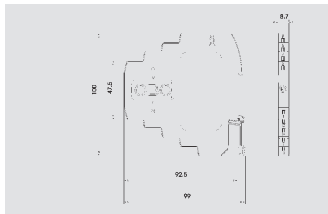

## Series protection device, 4-pole, 24 V version

Type	Max. continuous operating voltage Vc/AC V	Max. continuous operating voltage Vc/DC V	Number of poles	Connection system	Pack. pcs	Weight kg/100 pcs.	Item No.
<b>MDP-4 D-24-T-10</b>	20	28	4	Terminal	1	7.200	<b>5098 43 3</b>

/pc.



MDP-2 D-24-T-10

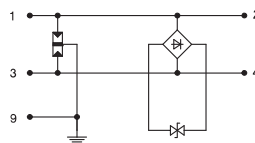

MDP-4 D-24-T-10

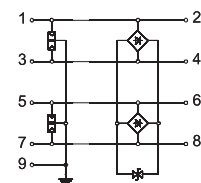

Maximum continuous operating voltage Vc/AC	V	20	20
Maximum continuous operating voltage Vc/DC	V	28	28
Lightning protection Zone LPZ		0→3	0→3
Number of poles		2	4
Rated current I <sub>L</sub>	A	10	10
Serial impedance per path	Ω	-	-
Impulse durability line-line		C1: 0.5 kV / 0.25 kA	C1: 0.5 kV / 0.25 kA
Total Impulse durability (10/350)	kA	D1: 1	D1: 2
Total Impulse durability (8/20)	kA	5	10
Voltage protection level line-line	V	70	70
Voltage protection level line-earth	V	800	800
Shielding connection available		Yes	Yes
Shield connection		Direct	Direct
Temperature range θ	°C	-40 - +80	-40 - +80
Connection cross-section, flexible	mm <sup>2</sup>	2.5	2.5
Connection cross-section, multi-wire	mm <sup>2</sup>	1.5	1.5
Connection cross-section, rigid	mm <sup>2</sup>	2.5	2.5
Testing standard		IEC 61643-21	IEC 61643-21
<b>Item No.</b>		<b>5098 42 5</b>	<b>5098 43 3</b>



# Accessories for MCR protection



## Accessories for series terminal

Type	Pack.	Weight	Item No.
	pcs	kg/100 pcs.	
<b>VB-MDP 10-MD</b>	1	2.300	<b>5098 47 0</b>

**Cu** Copper

Connecting bridge for 8 mm lightning barriers

- Length of bridge can be adjusted
- Material: Copper
- Allows quick equipotential bonding

Application: Parallel switching of the MDP lightning barriers

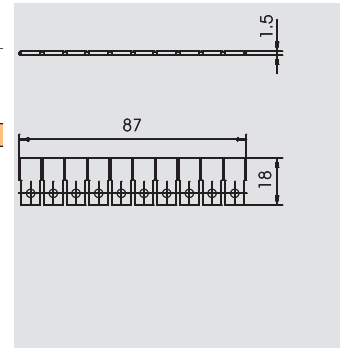

## Replacement connector for VF remote signalling

Type	Version	Pack.	Weight	Item No.
		pcs	kg/100 pcs.	
<b>VF-FS</b>	3-pole	25	0.320	<b>5098 47 5</b>

Replacement telephony connector, 3-pin version, for VF variant

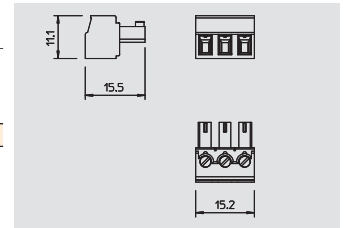



## MCR protection for explosive areas: the plus of the Petrol Field Protector family

- +For explosive areas
- +Two or three-pole protection of various sensors
- +Metric or NPT thread
- +Robust VA housing
- +High arresting capacity



In the Petrol Field Protector for data cable protection devices, OBO Bettermann can offer a surge protection device for sensors in potentially explosive areas. The Petrol Field Protector permits two or three-pole protection for all kinds of sensors. The protection device can be fastened directly on the sensor and wired in using the appropriate metric or NPT thread.

The robust VA housing means that aggressive atmospheres are no problem. The intrinsic safety of the Petrol Field Protector was independently tested and certified. The Petrol Field Protector is your partner for safety-relevant applications, in which effective surge protection must be guaranteed.



# MCR protection for explosive areas



Data cable protection devices for intrinsically-safe measuring circuits and bus systems

- Different connection systems available (metric/NPT)
- Low protection level at high current load
- Easy mounting on field devices
- Negligible internal capacitance and inductance
- Easy retrofitting

Application: Flow sensors, temperature sensors

## MCR protection for explosive areas, 2-pole, 24 V



Type	U max DC V	U max AC V	Version	Pack. pcs	Weight kg/100 pcs.	Item No.
<b>FDB-2 24-M</b>	32	22	2-pole; metric	1	18.500	<b>5098 38 0</b>

/pc.

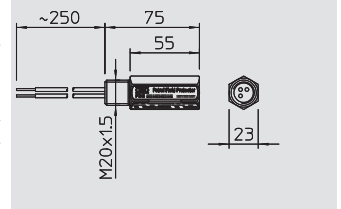

## MCR protection for explosive areas, 3-pole, 24 V



Type	U max DC V	U max AC V	Version	Pack. pcs	Weight kg/100 pcs.	Item No.
<b>FDB-3 24-M</b>	32	22	3-pole; metric	1	19.000	<b>5098 38 2</b>

/pc.

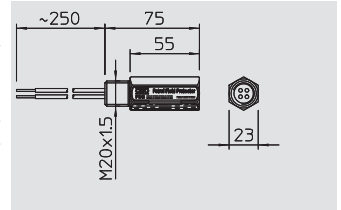

## MCR protection for explosive areas, 2-pole, 24 V



Type	U max DC V	U max AC V	Version	Pack. pcs	Weight kg/100 pcs.	Item No.
<b>FDB-2 24-N</b>	32	22	2-pole; NPT	1	19.000	<b>5098 39 0</b>

/pc.

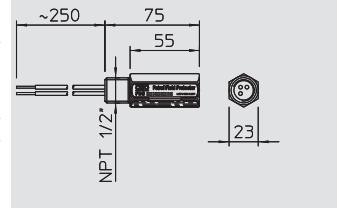

## MCR protection for explosive areas, 3-pole, 24 V



Type	U max DC V	U max AC V	Version	Pack. pcs	Weight kg/100 pcs.	Item No.
<b>FDB-3 24-N</b>	32	22	3-pole; NPT	1	19.500	<b>5098 39 2</b>

/pc.

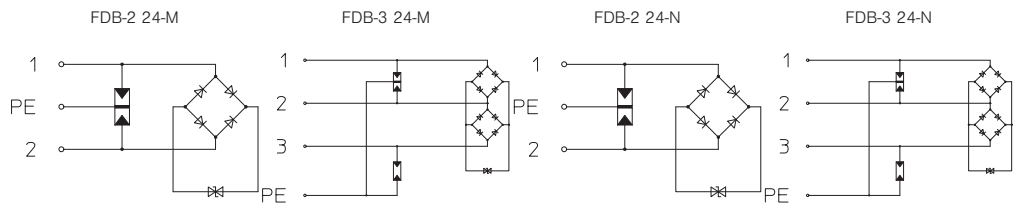
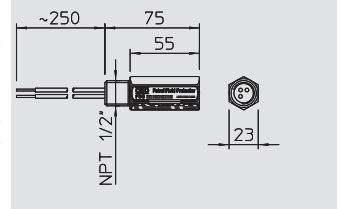

U max AC	U <sub>c</sub> AC	V	22	22	22	22
U max DC	U <sub>c</sub> DC	V	32	32	32	32
Total impulse durability into C2 (8/20)		kA	10	10	10	10
Impulse durability int C2 (wire-wire)		kA	0.25	0.25	0.25	0.25
Voltage protection level line-earth		V	< 850	< 850	< 850	< 850
Voltage protection level line-line		V	< 80	< 80	< 80	< 80
Temperature range	θ	°C	-20 - +70	-20 - +70	-20 - +70	-20 - +70
Signalling on device			None	None	None	None
Capacity (wire-wire)			< 27 pF	< 27 pF	< 27 pF	< 27 pF
Capacity (wire-earth)			< 27 pF	< 27 pF	< 27 pF	< 27 pF
Mounting of input / output			M20 x 1.5 external thread	M20 x 1.5 external thread	1/2" NPT	1/2" NPT
Mounting of field / device side:			Connection cable 1.5 mm <sup>2</sup> Length ~ 250 mm	Connection cable 1.5 mm <sup>2</sup> Length ~ 250 mm	Connection cable 1.5 mm <sup>2</sup> Length ~ 250 mm	Connection cable 1.5 mm <sup>2</sup> Length ~ 250 mm
Earthing via:			Connection cable	Connection cable	Connection cable	Connection cable
Housing material			V2A	V2A	V2A	V2A
Approval			ATEX	ATEX	ATEX	ATEX
<b>Item No.</b>			<b>5098 38 0</b>	<b>5098 38 2</b>	<b>5098 39 0</b>	<b>5098 39 2</b>



## MSR protection for Ex areas: the plus of the MDP Ex family

- +Protection device for multi-wire systems (4-pole)
- +Direct shield earthing
- +Easy-mounting, screwless connection option
- +Space-saving width of just 8.1 mm
- +Ex-tested for intrinsically-safe measuring circuits
- +High frequency bandwidth up to 100 MHz



Surge protection in potentially explosive areas is an important topic. Here, it is important to protect costly measuring technology against the influence of surge voltages through atmospheric discharge. OBO lightning barriers are tested for intrinsic safety (ia) and

are independently certified. With a high arresting capacity of 10 kA, they offer optimum protection for four-pole measurement and control applications. Different voltage variants offer a wide range of applications.



# MCR protection for explosive areas



MDP.../D...-EX : Lightning barrier for intrinsically-safe measuring circuits

- Protection device for multi-wire systems
- Direct shield earthing
- With easy-to-mount, screwless connection terminals
- Space-saving width of just 8.1 mm
- Ex-tested for intrinsically-safe measuring circuits
- High bandwidth up to 100 MHz

Application: universal use on 35 mm hat profile rail in any standard distribution housing.



## Series protection device, 4-pole, 5 V version, Ex-tested

Type	Max. continuous operating voltage Vc/AC V	Max. continuous operating voltage Vc/DC V	Number of poles	Pack. pcs	Weight kg/100 pcs.	Item No.
<b>MDP-4 D-5-EX</b>	7	10	4	1	5.800	<b>5098 41 2</b>

/pc.

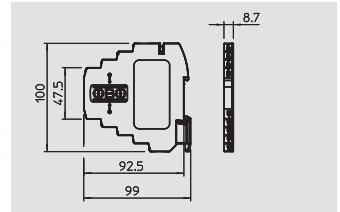

## Series protection device, 4-pole, 24 V version, Ex-tested

Type	Max. continuous operating voltage Vc/AC V	Max. continuous operating voltage Vc/DC V	Number of poles	Pack. pcs	Weight kg/100 pcs.	Item No.
<b>MDP-4 D-24-EX</b>	20	28	4	1	5.800	<b>5098 43 2</b>

/pc.

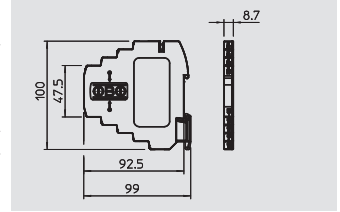

## Series protection device, 4-pole, 48 V version, Ex-tested

Type	Max. continuous operating voltage Vc/AC V	Max. continuous operating voltage Vc/DC V	Number of poles	Pack. pcs	Weight kg/100 pcs.	Item No.
<b>MDP-4 D-48-EX</b>	41	58	4	1	5.800	<b>5098 45 2</b>

/pc.

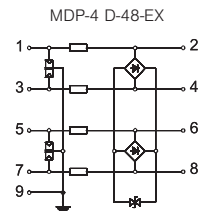
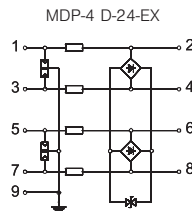
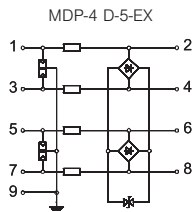
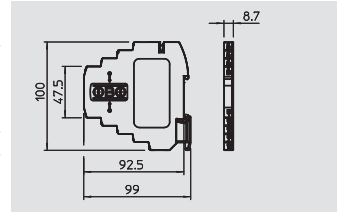



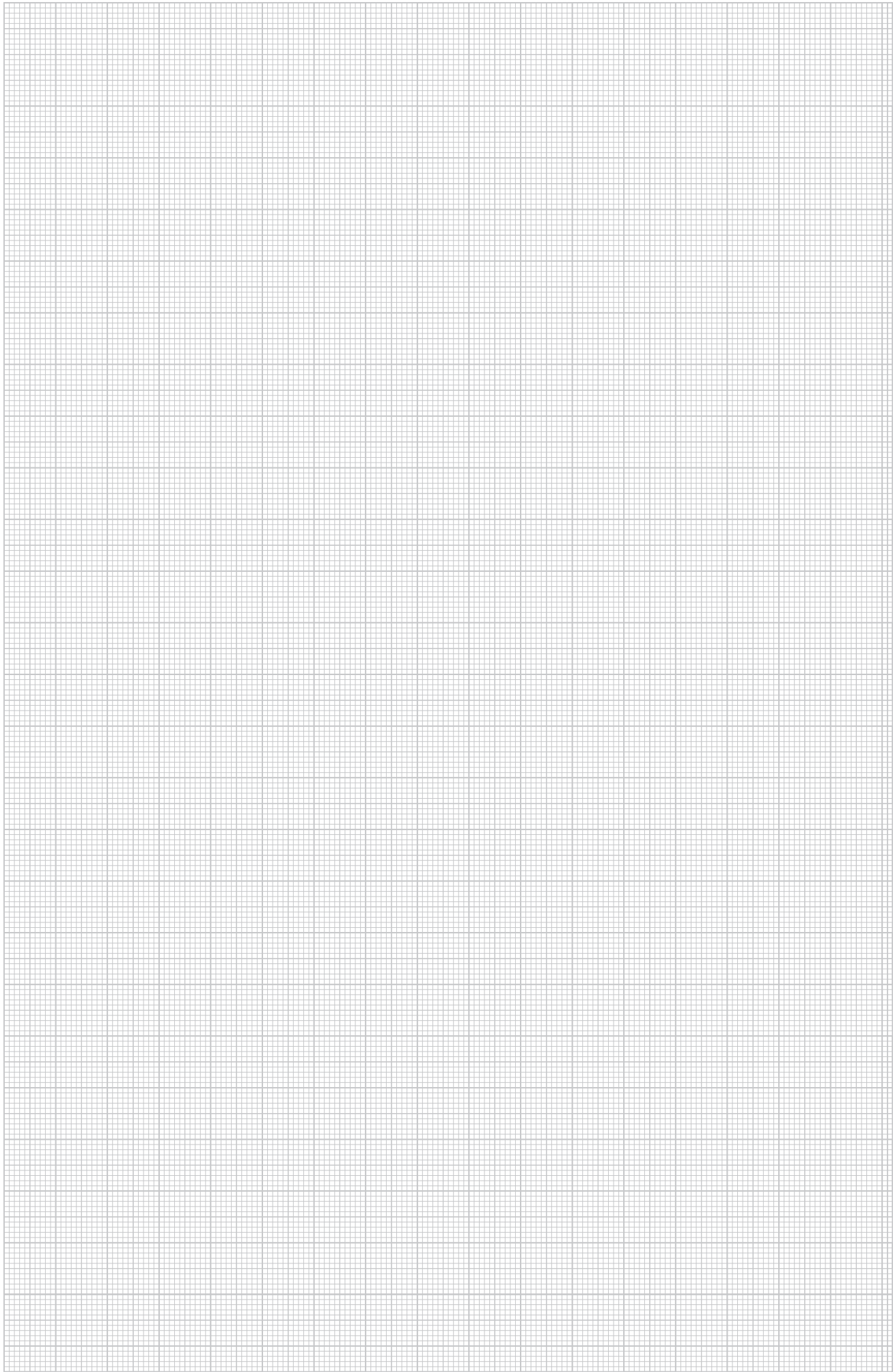

Maximum continuous operating voltage Vc/AC	V	7	20	41
Maximum continuous operating voltage Vc/DC	V	10	28	58
Lightning protection Zone LPZ		1→3	1→3	1→3
Number of poles		4	4	4
Rated current I <sub>L</sub>	A	0.58	0.58	0.58
Serial impedance per path	Ω	2,35 ± 5 %	2,35 ± 5 %	2,35 ± 5 %
Impulse durability line-line		C1: 0.5 kV / 0.25 kA	C1: 0.5 kV / 0.25 kA	C1: 0.5 kV / 0.25 kA
Impulse durability line-earth		C2: 5 kV / 2,5 kA	C2: 5 kV / 2,5 kA	C2: 5 kV / 2,5 kA
Total Impulse durability (10/350)	kA	D1: 2kA	D1: 2	D1: 2
Total Impulse durability (8/20)	kA	10 kA	10 kA	10
Voltage protection level line-line	V	35 V	55	95
Voltage protection level line-earth	V	800 V	800	800
Shielding connection available		Yes	Yes	Yes
Shield connection		Direct	Direct	Direct
Temperature range θ	°C	-40 - +80	-40 - +80	-40 - +80
Connection cross-section, flexible	mm <sup>2</sup>	2.5	2.5	2.5
Connection cross-section, multi-wire	mm <sup>2</sup>	1.5	1.5	1.5
Connection cross-section, rigid	mm <sup>2</sup>	2.5	2.5	2.5
Ex approval		Ex II 2(1) G Ex ia IIC T4	Ex II 2(1) G Ex ia IIC T4	Ex II 2(1) G Ex ia IIC T4
Testing standard		IEC 61643-21	IEC 61643-21	IEC 61643-21
<b>Item No.</b>		<b>5098 41 2</b>	<b>5098 43 2</b>	<b>5098 45 2</b>







## Surge protection, protection and spark gaps

	Spark gap	Explosion-protected	288
		Connection lugs	288
		Closed	288
	Protective spark gap	-	289
	Spark gap/surge voltage protection	To couple earthing systems	289



# Protection and spark gaps



## Explosion-proof, closed spark gap

Type	Connection cable length m	Contact voltage kV	Impulse discharge current (10/350) kA	Nominal discharge current (8/20) kA	Protection level kV	Temperature range °C	Pack. pcs	Weight kg/100 pcs.	Item No.
<b>480 180</b>	0.18	1	100	100	< 3,0	-20+50	1	48.000	<b>5240 03 4</b>
<b>480 250</b>	0.25	1	100	100	< 3,0	-20+50	1	50.000	<b>5240 07 7</b>
<b>480 350</b>	0.35	1	100	100	< 3,0	-20+50	1	53.000	<b>5240 06 9</b>



/pc.

- Ex-tested to ATEX directive 94/9/EG
- Designation: Ex II 2G EEx d IIC T6
- Incl. connector cable 25 mm<sup>2</sup> Cu, highly-flexible, with cable lug, screw (M 10), nut and lock washer
- Pulsed current 100 kA (10/350µs)
- BET tested

Application: Indirect by-passing of insulating flanges and insulating glands.

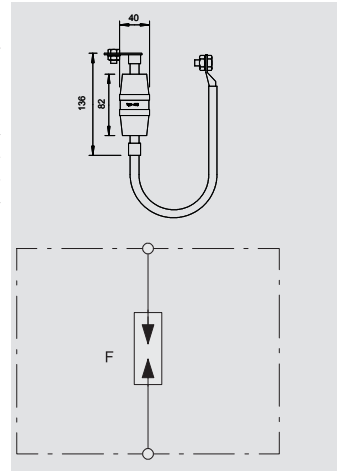

## Connection strap for Parex spark gap

Type	Bore hole Ø mm	Version	Pack. pcs	Weight kg/100 pcs.	Item No.
<b>484 M12</b>	13	For M10 bolt	10	8.100	<b>5240 22 0</b>
<b>484 M16</b>	17	For M16 bolt	10	7.700	<b>5240 23 9</b>
<b>484 M20</b>	21	For M20 bolt	10	7.300	<b>5240 24 7</b>
<b>484 M24</b>	25	For M24 bolt	10	6.800	<b>5240 25 5</b>

**St** Steel **F** Hot-dip galvanised

/pc.

Attaching flange for installing OBO Parex spark gap 480 on insulating flanges.

Type	Bore hole Ø mm	Version	Pack. pcs	Weight kg/100 pcs.	Item No.
<b>485 M12</b>	13	For M10 bolt	10	8.100	<b>5240 32 8</b>
<b>485 M10</b>	11	For M16 bolt	10	8.300	<b>5240 30 1</b>
<b>485 M16</b>	17	For M20 bolt	10	7.700	<b>5240 33 6</b>
<b>485 M20</b>	21	For M24 bolt	10	7.300	<b>5240 34 4</b>

**St** Steel **F** Hot-dip galvanised

/pc.

Attaching flange for installing OBO Parex spark gap 480 on insulating flanges.

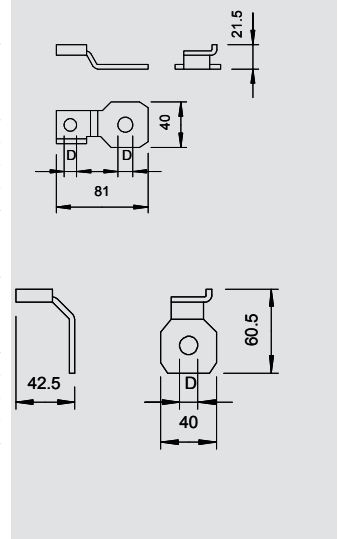

## Closed spark gap with lightning current carrying capability

Type	Impulse discharge current (10/350) kA	Nominal discharge current (8/20) kA	Protection level kV	Contact voltage kV	Temperature range °C	Pack. pcs	Weight kg/100 pcs.	Item No.
<b>481</b>	50	100	< 5	2.5	-20+50	1	26.500	<b>5240 08 5</b>

/pc.

Closed, lightning current carrying spark gap for separation of electrically conductive plant components.

- Connection bolts; Ø 10 mm; stainless steel.
- Pulsed current 50 kA (10/350)
- BET

Tested Application: Installation of electrical isolations for external lighting protection and earthing systems, e.g. two earthing systems on account of mutual influence or corrosion (corrosion current prevention).

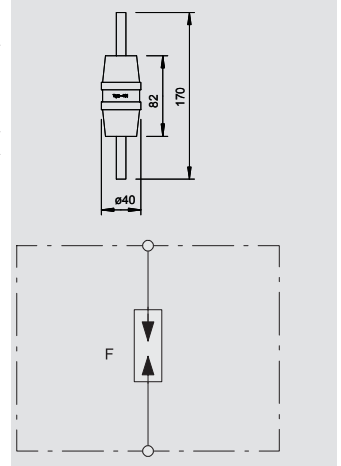



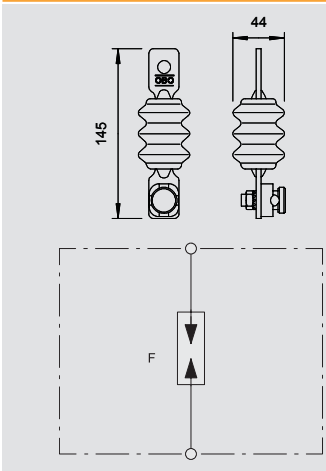

## Protective spark gap



Type	Protection level kV	Contact voltage kV	Pack. pcs	Weight kg/100 pcs.	Item No.
482	< 10 kV	10	1	56.000	5240 05 0

/pc.

Closed spark gap for bridging a proximity point between roof standard of low-voltage system and components of outer lightning protection system

- Protection rating IP 54
- With pre-mounted type 5001 connector for attaching round conductors Rd 8 - 10

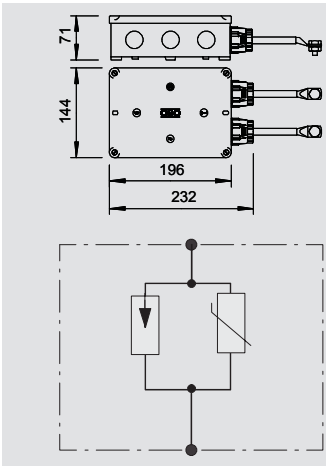

## Spark gap / surge voltage protection for coupling earthing systems



Type	Max. continuous operating voltage V	Impulse discharge current (10/350) kA	Nominal discharge current (8/20) kA	Protection level kV	Degree of protection of enclosure	Pack. pcs	Weight kg/100 pcs.	Item No.
FS-V20	280	100	100	< 1,5	IP 54	1	170.000	5099 80 3

/pc.





The FS-V 20 device is a discharge gap with parallel-connected surge voltage protector. It is used to couple different earthing systems. It is connected directly to the equipotential bonding rail concerned.

Application: Coupling earthing systems in data technology sector (functional and operational earthing)





## Measuring and test systems

	ISOLAB measuring system arrester tester	292
	Testing unit for lightning barriers	292
	Magnetic card PCS	293
	Magnetic card holder PCS-H	293
	Card reader PCS-CS..	293

# Measuring and test systems



## ISOLAB measuring system arrester tester

Type	Country version	Nominal voltage V	Measuring range	Pack. pcs	Weight kg/100 pcs.	Item No.
<b>ISOLAB</b>	D/GB	6	0 V- 999 V	1	165.000	<b>5096 81 2</b>

/pc.

To test the insulation resistance to DIN VDE 0100 Part 610 and the characteristic curve behaviour of the following surge voltage and lightning current arrestors:

- V10-C and V20-C:
 

Uc	Tolerance range
75 V	-> 110 V - 130 V
150 V	-> 215 V - 265 V
280 V	-> 385 V - 475 V
320 V	-> 460 V - 560 V
335 V	-> 460 V - 560 V
385 V	-> 560 V - 680 V
440 V	-> 645 V - 785 V
550 V	-> 820 V - 1,000 V
- V25-B+C and V50-B+C:
 

Uc	Tolerance range
150 V	-> 215 V - 265 V
280 V	-> 385 V - 475 V
320 V	-> 460 V - 560 V
385 V	-> 560 V - 680 V
- Varistor arrestors of other manufacturers can be tested for 1 or 3 mA characteristic curve behaviour
- Battery operation
- Measuring cables contained in the scope of delivery.

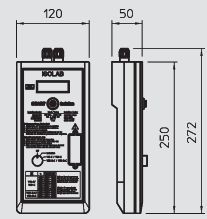

## Testing unit for lightning barriers

Type	Pack. pcs	Weight kg/100 pcs.	Item No.
<b>LFC</b>	1	164.500	<b>5096 78 6</b>

/pc.

OBO Life Control allows function control of the MDP lightning barriers. The lightning barriers can be checked while installed. Life Control will not have any influence on the measuring signal. Life Control possesses an integrated OLED with visual and acoustic defect signalling. A separate LED inside the testing pin is also integrated. Life Control is delivered in a case, complete with a CD and instructions.

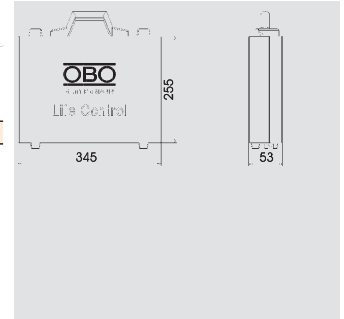

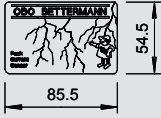

**Magnetic card PCS**



Type	Pack.	Weight	Item No.
	PU	kg/100 PUs	
<b>PCS</b>	1	8.000	<b>5091 43 8</b>



/VPE

Magnetic card for recording pulsed/lightning currents.

- Contents = 10 pieces

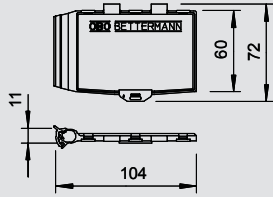

**Magnetic card holder PCS-H**

Type	Pack.	Weight	Item No.
	PU	kg/100 PUs	
<b>PCS-H</b>	1	31.000	<b>5091 52 7</b>



/VPE

Magnetic card holder for mounting PCS cards.

- Sealable holder
- For installing on round conductor Rd 8-10
- Simple holder installation by means of clamp
- 1 PU = 10 pieces



**Magnetic card and holder MK-B**

Type	Pack.	Weight	Item No.
	PU	kg/100 PUs	
<b>MK-B</b>	1	31.000	<b>5091 32 2</b>



/VPE

PCS magnetic card to record pulse/lightning currents including holder

- Holder can be leaded
- For mounting on round conductor Rd 8-10
- Simple holder mounting through clamping
- 1 PU = 10 units

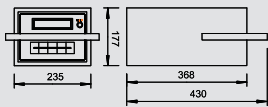

**Card reader PCS-CS...**



Type	Country version	Nominal voltage	Measuring range	Measuring tolerances	Pack.	Weight	Item No.
		V			pcs	kg/100 pcs.	
<b>PCS-CS-D</b>	EN	230	3- 120 kA	< 2 kA (< 2%)	1	750.000	<b>5091 68 3</b>
<b>PCS-CS-GB</b>	GB	230	3- 120 kA	< 2 kA (< 2%)	1	750.000	<b>5091 69 1</b>







/pc.

Magnetic card reader for reading and analysing PCS cards.

- Inc. rechargeable battery for 4 h continuous, no-mains operation
- Large, clear display



## Equipotential bonding systems

	Equipotential bonding rails	For indoor use	296
		For outdoor use	300
		For industrial use	301
	Strip earthing clips		303
	Earthing clips		304



# Equipotential bonding rails for indoor use



## Equipotential bonding rail for indoors, VDE-tested

Type	Colour	Pack.	Weight	Item No.
		pcs	kg/100 pcs.	
<b>1801 VDE</b>	Grey	1	55.000	<b>5015 65 0</b>

**CuZn** Brass /pc.

Equipotential bonding rail for equipotential bonding according to DIN VDE 0100-410 / -540 and lightning protection equipotential bonding according to DIN VDE 0185-305

Connection options:

- 7 single or multi-wire cables 2.5–25 mm<sup>2</sup> or fine-wire cables to 16 mm<sup>2</sup> (max. Ø 7 mm)
- 2 single or multi-wire cables 25–95 mm<sup>2</sup> or fine-wire cables to 70 mm<sup>2</sup> (max. Ø 13.5 mm)
- 1 flat conductor 30 x 3.5 mm
- According to VDE 0618, part 1
- With clamping rail 10 x 10 mm, nickel-plated brass
- With close-contact series terminals made of electrogalvanised steel
- Cover hood and rail stand made of grey polystyrene
- Lightning current carrying capacity 100 kA (10/350)
- Tension clamp with screw lock against self-loosening (e.g. required in industry and in explosion-protected areas)

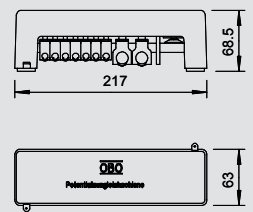

## Round cable terminal to 25 mm<sup>2</sup> for 1801 VDE

Type	Connection option	Pack.	Weight	Item No.
		pcs	kg/100 pcs.	
<b>1801 RK25</b>	2.5–25 mm <sup>2</sup>	10	2.080	<b>5015 75 8</b>

**St** Steel **G** Electrogalvanised /pc.

- For single or multi-wire cables 2.5–25 mm<sup>2</sup>
- For fine-wire cables to 16 mm<sup>2</sup> (max. Ø 7 mm)
- 1 division unit
- Lightning current carrying capacity 100 kA (10/350)
- Electrogalvanised steel
- Tension clamp with screw lock against self-loosening (e.g. required in industry and in explosion-protected areas)

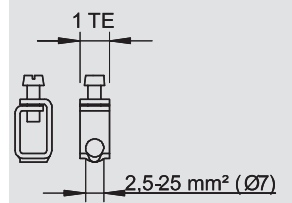

## Round cable terminal from 25 mm<sup>2</sup> for 1801 VDE

Type	Connection option	Pack.	Weight	Item No.
		pcs	kg/100 pcs.	
<b>1801 RK95</b>	25–95 mm <sup>2</sup>	10	4.700	<b>5015 76 6</b>

**St** Steel **G** Electrogalvanised /pc.

- For single or multi-wire cables 25–95 mm<sup>2</sup>
- For fine-wire cables to 70 mm<sup>2</sup> (max. Ø 13.5 mm)
- 2 division units
- Lightning current carrying capacity 100 kA (10/350)
- Electrogalvanised steel
- Tension clamp with screw lock against self-loosening (e.g. required in industry and in explosion-protected areas)

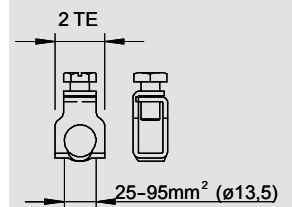

## Flat conductor terminal to FL 30 for 1801 VDE

Type	Connection option	Pack.	Weight	Item No.
		pcs	kg/100 pcs.	
<b>1801 RK30</b>	FL30 x 5	10	18.410	<b>5015 73 1</b>

**St** Steel **G** Electrogalvanised /pc.

- For flat conductors to FL 30 and thickness to 5 mm
- Captive design with plastic safety strap
- 3 division units
- Lightning current carrying capacity 100 kA (10/350)
- Electrogalvanised steel

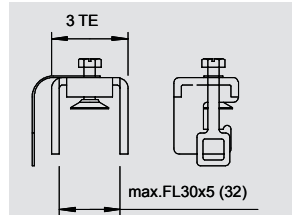

## Flat conductor terminal from FL 30 for 1801 VDE

Type	Connection option	Pack.	Weight	Item No.
		pcs	kg/100 pcs.	
<b>1801 RK40</b>	FL40 x 5	10	7.300	<b>5015 77 4</b>

**St** Steel **G** Electrogalvanised /pc.

- For flat conductors from FL 30
- 2 terminals always required for each flat conductor connection
- Lightning current carrying capacity 100 kA (10/350)
- Electrogalvanised steel

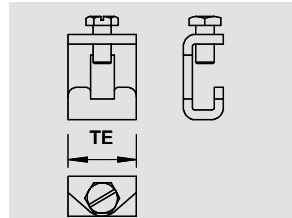



# Equipotential bonding rails for indoor use

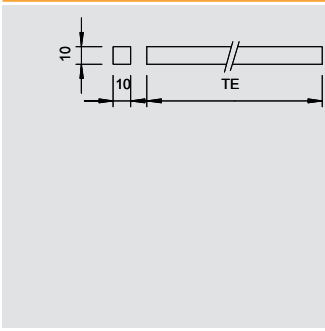

## Contact strip for 1801 VDE

Type	Length	Pack.	Weight	Item No.
	mm	pcs	kg/100 pcs.	
<b>1801 KL1</b>	212	1	18.000	<b>5015 72 3</b>
<b>1801 KL2</b>	430	1	36.000	<b>5015 80 4</b>
<b>1801 KL3</b>	645	1	54.000	<b>5015 81 2</b>

**CuZn** Brass /pc.

- 10 x 10 mm made of nickel-plated brass
- 1801 KL1: 14 subunits
- 1801 KL2: 28 subunits
- 1801 KL3: 42 subunits

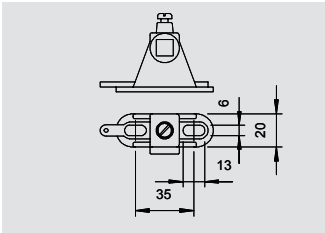

## Rail stands for 1801 VDE

Type	Colour	Pack.	Weight	Item No.
		pcs	kg/100 pcs.	
<b>1801 SCH</b>	Grey	10	1.490	<b>5015 71 5</b>

**PS** Polystyrene /pc.

- 2 rail stands required per 14 units
- With 6 x 13 mm slot

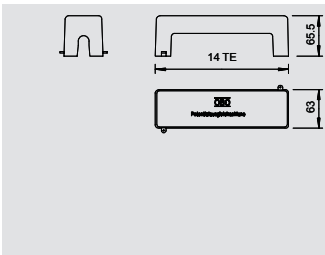

## Cover hood for 1801 VDE

Type	Colour	Pack.	Weight	Item No.
		pcs	kg/100 pcs.	
<b>1801 AH</b>	Grey	10	6.450	<b>5015 70 7</b>

**PS** Polystyrene /pc.

- 1 covering hood required per 14 division units
- Fastening to rail stands 1801/Sch
- Sealable

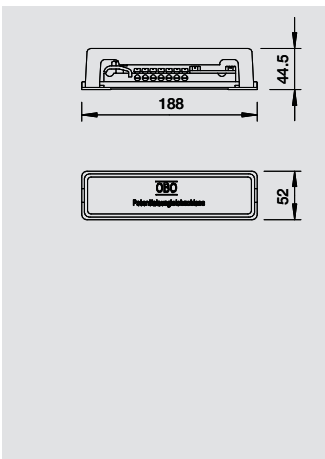

## Equipotential bonding rail with plastic base plate

Type	Colour	Pack.	Weight	Item No.
		pcs	kg/100 pcs.	
<b>1809</b>	Grey	1	23.000	<b>5015 07 3</b>

**CuZn** Brass /pc.

Equipotential bonding rail for equipotential bonding according to DIN VDE 0100-410/-540 and lightning protection equipotential bonding according to DIN VDE 0185-305

- Base plate and covering hood from polystyrene, grey
- Contact strip made of nickel-plated brass
- Screws and crossbar made of electrogalvanised steel
- Capable of carrying lightning current 100 kA (10/350)

Connection options:

- 7 x single or multi-core conductors to 25 mm<sup>2</sup> or fine-core conductors to 16 mm<sup>2</sup>
- 1 x round cable Rd 8-10
- 1 x flat strip to FL30 or round cable Rd 8-10

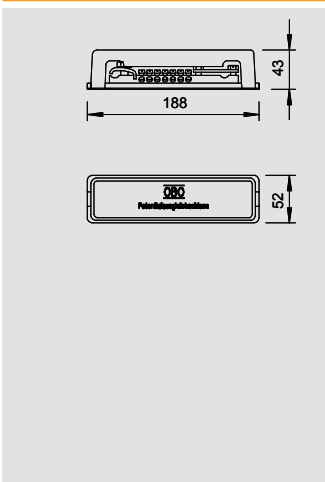

## Equipotential bonding rail with metal base plate

Type	Colour	Pack.	Weight	Item No.
		pcs	kg/100 pcs.	
<b>1809 M</b>	Grey	1	28.100	<b>5015 08 1</b>

**CuZn** Brass /pc.

Equipotential bonding rail with metal food for equipotential bonding according to DIN VDE 0100-410/-540 and lightning protection equipotential bonding according to DIN VDE 0185-305

- Cover hood from polystyrene, grey
- Base plate made of strip-galvanised steel
- Contact strip made of nickel-plated brass
- Screws and crossbar made of electrogalvanised steel
- Capable of carrying lightning current 100 kA (10/350)

Connection options:

- 7 x single or multi-core conductors to 25 mm<sup>2</sup> or fine-core conductors to 16 mm<sup>2</sup>
- 1 x round cable Rd 8-10
- 1 x flat strip to FL30 or round cable Rd 8-10



# Equipotential bonding rails for indoor use

## Cover hood for 1809



Type	Colour	Pack.	Weight	Item No.
		pcs	kg/100 pcs.	
<b>1809 30 AH</b>	Grey	50	0.120	<b>5015 20 0</b>

**PS** Polystyrene /pc.  
 • Replacement cover hood for equipotential bonding rail, type 1809

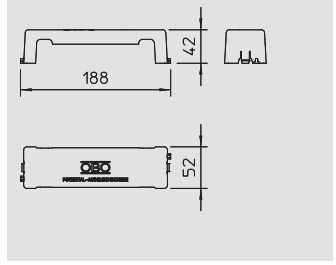

## Equipotential bonding rail for small systems



Type	Colour	Pack.	Weight	Item No.
		pcs	kg/100 pcs.	
<b>1809 BG</b>	Grey	1	9.000	<b>5015 50 2</b>

**CuZn** Brass /pc.  
 • Cover hood made of polystyrene, grey  
 • Base plate made of strip galvanised steel  
 • Contact strip and screws made of nickel-plated brass

Connection options:  
 • 3 x multi-core cables to 6 mm<sup>2</sup>  
 • 2 x multi-core cables to 16 mm<sup>2</sup>

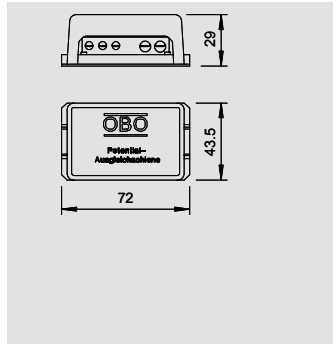

## Equipotential bonding rail, solid version

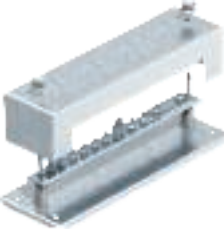

Type	Pack.	Weight	Item No.
	pcs	kg/100 pcs.	
<b>1810</b>	1	173.000	<b>5015 05 7</b>

**St** Steel **F** Hot-dip galvanised /pc.

• Base plate and screw-on cover hood, made of strip-galvanised steel  
 • Contact strip, made of electrogalvanised steel  
 • Screws and crossbar, made of hot-dip galvanised or electrogalvanised steel  
 Connection options:  
 • 6 x cables 6-16 mm<sup>2</sup>  
 • 1 x round cable Rd 8-10  
 • 1 x flat cable to FL40  
 • 2 x cable lug M8

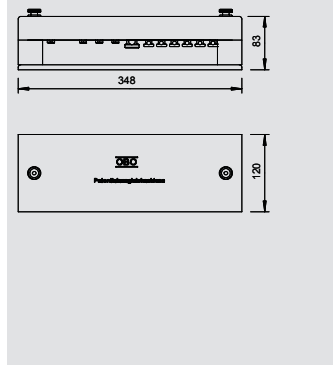

## Equipotential bonding rail, simple version



Type	Pack.	Weight	Item No.
	pcs	kg/100 pcs.	
<b>1808</b>	1	67.000	<b>5015 01 4</b>

**CuZn** Brass /pc.

• Clamp and crossbar, electrogalvanised steel  
 • Clamping element and contact strip, brass, screws, hot dipped galvanised steel  
 Connection options:  
 • 8 x cables to 25 mm<sup>2</sup>  
 • 1 x round cable Rd 8-10  
 • 1 x flat conductor to FL 40

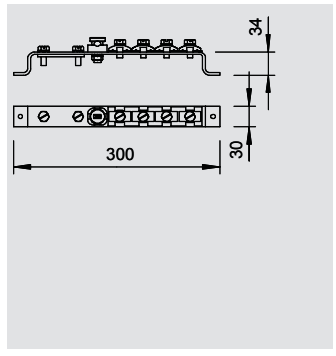

## Equipotential bonding bar for bathroom



Type	Pack.	Weight	Item No.
	pcs	kg/100 pcs.	
<b>1804</b>	5	3.000	<b>5015 55 3</b>

**CuZn** Brass /pc.

• Nickel-plated brass contact strip  
 • Screws and clamp made of electrogalvanised steel  
 Connection options:  
 • 6 cables 1.5-10 mm<sup>2</sup>  
 • 1 cable 6-16 mm<sup>2</sup>

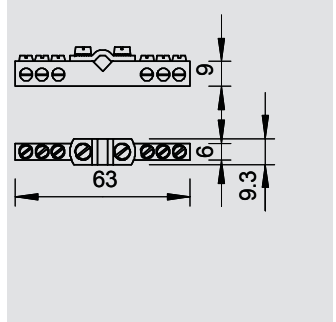

# Equipotential bonding rails for indoor use

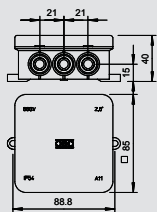

## Equipotential bonding rail for surface mounting with 1804

Type	Pack.	Weight	Item No.
	pcs	kg/100 pcs.	
<b>1804 AP</b>	10	12.000	<b>5015 55 7</b>

**PE** Polyethylene

/pc.

A 10/BP: Equipotential bonding rails for bathroom in housing

Connection options:

- 6x conductors 1.5-10 mm<sup>2</sup>
- 1x conductor 6-16 mm<sup>2</sup>
- Uncut
- With mounted potential equalisation rail 1804 in wet-room branch box A10

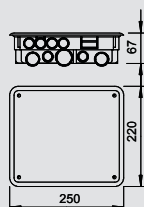

## Equipotential bonding rail for flush-mounting with 1809

Type	Pack.	Weight	Item No.
	pcs	kg/100 pcs.	
<b>1809 UP</b>	1	74.500	<b>5015 06 5</b>

**CuZn** Brass

/pc.

Connection options:

- 7 conductor to 25 mm<sup>2</sup>
- 1 round conductor Rd 8-10
- 1 flat conductor to FL30 or round conductor Rd 8-10
- With mounted potential equalisation rail 1809 (without covering hood)
- Pre-marked boxes for inserting required conductors and cover

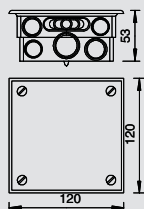
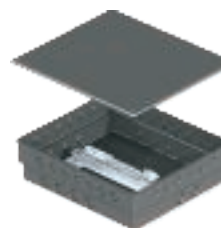

## Equipotential bonding rail for flush-mounting with 1804

Type	Pack.	Weight	Item No.
	pcs	kg/100 pcs.	
<b>1804 UP</b>	5	20.700	<b>5015 54 5</b>

**CuZn** Brass

/pc.

Connection options:

- 6 conductors 1.5-10 mm<sup>2</sup>
- 1 conductor 6-16 mm<sup>2</sup>
- Uncut
- With mounted potential equalisation rail 1804
- Pre-marked boxes for inserting required conductors and cover

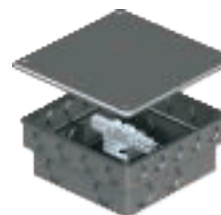

# Equipotential bonding systems for outdoor use



## Equipotential bonding rail for outside installation

Type	Colour	Pack.	Weight	Item No.
		pcs	kg/100 pcs.	
<b>1809 A</b>	<b>Black</b>	1	23.000	<b>5015 11 1</b>

V2A Stainless steel, grade 304 /pc.

Equipotential bonding rail for equipotential bonding according to DIN VDE 0100-410/-540 and lightning protection equipotential bonding according to DIN VDE 0185-305

- Base plate and cover hood from polystyrene
- Colour: black, UV-resistant
- Screws and crossbar made of VA
- Capable of carrying lightning current 100 kA (10/350)

### Connection options:

- 7 x single or multi-core conductors to 25 mm<sup>2</sup> or fine-core conductors to 16 mm<sup>2</sup>
- 1 x round cable Rd 8-10
- 1 x flat strip to FL30 or round cable Rd 8-10

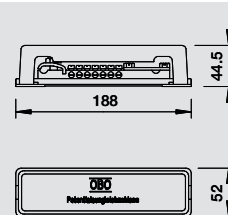

# Equipotential bonding rail for industrial application

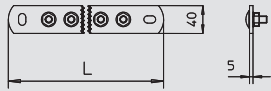

## Equipotential bonding rail BigBar for industrial application

Type	Number of connections	Width mm	Length mm	Height mm	Pack. pcs	Weight kg/100 pcs.	Item No.
<b>1802 5 VA</b>	5	40	246	6	1	90.000	<b>5015 85 4</b>
<b>1802 10 VA</b>	10	40	408.5	6	1	190.000	<b>5015 86 6</b>

**V2A** Stainless steel, grade 304 /pc.

- Main potential equalisation to VDE 0100 Part 410 and Part 540, and also lightning protection potential equalisation to VDE 0185-305 (IEC 62305)
- Insulation feet
- Quick, simple assembly of connection conductors to the contact rail using lock bolts M10
- The high-grade stainless steel versions (V2A) are suitable for outdoor use
- Complete with anchors and bolts for wall mounting
- With lock washer (DIN 137) for bolt locking against loosening (e.g. required in industry and Ex areas)

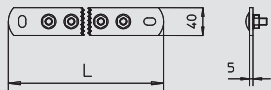

Type	Number of connections	Width mm	Length mm	Height mm	Pack. pcs	Weight kg/100 pcs.	Item No.
<b>1802 5 CU</b>	5	40	246	5	1	80.000	<b>5015 83 0</b>
<b>1802 6 CU</b>	6	40	278.5	5	1	98.400	<b>5015 83 2</b>
<b>1802 8 CU</b>	8	40	343.5	5	1	116.550	<b>5015 83 6</b>
<b>1802 10 CU</b>	10	40	408.5	5	1	180.000	<b>5015 84 2</b>
<b>1802 12 CU</b>	12	40	473.5	5	1	152.850	<b>5015 84 4</b>
<b>1802 14 CU</b>	14	40	538.5	5	1	171.000	<b>5015 84 7</b>
<b>1802 20 CU</b>	20	40	733.5	5	1	225.450	<b>5015 84 9</b>

**Cu** Copper /pc.

- Main potential equalisation to VDE 0100 Part 410 and Part 540, and also lightning protection potential equalisation to VDE 0185-305 (IEC 62305)
- Insulation feet
- Quick, simple assembly of connection conductors to the contact rail using lock bolts M10
- The high-grade stainless steel versions (V2A) are suitable for outdoor use
- Complete with anchors and bolts for wall mounting
- With lock washer (DIN 137) for bolt locking against loosening (e.g. required in industry and explosion-protected areas)

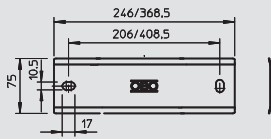

## Cover for BigBar equipotential bonding rail

Type	Number of connections	Pack. pcs	Weight kg/100 pcs.	Item No.
<b>1802 AH 5</b>	5	1	25.800	<b>5015 88 0</b>
<b>1802 AH 10</b>	10	1	36.300	<b>5015 88 4</b>

**V2A** Stainless steel, grade 304 /pc.

- Complete with all installation components

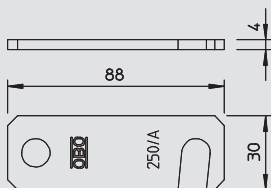

## Crossbar for equipotential bonding rail

Type	Connection option	Pack. pcs	Weight kg/100 pcs.	Item No.
<b>1802 KL</b>	FL20-FL40	1	7.000	<b>5015 89 0</b>

**V2A** Stainless steel, grade 304 /pc.

- To clamp the flat conductors 30 x 3.5 and 40 x 5
- Suitable for equipotential bonding rail BigBar, type 1802

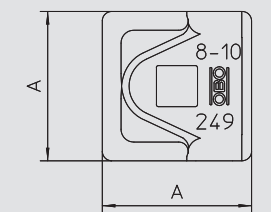

Type	Fit mm	Dimension A mm	Pack. pcs	Weight kg/100 pcs.	Item No.
<b>249 8-10 VA-OT</b>	Rd 8-10	40	100	3.130	<b>5311 55 4</b>

**V2A** Stainless steel, grade 304 /100 pc.

- For round cable Rd 8-10
- Suitable for M10 bolts

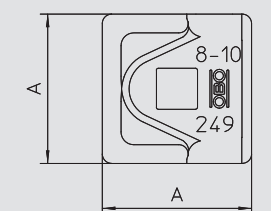
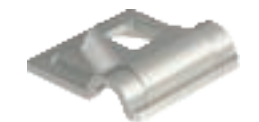

Type	Fit mm	Dimension A mm	Pack. pcs	Weight kg/100 pcs.	Item No.
<b>249 8-10 CU-OT</b>	Rd 8-10	40	100	3.580	<b>5311 53 0</b>

**Cu** Copper /100 pc.

- For round cable fastening RD 8-10
- Suitable for M10 bolts



# Equipotential bonding rail for industrial application



## Potential and earth connection block

Type	Dimension L	Dimension A	Dimension B	Dimension G	Pack.	Weight	Item No.
	mm	mm	mm	mm	pcs	kg/100 pcs.	
<b>1805 2 FT</b>	200	110	51	155	10	54.800	<b>5016 02 9</b>
<b>1805 4 FT</b>	302	212	153	257	20	77.000	<b>5016 03 7</b>
<b>1805 6 FT</b>	404	314	255	359	10	97.100	<b>5016 04 5</b>
<b>1805 2 VA</b>	200	110	51	155	10	54.800	<b>5016 09 6</b>
<b>1805 4 VA</b>	302	212	153	257	20	77.000	<b>5016 11 8</b>
<b>1805 6 VA</b>	404	314	255	359	10	97.100	<b>5016 12 6</b>

St Steel    
 V4A Stainless steel, grade 316 Ti    
 FT Hot-dip galvanised     /pc.

- With 2 mounting holes Ø 11 mm
- 1805/2: With 4 attaching holes
- 1805/4: With 8 attaching holes
- 1805/6: With 12 attaching holes

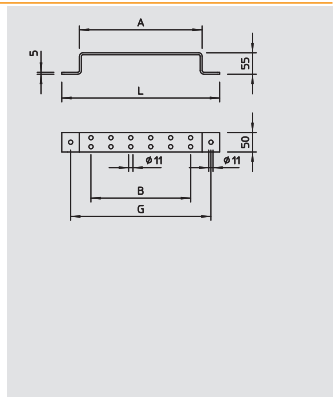

# Strip earthing clips

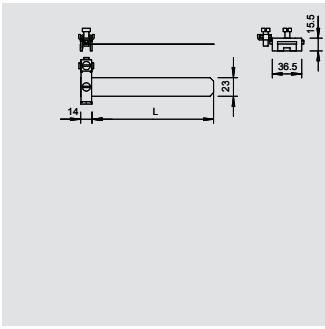

## Strip earthing clip VA

Type	For pipe Ø		Pack.	Weight	Item No.
	inch	mm			
927 1	3/8-11/2	17.2-48	10	7.780	5057 51 5
927 2	3/8-4	17.2-114	10	8.550	5057 52 3
927 4	3/8-6	17.2-185	10	8.900	5057 55 8

V2A Stainless steel, grade 304 /100 pc.

- For pipes of Ø 3/8 - 6"
- Connection options: Max. 2 cables 2.5-25 mm<sup>2</sup>
- Round conductor Rd 8
- Clip element, bolts and tightening strap made of rustproof stainless steel (VA)

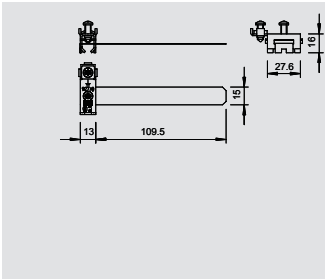

## Strip earthing clip, nickel-plated

Type	For pipe Ø	Pack.	Weight	Item No.
927 0	8-22	10	5.000	5057 50 7

CuZn Brass N Nickel-plated /100 pc.

- For pipe Ø 8-22 mm
- Connection options: max. 2 conductors 2.5-10 mm<sup>2</sup>
- Clip elements and screws from nickel-plated brass
- Tightening strip from high-grade stainless steel (V2A)

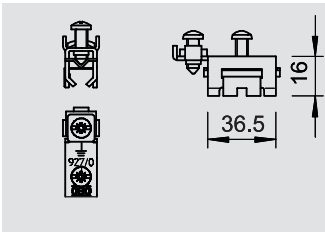

## Clamp lock for strip earthing clip

Type	Pack.	Weight	Item No.
927 SCH-K-VA	20	4.700	5057 93 0

V2A Stainless steel, grade 304 /100 pc.

- Connection option: max. 2 conductors 2.5-25 mm<sup>2</sup>
- Possible to connect round conductor Rd 8

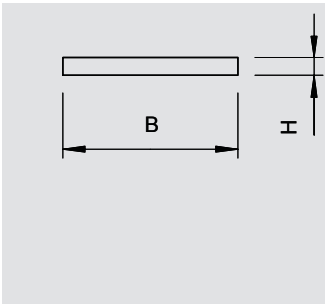

## Installation strip for strip earthing clip

Type	Dimension B	Dimension H	Pack.	Weight	Item No.
927 BAND-VA	23	0.3	40	6.000	5057 92 2

V2A Stainless steel, grade 304 /100 m

- 40 m roll
- Ready for transport and installation in unroll pack



# Earthing clips



## Earthing clip, type 925

Type	Dimension A	Clamping range D	Dimension x	For pipe Ø	Shipping box	Pack.	Weight	Item No.
	mm	mm	mm	inch	pcs	pcs	kg/100 pcs.	
925 1/4	48	11.5-13.5	2	1/4	300	25	4.100	5040 03 5
925 3/8	52	15.2-17.2	2	3/8	300	25	4.360	5040 05 1
925 1/2	56	19.3-21.3	2	1/2	300	25	4.788	5040 07 8
925 3/4	62	24.9-26.9	2	3/4	250	25	5.316	5040 09 4
925 1	70	31.7-33.7	2	1	250	25	5.956	5040 11 6
925 1 1/4	81	40.4-42.4	2	1 1/4	300	25	7.744	5040 13 2
925 1 1/2	88	46.3-48.3	2	1 1/2	240	20	9.615	5040 15 9

**St** Steel **G** Electrogalvanised /100 pc.

- For pipes 1/4"-1 1/2" or Ø 11.5-48.3 mm
- Connection options: conductors to 16 mm<sup>2</sup> with connecting terminal, riveted with brass and 1 cylinder screw M5 x 12
- To 1 1/2" with 2 cylinder screws M6 x 16 (G)

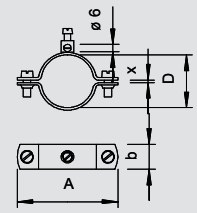

## Earthing terminal for fastening on earthing strap

Type	Shipping box	Pack.	Weight	Item No.
	pcs	pcs	kg/100 pcs.	
928	240	10	5.700	5040 50 7

**CuZn** Brass **N** Nickel-plated /100 pc.

- For use in bathtubs or shower lutes etc.
- Connection option: conductors to 16 mm<sup>2</sup>
- Clamping element with threaded connection M6, 1 hexagonal nut M6, 1 serrated dimension washer and 1 cylinder screw M5 x 8
- Clamping element, nut and screws from copper-plated brass
- Serrated washer from stainless steel; 2 washers from galvanised steel

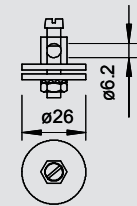

## Earthing clip, type 942

Type	Dimension A	Clamping range D	Dimension x	For pipe Ø	Shipping box	Pack.	Weight	Item No.
	mm	mm	mm	inch	pcs	pcs	kg/100 pcs.	
942 11	44	8-11	3.5	1/8	420	10	4.480	5038 01 4
942 15	50	13-15	3	1/4	320	10	4.800	5038 03 0
942 18	52	16-18	2	3/8	200	10	5.170	5038 05 7
942 22	55	19-22	3	1/2	180	10	5.550	5038 07 3
942 28	63	24-28	3	3/4	180	10	6.170	5038 08 1
942 35	71	30-35	5	1	120	10	8.570	5038 11 1
942 43	81	39-43	5	1 1/4	100	10	9.740	5038 13 8
942 49	86	44-49	5	1 1/2	100	10	10.540	5038 15 4

**Cu** Copper **N** Nickel-plated /100 pc.

- For pipes 1/8"-1 1/2" or Ø 8-49 mm
- Connection options: conductors to 16 mm<sup>2</sup>
- With attaching clamp and cylinder screw M6 x 16 from nickel-plated brass
- Top and bottom clip sections from nickel-plated copper

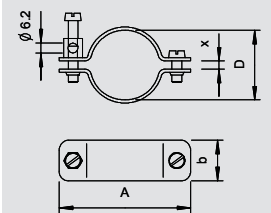

## Earthing strap, type 950

Type	Dimension A	Clamping range D	Dimension x	For pipe Ø	Shipping box	Pack.	Weight	Item No.
	mm	mm	mm	inch	pcs	pcs	kg/100 pcs.	
950 Z 1/4	45	12-14	2	1/4	300	10	5.830	5050 03 0
950 Z 3/8	50	15.5-17.5	2	3/8	180	10	6.020	5050 05 7
950 Z 1/2	54	20-22.5	2.5	1/2	120	10	7.000	5050 07 3
950 Z 3/4	61	25-28	3	3/4	120	10	7.620	5050 08 1
950 Z 1	66	31.5-34.5	3	1	150	10	8.410	5050 11 1
950 Z 1 1/4	78	40.5-43.5	3	1 1/4	160	10	10.030	5050 13 8
950 Z 1 1/2	84	46.5-49.5	3	1 1/2	150	10	10.410	5050 15 4
950 Z 1 3/4	88	51-54	3	1 3/4	100	10	11.820	5050 17 0
950 Z 2	96	58.5-61.5	3	2	80	10	12.150	5050 19 7

**Zn** Die-cast zinc **G** Electrogalvanised /100 pc.

- For pipes Ø 1/4"-2"
- Connection options: conductors to 35 mm<sup>2</sup> or round conductors to Ø 6 mm
- With captive pressure strip, 2 cylinder screws M6 x 16 and 1 hex-head screw M6 x 16 from galvanised steel, top and bottom part of clip from die-cast zinc

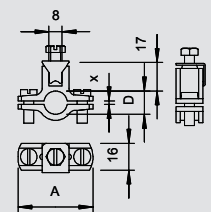



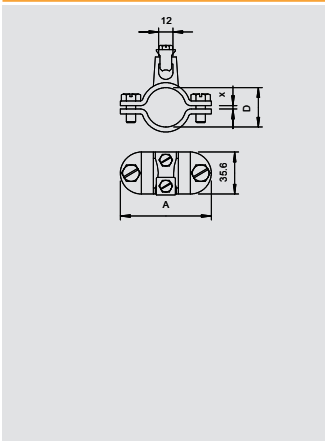

Earthing clip, type 952

Type	Dimension A mm	Clamping range D mm	Dimension x mm	For pipe Ø inch	Shipping box pcs	Pack. pcs	Weight kg/100 pcs.	Item No.
952 Z 1/2	65	18.5-21.5	3	1/2	50	5	24.880	5052 07 6
952 Z 3/4	71	24-27	3	3/4	50	5	26.780	5052 09 2
952 Z 1	77	30.5-33.5	3	1	50	5	28.560	5052 11 4
952 Z 1 1/4	87	39.5-42.5	3	1 1/4	50	5	32.200	5052 13 0
952 Z 1 1/2	94	45.5-48.5	3	1 1/2	20	5	34.720	5052 15 7
952 Z 2	105	57-60	3	2	30	5	38.520	5052 18 1



- St** Steel      **FT** Hot-dip galvanised      /100 pc.
- For pipes 1/2-2" or Ø 11.5-60 mm
  - Connection options: conductors 16-70 mm<sup>2</sup> and/or round conductors to Rd 10 with captive pressure strip from stainless steel
  - With 2 hexagonal bolts M6 x 16 and 2 hexagonal bolts M6 x 20 from hot-dip galvanised steel
  - Top section of clip with cast contact point from die-cast zinc, bottom section of clip from hot-dip galvanised steel

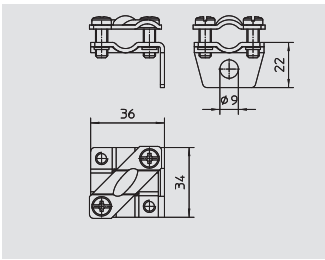

Earthing terminal type 951

Type	Shipping box pcs	Pack. pcs	Weight kg/100 pcs.	Item No.
951	120	10	5.400	5051 50 9



- V2A** Stainless steel, grade 304      /100 pc.
- Longitudinal and transverse conductor routing
  - With 1 attaching hole Ø 9 mm
  - With 2 cylinder bolts M6 x 16

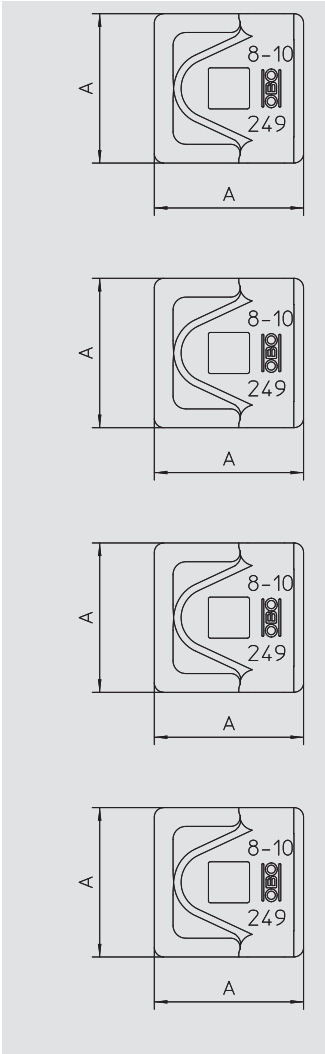

Connection terminal, equipotential bonding, Rd 8-10 mm

Type	Fit	Dimension A mm	Pack. pcs	Weight kg/100 pcs.	Item No.
249 8-10 ST-OT	Rd 8-10	40	100	3.240	5311 50 3

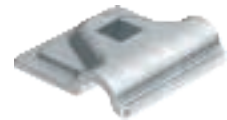

- St** Steel      **FT** Hot-dip galvanised      /100 pc.
- For round cable fastening RD 8-10
  - Suitable for M10 bolts

Type	Dimension A mm	Fit	Pack. pcs	Weight kg/100 pcs.	Item No.
249 8-10 ALU-OT	44	Rd 8-10	100	2.100	5311 58 5



- Al** Aluminium      /100 pc.
- For round conductor fastening Rd 8-10
  - Suitable for M10 bolts
- Application: Equipotential bonding on PV frames

Type	Fit	Dimension A mm	Pack. pcs	Weight kg/100 pcs.	Item No.
249 8-10 VA-OT	Rd 8-10	40	100	3.130	5311 55 4



- V2A** Stainless steel, grade 304      /100 pc.
- For round cable Rd 8-10
  - Suitable for M10 bolts

Type	Fit	Dimension A mm	Pack. pcs	Weight kg/100 pcs.	Item No.
249 8-10 CU-OT	Rd 8-10	40	100	3.580	5311 53 0



- Cu** Copper      /100 pc.
- For round cable fastening RD 8-10
  - Suitable for M10 bolts



# Earthing clips



## Connection terminal, equipotential bonding, Rd 16 mm

Type	Fit	Pack.	Weight	Item No.
	mm	pcs	kg/100 pcs.	
<b>249 VA-OT</b>	16	100	5.700	<b>5311 57 3</b>

V2A Stainless steel, grade 304

- For round conductor fastening RD 16
- Suitable for M10 bolts

/100 pc.

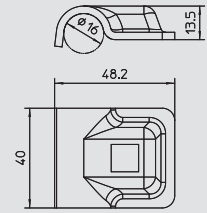

## Earth connection terminal for round cable and flat conductor

Type	Shipping box	Pack.	Weight	Item No.
	pcs	pcs	kg/100 pcs.	
<b>937 50</b>	100	10	11.750	<b>5043 01 8</b>

St Steel FT Hot-dip galvanised

- For round and flat conductors
- Fit: cable 50 mm<sup>2</sup> x max. FL 40
- Rd 8 x max. FL 40
- With 2 hexagonal bolts M6 x 20 (F)

/100 pc.

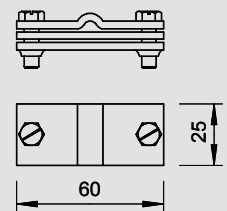

## Earthing terminal for cables and flat conductors

Type	Shipping box	Pack.	Weight	Item No.
	pcs	pcs	kg/100 pcs.	
<b>939</b>	150	25	5.932	<b>5043 10 7</b>

St Steel G Electrogalvanised

- For cables to 16 mm<sup>2</sup> and flat conductors
- Fit: cable to 16 mm<sup>2</sup> x max. FL 30
- With riveted brass connection terminal and one cylinder bolt, M5 x 12, with two cylinder bolts, M6 x 16

/100 pc.

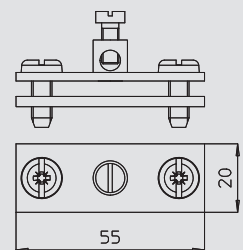

## Clip branch terminal

Type	Pack.	Weight	Item No.
	pcs	kg/100 pcs.	
<b>470 4-16</b>	50	2.856	<b>5064 01 5</b>

CuZn Brass N Nickel-plated

- For conductors 4-16 mm<sup>2</sup>
- Fit: 4-16 mm<sup>2</sup> x 4-16 mm<sup>2</sup>
- With 4 cylinder bolts M4 x 16

/100 pc.

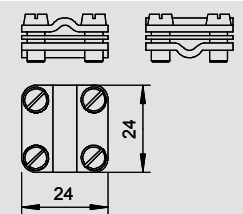

## Earthing screw with fastening thread

Type	Dimension L	Dimension I	Cross-section	SW	Thread	Pack.	Weight	Item No.
	mm	mm	mm <sup>2</sup>	mm		pcs	kg/100 pcs.	
<b>B 33020</b>	22	8	25	18	M6	50	3.100	<b>6404 00 6</b>
<b>B 33021</b>	26	10	35	21	M6	50	4.800	<b>6404 01 4</b>

CuZn Brass Bright

Earthing screw for fastening the equipotential bonding wire to the cable support system.

/100 pc.

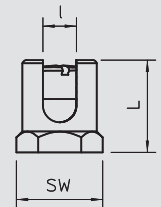

## Clamp clips for screen connection

Type	Clamping range D	Pack.	Weight	Item No.
	mm	pcs	kg/100 pcs.	
<b>2056N SAS 8 VA</b>	4-8	100	2.900	<b>1167 00 6</b>
<b>2056N SAS 12 VA</b>	8-12	100	3.700	<b>1167 01 4</b>
<b>2056N SAS 16 VA</b>	12-16	100	4.200	<b>1167 02 2</b>
<b>2056N SAS 22 VA</b>	16-22	100	4.850	<b>1167 03 0</b>
<b>2056N SAS 28 VA</b>	22-28	100	6.600	<b>1167 04 9</b>

V2A Stainless steel, grade 304

For electrical connection of the braided shield of stripped cables. Delivery complete with counter-trough; pressure trough and VA counter-trough. A cable screen for protection against electromagnetic influences, can also contribute towards equipotential bonding as both ends are connected to the reference potential.

/100 pc.

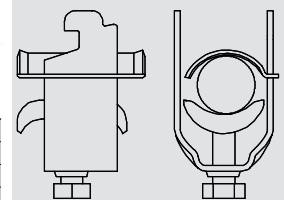

## Profile rail

Type	Version	Dimension b x h	Material thickness	Length	Bundle	Weight	Item No.
		mm	mm	mm	m	kg/100 m	
<b>2066 2M F</b>	Unperforated	25 x 12	1.5	2,000	20	65.000	<b>1117 02 5</b>
<b>2066 2M FS</b>	Unperforated	25 x 12	1.5	2,000	20	58.300	<b>1117 03 3</b>

St Steel FS Strip-galvanised F Hot-dip galvanised

Profile rail, unperforated, slot width 11 mm.



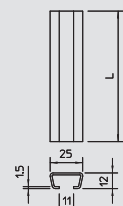

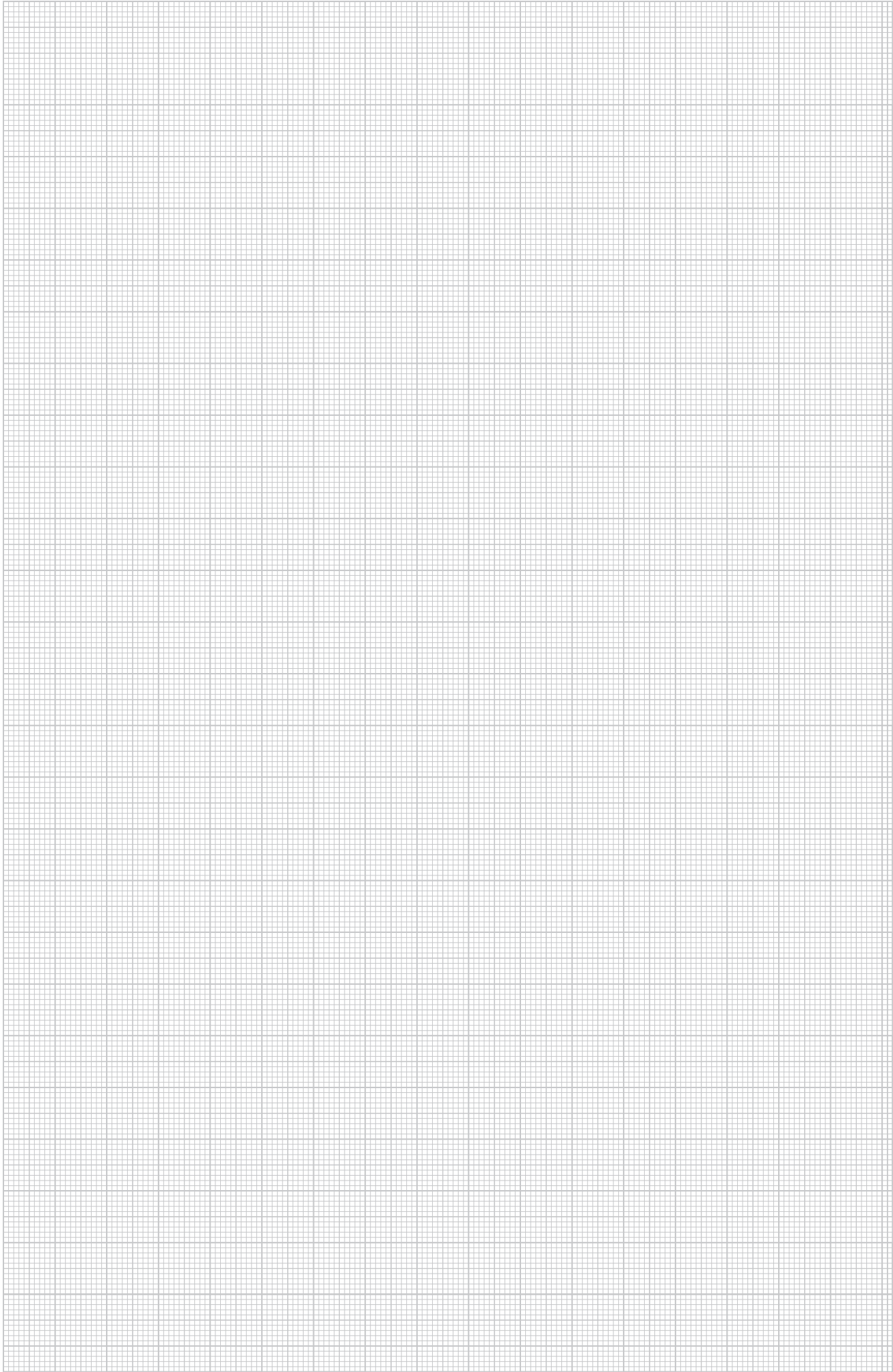
/100 m







## Earthing systems

	Cable material	310
	Deep earther and plate earther	312
	Connection material	318
	Holders and accessories	326

# Cable material

## Galvanised steel flat conductor



Type	Dimension b x h mm	Cross- section mm <sup>2</sup>	Normal ring ca. m	Normal ring ca. kg	Weight kg/100 m	Item No.
5052 DIN 20X2.5	20 x 2.5	50	122	50	41.000	5019 34 0
5052 DIN 25X3	25 x 3	75	84	50	59.700	5019 34 2
5052 DIN 30X3	30 x 3	90	71	50	70.650	5019 34 4
5052 DIN 30X3.5	30 x 3.5	105	30	25	84.000	5019 34 5
5052 DIN 30X3.5	30 x 3.5	105	60	50	84.000	5019 34 7
5052 DIN 30X4	30 x 4	120	52	50	97.000	5019 35 0
5052 DIN 40X4	40 x 4	160	40	50	128.000	5019 35 5
5052 DIN 40X5	40 x 5	200	30	50	162.000	5019 36 0

**St** Steel **FT** Hot-dip galvanised /100 m

- According to DIN EN 50164-2 (VDE 0185 Part 202)
- Meets the requirements of VDE 0185-305 (IEC 62305)
- Zinc coating: 500 g/m<sup>2</sup> (approx. 70 µm)
- For lightning protection, earthing systems and ring equipotential bonding

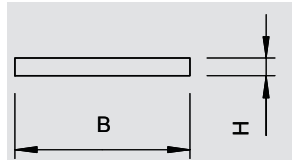

## Stainless steel flat conductor



Type	Dimension b x h mm	Cross- section mm <sup>2</sup>	Normal ring ca. m	Normal ring ca. kg	Weight kg/100 m	Item No.
5052 V2A 30X3.5	30 x 3.5	105	50	42	82.500	5018 50 1
5052 V4A 30X3.5	30 x 3.5	105	50	42	82.425	5018 70 6
5052 V4A 30X3.5	30 x 3.5	105	25	21	82.425	5018 73 0

**V2A** Stainless steel, grade 304 **V4A** Stainless steel, grade 316 Ti /100 m

- According to DIN EN 50164-2 (VDE 0185 Part 202)
- Corresponds to the requirements of VDE 0185-305 (IEC 62305)
- According to the foundation earthing standard DIN 18014, V4A is required in the earth
- For use in areas at risk of corrosion
- For lightning protection, earthing systems and ring equipotential bonding

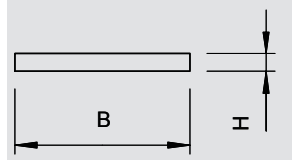

## Copper flat conductor



Type	Dimension b x h mm	Cross- section mm <sup>2</sup>	Normal ring ca. m	Normal ring ca. kg	Weight kg/100 m	Item No.
FL 20-CU	20 x 2.5	50	45	20	44.500	5021 80 4

**Cu** Copper /100 m

- According to DIN EN 50164-2 (VDE 0185 Part 202)
- Meets the requirements of VDE 0185-305 (IEC 62305)
- Version: E-Cu S7 F24 soft
- For lightning protection, earthing systems and ring equipotential bonding

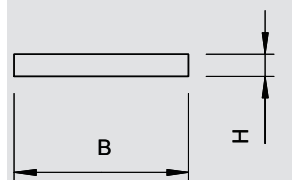

## Round cable, galvanised steel



Type	Nominal size Ø mm	Cross- section mm <sup>2</sup>	Normal ring ca. m	Normal ring ca. kg	Weight kg/100 m	Item No.
RD 8-FT	8	50	125	50	40.000	5021 08 1
RD 10	10	78	80	50	63.000	5021 10 3

**St** Steel **FT** Hot-dip galvanised /100 m

- According to DIN EN 50164-2 (VDE 0185 part 202)
- Conforms to the requirements according to DIN VDE 0185-305 (IEC 62305)
- RD 10 can also be used in earth
- Zinc coating: 350 g/m<sup>2</sup> (approx. 50 µm)

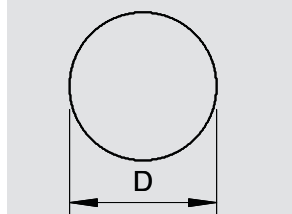

## Round cable, galvanised steel with PVC jacketing



Type	Colour	Dimen- sion d mm	Dimen- sion D mm	Cross- section mm <sup>2</sup>	Normal ring ca. m	Normal ring ca. kg	Weight kg/100 m	Item No.
RD 10-PVC	Black	10	13	78	75	50	67.200	5021 16 2

**St** Steel **FT** Hot-dip galvanised /100 m

- Conforms to the requirements according to VDE V 0185-305, (IEC 62305)
- Zinc coating: 350 g/m<sup>2</sup> (approx. 50 µm)
- With PVC sheathing

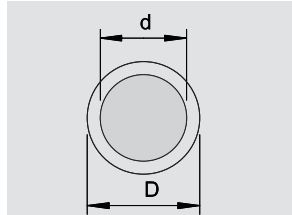

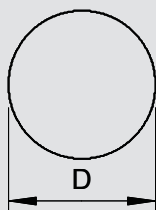

## Round cable, aluminium

Type	Nominal size Ø mm	Cross-section mm <sup>2</sup>	Normal ring ca. m	Normal ring ca. kg	Weight kg/100 m	Item No.
<b>RD 8-ALU</b>	8	50	150	20	13.500	<b>5021 28 6</b>
<b>RD 8-ALU-T</b>	8	50	150	20	13.500	<b>5021 29 4</b>
<b>RD 10-ALU</b>	10	78	95	20	21.000	<b>5021 30 8</b>



**Al** Aluminium

/100 m

- According to DIN EN 50164-2 (VDE 0185 Part 202)
- Meets the requirements of VDE 0185-305 (IEC 62305)
- RD 8/ALU: Semi-hard (E-ALMgSi0.5 corresponds to DIN 48801)
- RD 8/ALU-T: Twistable (E-ALMgSi0.5 corresponds to DIN 48801)
- RD 10/ALU: Pure aluminium (E-Al corresponds to DIN 48801)
- AL and ALMgSi may not be routed directly on, in or under the plaster, mortar or concrete nor underground

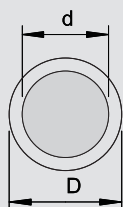

## Round cable, aluminium, with PVC sheathing

Type	Colour	Dimen- sion d mm	Dimen- sion D mm	Cross- section mm <sup>2</sup>	Normal ring ca. m	Normal ring ca. kg	Weight kg/100 m	Item No.
<b>RD 8-PVC</b>	Cream	8	11	50	75	15	20.000	<b>5021 33 2</b>



**Al** Aluminium

/100 m

- Meets the requirements of VDE 0185-305 (IEC 62305)
- With PVC jacketing (halogen-free)
- Suitable for routing on, in or under plasterwork, mortar or concrete

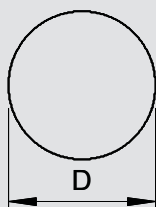

## Round cable, stainless steel

Type	Nominal size Ø mm	Cross-section mm <sup>2</sup>	Normal ring ca. m	Normal ring ca. kg	Weight kg/100 m	Item No.
<b>RD 8-V2A</b>	8	50	125	50	40.000	<b>5021 23 5</b>
<b>RD 10-V2A</b>	10	78	50	32	63.000	<b>5021 22 7</b>
<b>RD 10-V2A</b>	10	78	80	50	63.000	<b>5021 23 9</b>
<b>RD 8-V4A</b>	8	50	125	50	40.000	<b>5021 64 4</b>
<b>RD 10-V4A</b>	10	78	50	32	63.000	<b>5021 64 2</b>
<b>RD 10-V4A</b>	10	78	80	50	63.000	<b>5021 64 7</b>



**V2A** Stainless steel, grade 304 **V4A** Stainless steel, grade 316 Ti

/100 m

- According to DIN EN 50164-2 (VDE 0185 Part 202)
- Corresponds to the requirements of VDE 0185-305 (IEC 62305)
- RD 10-V4A for applications in the earth
- According to the foundation earthing standard DIN 18014, V4A is required in the earth

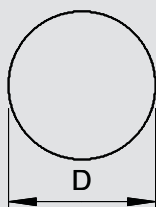

## Round cable, copper

Type	Nominal size Ø mm	Cross-section mm <sup>2</sup>	Normal ring ca. m	Normal ring ca. kg	Weight kg/100 m	Item No.
<b>RD 8-CU</b>	8	50	100	45	45.000	<b>5021 48 0</b>
<b>RD 10-CU</b>	10	78	50	35	70.000	<b>5021 50 2</b>



**Cu** Copper

/100 m

- According to DIN EN 50164-2 (VDE 0185 Part 202)
- Meets the requirements of VDE 0185-305 (IEC 62305)

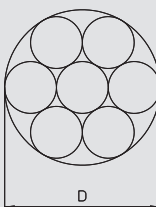

## Copper cable

Type	Dimen- sion D mm	Individual wires	Cross-section mm <sup>2</sup>	Normal ring ca. m	Normal ring ca. kg	Weight kg/100 m	Item No.
<b>S 9-CU</b>	9	7 x Ø3	50	100	44.5	44.500	<b>5021 65 0</b>
<b>S 11-CU</b>	10.5	19 x Ø2.1	70	50	30	58.600	<b>5021 65 4</b>



**Cu** Copper

/100 m

- Conforms to the requirements according to DIN VDE 0185-305 (IEC 62305)
- 7 individual wires of Ø 3 mm (overall cross-section 50 mm<sup>2</sup>)

# Deep earther and plate earther

## Earthing rod for standard applications

Type	Length/External Ø		Pack.	Weight	Item No.
	mm	mm			
<b>219 20 ST FT</b>	1,000	20	5	250.000	<b>5000 74 2</b>
<b>219 20 ST FT</b>	1,500	20	5	360.000	<b>5000 75 0</b>
<b>219 25 ST FT</b>	1,500	25	5	573.000	<b>5000 76 9</b>

**St** Steel **FT** Hot-dip galvanised /pc.

- High corrosion resistance
- Zinc support 70 µm
- With peg and bore for linking together
- Round pegs with two knurls
- Conforms to the requirements according to VDE 0185-305 (IEC 62305)
- Short-circuit current I<sub>k</sub> (50 Hz), time 1 s, max. temp 300 °C: 7.9 kA (219/20 ST)

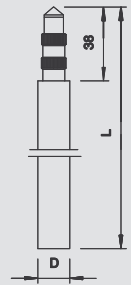

## LightEarth earthing rod

Type	Length/External Ø		Pack.	Weight	Item No.
	mm	mm			
<b>LE ERDER FT</b>	1,000	25	5	157.600	<b>5000 29 7</b>
<b>LE ERDER FT</b>	1,500	25	5	220.000	<b>5000 30 0</b>

**St** Steel **FT** Hot-dip galvanised /pc.

- Expandable earthing rod system for erecting earthing connections (type A)
- Also suitable for difficult soil conditions
- The LightEarth earthing system is connected using the pre-mounted sleeve
- Satisfies requirements according to DIN VDE 0185-305 (IEC 62305)
- For use with antenna earthing systems, lightning earthing systems, etc.

Type	Length/External Ø		Pack.	Weight	Item No.
	mm	mm			
<b>LE ERDER V4A</b>	1,500	25	5	235.000	<b>5000 33 5</b>

**V4A** Stainless steel, grade 316 L /pc.

- Expandable earthing rod system for erecting earthing connections (type A)
- Also suitable for difficult soil conditions
- The LightEarth earthing system is connected using the pre-mounted sleeve
- Satisfies requirements according to DIN VDE 0185-305 (IEC 62305)
- For use with antenna earthing systems, lightning earthing systems, etc.

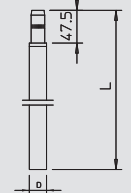
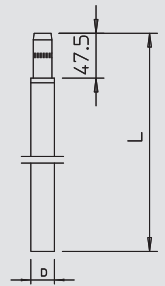

## BP earthing rod

Type	Length/External Ø		Pack.	Weight	Item No.
	mm	mm			
<b>219 20 BP FT</b>	1,500	20	5	360.000	<b>5000 94 7</b>
<b>219 25 BP FT</b>	1,500	25	5	573.000	<b>5000 95 5</b>

**St** Steel **FT** Hot-dip galvanised /pc.

219/..BP: Earthing rod connection with high contact force

- DIN 48852, Form Z, "BP" system (Bundespost = German Post)
- Very good contacting properties with lead ball in the bore hole
- With peg and bore for linking together
- Version FT with zinc support, min. 70 µm
- Conforms to the requirements according to DIN VDE 0185-305 (IEC 62305)

Type	Length/External Ø		Pack.	Weight	Item No.
	mm	mm			
<b>219 20 BP V4A</b>	1,000	20	5	250.000	<b>5000 85 8</b>
<b>219 20 BP V4A</b>	1,500	20	5	365.000	<b>5000 86 6</b>

**V4A** Stainless steel, grade 316 /pc.

- DIN 48852, Z shape, "BP" system (Bundespost = German Post)
- Very good contacting properties with lead ball in the bore hole
- With peg and bore for linking together
- Version FT with zinc support, min. 70 µm
- Conforms to the requirements according to VDE 0185-305 (IEC 62305)
- Short-circuit current I<sub>k</sub> (50 Hz), time 1 s, max. temp. 300 °C: 4.5 kA (219/20BP-VA)

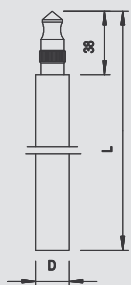
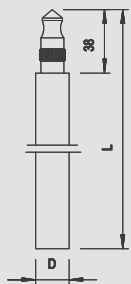





## BP earthing rod with copper sheath

Type	Length mm	External Ø mm	Pack. pcs	Weight kg/100 pcs.	Item No.
<b>219 20 BP CU</b>	1,500	20	6	365.400	<b>5000 50 5</b>

**St** Steel **Cu** Copper-plated /pc.

- DIN 48852, Form Z, BP system (Bundespost = German Post)
- Very good contacting properties with lead insert in the bore hole
- With peg and bore for linking together
- Cu version with a 0.5 mm copper sheath
- Conforms to the requirements according to DIN VDE 0185-305 (IEC 62305)

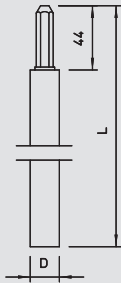

## OMEX earthing rod

Type	Length mm	External Ø mm	Pack. pcs	Weight kg/100 pcs.	Item No.
<b>219 20 OMEX FT</b>	1,500	20	5	365.400	<b>5000 01 7</b>
<b>219 20 OMEX FT</b>	2,000	20	5	491.400	<b>5000 20 3</b>
<b>219 25 OMEX FT</b>	1,500	25	5	577.200	<b>5000 02 5</b>

**St** Steel **FT** Hot-dip galvanised /pc.

- DIN 48852, Form Z, OMEX system
- With peg and bore for linking together
- With hardened steel pins
- Version FT with zinc support, min. 60 µm
- Conforms to the requirements according to DIN VDE 0185-305 (IEC 62305)

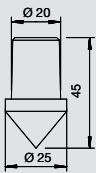

## Impact point for LightEarth earthing rod

Type	For deep earthers Ø mm	Pack. pcs	Weight kg/100 pcs.	Item No.
<b>LE SPITZE</b>	25	10	10.000	<b>3041 40 9</b>

**St** Steel **FT** Hot-dip galvanised /pc.

- Suitable for LightEarth system

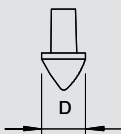

## Impact point for ST and BP earthing rod

Type	For deep earthers Ø mm	Pack. pcs	Weight kg/100 pcs.	Item No.
<b>1819 20BP</b>	20	10	3.500	<b>3041 21 2</b>
<b>1819 25BP</b>	25	10	6.700	<b>3041 95 6</b>

**TG** Cast iron **FT** Hot-dip galvanised /pc.

- Suitable for ST and BP system

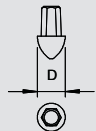

## Impact point for OMEX earthing rod

Type	For deep earthers Ø mm	Pack. pcs	Weight kg/100 pcs.	Item No.
<b>1819 20</b>	20	10	3.300	<b>3041 20 4</b>
<b>1819 25</b>	25	10	4.900	<b>3041 25 5</b>

**TG** Cast iron **FT** Hot-dip galvanised /pc.

- Suitable for OMEX system
- DIN 48852, Form SP

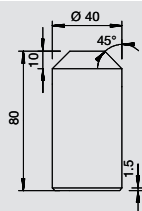

## Impact head for LightEarth earthing rod

Type	For deep earthers Ø mm	Pack. pcs	Weight kg/100 pcs.	Item No.
<b>LE KOPF</b>	25	1	70.000	<b>3042 30 8</b>

**St** Steel **FT** Hot-dip galvanised /pc.

- Suitable for LightEarth system
- For driving earthing rods using hand-held hammer
- Hardened



# Deep earther and plate earther



## Impact head for earthing rods ST, BP and OMEX

Type	For deep earthers Ø mm	Pack. pcs	Weight kg/100 pcs.	Item No.
1820 20	20	1	62.600	3042 20 0
1820 25	25	1	70.000	3042 25 1

**St** Steel /pc.

- Suitable for ST, BP and OMEX systems
- Hardened
- DIN 48852, Form SP

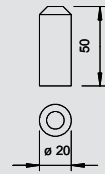

## Hammer insert, type 2500, for earthing rods ST, BP and OMEX

Type	For deep earthers Ø mm	Pack. pcs	Weight kg/100 pcs.	Item No.
2500 20	20	1	120.800	3043 20 7
2500 25	25	1	143.100	3043 25 8

**St** Steel /pc.

- Manufactured by Cobra BBM 47 SPA-Super, Tex11 and COBRA 248
- Fits earthing rod system ST, BP and OMEX
- Hardened

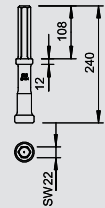

## Hammer insert, type 2510, for earthing rods ST, BP and OMEX

Type	For deep earthers Ø mm	Pack. pcs	Weight kg/100 pcs.	Item No.
2510 20	20	1	310.000	3043 31 2

**St** Steel /pc.

- Manufactured by Atlas Copco, type FB 60 S-Super
- Fits earthing rod system ST, BP and OMEX
- Hardened

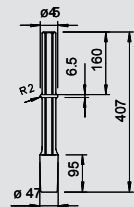

## Hammer insert, type 2520, for earthing rods ST, BP and OMEX

Type	For deep earthers Ø mm	Pack. pcs	Weight kg/100 pcs.	Item No.
2520 20	20	1	197.000	3043 70 3
2520 25	25	1	197.000	3043 75 4

**St** Steel /pc.

- Manufactured by Wacker BHF 25, BHF 30S, EHU 25/220
- Fits earthing rod system ST, BP and OMEX
- Hardened

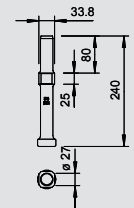

## Hammer insert, type 2530, for earthing rods ST, BP and OMEX

Type	For deep earthers Ø mm	Pack. pcs	Weight kg/100 pcs.	Item No.
2530 20	20	1	125.000	3043 40 1
2530 25	25	1	125.000	3043 45 2

**St** Steel /pc.

- Manufactured by Bosch USH 10, HSH 10
- Fits earthing rod system ST, BP and OMEX
- Hardened

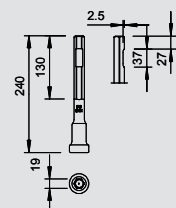

## Hammer insert, type 2531, for earthing rods ST, BP and OMEX

Type	For deep earthers Ø mm	Pack. pcs	Weight kg/100 pcs.	Item No.
2531 20	20	1	200.000	3043 90 8

**St** Steel /pc.

- Make: Bosch GSH 27, USH 27 (WAF 28 mm)
- Suitable for ST, BP and OMEX earthing rod systems
- Hardened



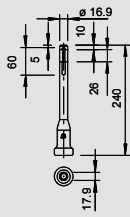

## Hammer insert, type 2535, for earthing rods ST, BP and OMEX

Type	For deep earthers Ø mm	Pack. pcs	Weight kg/100 pcs.	Item No.
2535 20	20	1	100.000	3043 91 6
2535 25	25	1	100.000	3044 91 2

**St** Steel

/pc.

- Manufactured by Hilti TE 52/42, TE 72/60, TE 92
- Fits earthing rod system ST, BP and OMEX
- Hardened

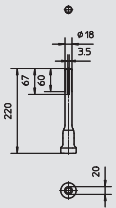

## Hammer insert, type 2536, for earthing rods ST, BP and OMEX

Type	For deep earthers Ø mm	Pack. pcs	Weight kg/100 pcs.	Item No.
2536 20	20	1	63.000	3044 90 4
2536 25	25	1	61.000	3044 83 1

**St** Steel

/pc.

- Fits earthing rod system ST, BP and OMEX
- For vibration hammers with SDS- Max/TEY- mounting
- Hardened



## Hammer insert for LightEarth earthing rod

Type	Version	Pack. pcs	Weight kg/100 pcs.	Item No.
LE HAMMER-W	Wacker	1	132.000	3043 60 6
LE HAMMER-H	Hilti	1	76.000	3043 61 0
LE HAMMER-B	Bosch	1	87.000	3043 61 4
LE HAMMER-SDS-M	SDS-Max	1	76.000	3043 60 2
LE HAMMER-AC	Atlas Copco	1	76.000	3043 61 8
LE HAMMER-B-II	-	1	200.000	3043 62 8

**St** Steel

/pc.

- Suitable for LightEarth system
- 3043606 for Wacker (BHF 25, BHF 30S)
- 3043610 for Hilti (TE 52/42, TE72/60, TE92)
- 3043614 for Bosch (USH 10, HSH 10)
- 3043602 for SDS-Max
- 3043618 for Atlas Copco (Hexagon seat)
- 3043628 for Bosch GSH27/UH27 (11304) / HS28 (12314)  
Hitachi H65SD  
Makita HM 1500B / HM1800
- Hardened



## Interception/earth entry rod, rounded-off on both sides

Type	Length mm	Nominal size Ø mm	Pack. pcs	Weight kg/100 pcs.	Item No.
101 A-1500	1,500	16	10	240.000	5400 15 5

**St** Steel

**FT** Hot-dip galvanised

/100 pc.

- Full material Ø 16 mm
- Rounded on both sides
- Suitable for FangFix stand system

Type	Length mm	Nominal size Ø mm	Pack. pcs	Weight kg/100 pcs.	Item No.
200 V4A-1500	1,500	16	10	242.000	5420 50 4
200 V4A-2000	2,000	16	1	320.000	5420 53 9

**V4A** Stainless steel, grade 316 Ti

/100 pc.

- Both ends rounded

Type	Length mm	Nominal size Ø mm	Pack. pcs	Weight kg/100 pcs.	Item No.
101 A-CU	1,500	16	10	272.100	5400 62 7

**Cu** Copper

/100 pc.

- Full material Ø 16 mm
- Rounded on both sides
- Suitable for FangFix stand system



# Deep earther and plate earther

## Interception/earth entry rod with connection tabs

Type	Length mm	Nominal size Ø mm	Pack. pcs	Weight kg/100 pcs.	Item No.
101 F1500	1,500	16	10	240.000	5424 15 1
101 F2000	2,000	16	10	320.000	5424 20 8

- St** Steel **FT** Hot-dip galvanised /100 pc.
- With 2 attaching holes Ø 12 mm
  - One end rounded

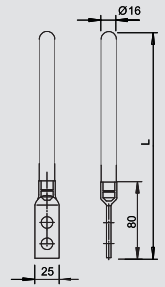

## Earth entry rod, tapered and partially insulated

Type	Length mm	Nominal size Ø mm	Pack. pcs	Weight kg/100 pcs.	Item No.
204 KS-2000	2,000	16/10	1	230.000	5430 01 1
204 KS-2500	2,500	16/10	1	310.000	5430 06 2

- St** Steel **F** Hot-dip galvanised /pc.
- 16 mm earth entry with 10 mm connection
  - With mounted heat-shrinkable sleeve (corrosion protection)

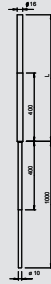

## Earth entry rod with separating piece and connector

Type	Fit mm	Pack. pcs	Weight kg/100 pcs.	Item No.
204 KL-1500	Rd 8-10	10	260.700	5430 15 1

- St** Steel /100 pc.
- With separating piece type 223 DIN and connector type 5002 DIN

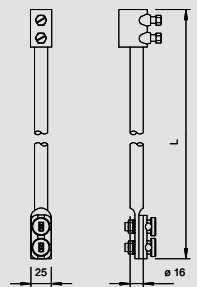

## Profile earthing rod connection with connecting lug

Type	Length mm	Pack. pcs	Weight kg/100 pcs.	Item No.
213 1000 DIN	1,000	5	240.500	5003 00 8
213 1500 DIN	1,500	5	364.500	5003 01 6
213 2000 DIN	2,000	5	488.400	5003 02 4
213 2500 DIN	2,500	3	612.400	5003 03 2
213 3000 DIN	3,000	3	736.400	5003 04 0

- St** Steel **FT** Hot-dip galvanised /pc.
- Cross-profile 50 x 50 x 3 mm
  - With connecting strap
  - 1 through hole Ø 13 mm
  - 2 through holes Ø 11 mm

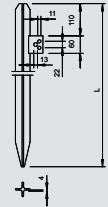

## Profile earthing rod connection with strip steel lug

Type	Length mm	Pack. pcs	Weight kg/100 pcs.	Item No.
213 1000 M	1,000	3	403.700	5003 25 3
213 1500 M	1,500	3	527.600	5003 26 1
213 2000 M	2,000	3	651.600	5003 28 8
213 2500 M	2,500	3	783.800	5003 29 6
213 3000 M	3,000	3	899.500	5003 31 8

- St** Steel **FT** Hot-dip galvanised /pc.
- With 2 m strip steel section FL 30 x 3.5
  - With 2 through holes Ø 11 mm
  - Does not conform to DIN 48852, Part 1

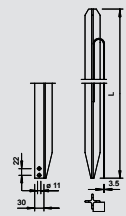

## Profile earthing rod connection with round cable lug

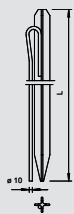

Type	Length mm	Pack. pcs	Weight kg/100 pcs.	Item No.
<b>213 2000 F</b>	2,000	3	610.900	<b>5003 78 4</b>

**St** Steel **FT** Hot-dip galvanised /pc.

- With 2 m round conductor lugs Rd 10
- Does not conform to DIN 48852, Part 1



## Earthing plate

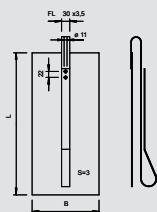

Type	Dimension B x L x S mm	Pack. pcs	Weight kg/100 pcs.	Item No.
<b>1816 F-500X1000</b>	500 x 1000 x 3	1	1,329.300	<b>5009 22 7</b>
<b>1816 F-1000X1000</b>	1000 x 1000 x 3	1	2,700.000	<b>5009 23 5</b>

**St** Steel **FT** Hot-dip galvanised /pc.

- With 3 m strip steel section FL30 x 3.5
- With 2 attaching holes Ø 11 mm



# Connection material

## Connection clip for earthing rod to round cables Rd 8–10



Type	For deep earthers Ø mm	Dimension A mm	Dimension B mm	Pack. pcs	Weight kg/100 pcs.	Item No.
2710 20	20	84	114	5	39.900	5001 21 8
2710 25	25	89	119	5	42.300	5001 22 6

**St** Steel **FT** Hot-dip galvanised /pc.

- ST, BP, OMEX and LightEarth systems
- On round conductor Rd 8-10
- Including connector 5001 DIN

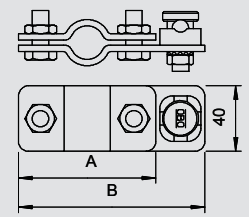

## Connection clip for earthing rod on flat conductor



Type	For deep earthers Ø mm	Dimension A mm	Dimension B mm	Pack. pcs	Weight kg/100 pcs.	Item No.
2730 25 FT	25	89	119	5	38.800	5001 41 2
2730 20 FT	20	84	114	5	35.900	5001 40 4

**St** Steel **FT** Hot-dip galvanised /pc.

- ST, BP, OMEX and LightEarth systems
- On flat conductors
- Including hex-head screw for attaching flat conductors

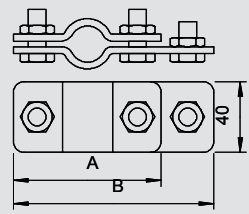

Type	For deep earthers Ø mm	Dimension A mm	Dimension B mm	Pack. pcs	Weight kg/100 pcs.	Item No.
2730 20 VA	20	84	114	5	35.900	5001 36 6

**V2A** Stainless steel, grade 304 /pc.

- ST, BP, OMEX and LightEarth systems
- On flat conductors
- Including hex-head screw for attaching flat conductors

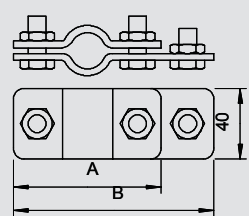

## Connection clip for earthing rod, universal



Type	Dimension A mm	For deep earthers Ø mm	Fit mm	Pack. pcs	Weight kg/100 pcs.	Item No.
2760 20 FT	101	20	Rd 8-10/FL40	5	32.400	5001 64 1
2760 B-20 FT	101	20	Rd 8-10/FL40	20	32.400	5001 74 9
2760 25 FT	110	25	Rd 8-10/FL40	5	38.400	5001 66 8

**St** Steel **FT** Hot-dip galvanised /pc.

- Suitable for attaching round conductors Rd 8-10 or flat conductors to FL 40
- With separator plate
- Installed with 2 hexagonal bolts M10 x 30 and 2 hexagonal nuts M10

Type	Dimension A mm	For deep earthers Ø mm	Fit mm	Pack. pcs	Weight kg/100 pcs.	Item No.
2760 20 VA	101	20	Rd 8-10/FL40	5	32.400	5001 61 7
2760 B-20 VA	101	20	Rd 8-10/FL40	20	32.400	5001 62 5
2760 20 V4A	101	20	Rd 8-10/FL40	20	32.400	5001 63 3
2760 25 V4A	110	25	Rd 8-10/FL40	5	32.400	5001 67 2

**V2A** Stainless steel, grade 304 **V4A** Stainless steel, grade 316 L /pc.

- Suitable for attaching round conductors Rd 8-10 or flat conductors to FL 40
- With separator plate
- Installed with 2 hexagonal bolts M10 x 30 and 2 hexagonal nuts M10

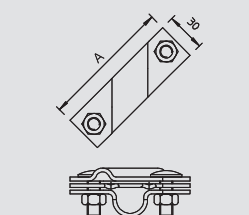
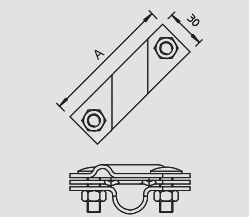

## Connection clip for earthing rod or cables



Type	For deep earthers Ø mm	Fit mm	Pack. pcs	Weight kg/100 pcs.	Item No.
2745 20 MS	20	7-12,5/S95 mm <sup>2</sup>	5	16.000	5001 56 0

**CuZn** Brass **Cu** Copper-plated /pc.

- For earthing rod connector Ø 20 or conductors 95 mm<sup>2</sup>
- For round conductor attachments Rd 7-12.5 with hexagonal bolts M10 x 25, copper (Cu)

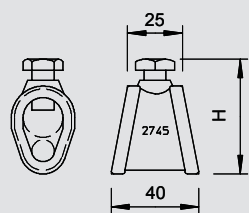

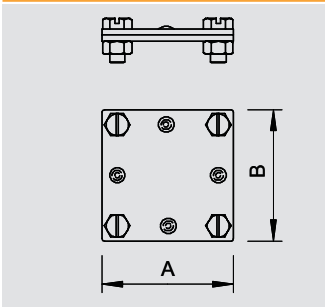

**Cross-connector for flat conductor**

Type	Fit	Dimension A	Dimension B	Pack.	Weight	Item No.
	mm	mm	mm	pcs	kg/100 pcs.	
<b>255 A-FL30 FT</b>	max. FL30	60	60	20	11.500	<b>5314 53 4</b>

- St** Steel **FT** Hot-dip galvanised /100 pc.
- Fit: max. FL 30 x FL 30
  - Without separator plate
  - Installed with 4 hexagonal bolts M6 x 20 (F)

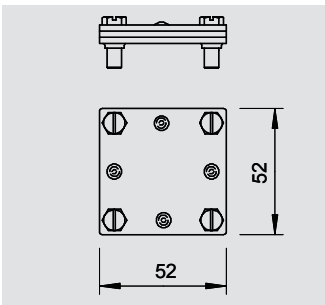
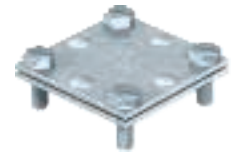

**Cross-connector for flat conductor, with intermediate plate**

Type	Fit	Dimension A	Dimension B	Pack.	Weight	Item No.
	mm	mm	mm	pcs	kg/100 pcs.	
<b>255 30</b>	max. FL30	52	52	20	16.650	<b>5314 51 8</b>

- St** Steel **FT** Hot-dip galvanised /100 pc.
- Fit: max. FL 30 x FL 30
  - With separator plate
  - Installed with 4 hexagonal bolts M6 x 20 (F)

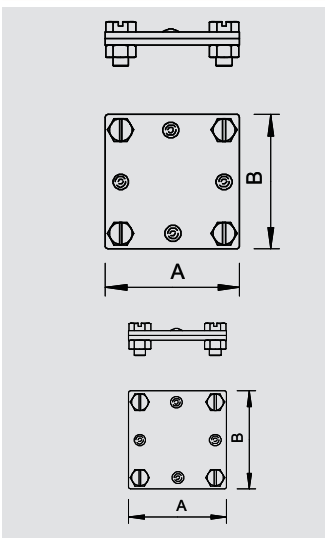
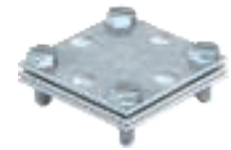

**DIN cross-connector for flat conductor**

Type	Fit	Dimension A	Dimension B	Pack.	Weight	Item No.
	mm	mm	mm	pcs	kg/100 pcs.	
<b>256 A-DIN 30 FT</b>	max. FL30	60	60	10	27.800	<b>5314 65 8</b>
<b>256 A-DIN 40 FT</b>	max. FL40	80	80	10	38.800	<b>5314 66 6</b>

- St** Steel **FT** Hot-dip galvanised /100 pc.
- Fit: max. FL 30 x FL 30, max. FL 40 x max. FL 40 (F)
  - Without separator plate
  - Installed with 4 hexagonal bolts M8 x 25 and 4 hexagonal nuts M8
  - DIN 48845, Form H

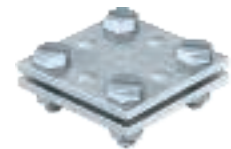

Type	Fit	Dimension A	Dimension B	Pack.	Weight	Item No.
	mm	mm	mm	pcs	kg/100 pcs.	
<b>256 A-DIN 30 VA</b>	max. FL30	60	60	25	27.800	<b>5314 72 0</b>
<b>256 A-DIN 30 V4A</b>	max. FL30	60	60	10	26.400	<b>5314 65 9</b>

- V2A** Stainless steel, grade 304 **V4A** Stainless steel, grade 316 Ti /100 pc.
- Seat: max. FL 30 x FL 30 or max FL 40 x FL 40
  - Without intermediate plate
  - Mounted with 4 hexagonal bolts M8 x 25 and 4 M8 hexagonal nuts

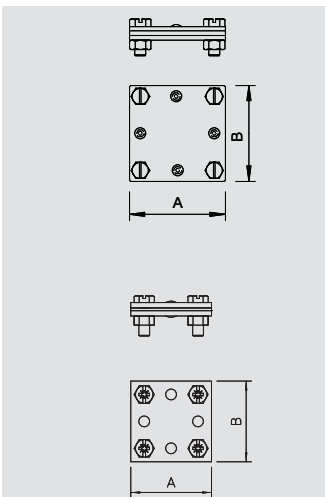
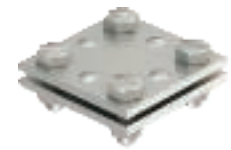

**DIN cross-connector for flat conductor, with intermediate plate**

Type	Fit	Dimension A	Dimension B	Pack.	Weight	Item No.
	mm	mm	mm	pcs	kg/100 pcs.	
<b>256 DIN 30 FT</b>	max. FL30	60	60	10	35.860	<b>5314 61 5</b>
<b>256 DIN 40 FT</b>	max. FL40	80	80	10	54.650	<b>5314 62 3</b>

- St** Steel **FT** Hot-dip galvanised /100 pc.
- Seat: max. FL 30 x FL 30 or max FL 40 x FL 40
  - With intermediate plate
  - Mounted with 4 hexagonal bolts M8 x 25 and 4 M8 hexagonal nuts

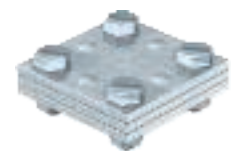

Type	Fit	Dimension A	Dimension B	Pack.	Weight	Item No.
	mm	mm	mm	pcs	kg/100 pcs.	
<b>256 DIN 30 V4A</b>	max. FL30	60	60	10	29.100	<b>5314 61 6</b>

- V4A** Stainless steel, grade 316 Ti /100 pc.
- Seat: max. FL 30 x FL 30 or max FL 40 x FL 40
  - With intermediate plate
  - Mounted with 4 hexagonal bolts M8 x 25 and 4 M8 hexagonal nuts

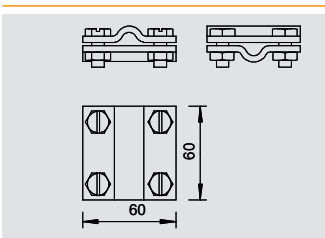
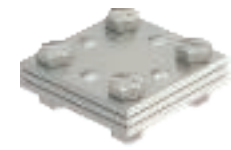

**Cross-connector for round cables Rd 8–10**

Type	Fit	Pack.	Weight	Item No.
	mm	pcs	kg/100 pcs.	
<b>253 8X8</b>	Rd 8-10	25	30.700	<b>5312 60 4</b>

- St** Steel **F** Hot-dip galvanised /100 pc.
- Fit: Rd 8-10 x Rd 8-10
  - Installed with 4 hexagonal bolts M8 x 25 and 4 hexagonal nuts M8 (F)



# Connection material

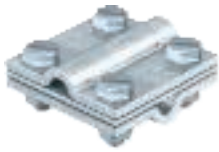

## Cross-connector with intermediate plate for round cables, Rd 8-10

Type	Fit	Pack.	Weight	Item No.
	mm	pcs	kg/100 pcs.	
<b>252 8-10 FT</b>	Rd 8-10	25	33.530	<b>5312 31 0</b>

**St** Steel **FT** Hot-dip galvanised /100 pc.

- Fit: Rd 8-10 x Rd 8-10
- With separator plate
- Installed with 4 hexagonal bolts M8 x 25 and 4 hexagonal nuts M8

Type	Fit	Pack.	Weight	Item No.
	mm	pcs	kg/100 pcs.	
<b>252 8-10 V4A</b>	Rd 8-10	25	33.530	<b>5312 31 8</b>

**V4A** Stainless steel, grade 316 Ti /100 pc.

- Fit: Rd 8-10 x Rd 8-10
- With separator plate
- Installed with 4 hexagonal bolts M8 x 25 and 4 hexagonal nuts M8

Type	Fit	Pack.	Weight	Item No.
	mm	pcs	kg/100 pcs.	
<b>252 8-10 CU</b>	Rd 8-10	25	38.940	<b>5312 41 8</b>

**Cu** Copper /100 pc.

- Fit: Rd 8-10 x Rd 8-10
- With separator plate
- Installed with 4 hexagonal bolts M8 x 25 and 4 hexagonal nuts M8

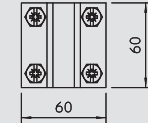
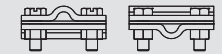
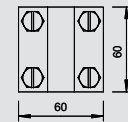
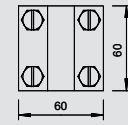

## Cross-connector for round cables Rd 8-10 x Rd 16

Type	Fit	Pack.	Weight	Item No.
	mm	pcs	kg/100 pcs.	
<b>253 10X16</b>	Rd 8-10 x 16	25	29.800	<b>5312 80 9</b>

**St** Steel **F** Hot-dip galvanised /100 pc.

- Fit: Rd 8-10 x Rd 16
- Installed with 4 hexagonal bolts M8 x 25 and 4 hexagonal nuts M8 (F)

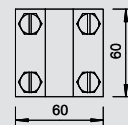
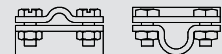

## Cross-connector with intermediate plate for round cables, Rd 8-10 x Rd 16

Type	Fit	Pack.	Weight	Item No.
	mm	pcs	kg/100 pcs.	
<b>252 8-10X16 FT</b>	Rd 8-10 x 16	25	38.800	<b>5312 34 5</b>

**St** Steel **FT** Hot-dip galvanised /100 pc.

- Fit: Rd 8-10 x Rd 16
- With separator plate
- Installed with 4 hexagonal bolts M8 x 25 and 4 hexagonal nuts M8
- DIN 48845, Form E

Type	Fit	Pack.	Weight	Item No.
	mm	pcs	kg/100 pcs.	
<b>252 8-10x16 V4A</b>	Rd 8-10 x 16	25	39.000	<b>5312 34 6</b>

**V4A** Stainless steel, grade 316 Ti

- Fit: Rd 8-10 x Rd 16
- With separator plate
- Installed with 4 hexagonal bolts M8 x 25 and 4 hexagonal nuts M8
- DIN 48845, Form E

Type	Fit	Pack.	Weight	Item No.
	mm	pcs	kg/100 pcs.	
<b>252 8-10X16 CU</b>	Rd 8-10 x 16	25	43.985	<b>5312 44 2</b>

**Cu** Copper /100 pc.

- Fit: Rd 8-10 x Rd 16
- With separator plate
- Installed with 4 hexagonal bolts M8 x 25 and 4 hexagonal nuts M8
- DIN 48845, Form E

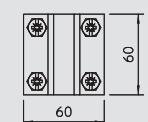
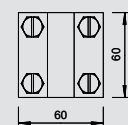
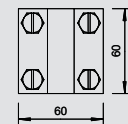



**Cross-connector for flat conductors and round cables**

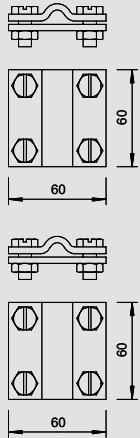

Type	Fit	Pack.	Weight	Item No.
	mm	pcs	kg/100 pcs.	
<b>252 8-10xFL30 FT</b>	8-10 x FL30	25	28.500	<b>5312 65 5</b>

**St** Steel **F** Hot-dip galvanised /100 pc.

- Fit: Rd 8-10 x FL 30
- Installed with 4 hexagonal bolts M8 x 25 and 4 hexagonal nuts M8

Type	Fit	Pack.	Weight	Item No.
	mm	pcs	kg/100 pcs.	
<b>252 8-10xFL30V4A</b>	8-10 x FL30	25	28.500	<b>5312 65 6</b>

**V4A** Stainless steel, grade 316 Ti

- Fit: Rd 8-10 x FL 30
- Installed with 4 hexagonal bolts M8 x 25 and 4 hexagonal nuts M8



**Cross-connector for flat conductors and round cables**

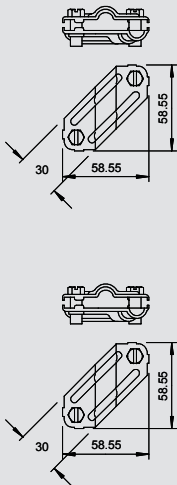

Type	Fit	Pack.	Weight	Item No.
	mm	pcs	kg/100 pcs.	
<b>250</b>	Rd 8-10/FL30	25	10.260	<b>5312 90 6</b>

**St** Steel **FT** Hot-dip galvanised /100 pc.

- Fit: Rd 8-10 x Rd 8-10
- Fit: Rd 8-10 x FL 30
- Fit: FL 30 x FL 30
- Installed with 2 hexagonal bolts M8 x 20 (F)

Type	Fit	Pack.	Weight	Item No.
	mm	pcs	kg/100 pcs.	
<b>250 VA</b>	Rd 8-10/FL30	25	10.260	<b>5312 92 2</b>
<b>250 V4A</b>	Rd 8-10/FL30	25	10.260	<b>5312 92 5</b>

**V2A** Stainless steel, grade 304 **V4A** Stainless steel, grade 316 Ti /100 pc.

- Fit: Rd 8-10 x Rd 8-10
- Fit: Rd 8-10 x FL 30
- Fit: FL 30 x FL 30
- Installed with 2 hexagonal bolts M8 x 20 (F)



**Diagonal clamp**

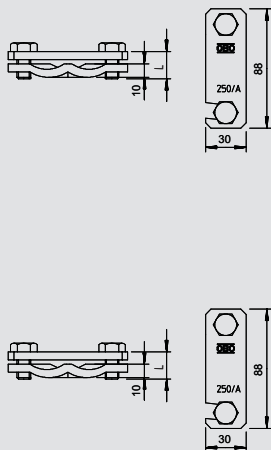

Type	Dimension L	Fit	Pack.	Weight	Item No.
	mm	mm	pcs	kg/100 pcs.	
<b>250 A-FT</b>	40	Rd 6-22/max. FL50	25	28.800	<b>5313 01 5</b>
<b>250 AS-FT</b>	20	Rd 6-22/max. FL50	25	26.000	<b>5313 03 1</b>

**St** Steel **FT** Hot-dip galvanised /100 pc.

- For reinforced steels Ø 6-22 mm and flat conductor 50 x 4
- Installed with screws M10 x 40
- AS version with screws M10 x 20
- Simple installation with open slot

Type	Dimension L	Fit	Pack.	Weight	Item No.
	mm	mm	pcs	kg/100 pcs.	
<b>250 A-VA</b>	40	Rd 6-22/max. FL50	25	28.800	<b>5313 02 3</b>

**V2A** Stainless steel, grade 304 /100 pc.

- For reinforced steels Ø 6-22 mm and flat conductor 50 x 4
- Installed with screws M10 x 40
- AS version with screws M10 x 20
- Simple installation with open slot



**Diagonal clamp with bolt**

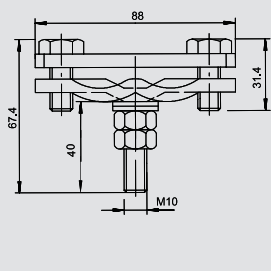

Type	Dimension L	Fit	Pack.	Weight	Item No.
	mm	mm	pcs	kg/100 pcs.	
<b>250 A-BO</b>	25	Rd 6-22/max. FL50	25	30.000	<b>5313 06 6</b>

**St** Steel **F** Hot-dip galvanised /100 pc.

- For reinforced steels Ø 6-22 mm and flat conductor 50 x 4
- Installed with screws M10 x 25
- Simple installation with open slot
- With flange-welded bolts M10 x 40, inc. 2 washers and 2 nuts



# Connection material



## Parallel clamp

Type	Fit	Pack.	Weight	Item No.
	mm	pcs	kg/100 pcs.	
<b>259 A ST</b>	Ø 10-20	25	18.800	<b>5315 55 7</b>
<b>259 A FT</b>	Ø 10-20	25	18.800	<b>5315 51 4</b>

**St** Steel **FT** Hot-dip galvanised /100 pc.

- For connecting reinforced steels Ø 10–20 mm
- Mounted with M10 x 40 bolts



Type	Fit	Pack.	Weight	Item No.
	mm	pcs	kg/100 pcs.	
<b>259 A VA</b>	Ø 10-20	25	18.800	<b>5315 52 2</b>

**V2A** Stainless steel, grade 304 /100 pc.

- For connecting reinforced steels Ø 10–20 mm
- Mounted with M10 x 40 bolts

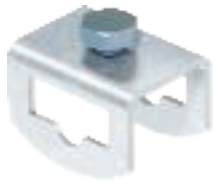
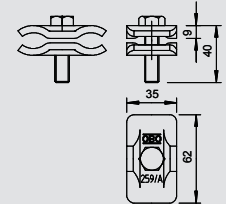
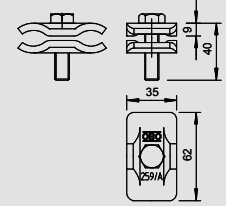

## Variable earthing terminal

Type	Fit	Pack.	Weight	Item No.
	mm	pcs	kg/100 pcs.	
<b>1813 KL</b>	FL30 x Rd 8-10	50	18.000	<b>5014 42 5</b>

**St** Steel **FT** Hot-dip galvanised /pc.

- Suitable for connecting Rd 10 x FL 30, FL 30 x FL 30
- Quick mounting using a hexagonal bolt M10 x 20 (F)

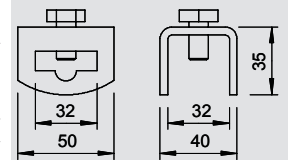

## Connection terminal for round cable

Type	Fit	Pack.	Weight	Item No.
	mm	pcs	kg/100 pcs.	
<b>1818</b>	Rd 8-10	10	17.600	<b>5012 01 5</b>

**St** Steel **FT** Hot-dip galvanised /100 pc.

- For connecting round conductor Rd 8-10
- With 1 hexagonal bolt M12 x 40, 1 hexagonal nut M12 and 1 lock washer, stainless steel

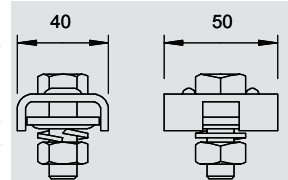

## Connection terminal for reinforced steels

Type	Fit	Pack.	Weight	Item No.
	mm	pcs	kg/100 pcs.	
<b>1814 ST</b>	FL30x5 x Rd8-14	25	20.000	<b>5014 47 6</b>
<b>1814 FT</b>	FL30x5 x Rd8-14	25	20.000	<b>5014 46 8</b>

**St** Steel **FT** Hot-dip galvanised /pc.

- For reinforced steels with diameters 8-14 mm and FL 30 x 5
- Simple mounting through open slot
- Side suspension possible

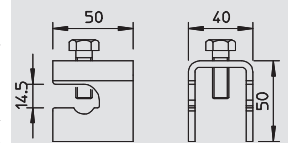

## Earthing fixed point

Type	Thread	Pack.	Weight	Item No.
		pcs	kg/100 pcs.	
<b>205 B-M10 VA</b>	M10	25	25.500	<b>5420 00 8</b>
<b>205 B-M12 VA</b>	M12	25	25.500	<b>5420 01 6</b>

**V4A** Stainless steel, grade 316 L /pc.

- Connection to earthing systems, arrestors and reinforcement
- Contact plate: Ø 79 mm, made of rustproof stainless steel (V4A)
- Clamping bolt Ø 10 mm, rustproof (V2A)
- Incl. plastic cover for simple installation

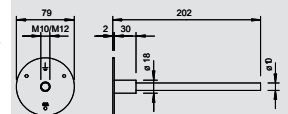

## End piece

Type	Dimension D	Pack.	Weight	Item No.
	Ø mm	pcs	kg/100 pcs.	
<b>5011</b>	11	50	7.064	<b>5304 99 7</b>

**St** Steel **FT** Hot-dip galvanised /100 pc.

- For attaching to steel structures or bolting to earthing fixed points
- For attachments: round conductor Rd 8-10 and flat conductor FL 30 x 3.5
- 2 attaching holes Ø 11 mm
- 1 attaching holes Ø D mm

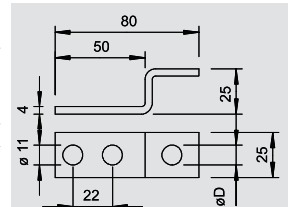

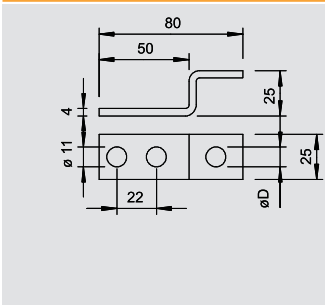

## End piece

Type	Dimension D Ø mm	Pack. pcs	Weight kg/100 pcs.	Item No.
5011 VA M10	11	50	7.064	5334 93 4
5011 VA M12	13	50	7.048	5334 94 2



V4A Stainless steel, grade 316 Ti

/100 pc.

- For attaching to steel structures or bolting to earthing fixed points
- For attachments: round conductor Rd 8-10 and flat conductor FL 30 x 3.5
- 2 attaching holes Ø 11 mm
- 1 attaching holes Ø D mm

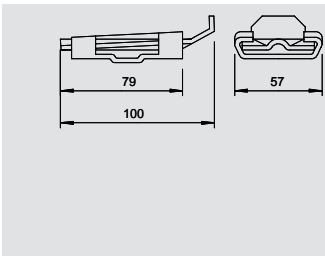

## Wedge connector

Type	Fit mm	Pack. pcs	Weight kg/100 pcs.	Item No.
1813 DIN	10/FL30 x FL30	5	20.000	5014 21 2



St Steel FT Hot-dip galvanised

/pc.

- DIN 48834, Form A
- Suitable for connecting Rd 10 x FL 30, FL 30 x FL 30
- Quick installation with high contact force

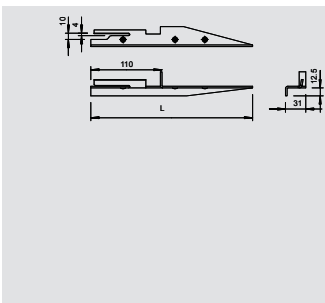

## Spacer

Type	Fit mm	Length mm	Pack. pcs	Weight kg/100 pcs.	Item No.
1811	10/FL30 x 3,5	250	25	19.000	5014 01 8
1811 L	10/FL30 x 3,5	400	25	31.500	5014 02 6



St Steel FT Hot-dip galvanised

/pc.

- For professional laying of round conductors and flat conductors according to DIN VDE 0185-305 (IEC 62305)
- DIN 48833
- Suitable for mounting round conductors Rd 10 or flat conductors FL 30 x 3.5

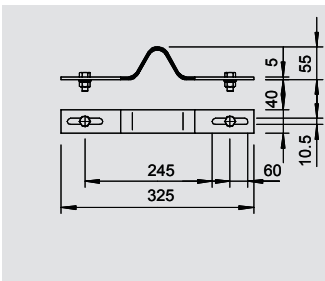

## Expansion piece

Type	Pack. pcs	Weight kg/100 pcs.	Item No.
1807	25	27.000	5016 14 2



Al Aluminium

/pc.

- For expansion joints when laying foundation earthers
- With 2 hexagonal bolts M10 x 30
- 2 hexagonal nuts M10, 2 steel washers, hot galvanised, and 2 rustproof steel serrated washers

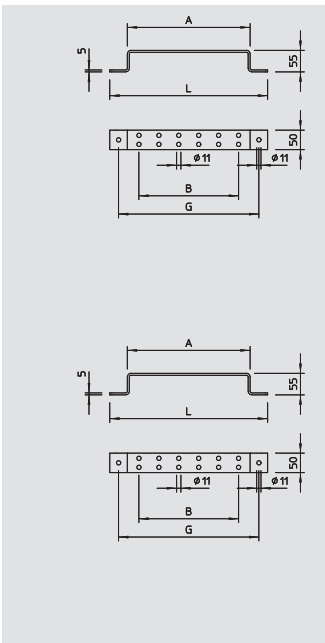

## Earthing connection block

Type	Dimension L mm	Dimension A mm	Dimension B mm	Dimension G mm	Pack. pcs	Weight kg/100 pcs.	Item No.
1805 2 FT	200	110	51	155	10	54.800	5016 02 9
1805 4 FT	302	212	153	257	20	77.000	5016 03 7
1805 6 FT	404	314	255	359	10	97.100	5016 04 5



St Steel FT Hot-dip galvanised

/pc.

- With 2 mounting holes Ø 11 mm
- 1805/2: With 4 attaching holes
- 1805/4: With 8 attaching holes
- 1805/6: With 12 attaching holes

Type	Dimension L mm	Dimension A mm	Dimension B mm	Dimension G mm	Pack. pcs	Weight kg/100 pcs.	Item No.
1805 2 VA	200	110	51	155	10	54.800	5016 09 6
1805 4 VA	302	212	153	257	20	77.000	5016 11 8
1805 6 VA	404	314	255	359	10	97.100	5016 12 6



V4A Stainless steel, grade 316 Ti

/pc.

1805/...: For connecting different earthing systems

- With 2 mounting holes Ø 11 mm
- 1805/2: With 4 attaching holes
- 1805/4: With 8 attaching holes
- 1805/6: With 12 attaching holes

# Connection material



## Cable bracket for flat conductor

Type	Pack.	Weight	Item No.
	pcs	kg/100 pcs.	
<b>113 BZ-FL</b>	100	6.280	<b>5230 44 6</b>
<b>113 B-Z-HD-FL</b>	100	7.000	<b>5230 46 2</b>

**Zn** Die-cast zinc      **G** Electrogalvanised      /100 pc.

- With female thread M8 or through hole for wood screws
- For flat conductor FL 30
- Sliding over-piece for quick installation

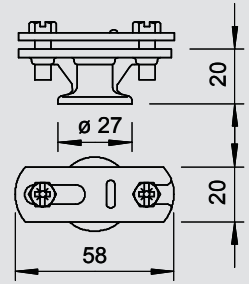

## Cable bracket for Rd 8–10 and FL 30

Type	Fit	Pack.	Weight	Item No.
	mm	pcs	kg/100 pcs.	
<b>835</b>	Rd 8/10/ FL30x3,5	1	12.100	<b>5033 20 9</b>

**St** Steel      **FT** Hot-dip galvanised      /100 pc.

- For round conductor Rd 8-10 and flat conductor FL 30 x 3.5
- Supplied with hexagonal wood bolt 6 x 70 and straddling dowel 910/N

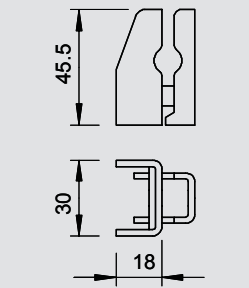

## Spacer clip for flat conductor with fastening hole Ø 6.5

Type	Fit	Dimension B	Pack.	Weight	Item No.
	mm	mm	pcs	kg/100 pcs.	
<b>831 30</b>	max. FL30	54	25	3.580	<b>5032 03 2</b>
<b>831 40</b>	max. FL40	65	25	3.894	<b>5032 04 0</b>

**St** Steel      **FT** Hot-dip galvanised      /100 pc.

- Fit: FL 30 and FL 40
- With mounting hole Ø 6.5 and 2 hexagonal bolts M6 x 16 (F)

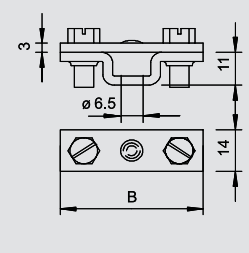

## Spacer clip for flat conductor, with fastening hole Ø 7

Type	Fit	Dimension B	Pack.	Weight	Item No.
	mm	mm	pcs	kg/100 pcs.	
<b>832 30</b>	max. FL30	55	25	7.416	<b>5032 53 9</b>
<b>832 40</b>	max. FL40	65	25	7.612	<b>5032 54 7</b>

**St** Steel      **FT** Hot-dip galvanised      /100 pc.

- Fit: FL 30 and FL 40
- With mounting hole Ø 7 mm and 2 hexagonal bolts M6 x 16

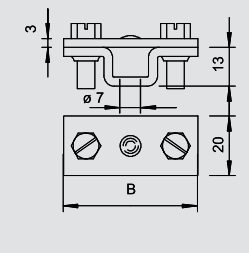

## Spacer clip for flat conductor, with threaded connection M6

Type	Fit	Dimension B	Pack.	Weight	Item No.
	mm	mm	pcs	kg/100 pcs.	
<b>831 30 M6</b>	max. FL30	54	25	3.712	<b>5032 23 7</b>
<b>831 40 M6</b>	max. FL40	65	25	3.880	<b>5032 24 5</b>

**St** Steel      **FT** Hot-dip galvanised      /100 pc.

- Fit: FL 30 and FL 40
- With attaching thread M6 and 2 hexagonal bolts M6 x 16 (F)

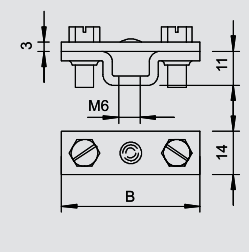

## Spacer clip for flat conductor, with polyamide base

Type	Fit	Dimension B	Pack.	Weight	Item No.
	mm	mm	pcs	kg/100 pcs.	
<b>833 35</b>	max. FL30	60	25	4.228	<b>5033 03 9</b>

**St** Steel      **FT** Hot-dip galvanised      /100 pc.

- Fit: FL 30
- With mounting hole 6.2 x 22 mm
- With 2 cylinder bolts M6 x 16 and over-piece from hot-dip galvanised steel
- Bottom section from polyamide, black

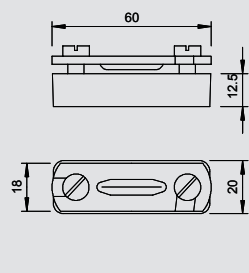

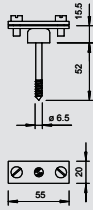

**Spacer clip for flat conductor, with wood screw and spacer**

Type	Fit	Dimension B	Pack.	Weight	Item No.
	mm	mm	pcs	kg/100 pcs.	
<b>370 H</b>	max. FL30	55	100	10.200	<b>5025 20 6</b>

**St** Steel **FT** Hot-dip galvanised /100 pc.

- Fit: FL 30
- With spacer and cylinder bolts M6 x 16 (G)
- With wood bolts

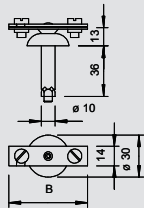

**Spacer clip for flat conductor, with steel spreading anchor Ø 10**

Type	Fit	Dimension B	Pack.	Weight	Item No.
	mm	mm	pcs	kg/100 pcs.	
<b>710 30</b>	max. FL30	52	25	5.044	<b>5028 03 5</b>
<b>710 40</b>	max. FL40	62	25	5.360	<b>5028 04 3</b>

**St** Steel **G** Electrogalvanised /100 pc.

- Fit: FL 30 and FL 40
- With steel straddling dowel Ø 10 mm, spacer and 2 cylinder bolts M5 x 14 (G)

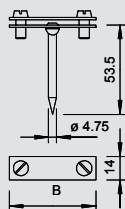

**Spacer clip for flat conductor, with square pin**

Type	Fit	Dimension B	Pack.	Weight	Item No.
	mm	mm	pcs	kg/100 pcs.	
<b>708 30 SP</b>	max. FL30	52	50	3.148	<b>5030 02 1</b>

**St** Steel **G** Electrogalvanised /100 pc.

- Fit: FL 30 and FL 40
- With 2 cylinder bolts M5 x 12 (G) and over-piece
- With square pin

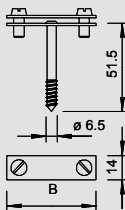

**Spacer clip for flat conductor, with wood screw**

Type	Fit	Dimension B	Pack.	Weight	Item No.
	mm	mm	pcs	kg/100 pcs.	
<b>708 30 HG</b>	max. FL30	52	50	3.148	<b>5030 23 4</b>
<b>708 40 HG</b>	max. FL40	52	50	3.474	<b>5030 24 2</b>

**St** Steel **G** Electrogalvanised /100 pc.

- Fit: FL 30 and FL 40
- With 2 cylinder bolts M5 x 12 (G) and over-piece
- With wood screw



## Holders and accessories



### Plastic corrosion protection strip

Type	Width mm	Length m	Pack. pcs	Weight kg/100 pcs.	Item No.
<b>356 50</b>	50	10	1	71.500	<b>2360 05 5</b>
<b>356 100</b>	100	10	1	122.200	<b>2360 10 1</b>

Petrolatum

/pc.

- Approx. 1.1 mm thick
- Width: 50 mm or 100 mm, made of petrolatum-coated chemical fibre fabric
- Can be processed cold

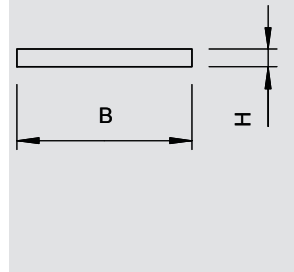

### Strip steel crimp

Type	Length mm	Fit mm	Pack. pcs	Weight kg/100 pcs.	Item No.
<b>366 35</b>	35	max. FL30	100	1.737	<b>5059 35 6</b>
<b>366 50</b>	50	max. FL30	100	2.300	<b>5059 49 6</b>

**St** Steel **FT** Hot-dip galvanised

/100 pc.

- Fit: FL 30

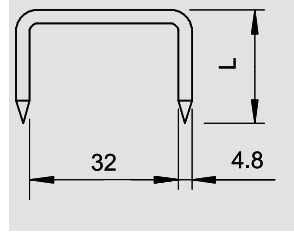

### Number plates

Type	Fit mm	Pack. pcs	Weight kg/100 pcs.	Item No.
<b>311 N-ALU 8-10</b>	RD 8 - 10 / FL30	50	2.500	<b>3049 25 6</b>
<b>311 N-ALU 16</b>	RD 16 - FL30	50	2.800	<b>3049 34 5</b>

**Al** Aluminium

/100 pc.

- To identify the point of separation to DIN 48821
- Suitable for universal labelling (e.g. stamped numbers)

Type	Fit mm	Pack. pcs	Weight kg/100 pcs.	Item No.
<b>311 N-VA 8-10</b>	RD 8 - 10 / FL30	50	5.600	<b>3049 22 1</b>
<b>311 N-VA 16</b>	RD 16 - FL30	50	6.400	<b>3049 32 9</b>

**V2A** Stainless steel, grade 304

/100 pc.

- To identify the point of separation to DIN 48821
- Suitable for universal labelling (e.g. stamped numbers)

Type	Fit mm	Pack. pcs	Weight kg/100 pcs.	Item No.
<b>311 N-CU 8-10</b>	RD 8 - 10 / FL30	50	6.400	<b>3049 20 5</b>
<b>311 N-CU 16</b>	RD 16 - FL30	50	6.800	<b>3049 30 2</b>

**Cu** Copper

/100 pc.

- To identify the point of separation to DIN 48821
- Suitable for universal labelling (e.g. stamped numbers)

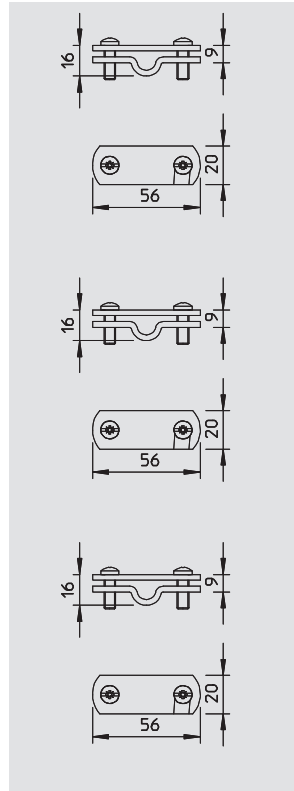

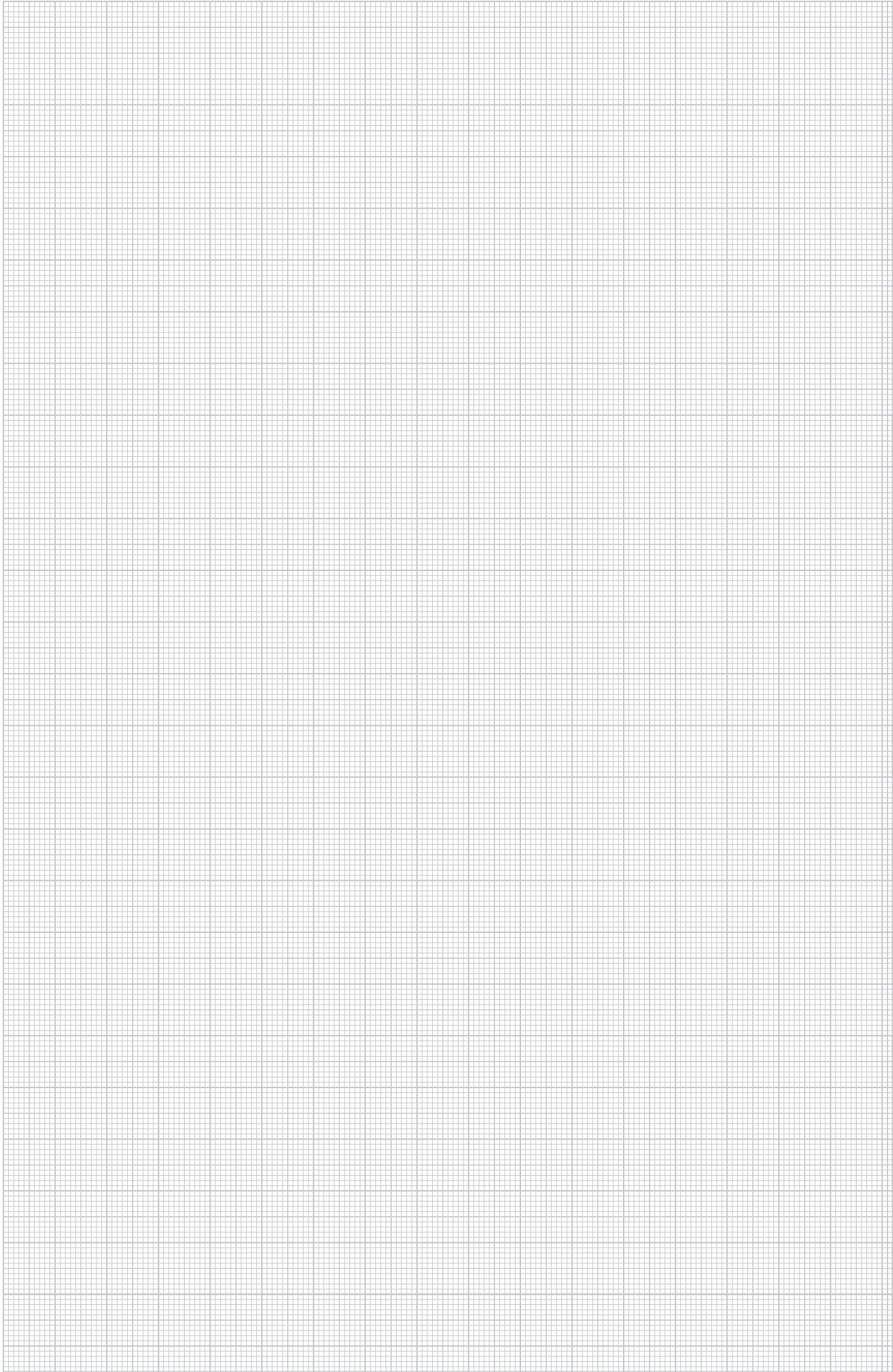













## Interception and arrestor systems

	Cable material	330
	Interception devices	332
	Roof cable holder	337
	Roof cable holder	340
	Cable bracket	347
	Connection and connection terminals	355
	Connection and separating terminals	372
	Earth entries	375
	Accessories	376

# Cable material

## Galvanised steel flat conductor for earth



Type	Dimension b x h mm	Cross- section mm <sup>2</sup>	Normal ring ca. m	Normal ring ca. kg	Weight kg/100 m	Item No.
5052 DIN 20X2.5	20 x 2.5	50	122	50	41.000	5019 34 0
5052 DIN 25X3	25 x 3	75	84	50	59.700	5019 34 2
5052 DIN 30X3	30 x 3	90	71	50	70.650	5019 34 4
5052 DIN 30X3.5	30 x 3.5	105	30	25	84.000	5019 34 5
5052 DIN 30X3.5	30 x 3.5	105	60	50	84.000	5019 34 7
5052 DIN 30X4	30 x 4	120	52	50	97.000	5019 35 0
5052 DIN 40X4	40 x 4	160	40	50	128.000	5019 35 5
5052 DIN 40X5	40 x 5	200	30	50	162.000	5019 36 0

**St** Steel **FT** Hot-dip galvanised /100 m

- According to DIN EN 50164-2 (VDE 0185 Part 202)
- Meets the requirements of VDE 0185-305 (IEC 62305)
- Zinc coating: 500 g/m<sup>2</sup> (approx. 70 µm)
- For lightning protection, earthing systems and ring equipotential bonding

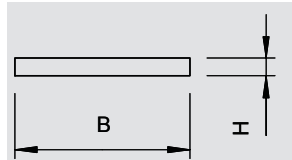

## Stainless steel flat conductor



Type	Dimension b x h mm	Cross- section mm <sup>2</sup>	Normal ring ca. m	Normal ring ca. kg	Weight kg/100 m	Item No.
5052 V2A 30X3.5	30 x 3.5	105	50	42	82.500	5018 50 1
5052 V4A 30X3.5	30 x 3.5	105	50	42	82.425	5018 70 6
5052 V4A 30X3.5	30 x 3.5	105	25	21	82.425	5018 73 0

**V2A** Stainless steel, grade 304 **V4A** Stainless steel, grade 316 Ti /100 m

- According to DIN EN 50164-2 (VDE 0185 Part 202)
- Corresponds to the requirements of VDE 0185-305 (IEC 62305)
- According to the foundation earthing standard DIN 18014, V4A is required in the earth
- For use in areas at risk of corrosion
- For lightning protection, earthing systems and ring equipotential bonding

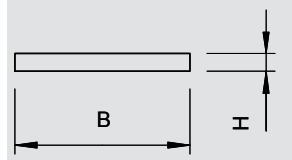

## Flat conductor, copper



Type	Dimension b x h mm	Cross- section mm <sup>2</sup>	Normal ring ca. m	Normal ring ca. kg	Weight kg/100 m	Item No.
FL 20-CU	20 x 2.5	50	45	20	44.500	5021 80 4

**Cu** Copper /100 m

- According to DIN EN 50164-2 (VDE 0185 Part 202)
- Meets the requirements of VDE 0185-305 (IEC 62305)
- Version: E-Cu S7 F24 soft
- For lightning protection, earthing systems and ring equipotential bonding

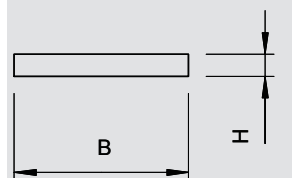

## Round cable, galvanised steel



Type	Nominal size Ø mm	Cross- section mm <sup>2</sup>	Normal ring ca. m	Normal ring ca. kg	Weight kg/100 m	Item No.
RD 8-FT	8	50	125	50	40.000	5021 08 1
RD 10	10	78	80	50	63.000	5021 10 3

**St** Steel **FT** Hot-dip galvanised /100 m

- According to DIN EN 50164-2 (VDE 0185 part 202)
- Conforms to the requirements according to DIN VDE 0185-305 (IEC 62305)
- RD 10 can also be used in earth
- Zinc coating: 350 g/m<sup>2</sup> (approx. 50 µm)

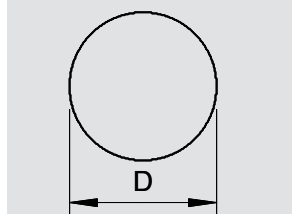

## Round cable, galvanised steel with PVC jacketing



Type	Colour	Dimen- sion d mm	Dimen- sion D mm	Cross- section mm <sup>2</sup>	Normal ring ca. m	Normal ring ca. kg	Weight kg/100 m	Item No.
RD 10-PVC	Black	10	13	78	75	50	67.200	5021 16 2

**St** Steel **FT** Hot-dip galvanised /100 m

- Conforms to the requirements according to VDE V 0185-305, (IEC 62305)
- Zinc coating: 350 g/m<sup>2</sup> (approx. 50 µm)
- With PVC sheathing

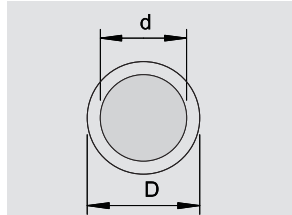

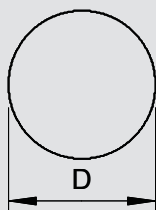

## Round cable, aluminium

Type	Nominal size Ø mm	Cross-section mm <sup>2</sup>	Normal ring ca. m	Normal ring ca. kg	Weight kg/100 m	Item No.
<b>RD 8-ALU</b>	8	50	150	20	13.500	<b>5021 28 6</b>
<b>RD 8-ALU-T</b>	8	50	150	20	13.500	<b>5021 29 4</b>
<b>RD 10-ALU</b>	10	78	95	20	21.000	<b>5021 30 8</b>

**Al** Aluminium

/100 m

- According to DIN EN 50164-2 (VDE 0185 Part 202)
- Meets the requirements of VDE 0185-305 (IEC 62305)
- RD 8/ALU: Semi-hard (E-ALMgSi0.5 corresponds to DIN 48801)
- RD 8/ALU-T: Twistable (E-ALMgSi0.5 corresponds to DIN 48801)
- RD 10/ALU: Pure aluminium (E-Al corresponds to DIN 48801)
- AL and ALMgSi may not be routed directly on, in or under the plaster, mortar or concrete nor underground

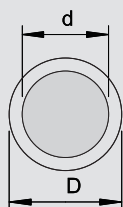

## Round cable, aluminium with PVC sheathing

Type	Colour	Dimen- sion d mm	Dimen- sion D mm	Cross- section mm <sup>2</sup>	Normal ring ca. m	Normal ring ca. kg	Weight kg/100 m	Item No.
<b>RD 8-PVC</b>	Cream	8	11	50	75	15	20.000	<b>5021 33 2</b>

**Al** Aluminium

/100 m

- Meets the requirements of VDE 0185-305 (IEC 62305)
- With PVC jacketing (halogen-free)
- Suitable for routing on, in or under plasterwork, mortar or concrete

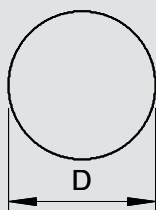

## Round cable, stainless steel

Type	Nominal size Ø mm	Cross-section mm <sup>2</sup>	Normal ring ca. m	Normal ring ca. kg	Weight kg/100 m	Item No.
<b>RD 8-V2A</b>	8	50	125	50	40.000	<b>5021 23 5</b>
<b>RD 10-V2A</b>	10	78	50	32	63.000	<b>5021 22 7</b>
<b>RD 10-V2A</b>	10	78	80	50	63.000	<b>5021 23 9</b>
<b>RD 8-V4A</b>	8	50	125	50	40.000	<b>5021 64 4</b>
<b>RD 10-V4A</b>	10	78	50	32	63.000	<b>5021 64 2</b>
<b>RD 10-V4A</b>	10	78	80	50	63.000	<b>5021 64 7</b>

**V2A** Stainless steel, grade 304 **V4A** Stainless steel, grade 316 Ti

/100 m

- According to DIN EN 50164-2 (VDE 0185 Part 202)
- Corresponds to the requirements of VDE 0185-305 (IEC 62305)
- RD 10-V4A for applications in the earth
- According to the foundation earther standard DIN 18014, V4A is required in the earth

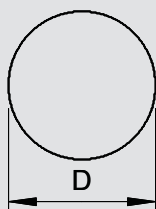

## Round cable, copper

Type	Nominal size Ø mm	Cross-section mm <sup>2</sup>	Normal ring ca. m	Normal ring ca. kg	Weight kg/100 m	Item No.
<b>RD 8-CU</b>	8	50	100	45	45.000	<b>5021 48 0</b>
<b>RD 10-CU</b>	10	78	50	35	70.000	<b>5021 50 2</b>

**Cu** Copper

/100 m

- According to DIN EN 50164-2 (VDE 0185 Part 202)
- Meets the requirements of VDE 0185-305 (IEC 62305)

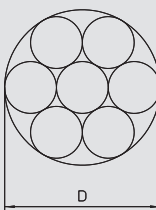

## Copper cable

Type	Dimen- sion D mm	Individual wires	Cross-section mm <sup>2</sup>	Normal ring ca. m	Normal ring ca. kg	Weight kg/100 m	Item No.
<b>S 9-CU</b>	9	7 x Ø3	50	100	44.5	44.500	<b>5021 65 0</b>
<b>S 11-CU</b>	10.5	19 x Ø2.1	70	50	30	58.600	<b>5021 65 4</b>

**Cu** Copper

/100 m

- Conforms to the requirements according to DIN VDE 0185-305 (IEC 62305)
- 7 individual wires of Ø 3 mm (overall cross-section 50 mm<sup>2</sup>)



# Interception system



## Stand for FangFix Junior system

Type	Length mm	Nominal size Ø mm	Pack. pcs	Weight kg/100 pcs.	Item No.
<b>F-FIX-JUNIOR</b>	1,000	10	10	32.000	<b>5403 30 8</b>

**Al** Aluminium

/pc.

- Incl. aluminium interception rod 1,000 mm long (Ø 10 mm)
- Quick mounting of the interception rod in the base using plug technology
- With Vario quick connector 249

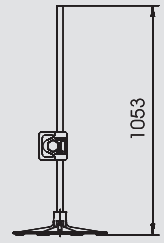

## Interception rod for FangFix-Junior

Type	Length mm	Nominal size Ø mm	Pack. pcs	Weight kg/100 pcs.	Item No.
<b>101 J1000</b>	1,000	10	10	21.800	<b>5401 97 0</b>

**Al** Aluminium

/100 pc.

- Ø 10 mm, Al
- Without thread
- Suitable for use in FangFix Junior

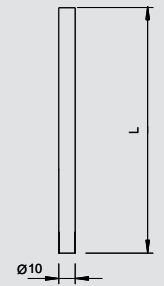

## Base for FangFix Junior

Type	Pack. pcs	Weight kg/100 pcs.	Item No.
<b>F-FIX-BASIS</b>	10	3.790	<b>5403 32 4</b>

**PP** Polypropylene

/pc.

- For mounting Ø 10 mm interception rods up to an overall length of 1,000 mm
- Quick installation of interception rod in base using plug-in system
- Quick and easy installation

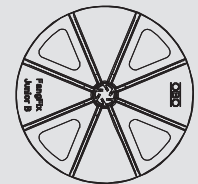
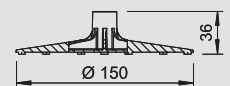

## Interception tip

Type	Fit mm	Pack. pcs	Weight kg/100 pcs.	Item No.
<b>120 A</b>	Rd 8-10	50	2.500	<b>5405 06 8</b>

**Zn** Die-cast zinc

**G** Electrogalvanised

/100 pc.

- To be used for Rd 8-10 (corrosion protection)
- With cylinder bolt M6 x 10
- Made of die-cast zinc, bolts made of hot-galvanised steel

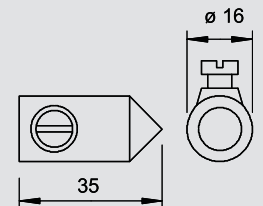

## Tapered pipe interception rod

Type	Length mm	Nominal size Ø mm	Pack. pcs	Weight kg/100 pcs.	Item No.
<b>101 VL1500</b>	1,500	10/16	10	38.000	<b>5401 98 0</b>
<b>101 VL2000</b>	2,000	10/16	10	55.000	<b>5401 98 3</b>
<b>101 VL2500</b>	2,500	10/16	10	72.000	<b>5401 98 6</b>
<b>101 VL3000</b>	3,000	10/16	10	88.000	<b>5401 98 9</b>
<b>101 VL3500</b>	3,500	10/16	10	105.000	<b>5401 99 3</b>
<b>101 VL4000</b>	4,000	10/16	10	120.000	<b>5401 99 5</b>

**Al** Aluminium

/100 pc.

- Suitable for high wind loads
- Final metre tapered from Ø 16 mm to Ø 10 mm
- Suitable for FangFix stand system

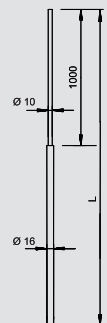

## Interception/earth entry rod, rounded-off on both sides

Type	Length mm	Nominal size Ø mm	Pack. pcs	Weight kg/100 pcs.	Item No.
<b>101 A-1500</b>	1,500	16	10	240.000	<b>5400 15 5</b>

**St** Steel

**FT** Hot-dip galvanised

/100 pc.

- Full material Ø 16 mm
- Rounded on both sides
- Suitable for FangFix stand system

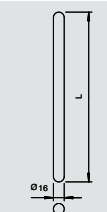

## Interception/earth entry rod, rounded-off on both sides

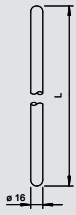

Type	Length mm	Nominal size Ø mm	Pack. pcs	Weight kg/100 pcs.	Item No.
<b>200 V4A-1500</b>	1,500	16	10	242.000	<b>5420 50 4</b>
<b>200 V4A-2000</b>	2,000	16	1	320.000	<b>5420 53 9</b>

**V4A** Stainless steel, grade 316 Ti /100 pc.  
 • Both ends rounded

Type	Length mm	Nominal size Ø mm	Pack. pcs	Weight kg/100 pcs.	Item No.
<b>101 A-CU</b>	1,500	16	10	272.100	<b>5400 62 7</b>

**Cu** Copper /100 pc.  
 • Full material Ø 16 mm  
 • Rounded on both sides  
 • Suitable for FangFix stand system



## Stand for FangFix system 16 kg

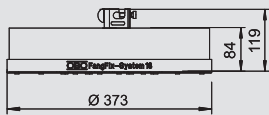

Type	Fit	Nominal size Ø mm	Pack. pcs	Weight kg/100 pcs.	Item No.
<b>F-FIX-16</b>	Rd 8	373	1	1,732.500	<b>5403 20 0</b>
<b>F-FIX-16B</b>	Rd 8	373	54	1,732.500	<b>5403 20 5</b>

- System consists of FangFix stone with base and clamp
- FangFix clamp made of VA; lightning current tested with 100 kA (10/350)
- 16 kg stone of Ø 365 mm, high level of stability
- Quick and easy mounting of interception rod using anchors
- Concrete, frost-resistant
- The FangFix stone can be stacked



## Concrete block for FangFix-System 16 kg

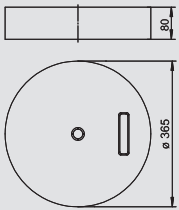

Type	Nominal size Ø mm	Pack. pcs	Weight kg/100 pcs.	Item No.
<b>F-FIX-S16</b>	365	1	1,700.000	<b>5403 22 7</b>

- 16 kg stone of Ø 365 mm, high level of stability
- Concrete, frost-resistant
- Stackable



## Base for FangFix system 16 kg

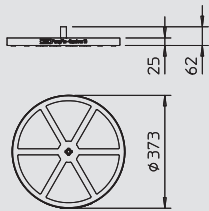

Type	Nominal size Ø mm	Pack. pcs	Weight kg/100 pcs.	Item No.
<b>F-FIX-B16</b>	373	10	12.600	<b>5403 23 5</b>

**PP** Polypropylene /100 pc.  
 Edge protection with integrated dowel (basic) suitable for FangFix system.



## Stand for FangFix system 10 kg

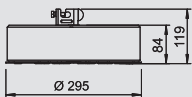

Type	Fit	Nominal size Ø mm	Pack. pcs	Weight kg/100 pcs.	Item No.
<b>F-FIX-10</b>	Rd 8	295	1	1,058.000	<b>5403 10 3</b>
<b>F-FIX-10B</b>	Rd 8	295	72	1,058.000	<b>5403 11 0</b>

- System consists of FangFix stone with base and clamp
- FangFix clamp made of VA; lightning current tested with 100 kA (10/350)
- 10 kg stone of Ø 289 mm, high level of stability
- Quick and easy mounting of interception rod using anchors
- Concrete, frost-resistant
- The FangFix stone can be stacked



# Interception system



## Concrete block for FangFix system 10 kg

Type	Nominal size Ø mm	Pack. pcs	Weight kg/100 pcs.	Item No.
<b>F-FIX-S10</b>	289	1	1,000.000	<b>5403 11 7</b>

/100 pc.

- 10 kg stone of Ø 289 mm, high level of stability
- Concrete, frost-resistant
- Stackable

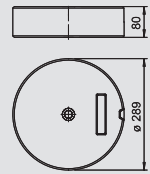

## Base for FangFix system 10 kg

Type	Nominal size Ø mm	Pack. pcs	Weight kg/100 pcs.	Item No.
<b>F-FIX-B10</b>	295	10	5.800	<b>5403 12 4</b>

PP Polypropylene

/100 pc.

Edge protection with integrated dowel (basic) suitable for FangFix 10 system.

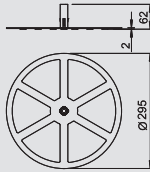

## Terminal for FangFix system

Type	Fit mm	Pack. pcs	Weight kg/100 pcs.	Item No.
<b>F-FIX-KL</b>	Rd 8	5	8.700	<b>5403 21 9</b>

V2A Stainless steel, grade 304

/100 pc.

- FangFix terminal, VA for RD 8 mm
- Tested with H (100 kA) to DIN EN 50164-1
- Round conductor installed on the interception rod with only one screw

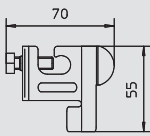

## TrayFix mounting adapter for mesh cable trays on FangFix system

Type	Dimension	Pack. pcs	Weight kg/100 pcs.	Item No.
<b>TrayFix</b>	Ø20mm	25	9.850	<b>5403 10 0</b>

/100 pc.

- Mounting system for fastening mesh cable trays on FangFix blocks of 10 or 16 kg for cable routing on flat roofs.
- Minimum width of the mesh cable tray: 100 mm

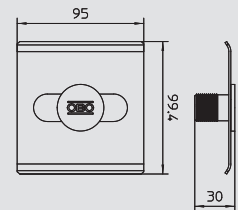

## Interception rod, one end rounded

Type	Length mm	Nominal size Ø mm	Pack. pcs	Weight kg/100 pcs.	Item No.
<b>101 ALU-1000</b>	1,000	16	10	55.000	<b>5401 77 1</b>
<b>101 ALU-1500</b>	1,500	16	10	81.000	<b>5401 80 1</b>
<b>101 ALU-2000</b>	2,000	16	10	109.000	<b>5401 83 6</b>
<b>101 ALU-2500</b>	2,500	16	10	136.000	<b>5401 85 2</b>
<b>101 ALU-3000</b>	3,000	16	5	162.000	<b>5401 87 9</b>

Al Aluminium

/100 pc.

- Ø 16 mm, Al
- For stand system with female thread M16



## Interception rod, one end rounded with connection strap

Type	Length mm	Nominal size Ø mm	Pack. pcs	Weight kg/100 pcs.	Item No.
<b>101 A-L100</b>	1,000	16	10	160.000	<b>5402 80 8</b>
<b>101 A-L150</b>	1,500	16	10	240.000	<b>5402 85 9</b>

St Steel FT Hot-dip galvanised

/100 pc.

- With thread M16 x 20
- With connecting strap
- Including pre-mounted connector type 5001 DIN for round conductor Rd 8-10
- For stands with female thread M16

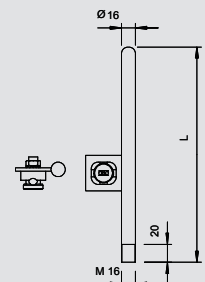

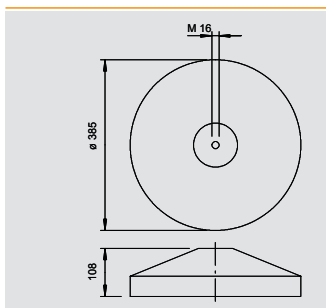

## Stand 16 kg with female thread

Type	Nominal size Ø mm	Thread	Pack. pcs	Weight kg/100 pcs.	Item No.
<b>101 B-16 M16</b>	385	M16	1	1,600.000	<b>5402 95 6</b>

/100 pc.

- Weight 16 kg
- From frost-resistant concrete
- Female thread M16
- Recommended interception rod length max. 3.0 m, depending on wind load zone

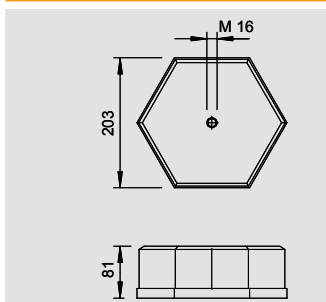

## Stand 6.9 kg with female thread

Type	Thread	Pack. pcs	Weight kg/100 pcs.	Item No.
<b>101 ST</b>	M16	4	690.000	<b>5402 89 1</b>

/100 pc.

- Weight 6.9 kg
- From frost-resistant concrete
- Female thread M16
- Recommended interception rod length max. 1.0 m

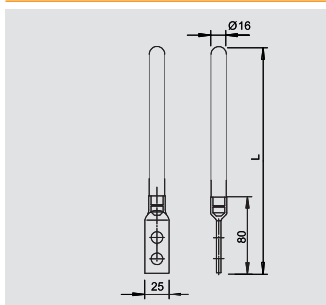

## Interception/earth entry rod with connection tabs

Type	Length mm	Nominal size Ø mm	Pack. pcs	Weight kg/100 pcs.	Item No.
<b>101 F1000</b>	1,000	16	10	160.000	<b>5424 10 0</b>
<b>101 F1500</b>	1,500	16	10	240.000	<b>5424 15 1</b>
<b>101 F2000</b>	2,000	16	10	320.000	<b>5424 20 8</b>

**St** Steel **FT** Hot-dip galvanised

/100 pc.

- With 2 attaching holes Ø 12 mm
- One end rounded

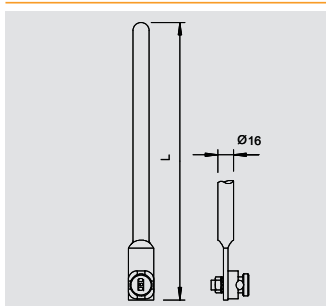

## Interception/earth entry rod with connection tabs and connector

Type	Length mm	Nominal size Ø mm	Pack. pcs	Weight kg/100 pcs.	Item No.
<b>101 G1000</b>	1,000	16	10	164.300	<b>5402 10 7</b>
<b>101 G1500</b>	1,500	16	10	240.000	<b>5402 15 8</b>

**St** Steel **FT** Hot-dip galvanised

/100 pc.

- 1 attaching hole Ø 12 mm
- With pre-mounted conductor for Rd 8-10
- One end rounded

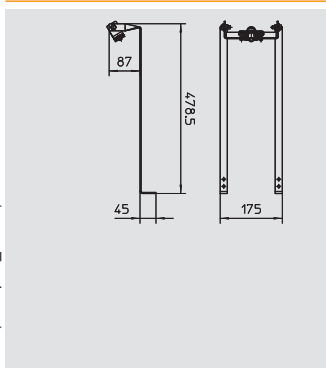

## Interception rod holder for sloping roof

Type	Pack. pcs	Weight kg/100 pcs.	Item No.
<b>SD-Fix</b>	1	81.000	<b>5403 33 5</b>

**V2A** Stainless steel, grade 304

/pc.

Stand system: rod holder for sloping roofs, for simple, quick and secure fastening of Ø 16 mm interception rods.

- System consists of a bracket made of V2A stainless steel
- Quick and easy mounting
- Adjustable angle
- In the case of high interception rods (> 1 m), additional fastening with insulated spaces is necessary



# Interception system



## Interception rod holder for ridge tiles

Type	Dimension L mm	Pack. pcs	Weight kg/100 pcs.	Item No.
<b>F-FIX-132</b>	110	1	62.000	<b>5403 33 0</b>
<b>F-Fix-132-300</b>	300	1	78.000	<b>5403 33 3</b>

**V2A** Stainless steel, grade 304

/pc.

Rod holder for ridge tiles, for simple, quick and safe fastening of Ø 16 mm interception rods

- System consisting of holder made of V2A stainless steel and aluminium interception rod
- Quick and easy mounting thanks to pre-mounted air-termination rod
- Air-termination rod length:
- Air-termination rod length: 1,000 mm
- Width adjustable between 180–260 mm
- Spacing of the ridge holders: 110 mm (5403330)
- Spacing of the ridge holders: 300 mm (5403333)

Application: To protect roof structures such as photovoltaic and TV/SAT systems.

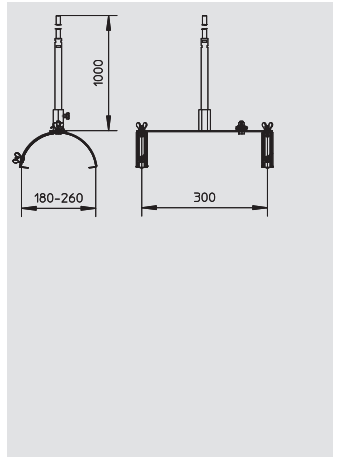

## Mushroom-shaped interceptor with connectors

Type	Fit mm	Dimension D Ø mm	Pack. pcs	Weight kg/100 pcs.	Item No.
<b>128 F</b>	Rd 8-10/ FL30	80	5	40.000	<b>5405 76 9</b>

**St** Steel      **FT** Hot-dip galvanised

/pc.

- Mushroom-shaped interceptor from aluminium
- With pre-mounted cross-piece and hexagonal bolt M8 x 25, hot-dip galvanised steel
- For round conductor Rd 8-10 and flat conductor FL 30

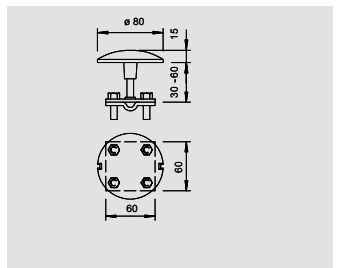

## Roof penetration

Type	Fit mm	Pack. pcs	Weight kg/100 pcs.	Item No.
<b>330 K</b>	Rd 8-10/ FL20 u. FL30	20	14.400	<b>5201 10 1</b>

**PA** Polyamide

/100 pc.

- For round conductor Rd 8-10
- Interception rods Rd 16
- Flat conductor FL 20 and FL 30
- Colour: black

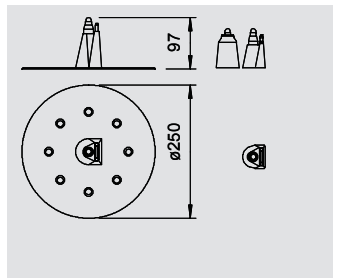



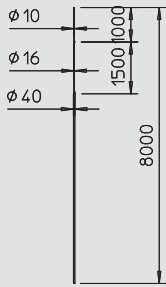

## isFang interception rod

Type	Nominal size Ø	Dimension B	Dimension D	Dimension H	Length	Pack.	Weight	Item No.
	mm	mm	mm	mm	mm	pcs	kg/100 pcs.	
<b>101 3B-4000</b>	40/16/10	2,000	1,000	1,000	4,000	1	400.000	<b>5402 86 4</b>
<b>101 3B-4500</b>	40/16/10	2,500	1,000	1,000	4,500	1	480.000	<b>5402 86 6</b>
<b>101 3B-5000</b>	40/16/10	3,000	1,000	1,000	5,000	1	550.000	<b>5402 86 8</b>
<b>101 3B-5500</b>	40/16/10	3,500	1,000	1,000	5,500	1	630.000	<b>5402 87 0</b>
<b>101 3B-6000</b>	40/16/10	4,000	1,000	1,000	6,000	1	700.000	<b>5402 87 2</b>
<b>101 3B-6500</b>	40/16/10	4,500	1,000	1,000	6,500	1	780.000	<b>5402 87 4</b>
<b>101 3B-7000</b>	40/16/10	5,000	1,000	1,000	7,000	1	850.000	<b>5402 87 6</b>
<b>101 3B-7500</b>	40/16/10	5,500	1,000	1,000	7,500	1	930.000	<b>5402 87 8</b>
<b>101 3B-8000</b>	40/16/10	5,500	1,500	1,000	8,000	1	1,000.000	<b>5402 88 0</b>

**Al** Aluminium

/pc.

Tapered interception rod for isFang tripod stand.

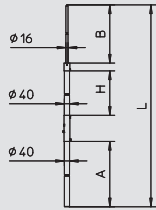

## Insulated interception rod

Type	Dimension D	Dimension A	Dimension H	Dimension B	Length	Materials combination	Pack.	Weight	Item No.
	Ø mm	mm	mm	mm	mm		pcs	kg/100 pcs.	
<b>isFang 4000 AL</b>	40	1,240	1,500	1,000	4,000	Alu / GFK	1	580.000	<b>5408 94 3</b>
<b>isFang 6000 AL</b>	40	3,340	1,500	1,000	6,000	Alu / GFK	1	600.000	<b>5408 94 7</b>
<b>isFang 4000</b>	40	1,240	1,500	1,000	4,000	V2A / GFK	1	680.000	<b>5408 94 2</b>
<b>isFang 6000</b>	40	3,340	1,500	1,000	6,000	V2A / GFK	1	1,260.000	<b>5408 94 6</b>

**GFK** Fibre-glass-reinforced plastic

/pc.

Insulated support pipe for separate installation of interception units and fastening the OBO isCon® cable.

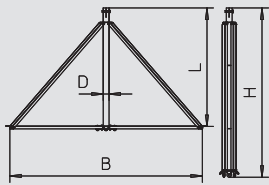

## isFang interception rod stand

Type	Dimension B	Dimension D	Dimension L	Dimension H	Pack.	Weight	Item No.
	mm	Ø mm	mm	mm	pcs	kg/100 pcs.	
<b>isFang 3B-100 AL</b>	1,000	40	600	885	1	380.000	<b>5408 96 6</b>
<b>isFang 3B-150 AL</b>	1,500	40	900	1,275	1	560.000	<b>5408 96 7</b>
<b>isFang 3B-100</b>	1,000	40	600	885	1	620.000	<b>5408 96 8</b>
<b>isFang 3B-150</b>	1,500	40	900	1,275	1	950.000	<b>5408 96 9</b>

**V2A** Stainless steel, grade 304 **Al** Aluminium

/pc.

Folding tripod stand for screwless installation of free-standing interception rods with a diameter of 40 mm, e.g. for OBO isCon® cable. Roof slope to max. 5 degrees. Incl. Rd 8–10 crossbar for rapid round conductor fastening. The concrete plinth and threaded rods are to be ordered separately.

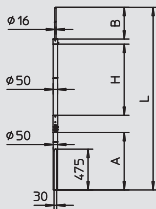

## Insulated interception rod for inner-routed isCon cable with side exit

Type	Dimension D	Dimension A	Dimension H	Dimension B	Length	Materials combination	Pack.	Weight	Item No.
	Ø mm	mm	mm	mm	mm		pcs	kg/100 pcs.	
<b>isFang IN-A 4000</b>	50	1,325	1,500	1,000	4,000	Alu / GFK	1	535.000	<b>5408 93 8</b>
<b>isFang IN-A 6000</b>	50	3,325	1,500	1,000	6,000	Alu / GFK	1	835.000	<b>5408 94 0</b>

**GFK** Fibre-glass-reinforced plastic

/pc.

- For installation of the OBO isCon® cable in the pipe
- With side cable outlet, fitting tripod stand type isFang 3B-A
- Inclusive connection element (type isCon IN connect)
- Inclusive potential connection (type isCon IN PAE)

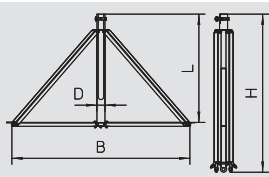

## isFang interception rod stand with side exit

Type	Dimension B	Dimension D	Dimension L	Dimension H	Pack.	Weight	Item No.
	mm	Ø mm	mm	mm	pcs	kg/100 pcs.	
<b>isFang 3B-100-A</b>	1,026	50	600	885	1	6,100.000	<b>5408 93 0</b>
<b>isFang 3B-150-A</b>	1,500	50	900	1,275	1	950.000	<b>5408 93 2</b>

**V2A** Stainless steel, grade 304

/pc.

- Screwless installation of freestanding interception rods as well as insulated interception rods with 50 mm diameter
- e.g. for internal OBO isCon® cable
- Roof slope to max. 5 degrees
- Incl. Rd 8–10 crossbar for quick round conductor fastening
- Concrete plinths as well as threaded rods should be ordered separately



# Interception rod systems



## isFang-3B threaded rod

Type	Dimension L mm	Pack. pcs	Weight kg/100 pcs.	Item No.
<b>isFang 3B-G1</b>	270	3	48.000	<b>5408 97 1</b>
<b>isFang 3B-G2</b>	340	3	60.400	<b>5408 97 2</b>
<b>isFang 3B-G3</b>	430	3	76.600	<b>5408 97 3</b>

V2A Stainless steel, grade 304

/pc.

Threaded rod to fasten 1, 2 or 3 FangFix concrete bases with tripod stand. To mount the threaded rods, the edge protection must be drilled.

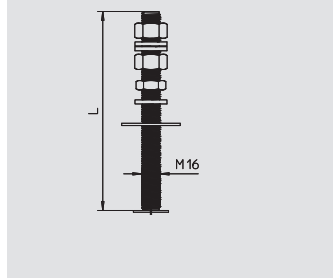

## Concrete block for FangFix-System 16 kg

Type	Nominal size Ø mm	Pack. pcs	Weight kg/100 pcs.	Item No.
<b>F-FIX-S16</b>	365	1	1,700.000	<b>5403 22 7</b>

/100 pc.

- 16 kg stone of Ø 365 mm, high level of stability
- Concrete, frost-resistant
- Stackable

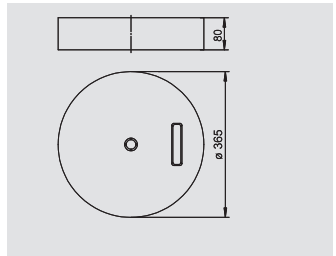

## Base for FangFix system 16 kg for mounting the isFang tripod

Type	Nominal size Ø mm	Dimension D mm	Pack. pcs	Weight kg/100 pcs.	Item No.
<b>F-FIX-B16 3B</b>	373	25	10		<b>5403 23 8</b>

PP Polypropylene

- Edge protection with through hole
- For mounting isFang-3B threaded rod and FangFix concrete block F-FIX-S16

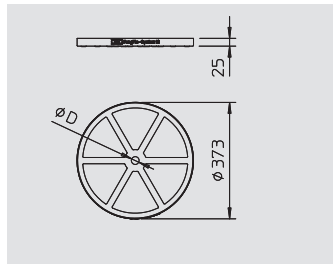

## Insulated interception rod for inner-routed isCon cable

Type	Dimension D Ø mm	Dimension A mm	Dimension H mm	Dimension B mm	Dimension L mm	Length mm	Materials combination	Pack. pcs	Weight kg/100 pcs.	Item No.
<b>isFang IN 4000</b>	50	1,325	1,500	1,000	4,000	4,000	Alu / GFK	1	535.000	<b>5408 93 4</b>
<b>isFang IN 6000</b>	50	3,325	1,500	1,000	6,000	6,000	Alu / GFK	1	835.000	<b>5408 93 6</b>

GFK Fibre-glass-reinforced plastic

/pc.

- For installation of the OBO isCon® cable in the pipe
- For mounting on the building structure
- Inclusive connection element (type isCon IN connect)
- Inclusive potential connection (type isCon In PAE)

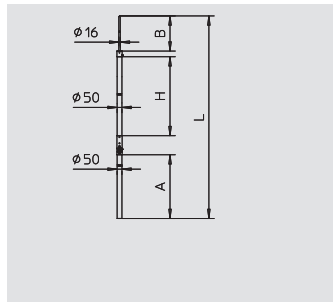

## isFang support for wall mounting, 15 mm spacing

Type	Dimension D Ø mm	Dimension L mm	Pack. pcs	Weight kg/100 pcs.	Item No.
<b>isFang TW30</b>	—	30	2	62.000	<b>5408 95 2</b>

V2A Stainless steel, grade 304

/pc.

Fastening clip to fasten the insulated support pipes on the structure to be protected or on the wall.

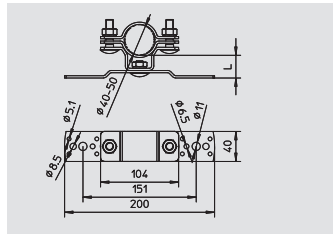

## isFang support for wall mounting, 80 mm spacing

Type	Dimension D Ø mm	Dimension L mm	Pack. pcs	Weight kg/100 pcs.	Item No.
<b>isFang TW80</b>	—	80	2	63.000	<b>5408 95 0</b>

V2A Stainless steel, grade 304

/pc.

Fastening clip to fasten the insulated support pipes on the structure to be protected or on the wall.

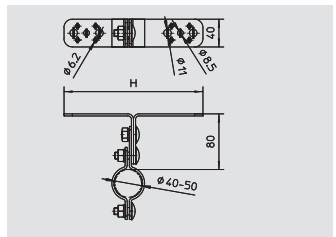

## isFang support for wall mounting, 200–300 mm spacing

Type	Dimension D Ø mm	Dimension L mm	Pack. pcs	Weight kg/100 pcs.	Item No.
<b>isFang TW200</b>	—	300	2	230.000	<b>5408 95 4</b>

V2A Stainless steel, grade 304

/pc.

Fastening clip to fasten the insulated support pipes on the structure to be protected or on the wall.

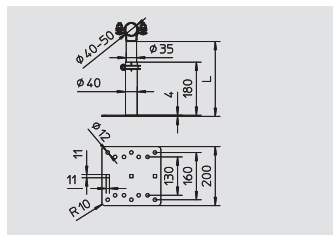

## isFang support for pipe mounting, $\varnothing$ 50–300 mm

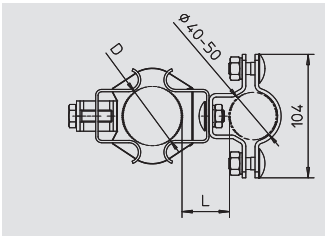

Type	Dimension D $\varnothing$ mm	Dimension L mm	Pack. pcs	Weight kg/100 pcs.	Item No.
<b>isFang TR100</b>	300	40	2	77.000	<b>5408 95 6</b>

V2A Stainless steel, grade 304 /pc.  
Tightening strap clip to fasten the insulated support pipes on the structure to be protected or for construction-side pipes of  $\varnothing$  50–300mm.

## isFang support for spaced pipe mounting, $\varnothing$ 50–300 mm

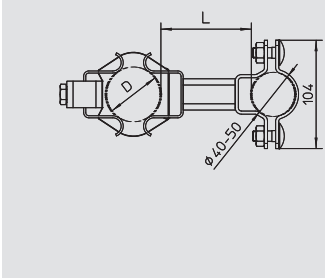

Type	Dimension D $\varnothing$ mm	Dimension L mm	Pack. pcs	Weight kg/100 pcs.	Item No.
<b>isFang TR100 100</b>	300	100	2	95.500	<b>5408 95 5</b>
<b>isFang TR100 200</b>	300	200	2	121.000	<b>5408 95 7</b>
<b>isFang TR100 300</b>	300	300	2	146.000	<b>5408 95 9</b>

V2A Stainless steel, grade 304 /pc.  
Tightening strap clip to fasten the insulated support pipes on the structure to be protected or for construction-side pipes of  $\varnothing$  50–300mm.

## isFang support for pipe mounting, $\varnothing$ 40–50 mm

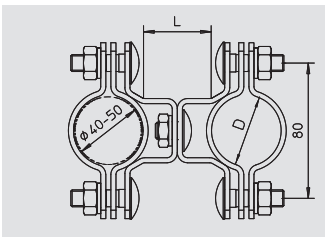

Type	Dimension D $\varnothing$ mm	Dimension L mm	Pack. pcs	Weight kg/100 pcs.	Item No.
<b>isFang TS40-50</b>	50	40	2	90.000	<b>5408 95 8</b>

V2A Stainless steel, grade 304 /pc.  
Fastening clip to fasten the insulated support pipes on the structure to be protected or for construction-side pipes of  $\varnothing$  40–50mm.

## isFang support for pipe mounting, $\varnothing$ 50–60 mm

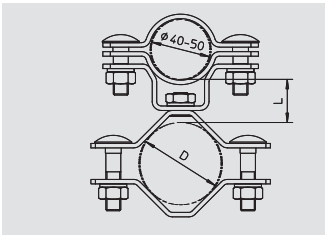

Type	Dimension D $\varnothing$ mm	Dimension L mm	Pack. pcs	Weight kg/100 pcs.	Item No.
<b>isFang TS50-60</b>	60	30	2	76.000	<b>5408 96 0</b>

V2A Stainless steel, grade 304 /pc.  
Fastening clip to fasten the insulated support pipes on the structure to be protected or for construction-side pipes of  $\varnothing$  50–60mm.

## isFang support for corner pipe mounting, 50 x 50 mm

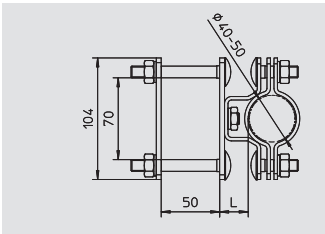

Type	Dimension D $\varnothing$ mm	Dimension L mm	Pack. pcs	Weight kg/100 pcs.	Item No.
<b>isFang TS50x50</b>	–	30	2	82.000	<b>5408 96 4</b>

V2A Stainless steel, grade 304 /pc.  
Fastening clip to fasten the insulated support pipes on the structure to be protected or for construction-side corner pipes of 50x50mm.



# Roof cable holder

## Ridge conductor holder with tensioning spring



Type	Fit	Installation height	Pack.	Weight	Item No.
	mm	mm	pcs	kg/100 pcs.	
<b>132 U 35</b>	Rd 8	35	20	6.800	<b>5203 01 8</b>
<b>V2A</b> Stainless steel, grade 304 • For round conductor Rd 8 • Clamping range 280-380 mm					/100 pc.
<b>132 U</b>	Rd 8	20	20	6.000	<b>5203 01 5</b>
<b>V2A</b> Stainless steel, grade 304 • For round conductor Rd 8 • Clamping range 280-380 mm					/100 pc.
<b>132 U-CU</b>	Rd 8	20	20	0.600	<b>5203 02 3</b>
<b>V2A</b> Stainless steel, grade 304 <span style="background-color: #e67e22; color: white; padding: 2px;">Cu</span> Copper-plated					/100 pc.
• For round conductor Rd 8 • Clamping range 280-380 mm					

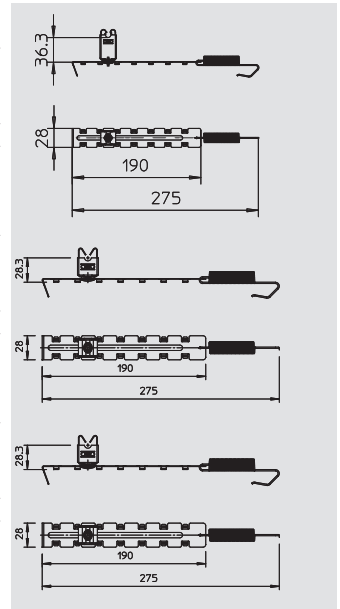

## Roof cable holder for ridge tiles, 185–260 mm, Rd 8



Type	Fit	Installation height	Pack.	Weight	Item No.
	mm	mm	pcs	kg/100 pcs.	
<b>132 VA 35</b>	Rd 8	35	50	13.700	<b>5202 83 6</b>
<b>V2A</b> Stainless steel, grade 304 • Adjustable width from 185-260 mm • Fast installation using wing screw					/100 pc.
<b>132 VA</b>	Rd 8	20	50	12.900	<b>5202 83 3</b>
<b>V2A</b> Stainless steel, grade 304 • Adjustable width from 185-260 mm • Fast installation using wing screw					/100 pc.
<b>132 CU</b>	Rd 8	20	50	13.400	<b>5202 86 8</b>
<span style="background-color: #e67e22; color: white; padding: 2px;">Cu</span> Copper • Adjustable width from 185-260 mm • Fast installation using wing screw					/100 pc.

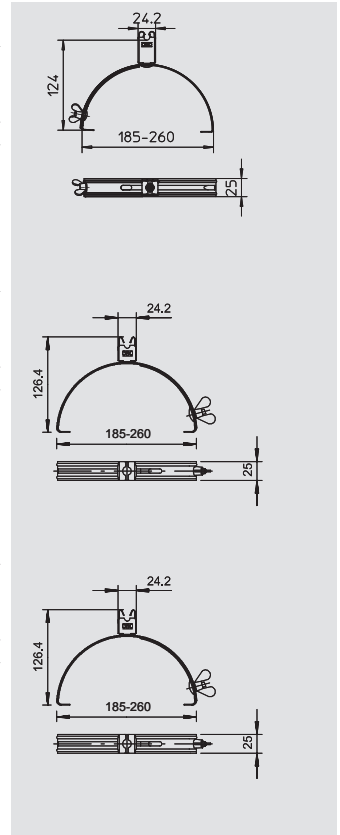

## Roof cable holder for ridge tiles, 185–260 mm, Rd 8–10



Type	Fit	Installation height	Pack.	Weight	Item No.
	mm	mm	pcs	kg/100 pcs.	
<b>132 K-VA</b>	Rd 8-10	20	50	10.900	<b>5202 51 5</b>
<b>V2A</b> Stainless steel, grade 304 • Adjustable width from 185-260 mm • Bottom part made of non-rusting stainless steel (V2A) • Infinitely adjustable conductor holder • Conductor holder of polyamide • Fast installation using wing screw					/100 pc.

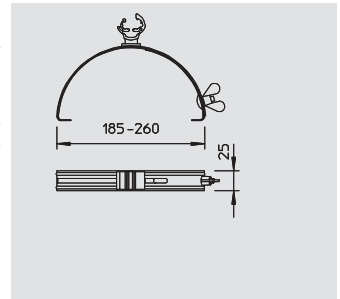

## Roof cable holder for ridge tiles, 185–260 mm, Rd 8–10

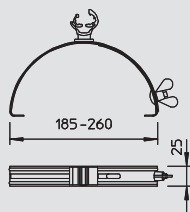

Type	Fit	Installation height	Pack.	Weight	Item No.
	mm	mm	pcs	kg/100 pcs.	
<b>132 K-CU</b>	Rd 8-10	20	50	11.600	<b>5202 59 0</b>

**Cu** Copper

- Adjustable width from 185-260 mm
- Bottom part made of copper
- Infinitely adjustable conductor holder
- Conductor holder of polyamide
- Fast installation using wing screw

/100 pc.



## Roof cable holder for ridge tiles, 180–240 mm, Rd 8–10

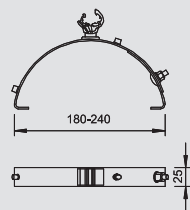

Type	Fit	Installation height	Pack.	Weight	Item No.
	mm	mm	pcs	kg/100 pcs.	
<b>132 N-DK</b>	Rd 8-10	20	50	19.700	<b>5202 56 6</b>

**St** Steel **FT** Hot-dip galvanised

- Adjustable from 180–240 mm
- With conductor 177/20, polyamide, grey
- With 3 M8 threaded nipples for positioning the holder

/100 pc.



## Roof cable holder for ridge tiles with M8 threaded bolts

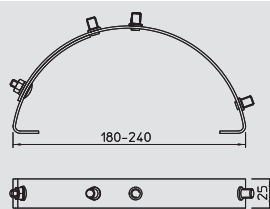

Type	Fit	Installation height	Pack.	Weight	Item No.
	mm	mm	pcs	kg/100 pcs.	
<b>132 GB-M8</b>			50	18.700	<b>5202 56 8</b>

**St** Steel **FT** Hot-dip galvanised

- Adjustable from 180–240 mm
- With conductor 177/20, polyamide, grey
- With 3 M8 threaded nipples for positioning the holder

/100 pc.



## Roof cable holder for tiled roofs, Rd 8

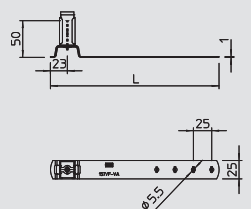

Type	Fit	Installation height	Length	Pack.	Weight	Item No.
	mm	mm	mm	pcs	kg/100 pcs.	
<b>157 F-VA 230 35</b>	Rd 8	50	230	50	8.300	<b>5215 55 5</b>
<b>157 F-VA 280 35</b>	Rd 8	50	280	50	9.700	<b>5215 58 2</b>
<b>157 F-VA 410 35</b>	Rd 8	50	410	50	11.800	<b>5215 59 8</b>

**V2A** Stainless steel, grade 304

- Conductor holder from stainless steel (V2A)
- Including drill hole in bottom section for quick installation

/100 pc.

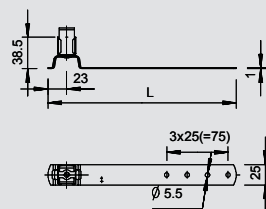

Type	Fit	Installation height	Length	Pack.	Weight	Item No.
	mm	mm	mm	pcs	kg/100 pcs.	
<b>157 F-VA 230</b>	Rd 8	38.5	230	50	8.350	<b>5215 55 2</b>
<b>157 F-VA 280</b>	Rd 8	38.5	280	50	10.170	<b>5215 57 9</b>
<b>157 F-VA 410</b>	Rd 8	38.5	410	50	14.880	<b>5215 59 5</b>

**V2A** Stainless steel, grade 304

- Conductor holder from stainless steel (V2A)
- Including drill hole in bottom section for quick installation

/100 pc.

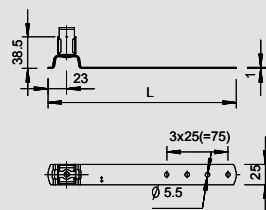

Type	Fit	Installation height	Length	Pack.	Weight	Item No.
	mm	mm	mm	pcs	kg/100 pcs.	
<b>157 F-CU 230</b>	Rd 8	38.5	230	50	10.300	<b>5216 19 2</b>
<b>157 F-CU 280</b>	Rd 8	38.5	280	50	11.100	<b>5216 20 6</b>
<b>157 F-CU 410</b>	Rd 8	38.5	410	50	14.500	<b>5216 25 7</b>

**Cu** Copper

- Conductor holder from copper plated stainless steel (V2A)
- Including drill hole in bottom section for quick installation

/100 pc.



## Roof cable holder for tiled roofs, Rd 8–10

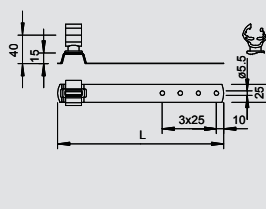

Type	Fit	Installation height	Length	Pack.	Weight	Item No.
	mm	mm	mm	pcs	kg/100 pcs.	
<b>157 FK-VA 230</b>	Rd 8-10	40	230	50	7.800	<b>5215 54 4</b>
<b>157 FK-VA 280</b>	Rd 8-10	40	280	50	10.170	<b>5215 58 7</b>
<b>157 FK-VA 410</b>	Rd 8-10	40	410	50	14.880	<b>5215 60 9</b>

**V2A** Stainless steel, grade 304

- Conductor holder of polyamide
- Including drill hole in bottom section for quick installation

/100 pc.



# Roof cable holder



## Roof cable holder for tiled roofs, Rd 8–10

Type	Fit	Installation height	Length	Pack.	Weight	Item No.
	mm	mm	mm	pcs	kg/100 pcs.	
<b>157 FK-CU 230</b>	Rd 8-10	40	230	50	8.800	<b>5215 18 4</b>
<b>157 FK-CU 280</b>	Rd 8-10	40	280	50	9.600	<b>5215 21 4</b>
<b>157 FK-CU 410</b>	Rd 8-10	40	410	50	13.000	<b>5215 26 5</b>

**Cu** Copper

/100 pc.

- Conductor holder of polyamide
- Including drill hole in bottom section for quick installation

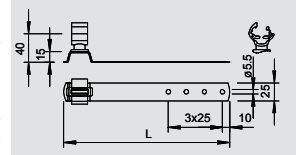

## Roof cable holder for tiled roofs, angled, Rd 8

Type	Fit	Installation height	Length	Pack.	Weight	Item No.
	mm	mm	mm	pcs	kg/100 pcs.	
<b>157 I-VA</b>	Rd 8	26.5	140	50	7.150	<b>5215 62 5</b>

**V2A** Stainless steel, grade 304

/100 pc.

- Conductor holder high-grade stainless steel (V2A)
- Curved bottom strip for quick installation



Type	Fit	Installation height	Length	Pack.	Weight	Item No.
	mm	mm	mm	pcs	kg/100 pcs.	
<b>157 I-CU</b>	Rd 8	26.5	140	50	7.800	<b>5215 74 9</b>

**Cu** Copper

/100 pc.

- Conductor holder copper plated high-grade stainless steel (V2A)
- Curved bottom strip for quick installation

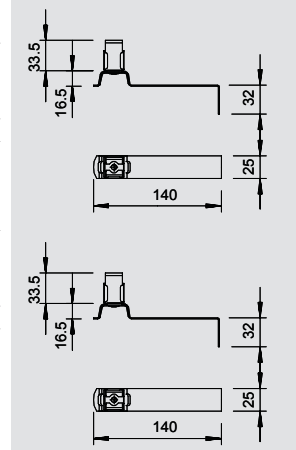

## Roof cable holder for tiled roofs, angled, flexible, Rd 8

Type	Fit	Installation height	Length	Pack.	Weight	Item No.
	mm	mm	mm	pcs	kg/100 pcs.	
<b>157 FX-AL</b>	Rd 8	26.5	140	50	3.900	<b>5215 87 5</b>

**Al** Aluminium

/100 pc.

- With flexible bottom section from aluminium for matching to roof tiles (easy to flex)
- Holder from stainless steel (V2A)
- Curved bottom section for quick installation



Type	Fit	Installation height	Length	Pack.	Weight	Item No.
	mm	mm	mm	pcs	kg/100 pcs.	
<b>157 FX-CU</b>	Rd 8	26.5	140	50	7.500	<b>5215 87 9</b>

**Cu** Copper

/100 pc.

- With flexible bottom section from copper for matching to roof tiles (easy to flex)
- Holder from copper plated stainless steel (V2A)
- Curved bottom section for quick installation

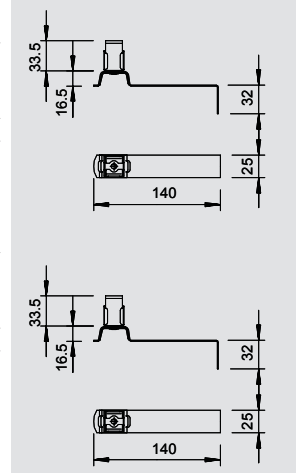

## Roof cable holder for tiled roofs, angled, Rd 8–10

Type	Fit	Installation height	Length	Pack.	Weight	Item No.
	mm	mm	mm	pcs	kg/100 pcs.	
<b>157 IK-VA</b>	Rd 8-10	40	140	50	7.150	<b>5215 66 8</b>

**V2A** Stainless steel, grade 304

/100 pc.

- Conductor holder of polyamide
- Curved bottom strip for quick installation

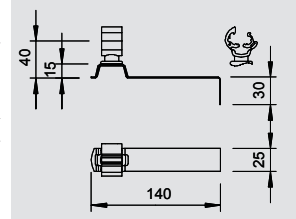

## Roof cable holder for slated roofs, crimped, Rd 8

Type	Fit	Length	Installation height	Pack.	Weight	Item No.
	mm	mm	mm	pcs	kg/100 pcs.	
<b>157 E-VA 35</b>	Rd 8	265	50	50	8.800	<b>5215 50 4</b>

**V2A** Stainless steel, grade 304

/100 pc.

- Conductor holder from stainless steel (V2A)
- With Ø 5.5 mm drill hole



Type	Fit	Length	Installation height	Pack.	Weight	Item No.
	mm	mm	mm	pcs	kg/100 pcs.	
<b>157 E-VA</b>	Rd 8	265	38.5	50	9.050	<b>5215 50 1</b>

**V2A** Stainless steel, grade 304

/100 pc.

- Conductor holder from stainless steel (V2A)
- With Ø 5.5 mm drill hole

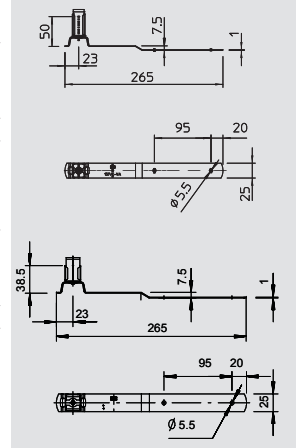

## Roof cable holder for slated roofs, crimped, Rd 8

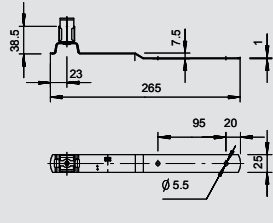

Type	Fit	Length	Installation height	Pack.	Weight	Item No.
	mm	mm	mm	pcs	kg/100 pcs.	
<b>157 E-CU</b>	Rd 8	265	38.5	50	9.050	<b>5215 80 3</b>

- Cu** Copper /100 pc.
- Conductor holder from copper plated stainless steel (V2A).
  - With Ø 5.5 mm drill hole



## Roof cable holder for slated roofs, crimped, Rd 8-10

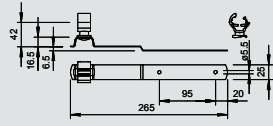

Type	Fit	Length	Installation height	Pack.	Weight	Item No.
	mm	mm	mm	pcs	kg/100 pcs.	
<b>157 EK-VA</b>	Rd 8-10	265	42	50	7.800	<b>5215 83 8</b>

- V2A** Stainless steel, grade 304 /100 pc.
- Conductor holder of polyamide
  - With Ø 5.5 mm drill hole

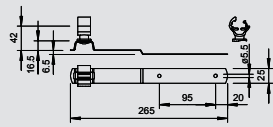

Type	Fit	Length	Installation height	Pack.	Weight	Item No.
	mm	mm	mm	pcs	kg/100 pcs.	
<b>157 EK-CU</b>	Rd 8-10	265	42	50	8.800	<b>5215 85 4</b>

- Cu** Copper /100 pc.
- Conductor holder of polyamide
  - With Ø 5.5 mm drill hole



## Roof cable holder for slated roofs, Rd 8

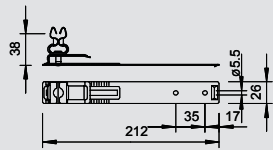

Type	Fit	Length	Installation height	Pack.	Weight	Item No.
	mm	mm	mm	pcs	kg/100 pcs.	
<b>157 L-VA</b>	Rd 8	212	32	50	8.000	<b>5215 43 9</b>

- V2A** Stainless steel, grade 304 /100 pc.
- With Ø 5.5 mm drill hole and beading

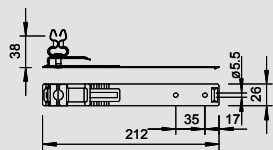

Type	Fit	Length	Installation height	Pack.	Weight	Item No.
	mm	mm	mm	pcs	kg/100 pcs.	
<b>157 L-CU</b>	Rd 8	212	32	50	9.900	<b>5215 47 1</b>

- Cu** Copper /100 pc.
- With Ø 5.5 mm drill hole and beading



## Roof cable holder for slated roofs, Rd 8-10

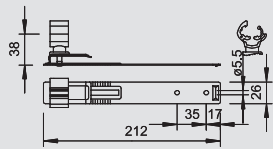

Type	Fit	Length	Installation height	Pack.	Weight	Item No.
	mm	mm	mm	pcs	kg/100 pcs.	
<b>157 LK-VA</b>	Rd 8-10	212	38	50	8.000	<b>5215 37 4</b>

- V2A** Stainless steel, grade 304 /100 pc.
- With Ø 5.5 mm drill hole and beading
  - Conductor holder of polyamide

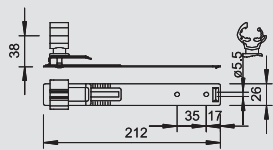

Type	Fit	Length	Installation height	Pack.	Weight	Item No.
	mm	mm	mm	pcs	kg/100 pcs.	
<b>157 LK-CU</b>	Rd 8-10	212	38	50	8.400	<b>5215 38 2</b>

- Cu** Copper /100 pc.
- With Ø 5.5 mm drill hole and beading
  - Conductor holder of polyamide



## Roof cable holder for tiled and slated roofs, Rd 8-10

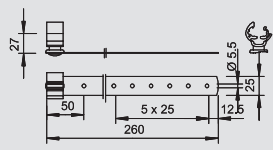

Type	Fit	Length	Installation height	Pack.	Weight	Item No.
	mm	mm	mm	pcs	kg/100 pcs.	
<b>157 NB-VA</b>	Rd 8-10	260	27	100	6.000	<b>5215 27 7</b>

- V2A** Stainless steel, grade 304 /100 pc.
- With Ø 5.5 mm drill hole
  - Conductor holder of polyamide



# Roof cable holder



## Roof cable holder for tiled and slated roofs, 74 mm height

Type	Fit	Length	Installation height	Pack.	Weight	Item No.
	mm	mm	mm	pcs	kg/100 pcs.	
<b>157 ND-VA</b>	Rd 8-10	260	74	100	17.060	<b>5215 30 7</b>

V2A Stainless steel, grade 304

- High roof cable holder: 74 mm
- With perforation Ø 5.5 mm
- Polyamide cable bracket

/100 pc.

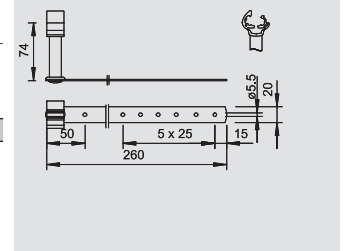

## Roof cable holder for slated roofs with M8 threaded bolts

Type	Fit	Length	Installation height	Pack.	Weight	Item No.
	mm	mm	mm	pcs	kg/100 pcs.	
<b>157 GB-M8</b>	-	260	-	100	5.000	<b>5202 56 9</b>

V2A Stainless steel, grade 304

- With Ø 5.5 mm drill hole
- With 3 M8 threaded nipples for positioning the holder

/100 pc.

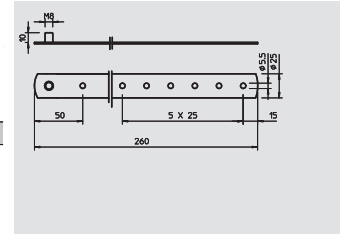

## Roof cable holder for tiled, slated and corrugated roofs, with crossbar

Type	Fit	Installation height	Pack.	Weight	Item No.
	mm	mm	pcs	kg/100 pcs.	
<b>133 A</b>	Rd 8-10	50	50	9.000	<b>5202 24 8</b>

PA Polyamide

- With weatherproof clamping collar from soft PVC
- Required drill hole-Ø = 16 mm
- Spacer from polyamide, grey

/100 pc.

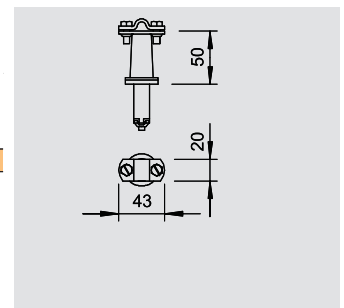

## Roof cable holder for tiled, slated and corrugated roofs, with cable bracket

Type	Fit	Installation height	Pack.	Weight	Item No.
	mm	mm	pcs	kg/100 pcs.	
<b>133 NB</b>	Rd 8-10	67	50	8.000	<b>5202 21 3</b>

PA Polyamide

- With weather-proof clamping collar from soft-PVC
- Required drill hole-Ø = 16 mm
- Spacer and conductor holder from polyamide, grey

/100 pc.

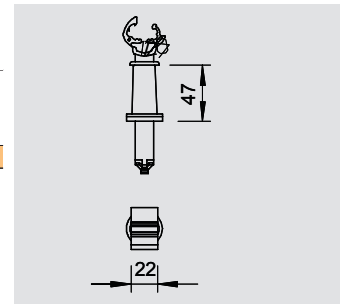

## Roof cable holder for tiled, slated and corrugated roofs, Rd 8

Type	Fit	Installation height	Pack.	Weight	Item No.
	mm	mm	pcs	kg/100 pcs.	
<b>159 VA-V</b>	Rd 8	21	50	3.900	<b>5217 07 5</b>

V2A Stainless steel, grade 304

- Bottom section and conductor holder stainless steel (V2A)
- Bottom section with Ø 8.5 mm slot

/100 pc.

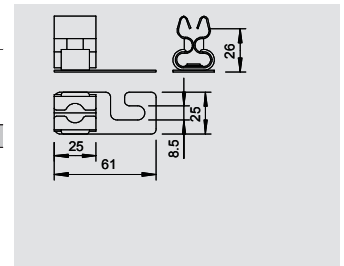

## Roof cable holder for tiled, slated and corrugated roofs, Rd 8-10

Type	Fit	Installation height	Pack.	Weight	Item No.
	mm	mm	pcs	kg/100 pcs.	
<b>159 K-VA</b>	Rd 8-10	21	50	2.540	<b>5216 81 8</b>

V2A Stainless steel, grade 304

- Bottom section stainless steel (V2A)
- Bottom section with Ø 8.5 mm slot
- Conductor holder of polyamide

/100 pc.

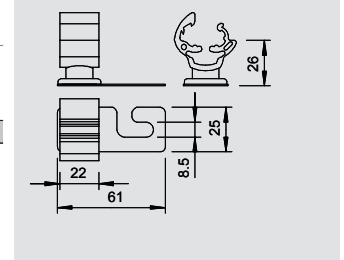



## Roof cable holder for flat roofs

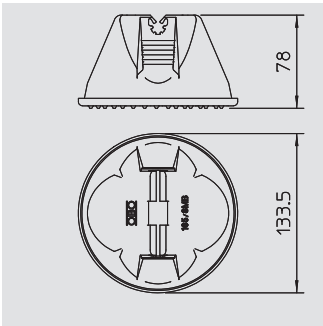

Type	Fit	Pack.	Weight	Item No.
	mm	pcs	kg/100 pcs.	
<b>165 MBG-8</b>	Rd 8	12	106.000	<b>5218 69 1</b>
<b>165 MBG-10</b>	Rd 10	12	106.000	<b>5218 67 5</b>

PA/PE Polyamide/Polyethylene

/100 pc.

- DIN 48829 Form B 1
- Closed form with bottom
- With double conductor holder
- Filling weight 1 kg (frost-resistant concrete)
- Sleeve from polyethylene, black, bottom polypropylene, black



## Roof cable holder for flat roofs, with increased base section

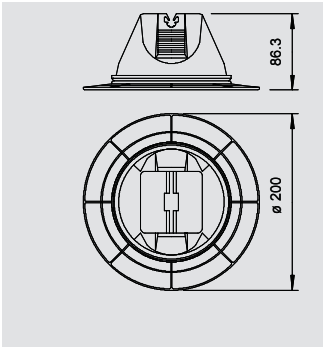

Type	Fit	Pack.	Weight	Item No.
	mm	pcs	kg/100 pcs.	
<b>165 MBG-8 200</b>	Rd 8	12	111.000	<b>5218 74 8</b>
<b>165 MBG-10 200</b>	Rd 10	12	111.000	<b>5218 75 6</b>

PE Polyethylene

/100 pc.

- DIN 48829 Form B 1
- Closed form with bottom
- With double conductor holder
- Filling weight 1 kg (frost-resistant concrete)
- Sleeve from polyethylene, black, bottom polypropylene, black
- With larger bottom section (Ø 200 mm) for improved stability



## Roof cable holder for flat roofs, without base

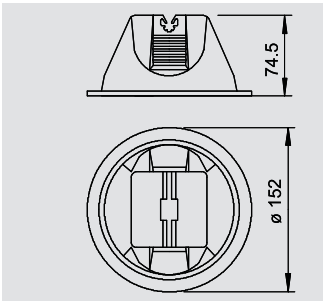

Type	Fit	Pack.	Weight	Item No.
	mm	pcs	kg/100 pcs.	
<b>165 OBG-8</b>	Rd 8	12	100.000	<b>5218 68 3</b>

PE Polyethylene

/100 pc.

- Without bottom
- With double conductor holder
- Filling weight 1 kg (frost-resistant concrete)
- Sleeve from polyethylene, black



## Flat conductor adapter for roof cable holder, type 165/MBG

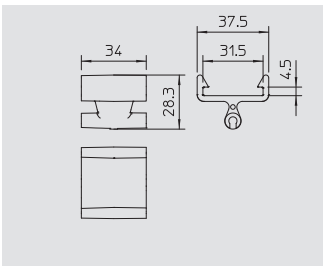

Type	Colour	Fit	Pack.	Weight	Item No.
		mm	pcs	kg/100 pcs.	
<b>165 MBG HFL</b>	Black	Rd 8	12	0.670	<b>5218 88 5</b>

PP Polypropylene

/100 pc.

- Flat conductor holder FL 30 x 3.5 mm
- For fastening to 165/MBG in fit Rd 8



## Universal adapter for roof cable holder, type 165/MBG

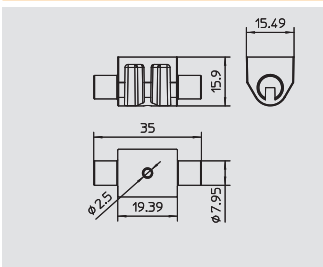

Type	Colour	Fit	Pack.	Weight	Item No.
		mm	pcs	kg/100 pcs.	
<b>165 MBG UH</b>	Black	Rd 8	25	0.280	<b>5218 88 2</b>

PP Polypropylene

/pc.

Universal adapter with drillhole Ø 2.5 mm e.g. for OBO Golden Sprint screw, type 4758 4 x L (L = depending on application), for fastening to 165/MBG.



## Roof cable holder for flat roofs, plastic sleeve

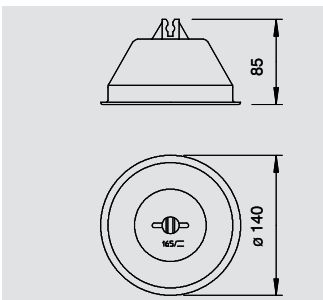

Type	Fit	Pack.	Weight	Item No.
	mm	pcs	kg/100 pcs.	
<b>165 KR</b>	Rd 8	50	5.300	<b>5218 86 1</b>

PE Polyethylene

/100 pc.

- For self-filling with concrete
- Potential filling weight: approx. 1.3 kg
- Sleeve from polyethylene, black



# Roof cable holder



## Roof cable holder for flat roofs, with raised cable bracket

Type	Fit	Pack.	Weight	Item No.
	mm	pcs	kg/100 pcs.	
<b>165 KRB SO</b>	Rd 8-10	9	144.000	<b>5218 97 7</b>

/100 pc.

- For self-filling with concrete
- Potential filling weight: approx. 1.3 kg
- Sleeve from polyethylene, black

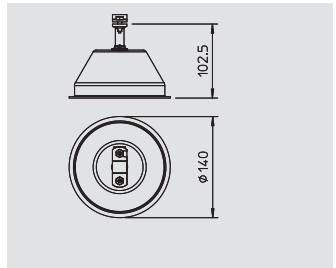

## Roof cable holder for flat roofs, recyclable

Type	Fit	Pack.	Weight	Item No.
	mm	pcs	kg/100 pcs.	
<b>165 R-8-10</b>	Rd 8-10	10	106.000	<b>5218 99 7</b>

**PE** Polyethylene

/100 pc.

165/R-8-10: Roof conductor holder for flat roofs

- For round conductor Rd 8 to 10
- With plastic mount, polyethylene, black
- Stone from frost-resistant concrete
- Weight 1 kg
- Stone separable into plastic and concrete (recyclable)

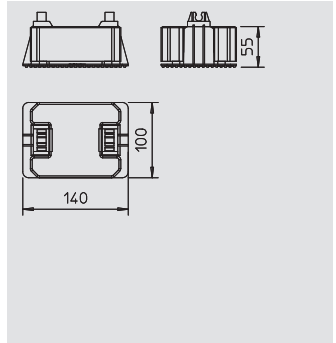

## Roof cable holder, suitable for bonding straight to flat roofs

Type	Fit	Installation height	Pack.	Weight	Item No.
	mm	mm	pcs	kg/100 pcs.	
<b>165 B 60</b>	Rd 8-10	60	50	26.100	<b>5218 81 0</b>
<b>165 B 100</b>	Rd 8-10	100	50	27.700	<b>5218 82 9</b>

**St** Steel

**FT** Hot-dip galvanised

/100 pc.

- With conductor holder and bottom section, hot-dip galvanised steel
- Bottom section Ø 100 mm

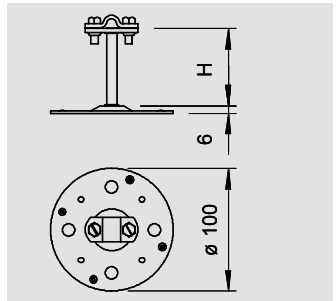

## Roof cable holder, 55 mm, suitable for bonding straight to flat roofs

Type	Fit	Length	Pack.	Weight	Item No.
	mm	mm	pcs	kg/100 pcs.	
<b>165 NBK 55</b>	Rd 8-10	55	75	17.060	<b>5218 31 4</b>

**PA** Polyamide

/100 pc.

- Suitable for bonding straight to flat roofs
- Conductor holder of polyamide
- Bottom section, hot-dip galvanised steel
- Bottom section Ø 100 mm

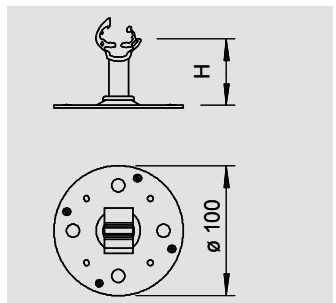

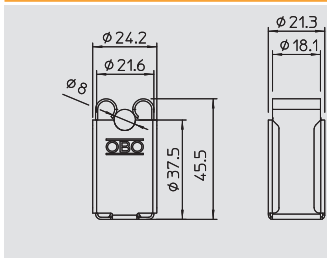

**Screwless cable bracket, raised construction type, for Rd 8 mm, through-way Ø 5 mm**

Type	Fit	Installation height	Pack.	Weight	Item No.
	mm	mm	pcs	kg/100 pcs.	
<b>177 35 VA M6</b>	Rd 8	35	50	2.680	<b>5207 34 2</b>

V2A Stainless steel, grade 304 /100 pc.

- With female thread M6 or through hole Ø 5 mm
- Made of rustproof stainless steel (V2A)

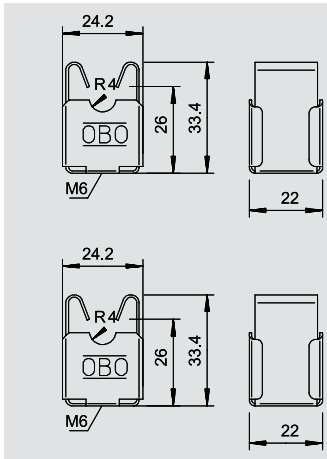

**Screwless cable bracket for Rd 8 mm, through-way Ø 5 mm**

Type	Fit	Installation height	Pack.	Weight	Item No.
	mm	mm	pcs	kg/100 pcs.	
<b>177 20 VA M6</b>	Rd 8	20	50	2.500	<b>5207 33 9</b>

V2A Stainless steel, grade 304 /100 pc.

- With female thread M6 or through hole Ø 5 mm
- From stainless steel (V2A)



Type	Fit	Installation height	Pack.	Weight	Item No.
	mm	mm	pcs	kg/100 pcs.	
<b>177 20 VA-VK M6</b>	Rd 8	20	50	2.500	<b>5207 80 0</b>

V2A Stainless steel, grade 304 Cu Copper-plated /100 pc.

- With female thread M6 or through hole Ø 5 mm
- From stainless steel (V2A)
- Version -VK: copper-plated

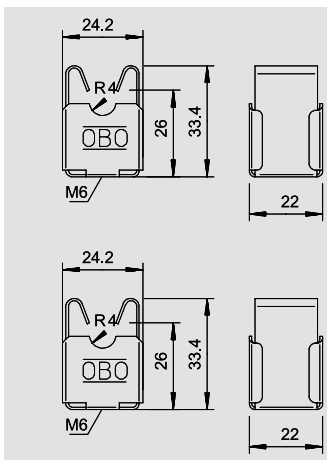

**Screwless cable bracket for Rd 8 mm, through-way Ø 7 mm**

Type	Fit	Installation height	Pack.	Weight	Item No.
	mm	mm	pcs	kg/100 pcs.	
<b>177 20 VA M8</b>	Rd 8	20	50	1.900	<b>5207 34 7</b>

V2A Stainless steel, grade 304 /100 pc.

- With female thread M8 or through hole Ø 5 mm
- From stainless steel (V2A)



Type	Fit	Installation height	Pack.	Weight	Item No.
	mm	mm	pcs	kg/100 pcs.	
<b>177 20 VA-VK M8</b>	Rd 8	20	50	1.900	<b>5207 81 9</b>

V2A Stainless steel, grade 304 Cu Copper-plated /100 pc.

- With female thread M8 or through hole Ø 5 mm
- From stainless steel (V2A)

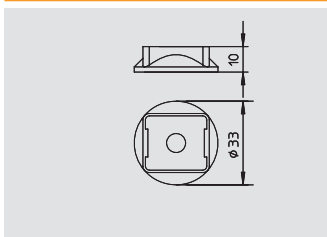

**Washer for cable bracket, type 177**

Type	Colour	Pack.	Weight	Item No.
		pcs	kg/100 pcs.	
<b>177 U</b>	Light grey	50	0.295	<b>5207 37 1</b>

PP Polypropylene /100 pc.

- For simple wall installation
- UV-resistant

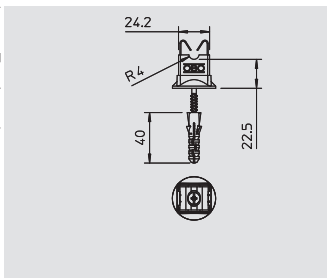

**Screwless cable bracket for Rd 8 mm, fastening with screw and anchor**

Type	Fit	Installation height	Pack.	Weight	Item No.
	mm	mm	pcs	kg/100 pcs.	
<b>177 20 VA B-HD</b>	Rd 8	20	100	2.900	<b>5207 90 1</b>

V2A Stainless steel, grade 304

- With female thread M8 or through hole Ø 5 mm
- From stainless steel (V2A)
- With pre-mounted wood screws (5 x 60) and plastic dowels (8 x 40).



# Cable bracket

## Universal cable bracket Rd 8–10 mm



Type	Fit	Installation height	Pack.	Weight	Item No.
	mm	mm	pcs	kg/100 pcs.	
<b>177 20 M8</b>	Rd 8-10	20	50	1.050	<b>5207 44 4</b>
<b>177 30 M8</b>	Rd 8-10	30	50	1.200	<b>5207 46 0</b>
<b>177 55 M8</b>	Rd 8-10	55	50	1.450	<b>5207 48 7</b>

**PA** Polyamide

/100 pc.

- With female thread M8 or through hole  $\varnothing$  7 mm
- Weather and temperature-resistant from -35 °C to +90 °C

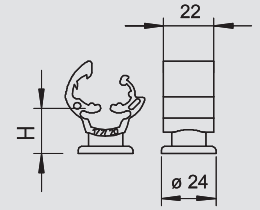

## Universal cable bracket Rd 8–10 mm, copper-plated



Type	Fit	Installation height	Pack.	Weight	Item No.
	mm	mm	pcs	kg/100 pcs.	
<b>177 20 CU</b>	Rd 8-10	20	50	1.050	<b>5207 74 6</b>
<b>177 30 CU</b>	Rd 8-10	30	50	1.200	<b>5207 75 4</b>
<b>177 55 CU</b>	Rd 8-10	55	50	1.450	<b>5207 76 2</b>

**PA** Polyamide

/100 pc.

- With female thread M8 for screwing and through hole for wood screws
- Colour: copper
- Weather and temperature-resistant from -35 °C to +90 °C

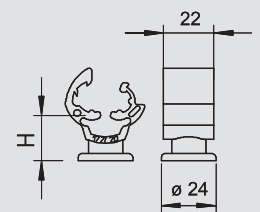

## Universal cable bracket Rd 8–10 mm with pre-mounted wood screw



Type	Fit	Installation height	Pack.	Weight	Item No.
	mm	mm	pcs	kg/100 pcs.	
<b>177 B-HD20</b>	Rd 8-10	20	100	1.930	<b>5207 85 1</b>
<b>177 B-HD30</b>	Rd 8-10	30	100	2.080	<b>5207 87 8</b>

**PA** Polyamide

/100 pc.

- With female thread M8 for screwing and through hole for wood screws
- For round conductor Rd 8-10
- Weather and temperature-resistant from -35 °C to +90 °C
- With pre-mounted wood screws (5 x 60) and plastic dowels (8 x 40).

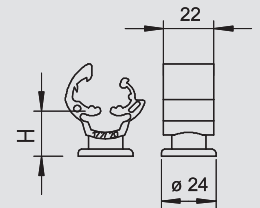

## Bonding base



Type	Colour	Thread	Pack.	Weight	Item No.
			pcs	kg/100 pcs.	
<b>194</b>	Grey	M8	100	0.548	<b>5207 25 8</b>

**PA** Polyamide

/100 pc.

- With threaded stem M8
- For mounting conductor supports with M8 female thread
- For bonding to concrete, steel or brickwork

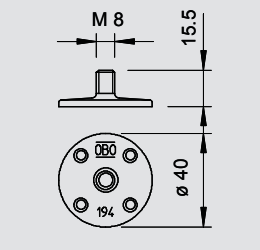

## Bonding base including industrial bonding pad



Type	Colour	Thread	Pack.	Weight	Item No.
			pcs	kg/100 pcs.	
<b>194 K</b>	Grey	M8	100	0.600	<b>5207 26 6</b>

**PA** Polyamide

/100 pc.

- With threaded pin M8
- To accept cable supports with M8 internal thread
- For bonding to concrete, steel or smooth substrates
- Not suitable for rough surfaces such as plaster, wood, bitumen strips
- Processing at > +15 °C and on cleaned substrate
- To route the arrester, cannot be used on the roof
- Use on sheet roofs after agreement with the responsible roofing contractors

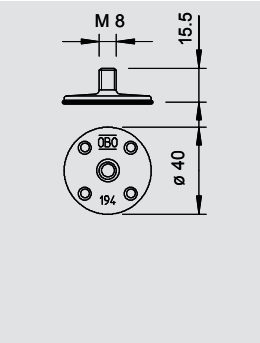

## Cable bracket, Rd 8–10 mm with bonding base



Type	Pack.	Weight	Item No.
	pcs	kg/100 pcs.	
<b>177 20 KL</b>	100	1.650	<b>5207 45 1</b>

**PA** Polyamide

/100 pc.

- For bonding to concrete, steel or smooth substrates
- Not suitable for rough surfaces such as plaster, wood, bitumen strips
- Processing at > +15 °C and on cleaned substrate
- To route the arrester, cannot be used on the roof
- Use on sheet roofs after agreement with the responsible roofing contractors

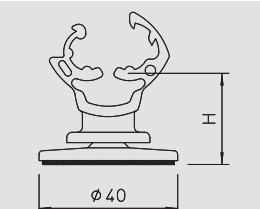

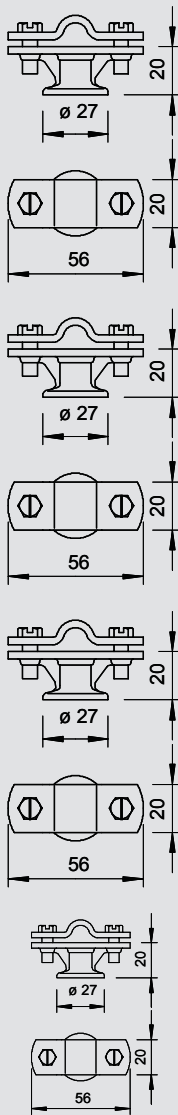

**Cable bracket with crossbar Rd 8–10 mm**

Type	Fit	Pack.	Weight	Item No.
	mm	pcs	kg/100 pcs.	
<b>113 Z8-10</b>	Rd 8-10	50	6.202	<b>5229 96 0</b>

- Zn** Die-cast zinc      **G** Electrogalvanised      /100 pc.
- With female thread M8 or through hole Ø 7 mm
  - Over-piece installed with 2 hexagonal bolts
  - Version HD with wood screws (5 x 60) and plastic dowels (8 x 40)



Type	Fit	Pack.	Weight	Item No.
	mm	pcs	kg/100 pcs.	
<b>113 B-Z-HD</b>	Rd 8-10	100	6.580	<b>5230 32 2</b>

- Zn** Die-cast zinc      **VZ** Galvanised      /100 pc.
- With female thread M8 or through hole Ø 7 mm
  - Over-piece installed with 2 hexagonal bolts
  - Version HD with wood screws (5 x 60) and plastic dowels (8 x 40)



Type	Fit	Pack.	Weight	Item No.
	mm	pcs	kg/100 pcs.	
<b>113 8-10</b>	Rd 8-10	50	9.600	<b>5230 21 7</b>

- Zn** Die-cast zinc      **Cu** Copper-plated      /100 pc.
- With female thread M8 or through hole Ø 7 mm
  - Over-piece installed with 2 hexagonal bolts



Type	Fit	Pack.	Weight	Item No.
	mm	pcs	kg/100 pcs.	
<b>113 B-MS-HD 8-10</b>	Rd 8-10	100	7.280	<b>5230 36 5</b>

- Zn** Die-cast zinc      **Cu** Copper-plated      /100 pc.
- With female thread M8 or through hole Ø 7 mm
  - Over-piece installed with 2 hexagonal bolts
  - Version HD with wood screws (5 x 60) and plastic dowels (8 x 40)



**Cable bracket with hinged crossbar Rd 8–10 mm**

Type	Fit	Pack.	Weight	Item No.
	mm	pcs	kg/100 pcs.	
<b>113 Z-K 8-10</b>	Rd 8-10	50	6.202	<b>5229 96 1</b>

- Zn** Die-cast zinc      **G** Electrogalvanised      /100 pc.
- With female thread M8 or through hole Ø 7 mm
  - Hinge crossbar for quick swivel mounting
  - Crossbar mounted with 2 hexagonal bolts



**Cable bracket with hinged crossbar Rd 8–10, 30 mm mounting height**

Type	Fit	Thread	Pack.	Weight	Item No.
	mm		pcs	kg/100 pcs.	
<b>168 8-10 M6</b>	Rd 8-10	M6	50	7.800	<b>5229 16 2</b>
<b>168 DIN-K-M8</b>	Rd 8-10	M8	50	7.780	<b>5229 83 9</b>

- Zn** Die-cast zinc      **G** Electrogalvanised      /100 pc.
- With female thread (G)
  - With over-piece and 2 hexagonal bolts
  - Installed height 30 mm



Interception and arrester systems



02\_TBS\_Masterkatalog\_Länder\_2012 / en / 29/05/2012 (LLEExport\_014333) / 29/05/2012

# Cable bracket



## Cable bracket with hinged crossbar Rd 8–10, 30 mm mounting height

Type	Fit	Thread	Pack.	Weight	Item No.
	mm		pcs	kg/100 pcs.	
<b>168 ZN-M6</b>	Rd 8-10	M6	50	8.660	<b>5229 36 7</b>
<b>168 DIN-K-M8</b>	Rd 8-10	M8	50	8.440	<b>5229 38 3</b>

**Zn** Die-cast zinc      **Cu** Copper-plated      /100 pc.

- With female thread (G)
- With over-piece and 2 hexagonal bolts
- Installed height 30 mm

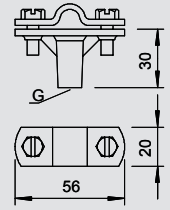

## Cable bracket with crossbar FL, 30 mm mounting height

Type	Dimension B	Fit	Thread	Pack.	Weight	Item No.
	mm	mm		pcs	kg/100 pcs.	
<b>168 FL40-M8</b>	66	FL 40	M8	50	8.200	<b>5229 55 3</b>

**TG** Cast iron      **FT** Hot-dip galvanised      /100 pc.

- For flat strip
- With female thread (G)
- Installed height 30 mm



Type	Dimension B	Fit	Thread	Pack.	Weight	Item No.
	mm	mm		pcs	kg/100 pcs.	
<b>168 FL30-M6</b>	56	FL 30	M6	50	7.640	<b>5229 46 4</b>
<b>168 DIN 30</b>	56	FL 30	M8	50	7.320	<b>5229 48 0</b>

**Zn** Die-cast zinc      **G** Electrogalvanised      **VZ** Galvanised      /100 pc.

- For flat strip
- With female thread (G)
- Installed height 30 mm

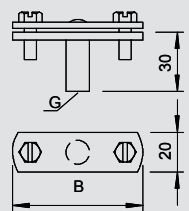
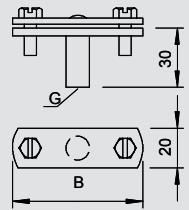

## Cable bracket with crossbar Rd 8–10 mm, with square pin

Type	Fit	Length	Pack.	Weight	Item No.
	mm	mm	pcs	kg/100 pcs.	
<b>163 70 FT</b>	Rd 8-10	70	50	8.476	<b>5223 07 5</b>
<b>163 100 FT</b>	Rd 8-10	100	50	10.056	<b>5223 10 5</b>
<b>163 150 FT</b>	Rd 8-10	150	50	14.400	<b>5223 15 6</b>
<b>163 200 FT</b>	Rd 8-10	200	20	18.880	<b>5223 20 2</b>

**St** Steel      **FT** Hot-dip galvanised      /100 pc.

- Complete with over-piece and hexagonal bolts
- With square pin for quick installation
- With hexagonal bolts, VA



Type	Fit	Length	Pack.	Weight	Item No.
	mm	mm	pcs	kg/100 pcs.	
<b>163 100 CU</b>	Rd 8-10	100	50	10.840	<b>5223 60 1</b>

**Cu** Copper      /100 pc.

- Complete with over-piece and hexagonal bolts
- With square pin for quick installation
- With hexagonal bolts, VA

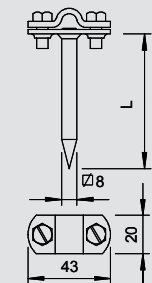
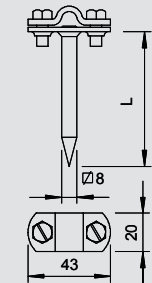

## Cable bracket with crossbar FL 30 mm, with round pin

Type	Fit	Length	Pack.	Weight	Item No.
	mm	mm	pcs	kg/100 pcs.	
<b>166 LS 70</b>	FL30	70	50	9.140	<b>5226 57 0</b>

**St** Steel      **FT** Hot-dip galvanised      /100 pc.

- With over-piece and 2 hex-head screws (VA)
- Round pin Ø 9 mm

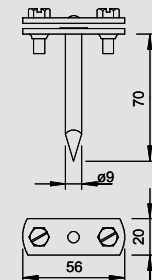

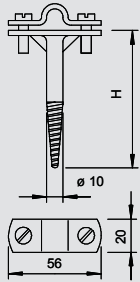

**Cable bracket with crossbar Rd 8–10 mm, with wood screw thread**

Type	Fit	Dimension H	Pack.	Weight	Item No.
	mm	mm	pcs	kg/100 pcs.	
176 A 65	Rd 8-10	65	50	9.536	5227 07 0
176 A 80	Rd 8-10	80	50	10.025	5227 08 9
176 A 100	Rd 8-10	100	50	11.500	5227 10 0
176 A 150	Rd 8-10	150	20	13.100	5227 15 1

TG Cast iron F Hot-dip galvanised /100 pc.

- Also for flat conductor to FL 30
- With wood screw thread
- Bottom section, hot-dip galvanised cast iron
- Over-piece and screws, hot dipped galvanised steel

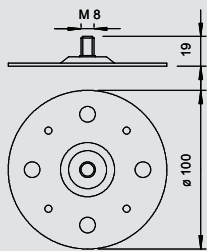

**Base plate**

Type	Thread	Pack.	Weight	Item No.
		pcs	kg/100 pcs.	
199 DIN	M8	100	14.200	5208 01 7

St Steel FS Strip-galvanised /100 pc.

- With threaded pin M8
- Suitable for direct bonding
- Threaded pin brass and base plate hot-dip galvanised steel

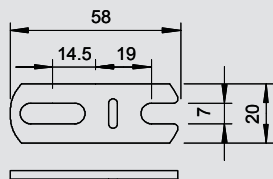

**Hinge crossbar for FL 30 mm**

Type	Fit	Pack.	Weight	Item No.
	mm	pcs	kg/100 pcs.	
156 FL	FL30	100	2.460	5228 32 8

St Steel FT Hot-dip galvanised /100 pc.

- With slot for quick installation

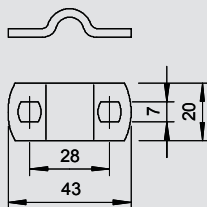

**Crossbar for Rd 8–10 mm**

Type	Fit	Pack.	Weight	Item No.
	mm	pcs	kg/100 pcs.	
156 K8-10 ST	Rd 8-10	100	2.000	5228 12 3

St Steel FT Hot-dip galvanised /100 pc.

- For round conductor Rd 8-10

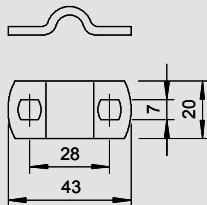

Type	Fit	Pack.	Weight	Item No.
	mm	pcs	kg/100 pcs.	
156 K8-10 VA	Rd 8-10	100	2.100	5228 13 4

V2A Stainless steel, grade 304 /100 pc.

- For round conductor Rd 8-10

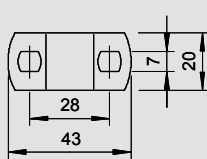

Type	Fit	Pack.	Weight	Item No.
	mm	pcs	kg/100 pcs.	
156 K8-10 CU	Rd 8-10	100	2.260	5228 13 1

Cu Copper /100 pc.

- For round conductor Rd 8-10

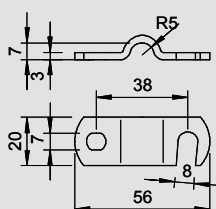

**Hinge crossbar for Rd 8-10 mm**

Type	Fit	Pack.	Weight	Item No.
	mm	pcs	kg/100 pcs.	
156 8-10	Rd 8-10	100	2.680	5228 02 6

St Steel FT Hot-dip galvanised /100 pc.

- With open slot for quick installation



02\_TBS\_Masterkatalog\_Länder\_2012 / en / 29/05/2012 (LLEExport\_01433) / 29/05/2012

Interception and arrester systems

# Cable bracket

## Clamping block for Rd 8-10 mm

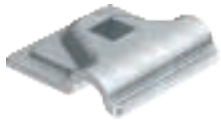

Type	Fit	Dimension A	Pack.	Weight	Item No.
	mm	mm	pcs	kg/100 pcs.	
<b>249 8-10 ST-OT</b>	Rd 8-10	40	100	3.240	<b>5311 50 3</b>

**St** Steel **FT** Hot-dip galvanised /100 pc.

- For round cable fastening RD 8-10
- Suitable for M10 bolts



Type	Fit	Dimension A	Pack.	Weight	Item No.
	mm	mm	pcs	kg/100 pcs.	
<b>249 8-10 ALU-OT</b>	44	Rd 8-10	100	2.100	<b>5311 58 5</b>

**Al** Aluminium /100 pc.

- For round conductor fastening Rd 8-10
  - Suitable for M10 bolts
- Application: Equipotential bonding on PV frames

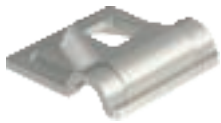

Type	Fit	Dimension A	Pack.	Weight	Item No.
	mm	mm	pcs	kg/100 pcs.	
<b>249 8-10 VA-OT</b>	Rd 8-10	40	100	3.130	<b>5311 55 4</b>

**V2A** Stainless steel, grade 304 /100 pc.

- For round cable Rd 8-10
- Suitable for M10 bolts



Type	Fit	Dimension A	Pack.	Weight	Item No.
	mm	mm	pcs	kg/100 pcs.	
<b>249 8-10 CU-OT</b>	Rd 8-10	40	100	3.580	<b>5311 53 0</b>

**Cu** Copper /100 pc.

- For round cable fastening RD 8-10
- Suitable for M10 bolts

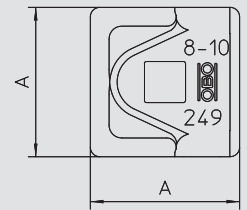
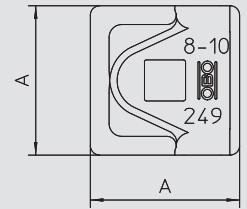
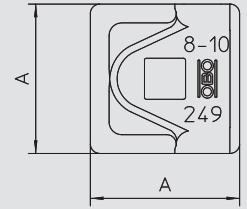
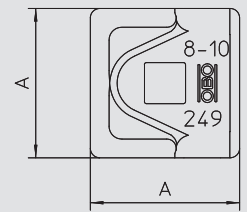

## Rod holder for 16 mm interception and earth entry rods



Type	Fit	Pack.	Weight	Item No.
	mm	pcs	kg/100 pcs.	
<b>113 Z-16</b>	Rd 16	50	6.000	<b>5412 60 9</b>

**Zn** Die-cast zinc **VZ** Galvanised /100 pc.

- For lightning and ground insertion rods Rd 16
- Installed with over-piece and hex-head screws M6 x 16
- With female thread M8 or through hole  $\varnothing$  7 mm

Type	Clamping range D	Hole size	Material thickness	Size	Bolt	Shipping box	Pack.	Weight	Item No.
	mm	mm	mm			pcs	pcs	kg/100 pcs.	
<b>733 16 VA</b>	14-16	6.5 x 10	1.5	M16	M5 x 12	500	50	2.430	<b>1362 01 1</b>

**V2A** Stainless steel, grade 304 /100 pc.

- Bolt material: VA  
 \* Size M16 not suitable for nail device.  
 \* Sizes M16 to PG16 not suitable for bolt-firing tool.



Type	Fit	Pack.	Weight	Item No.
	mm	pcs	kg/100 pcs.	
<b>113 ZN-16</b>	Rd 16	50	10.100	<b>5412 63 3</b>

**Zn** Die-cast zinc **Cu** Copper-plated /100 pc.

- For lightning and ground insertion rods Rd 16
- Installed with over-piece and hex-head screws M6 x 16
- With female thread M8 or through hole  $\varnothing$  7 mm

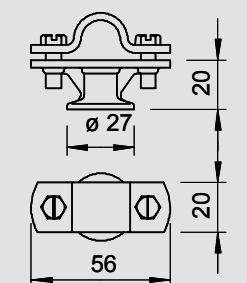
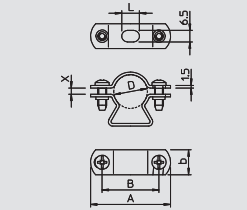
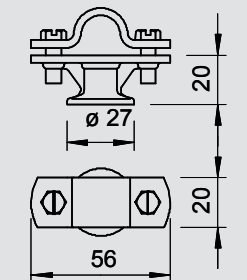



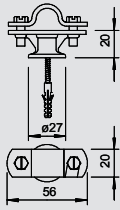

**Rod holder for 16 mm interception and earth entry rods, with screw and anchor**

Type	Fit	Pack.	Weight	Item No.
	mm	pcs	kg/100 pcs.	
<b>113 B-Z-HD</b>	Rd 16	100	6.000	<b>5412 80 3</b>

**Zn** Die-cast zinc      **VZ** Galvanised      /100 pc.

- For lightning and ground insertion rods Rd 16
- Installed with over-piece and hexagonal bolts M6 x 16 (VA)
- Female thread M8 for screwing and through hole for wood screws
- Pre-mounted with wood screw 5 x 60 and plastic dowels 8 x 40

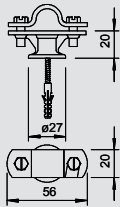

Type	Fit	Pack.	Weight	Item No.
	mm	pcs	kg/100 pcs.	
<b>113 B-HD-16</b>	Rd 16	100	10.100	<b>5412 81 1</b>

**Zn** Die-cast zinc      **Cu** Copper-plated      /100 pc.

- For lightning and ground insertion rods Rd 16
- Installed with over-piece and hexagonal bolts M6 x 16 (VA)
- Female thread M8 for screwing and through hole for wood screws
- Pre-mounted with wood screw 5 x 60 and plastic dowels 8 x 40

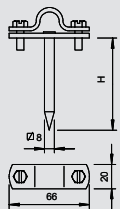

**Rod holder for 16 mm interception and earth entry rods, with square pin**

Type	Fit	Dimension H	Pack.	Weight	Item No.
	mm	mm	pcs	kg/100 pcs.	
<b>112 DIN-100</b>	Rd 16	100	50	12.412	<b>5410 09 6</b>

**St** Steel      **F** Hot-dip galvanised      /100 pc.

- For lightning and ground insertion rods
- Over-piece with 2 hexagonal bolts M6 x 16 (VA)
- With square pin

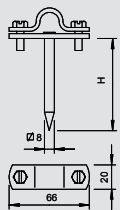

Type	Fit	Dimension H	Pack.	Weight	Item No.
	mm	mm	pcs	kg/100 pcs.	
<b>112 DIN-CU-100</b>	Rd 16	100	50	13.630	<b>5410 30 4</b>

**Cu** Copper      /100 pc.

- For lightning and ground insertion rods
- Over-piece with 2 hexagonal bolts M6 x 16 (VA)
- With square pin

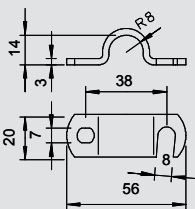

**Crossbar, round cables and interception rods 16 mm**

Type	Fit	Pack.	Weight	Item No.
	mm	pcs	kg/100 pcs.	
<b>156 16</b>	Rd 16	100	3.230	<b>5228 22 0</b>

**St** Steel      **FT** Hot-dip galvanised      /100 pc.

- With open slot for quick installation

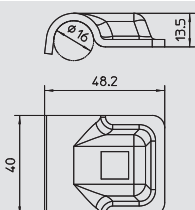

**Clamping block for Rd 16 mm**

Type	Fit	Pack.	Weight	Item No.
	mm	pcs	kg/100 pcs.	
<b>249 VA-OT</b>	16	100	5.700	<b>5311 57 3</b>

**V2A** Stainless steel, grade 304      /100 pc.

- For round conductor fastening RD 16
- Suitable for M10 bolts

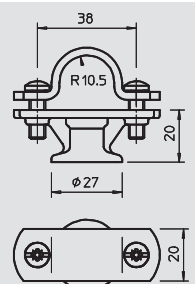

**Rod holder for 20 mm rods**

Type	Fit	Pack.	Weight	Item No.
	mm	pcs	kg/100 pcs.	
<b>113 Z-20</b>	Rd 20	100	8.200	<b>5230 52 7</b>

**Zn** Die-cast zinc      **VZ** Galvanised      /100 pc.

- installed with over-piece and hex-head screws M6 x 16
- with female thread M8 or through hole Ø 7 mm.



# Cable bracket



## Rod holder for 20 mm rods

Type	Clamping range D mm	Hole size mm	Material thickness mm	Size	Bolt	Shipping box pcs	Pack. pcs	Weight kg/100 pcs.	Item No.
<b>733 21 VA</b>	19-21	6,5 x 10	1,5	M20	M5 x 16	500	50	2.740	<b>1362 04 6</b>

V2A Stainless steel, grade 304

/100 pc.

Bolt material: VA

\* Size M16 not suitable for nail device.

\* Sizes M16 to PG16 not suitable for bolt-firing tool.

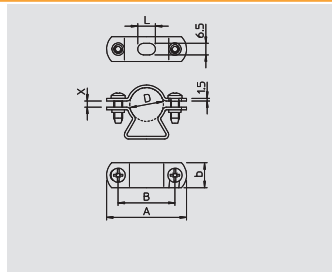

# Connection clamps and connection terminals

## Vario quick connector

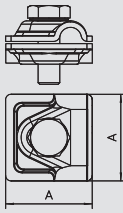

Type	Fit	Dimension A	Pack.	Weight	Item No.
	mm	mm	pcs	kg/100 pcs.	
<b>249 8-10 ST</b>	Rd 8-10	40	50	10.800	<b>5311 50 0</b>
<b>249 B ST</b>	Rd 8-10	40	100	10.800	<b>5311 70 5</b>

**St** Steel **FT** Hot-dip galvanised /100 pc.

- For T, cross and parallel connectors
- Quick installation using hexagonal bolt M10 x 30, high-grade stainless steel
- Conforms to the requirements according to DIN VDE 0185-305 (IEC 62305)

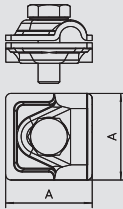

Type	Fit	Dimension A	Pack.	Weight	Item No.
	mm	mm	pcs	kg/100 pcs.	
<b>249 8-10 ALU</b>	Rd 8-10	44	30	6.600	<b>5311 51 9</b>
<b>249 B ALU</b>	Rd 8-10	44	100	7.250	<b>5311 71 3</b>

**Al** Aluminium /100 pc.

- For T, cross and parallel connectors
- Quick installation using hexagonal bolt M10 x 30, high-grade stainless steel
- Conforms to the requirements according to DIN VDE 0185-305 (IEC 62305)

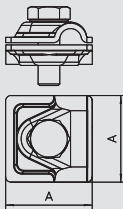

Type	Fit	Dimension A	Pack.	Weight	Item No.
	mm	mm	pcs	kg/100 pcs.	
<b>249 8-10 VA</b>	Rd 8-10	40	50	10.700	<b>5311 55 1</b>

**V2A** Stainless steel, grade 304 /100 pc.

- For T, cross and parallel connectors
- Quick installation using hexagonal bolt M10 x 30, high-grade stainless steel
- Conforms to the requirements according to DIN VDE 0185-305 (IEC 62305)

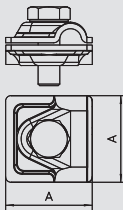

Type	Fit	Dimension A	Pack.	Weight	Item No.
	mm	mm	pcs	kg/100 pcs.	
<b>249 8-10 CU</b>	Rd 8-10	40	50	11.900	<b>5311 52 7</b>

**Cu** Copper /100 pc.

- For T, cross and parallel connectors
- Quick installation using hexagonal bolt M10 x 30, high-grade stainless steel
- Conforms to the requirements according to DIN VDE 0185-305 (IEC 62305)



## Variable bi-metal quick connector

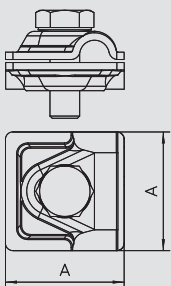

Type	Fit	Dimension A	Material upper part	Material lower part	Pack.	Weight	Item No.
	mm	mm			pcs	kg/100 pcs.	
<b>249 8-10 ZV</b>	Rd 8-10	44	Cu	Al	50	14.220	<b>5311 53 5</b>

**Cu** Copper /100 pc.

- Intermediate plate, copper/aluminium, top section copper and aluminium
- For T, cross and parallel connectors
- Quick installation using hexagonal bolt M10 x 30, high-grade stainless steel
- With spring washer according to DIN 137
- Conforms to the requirements according to DIN VDE 0185-305 (IEC 62305)



## Variable earthing connector Rd 6-8 / 8-10 mm

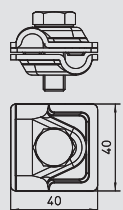

Type	Fit	Dimension A	Pack.	Weight	Item No.
	mm	mm	pcs	kg/100 pcs.	
<b>249 6-10 ST</b>	Rd 6-8 / 8-10	40	50	13.100	<b>5311 41 0</b>

**St** Steel **FT** Hot-dip galvanised /100 pc.

- For T, cross and parallel connectors
- Quick installation using hexagonal bolt M10 x 30, high-grade stainless steel
- Conforms to the requirements according to DIN VDE 0185-305 (IEC 62305)



# Connection clamps and connection terminals



## Variable earthing connector Rd 6-8 / 8-10 mm

Type	Fit	Dimension A	Pack.	Weight	Item No.
	mm	mm	pcs	kg/100 pcs.	
<b>249 6-10 CU</b>	Rd 6-8 / 8-10	40	50	14.540	<b>5311 41 7</b>

**Cu** Copper /100 pc.

- For T, cross and parallel connectors
- Quick installation using hexagonal bolt M10 x 30, high-grade stainless steel
- Conforms to the requirements according to DIN VDE 0185-305 (IEC 62305)

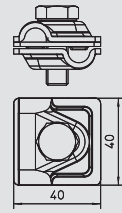

## Vario quick connector Rd 8-10x16

Type	Fit	Pack.	Weight	Item No.
	mm	pcs	kg/100 pcs.	
<b>249 8-10X16 VA</b>	8-10X16	50		<b>5311 59 0</b>

**V2A** Stainless steel, grade 304

- For T, cross and parallel connectors
- Quick installation using hexagonal bolt M10 x 30, high-grade stainless steel
- Conforms to the requirements according to DIN VDE 0185-305 (IEC 62305)

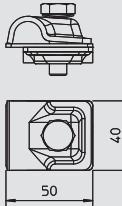

## Connector, Rd 8-10 mm with M10 thread

Type	Fit	Pack.	Weight	Item No.
	mm	pcs	kg/100 pcs.	
<b>5000</b>	Rd 8-10	100	4.630	<b>5304 00 8</b>

**St** Steel **F** Hot-dip galvanised /100 pc.

- With bore hole 10.2 mm
- With thread M10
- Including pre-mounted nut M10 and serrated washer
- Conforms to the requirements according to DIN VDE 0185-305 (IEC 62305)

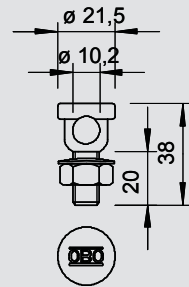

## Connector Rd 8-10 mm, single

Type	Fit	Pack.	Weight	Item No.
	mm	pcs	kg/100 pcs.	
<b>5001 DIN-FT</b>	Rd 8-10	100	7.450	<b>5304 10 5</b>
<b>5001 DIN-FT+VA</b>	Rd 8-10	100	7.450	<b>5304 10 7</b>

**St** Steel **FT** Hot-dip galvanised /100 pc.

- With fix contact clamping screw, nut and serrated washer
- With bore hole 10.2 mm
- With pre-mounted pressure piece, die-cast zinc
- Conforms to the requirements according to DIN VDE 0185-305 (IEC 62305)

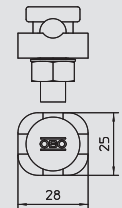

Type	Fit	Pack.	Weight	Item No.
	mm	pcs	kg/100 pcs.	
<b>5001 ZN-CU</b>	Rd 8-10	100	8.760	<b>5304 11 3</b>

**Zn** Die-cast zinc **Cu** Copper-plated /100 pc.

- With fix contact clamping screw, nut and serrated washer
- With bore hole 10.2 mm
- With pre-mounted pressure piece, die-cast zinc
- Conforms to the requirements according to DIN VDE 0185-305 (IEC 62305)

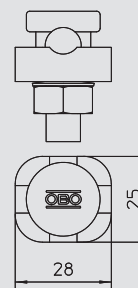

## Connector Rd 8-10 mm, double

Type	Fit	Pack.	Weight	Item No.
	mm	pcs	kg/100 pcs.	
<b>5002 DIN-FT</b>	Rd 8-10	50	14.240	<b>5304 20 2</b>

**St** Steel **FT** Hot-dip galvanised /100 pc.

- With 2 fix contact clamping screws, nut and serrated washer
- Including pre-mounted connecting pressure piece, die-cast zinc or copper-plated die-cast zinc
- Conforms to the requirements according to DIN VDE 0185-305 (IEC 62305)

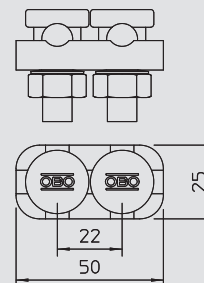

# Connection clamps and connection terminals

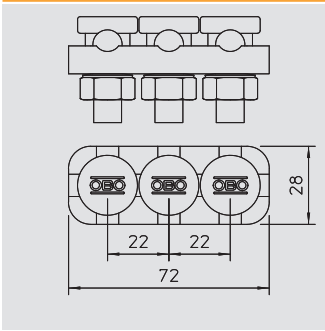

## Connector Rd 8–10 mm, triple



Type	Fit	Pack.	Weight	Item No.
	mm	pcs	kg/100 pcs.	
<b>5003</b>	Rd 8-10	10	22.420	<b>5304 31 8</b>

**TG** Cast iron **FT** Hot-dip galvanised /100 pc.

- With 3 fix contact clamping screws, nut and serrated washer
- With pre-mounted connecting pressure piece, die-cast zinc
- Conforms to the requirements according to DIN VDE 0185-305 (IEC 62305)

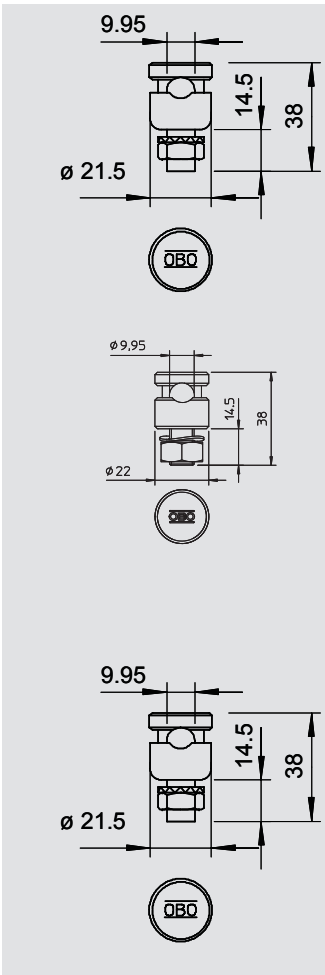

## Connector, Rd 8–10 mm with pressure trough



Type	Fit	Pack.	Weight	Item No.
	mm	pcs	kg/100 pcs.	
<b>5001 N-FT</b>	Rd 8-10	100	5.900	<b>5304 16 4</b>

**St** Steel **FT** Hot-dip galvanised /100 pc.

- With 1 fix contact clamping screw, nut and serrated washer
- Including pre-mounted pressure sump, steel
- Conforms to the requirements according to DIN VDE 0185-305 (IEC 62305)



Type	Fit	Pack.	Weight	Item No.
	mm	pcs	kg/100 pcs.	
<b>5001 N-VA</b>	Rd 8-10	100	6.800	<b>5304 17 6</b>

**V2A** Stainless steel, grade 304

- With 1 fix contact clamping screw, nut and serrated washer
- Including pre-mounted pressure sump, steel
- Conforms to the requirements according to DIN VDE 0185-305 (IEC 62305)



Type	Fit	Pack.	Weight	Item No.
	mm	pcs	kg/100 pcs.	
<b>5001 N-CU</b>	Rd 8-10	100	6.750	<b>5304 17 2</b>

**Cu** Copper /100 pc.

- With 1 fix contact clamping screw, nut and serrated washer
- Including pre-mounted pressure sump, steel
- Conforms to the requirements according to DIN VDE 0185-305 (IEC 62305)

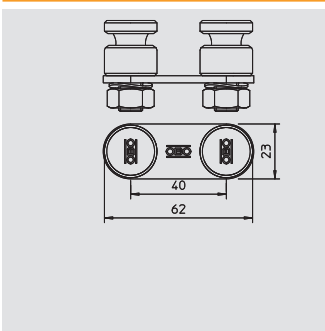

## Connector, Rd 8–10 mm, double, with pressure trough



Type	Fit	Pack.	Weight	Item No.
	mm	pcs	kg/100 pcs.	
<b>5002 N-VA</b>	Rd 8-10	50	16.200	<b>5304 27 0</b>

**V2A** Stainless steel, grade 304

- With 2 Fix-Kontakt clamping bolts, nuts and serrated washers
- With pre-mounted pressure trough made of VA
- Corresponds to the requirements of VDE 0185-305 (IEC 62305)



# Connection clamps and connection terminals



## Connection and end piece with connector

Type	Material symbol	Fit	Pack.	Weight	Item No.
		mm	pcs	kg/100 pcs.	
5009	St	Rd 8-10	50	14.500	5304 97 0

**St** Steel **F** Hot-dip galvanised /100 pc.

- With 2 attaching holes  $\varnothing$  11 mm
- Installed with connector (single-piece) type 5001 DIN-FT
- Conforms to the requirements according to DIN VDE 0185-305 (IEC 62305)

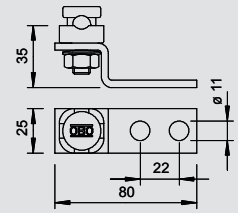

## Connection and end piece



Type	Dimension D	Pack.	Weight	Item No.
	$\varnothing$ mm	pcs	kg/100 pcs.	
5011	11	50	7.064	5304 99 7

**St** Steel **FT** Hot-dip galvanised /100 pc.

- For attaching to steel structures or bolting to earthing fixed points
- For attachments: round conductor Rd 8-10 and flat conductor FL 30 x 3.5
- 2 attaching holes  $\varnothing$  11 mm
- 1 attaching holes  $\varnothing$  D mm

Type	Dimension D	Pack.	Weight	Item No.
	$\varnothing$ mm	pcs	kg/100 pcs.	
5011 VA M10	11	50	7.064	5334 93 4
5011 VA M12	13	50	7.048	5334 94 2

**V4A** Stainless steel, grade 316 Ti /100 pc.

- For attaching to steel structures or bolting to earthing fixed points
- For attachments: round conductor Rd 8-10 and flat conductor FL 30 x 3.5
- 2 attaching holes  $\varnothing$  11 mm
- 1 attaching holes  $\varnothing$  D mm

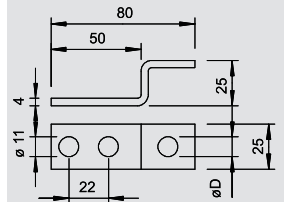
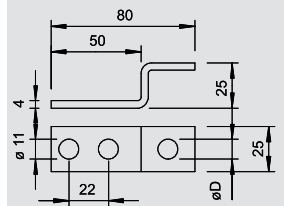

## Connection and end piece, DIN version

Type	Fit	Material symbol	Pack.	Weight	Item No.
	mm		pcs	kg/100 pcs.	
5005 DIN-FT	Rd 8-10	St	50	15.518	5304 60 1

**St** Steel **F** Hot-dip galvanised /100 pc.

- With 2 attaching holes and 1 fix contact clamping screw 5000...
- With 2 attaching holes  $\varnothing$  11 mm
- Conforms to the requirements according to DIN VDE 0185-305 (IEC 62305)

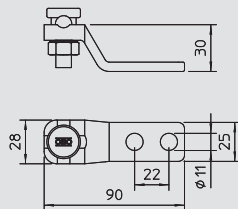

## Connection and end piece with connector and pressure trough

Type	Fit	Pack.	Weight	Item No.
	mm	pcs	kg/100 pcs.	
5005 N-FT	Rd 8-10	50	11.600	5304 66 0

**St** Steel **FT** Hot-dip galvanised /100 pc.

- With 2 attaching holes  $\varnothing$  11 mm
- Including pre-mounted connector 5001 N
- Conforms to the requirements according to DIN VDE 0185-305 (IEC 62305)

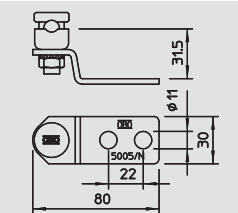

## Parallel connector Rd 8–10 mm, M8 x 25

Type	Fit	Pack.	Weight	Item No.
	mm	pcs	kg/100 pcs.	
259 8-10	Rd 8-10	50	13.230	5315 50 6

**TG** Cast iron **FT** Hot-dip galvanised /100 pc.

- With 2 hex-head screws M8 x 25, hot-dip galvanised steel

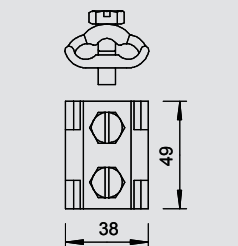

# Connection clamps and connection terminals

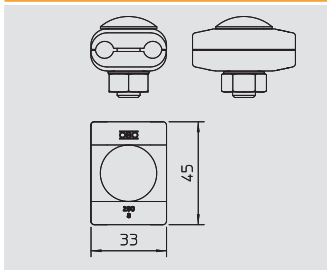

## Parallel connector Rd 8 mm, M10 x 30

Type	Fit	Pack.	Weight	Item No.
	mm	pcs	kg/100 pcs.	
<b>260 8</b>	Rd 8	50	13.930	<b>5315 70 0</b>

- Zn** Die-cast zinc      **G** Electrogalvanised      /100 pc.  
 • With flat, round screw M10 x 30 and hexagonal nut, hot-dip galvanised steel

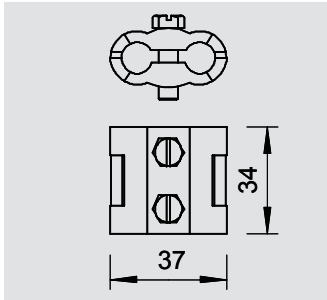
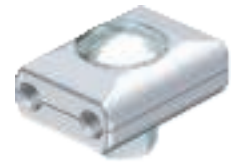

## Parallel connector Rd 8-10 mm, M6 x 20

Type	Fit	Pack.	Weight	Item No.
	mm	pcs	kg/100 pcs.	
<b>260 8-10 MS</b>	Rd 8-10	50	15.820	<b>5315 65 4</b>

- CuZn** Brass      **Cu** Copper-plated      /100 pc.  
 • With 2 hexagonal bolts M6 x 20 from copper

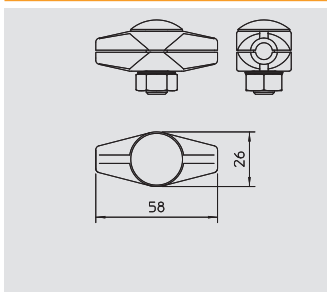

## Straight connector Rd 8 mm

Type	Fit	Pack.	Weight	Item No.
	mm	pcs	kg/100 pcs.	
<b>239</b>	Rd 8	50	12.510	<b>5329 07 8</b>

- Zn** Die-cast zinc      **G** Electrogalvanised      /100 pc.  
 • With flat, round screw M10 x 30 and hexagonal nut M10

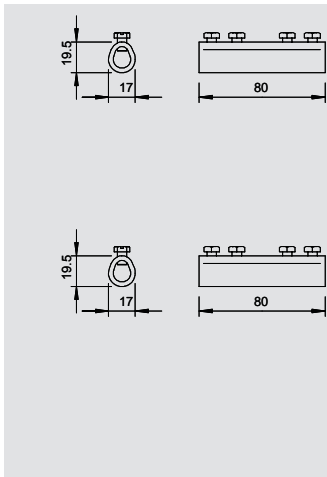

## Straight connector Rd 8-10 mm

Type	Fit	Pack.	Weight	Item No.
	mm	pcs	kg/100 pcs.	
<b>237 N FT</b>	Rd 8-10	50	8.560	<b>5328 20 9</b>

- St** Steel      **F** Hot-dip galvanised      /100 pc.  
 • With 4 hexagonal bolts M6 x 10

Type	Fit	Pack.	Weight	Item No.
	mm	pcs	kg/100 pcs.	
<b>237 N CU</b>	Rd 8-10	50	8.760	<b>5328 28 4</b>

- Cu** Copper      /100 pc.  
 • With 4 hexagonal bolts M6 x 10

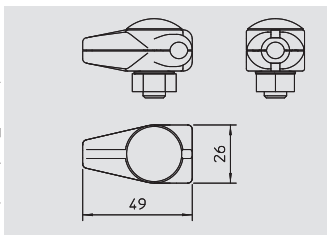
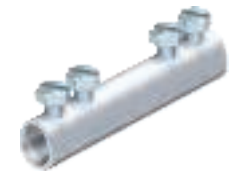

## T connector Rd 8 mm

Type	Fit	Pack.	Weight	Item No.
	mm	pcs	kg/100 pcs.	
<b>244</b>	Rd 8	50	11.580	<b>5311 03 9</b>

- Zn** Die-cast zinc      **G** Electrogalvanised      /100 pc.  
 • With flat, round bolt M10 x 30 and hexagonal nut M10

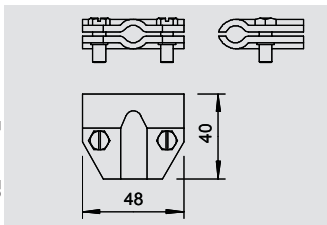
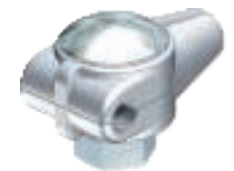

## T connector Rd 8-10 mm

Type	Fit	Pack.	Weight	Item No.
	mm	pcs	kg/100 pcs.	
<b>245 8-10 FT</b>	Rd 8-10	50	9.401	<b>5311 10 1</b>

- St** Steel      **FT** Hot-dip galvanised      /100 pc.  
 • With 2 hexagonal bolts M6 x 16 (VA)



# Connection clamps and connection terminals



## T connector Rd 8–10 mm

Type	Fit	Pack.	Weight	Item No.
	mm	pcs	kg/100 pcs.	
<b>245 8-10 CU</b>	Rd 8 - 10	50	11.560	<b>5311 15 2</b>

**Cu** Copper

- With 2 hexagonal bolts M6 x 16 (VA)

/100 pc.

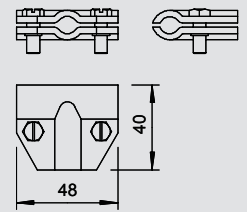

## T connector Rd 8-10 mm, triple-screwed

Type	Fit	Pack.	Weight	Item No.
	mm	pcs	kg/100 pcs.	
<b>247 8-10 FT</b>	Rd 8-10	50	10.934	<b>5311 20 9</b>

**St** Steel

**FT** Hot-dip galvanised

- With 3 hexagonal bolts M6 x 16 (VA)

/100 pc.

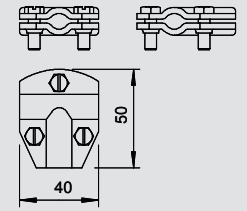

Type	Fit	Pack.	Weight	Item No.
	mm	pcs	kg/100 pcs.	
<b>247 8-10 CU</b>	Rd 8-10	50	10.750	<b>5311 26 8</b>

**Cu** Copper

- With 3 hexagonal bolts M6 x 16 (VA)

/100 pc.

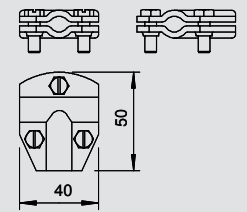

## Cross-connector for round cables and flat conductors

Type	Fit	Pack.	Weight	Item No.
	mm	pcs	kg/100 pcs.	
<b>250</b>	Rd 8-10/FL30	25	10.260	<b>5312 90 6</b>

**St** Steel

**FT** Hot-dip galvanised

- Fit: Rd 8-10 x Rd 8-10
- Fit: Rd 8-10 x FL 30
- Fit: FL 30 x FL 30
- Installed with 2 hexagonal bolts M8 x 20 (F)

/100 pc.

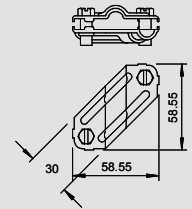

Type	Fit	Pack.	Weight	Item No.
	mm	pcs	kg/100 pcs.	
<b>250 VA</b>	Rd 8-10/FL30	25	10.260	<b>5312 92 2</b>
<b>250 V4A</b>	Rd 8-10/FL30	25	10.260	<b>5312 92 5</b>

**V2A** Stainless steel, grade 304

**V4A** Stainless steel, grade 316 Ti

- Fit: Rd 8-10 x Rd 8-10
- Fit: Rd 8-10 x FL 30
- Fit: FL 30 x FL 30
- Installed with 2 hexagonal bolts M8 x 20 (F)

/100 pc.

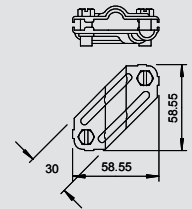

## Cross-connector for round cables and flat conductors DIN

Type	Fit	Pack.	Weight	Item No.
	mm	pcs	kg/100 pcs.	
<b>252 8-10xFL30 FT</b>	8-10 x FL30	25	28.500	<b>5312 65 5</b>

**St** Steel

**F** Hot-dip galvanised

- Fit: Rd 8-10 x FL 30
- Installed with 4 hexagonal bolts M8 x 25 and 4 hexagonal nuts M8

/100 pc.

Type	Fit	Pack.	Weight	Item No.
	mm	pcs	kg/100 pcs.	
<b>252 8-10xFL30V4A</b>	8-10 x FL30	25	28.500	<b>5312 65 6</b>

**V4A** Stainless steel, grade 316 Ti

- Fit: Rd 8-10 x FL 30
- Installed with 4 hexagonal bolts M8 x 25 and 4 hexagonal nuts M8

/100 pc.

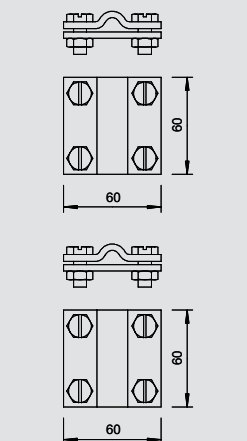



# Connection clamps and connection terminals

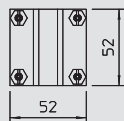
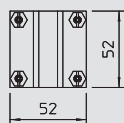
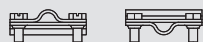

## Cross-connector Rd 8-10 mm



Type	Fit	Pack.	Weight	Item No.
	mm	pcs	kg/100 pcs.	
<b>251 8-10</b>	Rd 8-10	25	11.690	<b>5312 03 5</b>

**St** Steel **FT** Hot-dip galvanised /100 pc.

- For round conductor, fit Rd 8-10 x Rd 8-10
- With 4 hexagonal bolts M6 x 16 (VA)



Type	Fit	Pack.	Weight	Item No.
	mm	pcs	kg/100 pcs.	
<b>251 CU</b>	Rd 8-10	25	12.400	<b>5312 13 2</b>

**Cu** Copper /100 pc.

- 251/Cu...: DIN 48843, Form A for round conductor,
- Fit: Rd 8 - 10 x Rd 8 - 10
  - With 4 hexagonal bolts M6 x 16 (F)

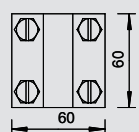
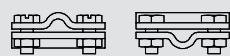

## Cross-connector Rd 8-10 mm, wide version

Type	Fit	Pack.	Weight	Item No.
	mm	pcs	kg/100 pcs.	
<b>253 8X8</b>	Rd 8-10	25	30.700	<b>5312 60 4</b>

**St** Steel **F** Hot-dip galvanised /100 pc.

- Fit: Rd 8-10 x Rd 8-10
- Installed with 4 hexagonal bolts M8 x 25 and 4 hexagonal nuts M8 (F)

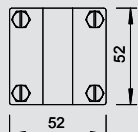

## Cross-connector with intermediate plate for Rd 8-10 mm

Type	Fit	Pack.	Weight	Item No.
	mm	pcs	kg/100 pcs.	
<b>254 DIN 8-10 FT</b>	Rd 8-10	25	16.660	<b>5314 03 8</b>

**St** Steel **FT** Hot-dip galvanised /100 pc.

- For round conductor, fit Rd 8-10 x Rd 8-10
- With separator plate
- 4 hexagonal bolts M6 x 20 and 4 hexagonal nuts M6

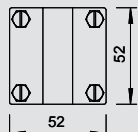

Type	Fit	Pack.	Weight	Item No.
	mm	pcs	kg/100 pcs.	
<b>254 DIN 8-10 CU</b>	Rd 8-10	25	17.410	<b>5314 13 5</b>

**Cu** Copper /100 pc.

- 254/...: DIN 48843, Form B for round conductor,
- Fit: Rd 8 - 10 x Rd 8 - 10, Rd 8 - 10,
  - With separator plate and 4 hexagonal bolts M6 x 20 and 4 hexagon nuts M6 (F), stainless steel (VA)

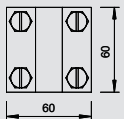

## Cross-connector with intermediate plate for Rd 8-10 mm, wide version



Type	Fit	Pack.	Weight	Item No.
	mm	pcs	kg/100 pcs.	
<b>252 8-10 FT</b>	Rd 8-10	25	33.530	<b>5312 31 0</b>

**St** Steel **FT** Hot-dip galvanised /100 pc.

- Fit: Rd 8-10 x Rd 8-10
- With separator plate
- Installed with 4 hexagonal bolts M8 x 25 and 4 hexagonal nuts M8



# Connection clamps and connection terminals



## Cross-connector with intermediate plate for Rd 8–10 mm, wide version

Type	Fit	Pack.	Weight	Item No.
	mm	pcs	kg/100 pcs.	
<b>252 8-10 V4A</b>	Rd 8-10	25	33.530	<b>5312 31 8</b>

**V4A** Stainless steel, grade 316 Ti /100 pc.

- Fit: Rd 8-10 x Rd 8-10
- With separator plate
- Installed with 4 hexagonal bolts M8 x 25 and 4 hexagonal nuts M8



Type	Fit	Pack.	Weight	Item No.
	mm	pcs	kg/100 pcs.	
<b>252 8-10 CU</b>	Rd 8-10	25	38.940	<b>5312 41 8</b>

**Cu** Copper /100 pc.

- Fit: Rd 8-10 x Rd 8-10
- With separator plate
- Installed with 4 hexagonal bolts M8 x 25 and 4 hexagonal nuts M8

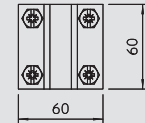
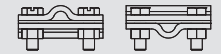
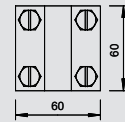

## Cross-connector for Rd 8–10 x Rd 16 mm

Type	Fit	Pack.	Weight	Item No.
	mm	pcs	kg/100 pcs.	
<b>253 10X16</b>	Rd 8-10 x 16	25	29.800	<b>5312 80 9</b>

**St** Steel **F** Hot-dip galvanised /100 pc.

- Fit: Rd 8-10 x Rd 16
- Installed with 4 hexagonal bolts M8 x 25 and 4 hexagonal nuts M8 (F)

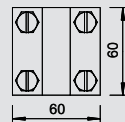

## Cross-connector with intermediate plate for Rd 8–10 x Rd 16 mm

Type	Fit	Pack.	Weight	Item No.
	mm	pcs	kg/100 pcs.	
<b>252 8-10X16 FT</b>	Rd 8-10 x 16	25	38.800	<b>5312 34 5</b>

**St** Steel **FT** Hot-dip galvanised /100 pc.

- Fit: Rd 8-10 x Rd 16
- With separator plate
- Installed with 4 hexagonal bolts M8 x 25 and 4 hexagonal nuts M8
- DIN 48845, Form E

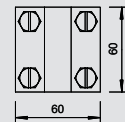

Type	Fit	Pack.	Weight	Item No.
	mm	pcs	kg/100 pcs.	
<b>252 8-10x16 V4A</b>	Rd 8-10 x 16	25	39.000	<b>5312 34 6</b>

**V4A** Stainless steel, grade 316 Ti

- Fit: Rd 8-10 x Rd 16
- With separator plate
- Installed with 4 hexagonal bolts M8 x 25 and 4 hexagonal nuts M8
- DIN 48845, Form E

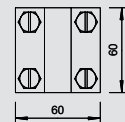

Type	Fit	Pack.	Weight	Item No.
	mm	pcs	kg/100 pcs.	
<b>252 8-10x16 CU</b>	Rd 8-10 x 16	25	43.985	<b>5312 44 2</b>

**Cu** Copper /100 pc.

- Fit: Rd 8-10 x Rd 16
- With separator plate
- Installed with 4 hexagonal bolts M8 x 25 and 4 hexagonal nuts M8
- DIN 48845, Form E

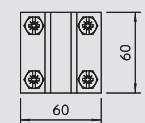

## Folding and construction clamp, 10–20 mm

Type	Fit	Dimension T	Dimension L	Clamping area	Pack.	Weight	Item No.
	mm	mm	mm	mm	pcs	kg/100 pcs.	
<b>5004 DIN-FT 12</b>	Rd 8-10	20	55	max. 12	25	18.730	<b>5304 40 7</b>
<b>5004 DIN-FT 20</b>	Rd 8-10	25	63	10-20	25	30.600	<b>5304 50 4</b>

**TG** Cast iron **FT** Hot-dip galvanised /100 pc.

- Flange thickness to 12 or 10–20 mm
- With pre-mounted Fix-Kontakt clamping screw 5000
- 2 hexagonal bolts M8 x 20, screws made of hot galvanised steel,
- Terminal block made of malleable iron, hot galvanised
- Mounting of the round conductors either vertical or transverse to structure
- Corresponds to the requirements of DIN VDE 0185-305-3

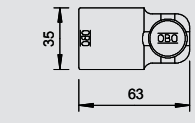
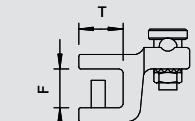

# Connection clamps and connection terminals

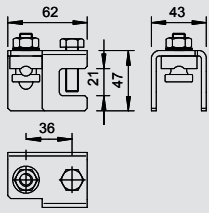

## Construction clamp to 20 mm



Type	Fit	Clamping area	Pack.	Weight	Item No.
	mm	mm	pcs	kg/100 pcs.	
<b>5010 20 FT</b>	Rd 8-10	4-20	25	30.600	<b>5304 52 0</b>

**St** Steel **FT** Hot-dip galvanised /100 pc.

- Round conductors can be installed vertical or transverse to structure
- For affixing to structures with a flange thickness of up to 20 mm
- Affixing to structures with a hexagonal bolt M10
- Conforms to the requirements according to DIN VDE 0185-305 (IEC 62305)

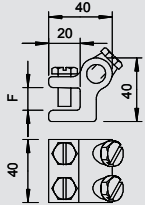
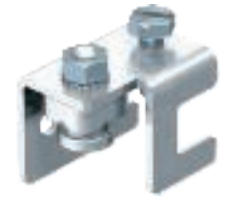

## Connection terminal to 14 mm



Type	Fit	Clamping area	Pack.	Weight	Item No.
	mm	mm	pcs	kg/100 pcs.	
<b>272 8</b>	Rd 8-10	max. 8	50	22.800	<b>5318 08 4</b>
<b>272 14</b>	Rd 8-10	max. 14	50	25.230	<b>5318 14 9</b>

**TG** Cast iron **FT** Hot-dip galvanised /100 pc.

- Flange thickness to 8 and/or 14 mm
- With 4 hexagonal bolts M8
- Conforms to the requirements according to DIN V VDE V 0185-3, Section 4.5

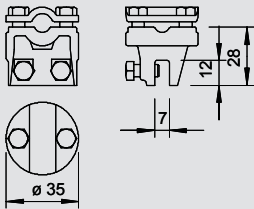

## Folding clamp up to 10 mm plate thickness



Type	Fit	Clamping area	Pack.	Weight	Item No.
	mm	mm	pcs	kg/100 pcs.	
<b>269 8-10</b>	Rd 8-10	max. 7	50	14.460	<b>5317 01 0</b>

**Zn** Die-cast zinc **G** Electrogalvanised /100 pc.

- Plate thickness to 7 mm
- For conductor arrangement transverse and parallel to plate with 4 hexagonal bolts M6 x 16
- Conforms to the requirements according to DIN VDE 0185-305 (IEC 62305)

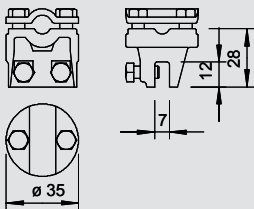

Type	Fit	Clamping area	Pack.	Weight	Item No.
	mm	mm	pcs	kg/100 pcs.	
<b>269 MS</b>	Rd 8-10	max. 7	50	14.480	<b>5317 05 3</b>

**Zn** Die-cast zinc **Cu** Copper-plated /100 pc.

- Plate thickness to 7 mm
- For conductor arrangement transverse and parallel to plate with 4 hexagonal bolts M6 x 16
- Conforms to the requirements according to DIN VDE 0185-305 (IEC 62305)

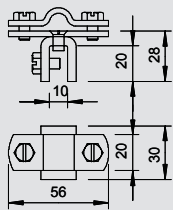

## Folding clamp Rd 8-10 up to 10 mm plate thickness



Type	Fit	Clamping area	Pack.	Weight	Item No.
	mm	mm	pcs	kg/100 pcs.	
<b>270 8-10 FT</b>	Rd 8-10	max. 10	50	13.810	<b>5317 20 7</b>

**St** Steel **FT** Hot-dip galvanised /100 pc.

- Metal thickness to 10 mm
- For cable routing transverse and in parallel to the plate
- Corresponds to the requirements to DIN V VDE V 0185-3 section 4.5

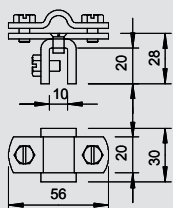

Type	Fit	Clamping area	Pack.	Weight	Item No.
	mm	mm	pcs	kg/100 pcs.	
<b>270 8-10 VA</b>	Rd 8-10	max. 10	50	13.800	<b>5317 20 8</b>

**V2A** Stainless steel, grade 304

- Metal thickness to 10 mm
- For cable routing transverse and in parallel to the plate
- Corresponds to the requirements to DIN V VDE V 0185-3 section 4.5



02\_TBS\_Masterkatalog\_Länder\_2012 / en / 29/05/2012 (LLEExport\_01433) / 29/05/2012

Interception and arrester systems

# Connection clamps and connection terminals



## Folding clamp Rd 8-10 up to 10 mm plate thickness

Type	Fit	Clamping area	Pack.	Weight	Item No.
	mm	mm	pcs	kg/100 pcs.	
<b>270 8-10 CU</b>	Rd 8-10	max. 10	50	14.740	<b>5317 25 8</b>

**Cu** Copper

/100 pc.

- Metal thickness to 10 mm
- For cable routing transverse and in parallel to the plate
- Corresponds to the requirements to DIN V VDE V 0185-3 section 4.5

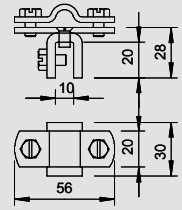

## Folding clamp up to 5 mm plate thickness

Type	Fit	Clamping area	Pack.	Weight	Item No.
	mm	mm	pcs	kg/100 pcs.	
<b>271 8-10</b>	Rd 8-10	max. 5	50	14.060	<b>5317 40 1</b>

**St** Steel **FT** Hot-dip galvanised

/100 pc.

- Plate thickness to 5 mm
- For conductor routing transverse and longitudinal to plate
- With 4 hexagonal bolts M6 x 12
- Conforms to the requirements according to DIN VDE 0185-305 (IEC 62305)
- 271 Cu: with hexagonal bolts stainless steel (VA)

Type	Fit	Clamping area	Pack.	Weight	Item No.
	mm	mm	pcs	kg/100 pcs.	
<b>271 8-10 VA</b>	Rd 8-10	max. 5	50	96.780	<b>5317 48 1</b>

**V2A** Stainless steel, grade 304

/100 pc.

- Plate thickness to 5 mm
- For conductor routing transverse and longitudinal to plate
- With 4 hexagonal bolts M6 x 12
- Conforms to the requirements according to DIN VDE 0185-305 (IEC 62305)
- 271 Cu: with hexagonal bolts stainless steel (VA)

Type	Fit	Clamping area	Pack.	Weight	Item No.
	mm	mm	pcs	kg/100 pcs.	
<b>271 CU</b>	Rd 8-10	max. 5	50	15.230	<b>5317 45 2</b>

**Cu** Copper

/100 pc.

- Plate thickness to 5 mm
- For conductor routing transverse and longitudinal to plate
- With 4 hexagonal bolts M6 x 12
- Conforms to the requirements according to DIN VDE 0185-305 (IEC 62305)
- 271 Cu: with hexagonal bolts stainless steel (VA)

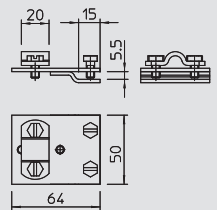
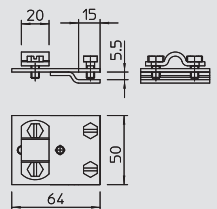
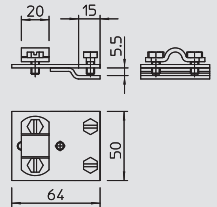

## Folding clamp up to 10 mm plate thickness

Type	Fit	Clamping area	Pack.	Weight	Item No.
	mm	mm	pcs	kg/100 pcs.	
<b>273 8-10</b>	Rd 8-10	max. 10	50	17.000	<b>5317 22 3</b>

**St** Steel **FT** Hot-dip galvanised

/100 pc.

- Plate thickness to 10 mm
- Conductor routing transverse and longitudinal to plate with 2 hexagonal bolts M8 x 10 and 2 hexagonal bolts M8 x 16 (F)

Type	Fit	Clamping area	Pack.	Weight	Item No.
	mm	mm	pcs	kg/100 pcs.	
<b>273 CU</b>	Rd 8-10	max. 10	50	18.500	<b>5317 27 4</b>

**Cu** Copper

/100 pc.

- Plate thickness to 10 mm
- Conductor routing transverse and longitudinal to plate with 2 hexagonal bolts M8 x 10 and 2 hexagonal bolts M8 x 16 (F)
- 273 Cu: with hexagonal bolts, stainless steel (VA)

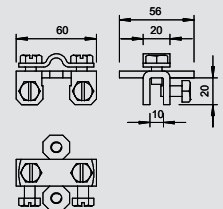
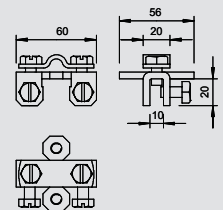

# Connection clamps and connection terminals

## Folding clamp and connection terminal up to 10 mm plate thickness

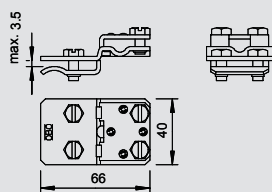
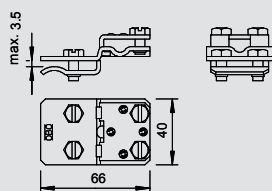

Type	Fit	Clamping area	Pack.	Weight	Item No.
	mm	mm	pcs	kg/100 pcs.	
<b>274 8-10</b>	Rd 8-10	max. 10	50	10.400	<b>5317 42 8</b>

**St** Steel **FT** Hot-dip galvanised /100 pc.

- Plate thickness to 10 mm
- For conductor routing transverse and longitudinal to plate
- 4 hexagonal bolts M6 x 16
- Conforms to the requirements according to DIN VDE 0185-305 (IEC 62305)

Type	Fit	Clamping area	Pack.	Weight	Item No.
	mm	mm	pcs	kg/100 pcs.	
<b>274 CU</b>	Rd 8-10	max. 10	50	11.340	<b>5317 47 9</b>

**Cu** Copper /100 pc.

- Plate thickness to 10 mm
- For conductor routing transverse and longitudinal to plate
- 4 hexagonal bolts M6 x 16
- Conforms to the requirements according to DIN VDE 0185-305 (IEC 62305)



## Gutter clamp RK-FIX

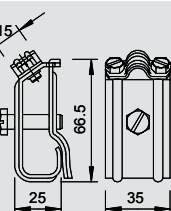
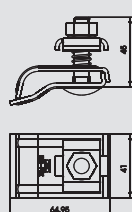
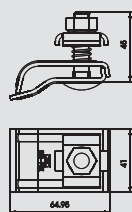
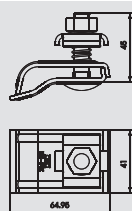

Type	Fit	Material symbol	Inter-face	Pack.	Weight	Item No.
	mm			pcs	kg/100 pcs.	
<b>RK-FIX</b>	2 x Rd 8	St	FT	25	19.100	<b>5316 45 0</b>

**St** Steel **FT** Hot-dip galvanised /100 pc.

- For up to 2 round cables Rd 8
- With double crossbar
- Suitable for all bead thicknesses (15–25 mm)
- With 1 truss-head bolt M10 x 45
- Nut and bolt made of VA stainless steel
- With spring for prefixing for rain gutter

Type	Fit	Material symbol	Inter-face	Pack.	Weight	Item No.
	mm			pcs	kg/100 pcs.	
<b>RK-FIX VA</b>	2 x Rd 8	V2A	–	25	19.100	<b>5316 45 9</b>

**V2A** Stainless steel, grade 304 /100 pc.

- For up to 2 round cables Rd 8
- With double crossbar
- Suitable for all bead thicknesses (15–25 mm)
- With 1 truss-head bolt M10 x 45
- Nut and bolt made of VA stainless steel
- With spring for prefixing for rain gutter
- Tested to DIN EN 50164-1

Type	Fit	Pack.	Weight	Item No.
	mm	pcs	kg/100 pcs.	
<b>RK-FIX CU</b>	2 x Rd 8	25	21.000	<b>5316 46 8</b>

**V2A** Stainless steel, grade 304 **Cu** Copper-plated /100 pc.

- For up to 2 round cables Rd 8
- With double crossbar
- Suitable for all bead thicknesses (15–25 mm)
- With 1 truss-head bolt M10 x 45
- Nut and bolt made of VA stainless steel
- With spring for prefixing for rain gutter
- Tested to DIN EN 50164-1

## Gutter clamp for all bead thicknesses

Type	Fit	Pack.	Weight	Item No.
	mm	pcs	kg/100 pcs.	
<b>267</b>	Rd 8-10	25	13.950	<b>5316 30 8</b>

**St** Steel **FT** Hot-dip galvanised /100 pc.

- Fits all bead thicknesses
- With 1 hexagonal bolt M8 x 30
- 2 hexagonal bolts M6 x 12

Interception and arrester systems

# Connection clamps and connection terminals



## Gutter clamp for all bead thicknesses

Type	Fit	Pack.	Weight	Item No.
	mm	pcs	kg/100 pcs.	
<b>267 VA</b>	Rd 8-10	25	11.360	<b>5316 32 4</b>

V2A Stainless steel, grade 304 /100 pc.

- Fits all bead thicknesses
- With 1 hexagonal bolt M8 x 30
- 2 hexagonal bolts M6 x 12
- VA version also for use as bimetal conductor (holder)

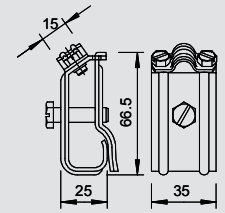

## Gutter clamp for bead thickness 15–22 mm

Type	Fit	Pack.	Weight	Item No.
	mm	pcs	kg/100 pcs.	
<b>262 A-DIN FT</b>	Rd 8-10	25	19.610	<b>5316 21 9</b>

St Steel FT Hot-dip galvanised /100 pc.

- Suitable for bulge thickness 15–22 mm
- With 4 hexagonal bolts M6 x 16 (VA)



Type	Fit	Pack.	Weight	Item No.
	mm	pcs	kg/100 pcs.	
<b>262 A-DIN CU</b>	Rd 8-10	25	20.840	<b>5316 25 1</b>

Cu Copper /100 pc.

- Suitable for bulge thickness 15–22 mm
- With 4 hexagonal bolts M6 x 16 (VA)

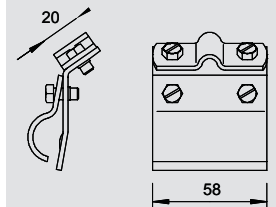
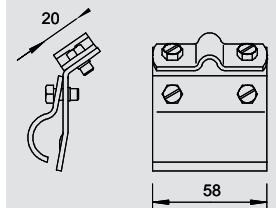

## Roof gutter clamp for all bead thicknesses

Type	Fit	Pack.	Weight	Item No.
	mm	pcs	kg/100 pcs.	
<b>262</b>	Rd 8-10	25	20.300	<b>5316 01 4</b>

St Steel FT Hot-dip galvanised /100 pc.

- With 4 hexagonal bolts M6 x 16
- Fits all bead thicknesses



Type	Fit	Pack.	Weight	Item No.
	mm	pcs	kg/100 pcs.	
<b>262 CU</b>	Rd 8-10	25	20.940	<b>5316 15 4</b>

Cu Copper /100 pc.

- With 4 hexagonal bolts M6 x 16
- Fits all bead thicknesses

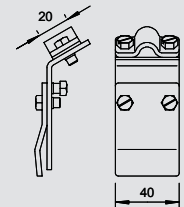
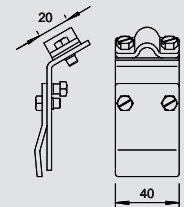

## Bi-metal roof gutter clamp for all bead thicknesses

Type	Fit	Pack.	Weight	Item No.
	mm	pcs	kg/100 pcs.	
<b>262 ZM</b>	Rd 8-10	25	23.100	<b>5316 17 0</b>

St Steel FT Hot-dip galvanised /100 pc.

- Fits all bead thicknesses
- Bi-metal for attaching round conductors aluminium or steel to roof gutters without corrosion to different metals

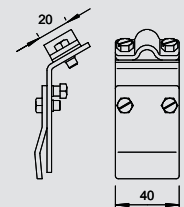

# Connection clamps and connection terminals

## Snow catching grate clamp

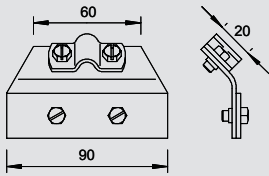

Type	Fit	Pack.	Weight	Item No.
	mm	pcs	kg/100 pcs.	
<b>264</b>	Rd 8-10	25	18.640	<b>5316 51 0</b>

- St** Steel **F** Hot-dip galvanised /100 pc.
- Plate thickness to 8 mm
  - With 4 hexagonal bolts M6 x 16

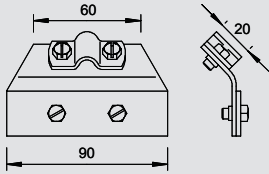

Type	Fit	Pack.	Weight	Item No.
	mm	pcs	kg/100 pcs.	
<b>264 CU</b>	Rd 8-10	25	21.140	<b>5316 55 3</b>

- Cu** Copper /100 pc.
- Plate thickness to 8 mm
  - With 4 hexagonal bolts M6 x 16



## Clamping shoe

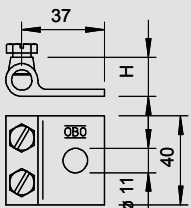

Type	Fit	Pack.	Weight	Item No.
	mm	pcs	kg/100 pcs.	
<b>319 8</b>	Rd 8	25	7.800	<b>5325 30 7</b>
<b>319 10</b>	Rd 10	25	9.650	<b>5325 31 5</b>

- TG** Cast iron **F** Hot-dip galvanised /100 pc.
- With Ø 11 mm attaching hole
  - 2 hexagonal bolts M8 x 16
  - Bolts hot-dip galvanised steel and clamping element hot dipped galvanised cast steel



## Connection terminal, equipotential bonding, Rd 8–10 mm

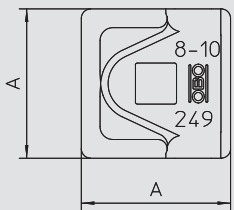

Type	Fit	Dimension A	Pack.	Weight	Item No.
	mm	mm	pcs	kg/100 pcs.	
<b>249 8-10 ST-OT</b>	Rd 8-10	40	100	3.240	<b>5311 50 3</b>

- St** Steel **FT** Hot-dip galvanised /100 pc.
- For round cable fastening RD 8-10
  - Suitable for M10 bolts

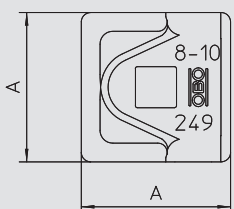
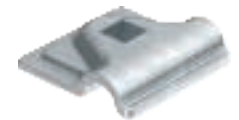

Type	Dimension A	Fit	Pack.	Weight	Item No.
	mm	mm	pcs	kg/100 pcs.	
<b>249 8-10 ALU-OT</b>	44	Rd 8-10	100	2.100	<b>5311 58 5</b>

- Al** Aluminium /100 pc.
- For round conductor fastening Rd 8–10
  - Suitable for M10 bolts
- Application: Equipotential bonding on PV frames

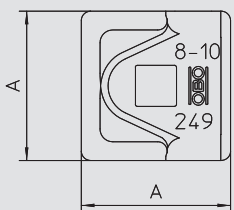

Type	Fit	Dimension A	Pack.	Weight	Item No.
	mm	mm	pcs	kg/100 pcs.	
<b>249 8-10 VA-OT</b>	Rd 8-10	40	100	3.130	<b>5311 55 4</b>

- V2A** Stainless steel, grade 304 /100 pc.
- For round cable Rd 8-10
  - Suitable for M10 bolts

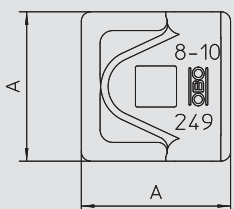
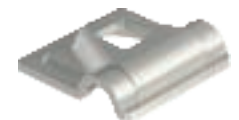

Type	Fit	Dimension A	Pack.	Weight	Item No.
	mm	mm	pcs	kg/100 pcs.	
<b>249 8-10 CU-OT</b>	Rd 8-10	40	100	3.580	<b>5311 53 0</b>

- Cu** Copper /100 pc.
- For round cable fastening RD 8-10
  - Suitable for M10 bolts



# Connection clamps and connection terminals



## Double connection terminal, equipotential bonding, Rd 8-10 mm

Type	Fit	Pack.	Weight	Item No.
	mm	pcs	kg/100 pcs.	
<b>259 A FT 8-OT</b>	-	25	8.000	<b>5315 51 7</b>

- St** Steel **FT** Hot-dip galvanised /100 pc.
- For round cable fastening RD 8
  - Suitable for M10 bolts

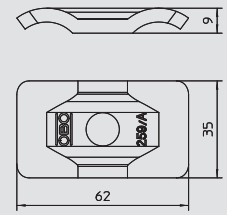

## Connection terminal, equipotential bonding, Rd 16 mm

Type	Fit	Pack.	Weight	Item No.
	mm	pcs	kg/100 pcs.	
<b>249 VA-OT</b>	16	100	5.700	<b>5311 57 3</b>

- V2A** Stainless steel, grade 304 /100 pc.
- For round conductor fastening RD 16
  - Suitable for M10 bolts

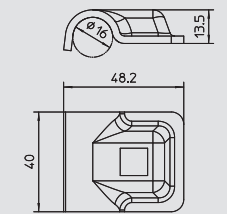

## End piece

Type	Fit	Pack.	Weight	Item No.
	mm	pcs	kg/100 pcs.	
<b>280 8-10</b>	Rd 8-10	20	6.300	<b>5320 01 1</b>

- Zn** Die-cast zinc **G** Electrogalvanised /100 pc.
- With Ø 11 mm attaching hole
  - 2 hexagonal bolts M6 x 12, bolts hot-dip galvanised steel or VA
  - Clamping element from die-cast zinc or copper-plated die-cast zinc

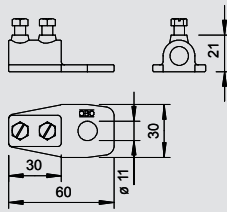

Type	Fit	Pack.	Weight	Item No.
	mm	pcs	kg/100 pcs.	
<b>280 VK</b>	Rd 8-10	20	9.000	<b>5320 05 4</b>

- Zn** Die-cast zinc /100 pc.
- With Ø 11 mm attaching hole
  - 2 hexagonal bolts M6 x 12, bolts hot-dip galvanised steel or VA
  - Clamping element from die-cast zinc or copper-plated die-cast zinc

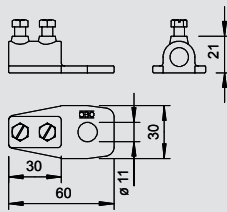

## Universal clamping block Rd 8-10 mm

Type	Fit	Pack.	Weight	Item No.
	mm	pcs	kg/100 pcs.	
<b>324 S-FT</b>	Rd 8-10	50	3.400	<b>5326 30 3</b>

- St** Steel **FT** Hot-dip galvanised /100 pc.
- Including hexagonal bolt M8 x 25, washer and nuts

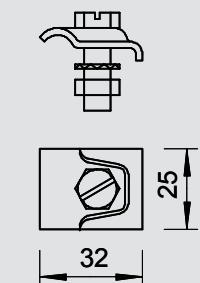

Type	Fit	Pack.	Weight	Item No.
	mm	pcs	kg/100 pcs.	
<b>324 S-VA</b>	Rd 8-10	50	3.400	<b>5326 31 1</b>

- V2A** Stainless steel, grade 304 /100 pc.
- Including hexagonal bolt M8 x 25, washer and nuts

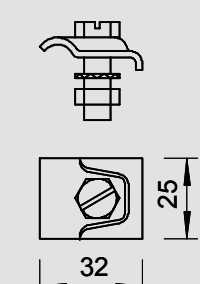

Type	Fit	Pack.	Weight	Item No.
	mm	pcs	kg/100 pcs.	
<b>324 S-CU</b>	Rd 8-10	50	3.660	<b>5326 33 8</b>

- Cu** Copper /100 pc.
- Including hexagonal bolt M8 x 25, washer and nuts

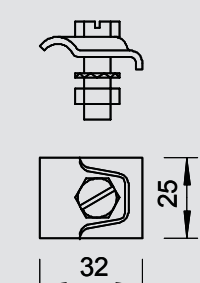



# Connection clamps and connection terminals

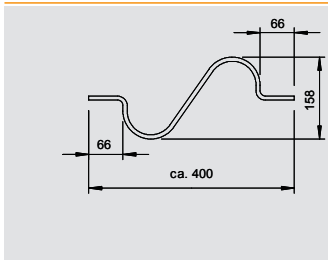

## Expansion piece

Type	Pack.	Weight	Item No.
	pcs	kg/100 pcs.	
<b>172 AR</b>	25	7.500	<b>5218 92 6</b>

- Al** Aluminium /100 pc.
- For equalising temperature-related length changes
  - Necessary on conductor lengths over 20 m
  - From round conductor Rd 8-Al

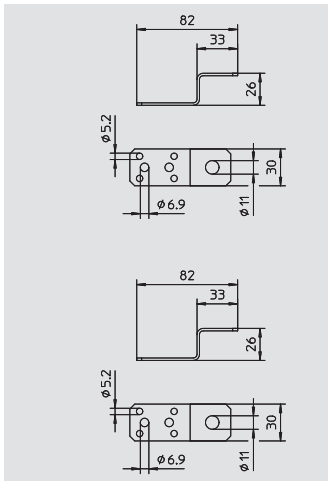

## Connection component

Type	Pack.	Weight	Item No.
	pcs	kg/100 pcs.	
<b>287</b>	50	1.600	<b>5320 70 4</b>

- Al** Aluminium /100 pc.
- With 1 attaching hole Ø 11 mm
  - 4 mounting holes Ø 5.2 mm
  - 2 mounting holes Ø 6.9 mm



Type	Pack.	Weight	Item No.
	pcs	kg/100 pcs.	
<b>287 CU</b>	50	5.600	<b>5320 69 0</b>

- Cu** Copper /100 pc.
- With 1 attaching hole Ø 11 mm
  - 4 mounting holes Ø 5.2 mm
  - 2 mounting holes Ø 6.9 mm

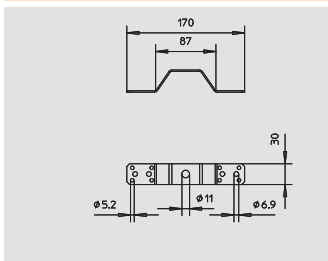

## Connection and bridging component

Type	Pack.	Weight	Item No.
	pcs	kg/100 pcs.	
<b>288 DIN</b>	50	2.900	<b>5320 71 2</b>

- Al** Aluminium /100 pc.
- With 1 attaching hole Ø 11 mm
  - With 2 x 4 mounting hole Ø 5.2 mm
  - With 2 x 2 mounting hole Ø 6.9 mm

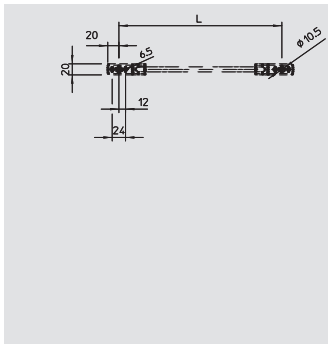

## Bridging cable

Type	Dimension L mm	Pack.	Weight	Item No.
		pcs	kg/100 pcs.	
<b>853 200</b>	200	200	4.840	<b>5331 00 8</b>
<b>853 300</b>	300	100	7.260	<b>5331 01 3</b>
<b>853 400</b>	400	50	9.680	<b>5331 01 7</b>

- Cu** Copper **Al** Aluminium /100 pc.
- From flexible copper cable 16 mm<sup>2</sup>
  - Coating: black, chlorinated india rubber mixture
  - With 1 mounting hole Ø 10.5 mm per attachment side
  - With 2 mounting holes Ø 7.3 mm per attachment side
  - For applications outside or inside suitable

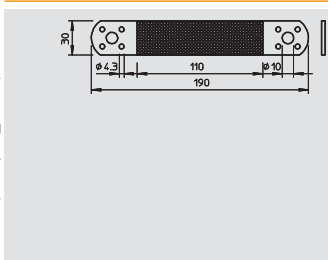

## Connection and expansion strip

Type	Pack.	Weight	Item No.
	pcs	kg/100 pcs.	
<b>856</b>	10	8.125	<b>5331 50 1</b>

- Cu** Copper /100 pc.
- Copper strip 35 mm<sup>2</sup>, tin-plated
  - Highly-flexible with rigid ends
  - Each end with mounting hole Ø 10 mm and 4 mounting holes Ø 4.3 mm

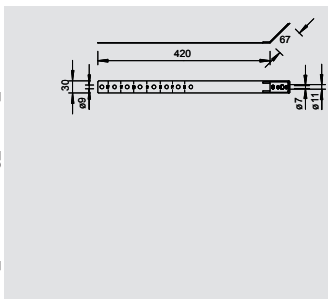

## Universal downspout clip 60–130 mm

Type	Pack.	Weight	Item No.
	pcs	kg/100 pcs.	
<b>301 V</b>	5	11.900	<b>5350 86 7</b>

- St** Steel **FS** Strip-galvanised /100 pc.
- Adjustable for pipes from 60-130 mm
  - With 2x attaching holes Ø 7 mm
  - With 1x attaching hole Ø 9 mm
  - With 1x attaching hole Ø 11 mm
  - Including hexagonal bolt M6 x 20 and nuts M6



# Connection clamps and connection terminals



## Universal downspout clip 60–130 mm

Type	Pack.	Weight	Item No.
	pcs	kg/100 pcs.	
<b>301 V-VA</b>	5	11.800	<b>5350 90 5</b>

**V2A** Stainless steel, grade 304 /100 pc.

- Adjustable for pipes from 60-130 mm
- With 2x attaching holes Ø 7 mm
- With 1x attaching hole Ø 9 mm
- With 1x attaching hole Ø 11 mm
- Including hexagonal bolt M6 x 20 and nuts M6



Type	Pack.	Weight	Item No.
	pcs	kg/100 pcs.	
<b>301 V-CU</b>	5	13.500	<b>5350 88 3</b>

**Cu** Copper /100 pc.

- Adjustable for pipes from 60-130 mm
- With 2x attaching holes Ø 7 mm
- With 1x attaching hole Ø 9 mm
- With 1x attaching hole Ø 11 mm
- Including hexagonal bolt M6 x 20 and nuts M6

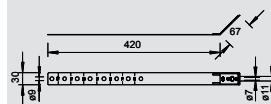
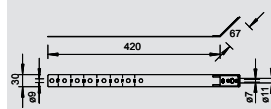

## Downspout clip

Type	For pipe mm	Pack.	Weight	Item No.
		pcs	kg/100 pcs.	
<b>301 DIN-80</b>	80	50	19.580	<b>5350 08 5</b>
<b>301 DIN-90</b>	90	50	21.880	<b>5350 09 3</b>
<b>301 DIN-100</b>	100	50	19.880	<b>5350 10 7</b>
<b>301 DIN-110</b>	110	25	24.920	<b>5350 11 5</b>
<b>301 DIN-120</b>	120	15	26.240	<b>5350 12 3</b>

**St** Steel **FS** Strip-galvanised /100 pc.

- To connect cables and downspouts
- Similar to DIN 48818 C
- Strip galvanised (rd. 275 g/m<sup>2</sup> = 40 µm average value)
- With 1x hexagonal bolt M8 x 20
- With 1x hexagonal nut M8 and 1 stainless steel serrated washer
- With connection hole Ø 11 mm



Type	For pipe mm	Pack.	Weight	Item No.
		pcs	kg/100 pcs.	
<b>301 CU-80</b>	80	50	22.500	<b>5350 68 9</b>
<b>301 CU-90</b>	90	50	24.800	<b>5350 69 7</b>
<b>301 CU-100</b>	100	50	26.230	<b>5350 70 0</b>
<b>301 CU-110</b>	110	25	30.400	<b>5350 71 9</b>
<b>301 CU-120</b>	120	15	31.400	<b>5350 72 7</b>

**Cu** Copper /100 pc.

- With 1x hexagonal bolt M8 x 20
- With 1x hexagonal nut M8 and 1 serrated disc made of rustproof steel
- With connection hole Ø 11 mm

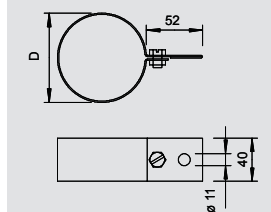
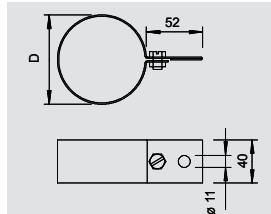

Interception and arrester systems

## Downspout clip for routing Rd 8–10 mm behind pipe

Type	For pipe mm	Pack.	Weight	Item No.
		pcs	kg/100 pcs.	
<b>301 S-100</b>	100	50	5.200	<b>5351 05 7</b>
<b>301 S-120</b>	120	50	5.950	<b>5351 07 3</b>

**St** Steel **FS** Strip-galvanised /100 pc.

- With beading
- For round conductor Rd 8-10
- Including hexagonal bolt M6 x 20 and nuts M6

Type	Material	Inter-symbol face	For pipe mm	Pack.	Weight	Item No.
				pcs	kg/100 pcs.	
<b>301 S-AL-100</b>	Al	—	100	50	4.100	<b>5351 35 9</b>
<b>301 S-AL-120</b>	Al	—	120	50	4.600	<b>5351 37 5</b>

**Al** Aluminium /100 pc.

- With beading
- For round conductor Rd 8-10
- Including hexagonal bolt M6 x 20 and nuts M6



# Connection clamps and connection terminals

## Downspout clip for routing Rd 8–10 mm behind pipe

Type	Material symbol	Inter-face	For pipe mm	Pack. pcs	Weight kg/100 pcs.	Item No.
<b>301 S-VA-100</b>	V2A	—	100	50	5.200	<b>5351 25 1</b>
<b>301 S-VA-120</b>	V2A	—	120	50	5.950	<b>5351 28 6</b>

**V2A** Stainless steel, grade 304

/100 pc.

- With beading
- For round conductor Rd 8-10
- Including hexagonal bolt M6 x 20 and nuts M6

Type	Material symbol	Inter-face	For pipe mm	Pack. pcs	Weight kg/100 pcs.	Item No.
<b>301 S-CU-100</b>	Cu	—	100	50	5.850	<b>5351 45 6</b>
<b>301 S-CU-120</b>	Cu	—	120	50	6.700	<b>5351 47 2</b>

**Cu** Copper

/100 pc.

- With beading
- For round conductor Rd 8-10
- Including hexagonal bolt M6 x 20 and nuts M6

## Pipe clamp

Type	For pipe mm	For pipe inch	Pack. pcs	Weight kg/100 pcs.	Item No.
<b>303 DIN-3/8</b>	17.2	3/8	5	22.600	<b>5102 05 7</b>
<b>303 DIN-1/2</b>	21.3	1/2	5	23.280	<b>5102 07 3</b>
<b>303 DIN-3/4</b>	26.9	3/4	5	25.640	<b>5102 08 1</b>
<b>303 DIN-1</b>	33.7	1	5	28.300	<b>5102 11 1</b>
<b>303 DIN-1 1/4</b>	42.4	1 1/4	5	31.300	<b>5102 13 8</b>
<b>303 DIN-1 1/2</b>	48.3	1 1/2	5	33.220	<b>5102 15 4</b>
<b>303 DIN-2</b>	60.3	2	5	36.840	<b>5102 19 7</b>
<b>303 DIN-2 1/2</b>	76.1	2 1/2	10	39.400	<b>5102 21 9</b>
<b>303 DIN-3</b>	88.9	3	10	43.300	<b>5102 23 5</b>
<b>303 DIN-3 1/2</b>	100	3 1/2	10	64.900	<b>5102 25 1</b>
<b>303 DIN-4</b>	114.3	4	10	66.800	<b>5102 27 8</b>

**St** Steel

**FT** Hot-dip galvanised

/100 pc.

- DIN 48818, Form D
- With Ø 11 mm mounting hole
- 2 hexagonal bolts M8 x 20 (4 inch = M10)
- 2 hex-head nuts M8 (4 inch = M10)

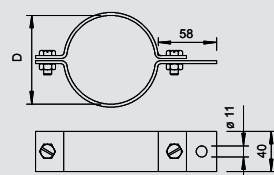

# Connection and separating terminals



## Separating piece, open

Type	Fit	Pack.	Weight	Item No.
	mm	pcs	kg/100 pcs.	
<b>223 O DIN ZN</b>	Rd 8-10/16	50	12.500	<b>5335 14 0</b>

- Zn** Die-cast zinc      **G** Electrogalvanised      /100 pc.
- With 2 hexagonal bolts, stainless steel (VA)
  - Clamping element, die-cast zinc



Type	Fit	Pack.	Weight	Item No.
	mm	pcs	kg/100 pcs.	
<b>223 O DIN MS</b>	Rd 8-10/16	50	14.900	<b>5335 16 7</b>

- Zn** Die-cast zinc      **Cu** Copper-plated      /100 pc.
- With 2 hexagonal bolts, stainless steel (VA)
  - Clamping element, copper-plated die-cast zinc

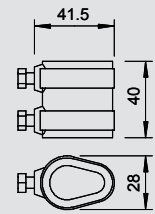
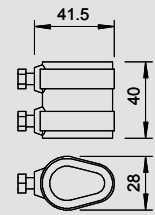

## Separating piece, closed

Type	Fit	Pack.	Weight	Item No.
	mm	pcs	kg/100 pcs.	
<b>223 DIN ZN</b>	Rd 8-10/16	50	10.500	<b>5335 20 5</b>

- Zn** Die-cast zinc      **G** Electrogalvanised      /100 pc.
- For fitting round conductors Rd 8-10 to ground insertion rods Rd 16
  - Including 2 hexagonal bolts, high-grade stainless steel (V2A)
  - Conforms to the requirements according to DIN VDE 0185-305 (IEC 62305)



Type	Fit	Pack.	Weight	Item No.
	mm	pcs	kg/100 pcs.	
<b>223 DIN MS</b>	Rd 8-10/16	50	11.700	<b>5335 25 6</b>

- Zn** Die-cast zinc      **Cu** Copper-plated      /100 pc.
- For fitting round conductors Rd 8-10 to ground insertion rods Rd 16
  - Including 2 hexagonal bolts, high-grade stainless steel (V2A)
  - Conforms to the requirements according to DIN VDE 0185-305 (IEC 62305)

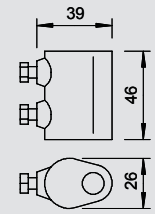
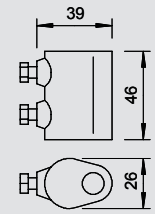

## Universal separating piece

Type	Fit	Pack.	Weight	Item No.
	mm	pcs	kg/100 pcs.	
<b>226 8-10</b>	Rd 8-10/FL30 x 16	50	8.600	<b>5336 00 7</b>

- St** Steel      **FT** Hot-dip galvanised      /100 pc.
- For fitting round conductors Rd 8-10 to Rd 16 or flat conductors FL30
  - Including 2 hexagonal bolts M8 x 20 high-grade stainless steel (V2A)
  - Conforms to the requirements according to VDE 0185-305 (IEC 62305)



Type	Fit	Pack.	Weight	Item No.
	mm	pcs	kg/100 pcs.	
<b>226 VA</b>	Rd 8-10/FL30 x 16	50	8.700	<b>5336 05 8</b>

- V2A** Stainless steel, grade 304      /100 pc.
- For fitting round conductors Rd 8-10 to Rd 16 or flat conductors FL30
  - Including 2 hexagonal bolts M8 x 20 high-grade stainless steel (V2A)
  - Conforms to the requirements according to VDE 0185-305 (IEC 62305)

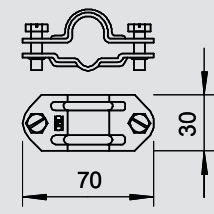
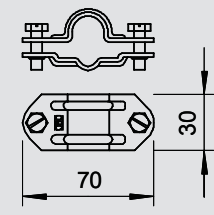

# Connection and separating terminals

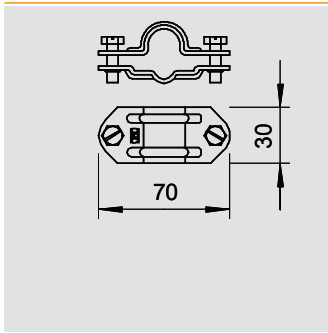

## Universal separating piece



Type	Fit	Pack.	Weight	Item No.
	mm	pcs	kg/100 pcs.	
<b>226 CU</b>	Rd 8-10/FL30 x 16	50	9.700	<b>5336 02 3</b>

- Cu** Copper /100 pc.
- For fitting round conductors Rd 8-10 to Rd 16 or flat conductors FL30
  - Including 2 hexagonal bolts M8 x 20 high-grade stainless steel (V2A)
  - Conforms to the requirements according to VDE 0185-305 (IEC 62305)

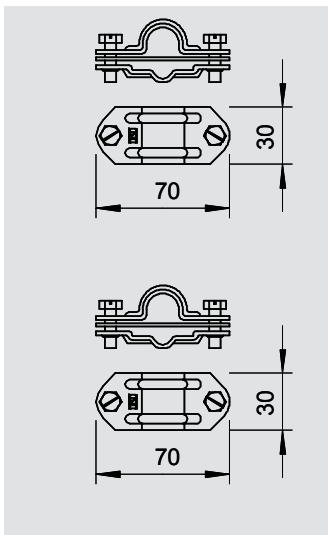

## Universal bi-metal separating piece

Type	Fit	Material upper part	Material lower part	Pack.	Weight	Item No.
	mm			pcs	kg/100 pcs.	
<b>226 ZV VA</b>	Rd 8-10/FL30 x 16	VA	Cu	50	11.000	<b>5336 07 4</b>

- Cu** Copper /100 pc.
- Fit: Rd 8-10 x 16, FL 30 x Rd 16
  - With 2 hexagonal bolts M8 x 20, stainless steel (VA)
  - Intermediate plate, aluminium/copper



Type	Fit	Material upper part	Material lower part	Pack.	Weight	Item No.
	mm			pcs	kg/100 pcs.	
<b>226 ZV CU</b>	Rd 8-10/FL30 x 16	Cu	VA	50	11.900	<b>5336 09 0</b>

- V2A** Stainless steel, grade 304 /100 pc.
- Fit: Rd 8-10 x 16, FL 30 x Rd 16
  - With 2 hexagonal bolts M8 x 20, stainless steel (VA)
  - Intermediate plate, aluminium/copper

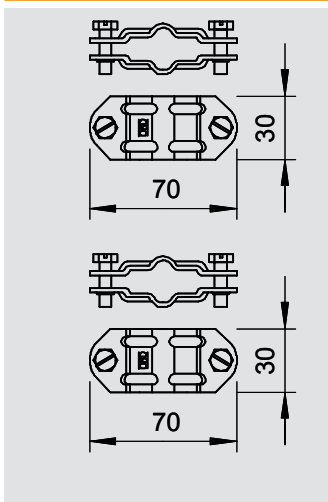

## Separating piece for Rd 8-10 and FL 30 mm

Type	Fit	Pack.	Weight	Item No.
	mm	pcs	kg/100 pcs.	
<b>233 8</b>	Rd 8-10/FL30 x Rd 8-10/FL30	50	8.200	<b>5336 30 9</b>

- St** Steel **FT** Hot-dip galvanised /100 pc.
- For fitting round conductors Rd 8-10 or flat conductors FL 30
  - With 2 hexagonal bolts M8 x 20, stainless steel (VA)



Type	Fit	Pack.	Weight	Item No.
	mm	pcs	kg/100 pcs.	
<b>233 VA</b>	Rd 8-10/FL30 x Rd 8-10/FL30	50	8.300	<b>5336 34 1</b>

- V2A** Stainless steel, grade 304 /100 pc.
- For fitting round conductors Rd 8-10 or flat conductors FL 30
  - With 2 hexagonal bolts M8 x 20, stainless steel (VA)

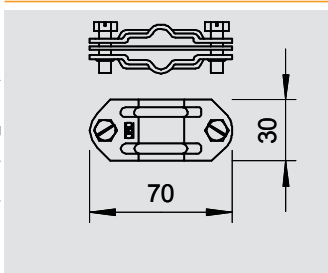

## Bi-metal separating piece for Rd 8-10 and FL 30 mm

Type	Fit	Material upper part	Material lower part	Pack.	Weight	Item No.
	mm			pcs	kg/100 pcs.	
<b>233 ZV</b>	Rd 8-10/FL30 x Rd 8-10/FL30	Cu	VA	50	10.100	<b>5336 37 6</b>

- V2A** Stainless steel, grade 304 /100 pc.
- For fitting round conductors Rd 8-10 to flat conductors FL 30
  - With 2 hexagonal bolts M8 x 20, stainless steel (VA)
  - Intermediate plate aluminium/copper, top section copper, bottom section stainless steel

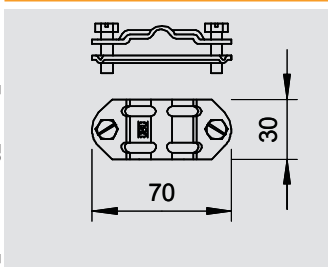

## Separating piece for Rd 8-10 and FL 30-40 mm

Type	Fit	Pack.	Weight	Item No.
	mm	pcs	kg/100 pcs.	
<b>233 A VA</b>	8-10xFL30-40	25	8.300	<b>5336 45 7</b>

- V2A** Stainless steel, grade 304 /100 pc.
- Fit: Rd 8-10 x FL 30-40
  - With 2 hexagonal bolts M8 x 20 (VA)



# Connection and separating terminals

## Bi-metal separating piece for Rd 8–10 and FL 30–40 mm



Type	Fit	Material upper part	Material lower part	Pack.	Weight	Item No.
	mm			pcs	kg/100 pcs.	
<b>233 A ZV</b>	Rd 8-10 x FL30-40	Cu	VA	25	10.400	<b>5336 50 3</b>

**Cu** Copper /100 pc.

- Fit: Rd 8-10 x FL 30-40, FL 30 x FL 30-40
- With 2 hexagonal bolts M8 x 20, stainless steel (VA)
- Intermediate plate, aluminium/copper
- Top section copper, bottom section stainless steel

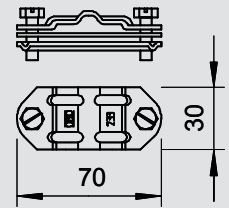

## Malleable iron separating piece



Type	Fit	Pack.	Weight	Item No.
	mm	pcs	kg/100 pcs.	
<b>292 DIN</b>	Rd 8-10 x FL30	50	19.259	<b>5340 01 2</b>

**TG** Cast iron **F** Hot-dip galvanised /100 pc.

- For round conductor/flat conductor
- Fit: Rd 8-10 x FL 30
- With 2 hexagonal bolts M8 x 25 and 2 hexagonal nuts M8, stainless steel (VA)
- Clamping parts, hot-dip galvanised cast iron

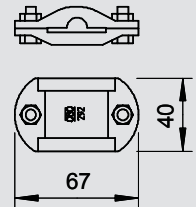

## Rod clamp



Type	Fit	Pack.	Weight	Item No.
	mm	pcs	kg/100 pcs.	
<b>108 B DIN</b>	Rd 8-10/16	10	13.970	<b>5416 56 6</b>

**St** Steel **FT** Hot-dip galvanised /100 pc.

- Rod clamp for connecting round conductors Rd 8–10 to connector rods Rd 16
- Mounted with 2 hexagonal bolts M8 x 16 and M6 x 12
- Adapter from malleable iron
- Crossbar and bolts from hot dip galvanized steel

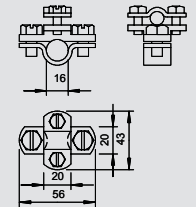

## Connection clip



Type	For deep earthers	Fit	Pack.	Weight	Item No.
	Ø mm	mm	pcs	kg/100 pcs.	
<b>2745 20 MS</b>	20	7-12,5/S95 mm <sup>2</sup>	5	16.000	<b>5001 56 0</b>

**CuZn** Brass **Cu** Copper-plated /pc.

- For earthing rod connector Ø 20 or conductors 95 mm<sup>2</sup>
- For round conductor attachments Rd 7-12.5 with hexagonal bolts M10 x 25, copper (Cu)

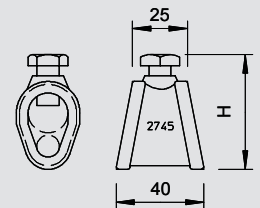

## Number plates



Type	Fit	Pack.	Weight	Item No.
	mm	pcs	kg/100 pcs.	
<b>311 N-ALU 8-10</b>	RD 8 - 10 / FL30	50	2.500	<b>3049 25 6</b>
<b>311 N-ALU 16</b>	RD 16 - FL30	50	2.800	<b>3049 34 5</b>

**Al** Aluminium /100 pc.

- To identify the point of separation to DIN 48821
- Suitable for universal labelling (e.g. stamped numbers)



Type	Fit	Pack.	Weight	Item No.
	mm	pcs	kg/100 pcs.	
<b>311 N-VA 8-10</b>	RD 8 - 10 / FL30	50	5.600	<b>3049 22 1</b>
<b>311 N-VA 16</b>	RD 16 - FL30	50	6.400	<b>3049 32 9</b>

**V2A** Stainless steel, grade 304 /100 pc.

- To identify the point of separation to DIN 48821
- Suitable for universal labelling (e.g. stamped numbers)



Type	Fit	Pack.	Weight	Item No.
	mm	pcs	kg/100 pcs.	
<b>311 N-CU 8-10</b>	RD 8 - 10 / FL30	50	6.400	<b>3049 20 5</b>
<b>311 N-CU 16</b>	RD 16 - FL30	50	6.800	<b>3049 30 2</b>

**Cu** Copper /100 pc.

- To identify the point of separation to DIN 48821
- Suitable for universal labelling (e.g. stamped numbers)

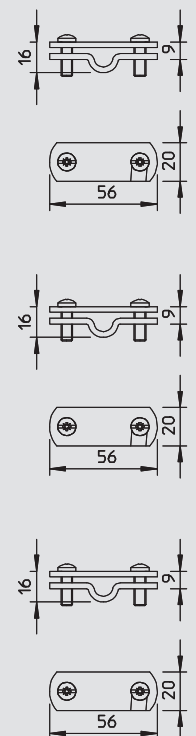

**Interception/earth entry rod, rounded-off on both sides**



Type	Length mm	Nominal size Ø mm	Pack. pcs	Weight kg/100 pcs.	Item No.
<b>101 A-1500</b>	1,500	16	10	240.000	<b>5400 15 5</b>

**St** Steel **FT** Hot-dip galvanised /100 pc.

- Full material Ø 16 mm
- Rounded on both sides
- Suitable for FangFix stand system



Type	Length mm	Nominal size Ø mm	Pack. pcs	Weight kg/100 pcs.	Item No.
<b>200 V4A-1500</b>	1,500	16	10	242.000	<b>5420 50 4</b>
<b>200 V4A-2000</b>	2,000	16	1	320.000	<b>5420 53 9</b>

**V4A** Stainless steel, grade 316 Ti /100 pc.

- Both ends rounded



Type	Length mm	Nominal size Ø mm	Pack. pcs	Weight kg/100 pcs.	Item No.
<b>101 A-CU</b>	1,500	16	10	272.100	<b>5400 62 7</b>

**Cu** Copper /100 pc.

- Full material Ø 16 mm
- Rounded on both sides
- Suitable for FangFix stand system

**Interception/earth entry rod with connection tabs**

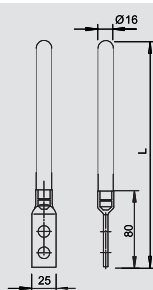

Type	Length mm	Nominal size Ø mm	Pack. pcs	Weight kg/100 pcs.	Item No.
<b>101 F1500</b>	1,500	16	10	240.000	<b>5424 15 1</b>
<b>101 F2000</b>	2,000	16	10	320.000	<b>5424 20 8</b>

**St** Steel **FT** Hot-dip galvanised /100 pc.

- With 2 attaching holes Ø 12 mm
- One end rounded

**Earth entry rod, tapered and partially insulated**



Type	Length mm	Nominal size Ø mm	Pack. pcs	Weight kg/100 pcs.	Item No.
<b>204 KS-2000</b>	2,000	16/10	1	230.000	<b>5430 01 1</b>
<b>204 KS-2500</b>	2,500	16/10	1	310.000	<b>5430 06 2</b>

**St** Steel **F** Hot-dip galvanised /pc.

- 16 mm earth entry with 10 mm connection
- With mounted heat-shrinkable sleeve (corrosion protection)

**Earth entry rod with separating piece and connector**

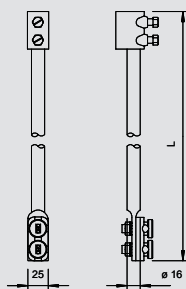

Type	Fit mm	Pack. pcs	Weight kg/100 pcs.	Item No.
<b>204 KL-1500</b>	Rd 8-10	10	260.700	<b>5430 15 1</b>

**St** Steel /100 pc.

- With separating piece type 223 DIN and connector type 5002 DIN

# Accessories



## Underfloor test box

Type	Pack.	Weight	Item No.
	pcs	kg/100 pcs.	
<b>5700 DIN</b>	1	680.000	<b>5106 00 1</b>

/pc.

- Without base
- Made of cast iron, painted black to DIN 48839-K
- Without separating piece
- Can be subjected to up to 1.5 tonne loads according to DIN EN 50085-2-2

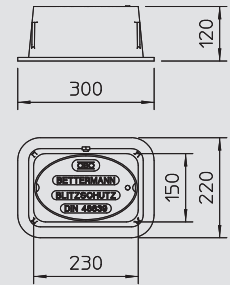

## Underfloor test box with integrated separation point

Type	Pack.	Weight	Item No.
	pcs	kg/100 pcs.	
<b>5700 A DIN</b>	1	555.000	<b>5106 02 8</b>

/pc.

- Without base
- Made of cast iron, painted black
- With integrated separation point for round conductors Rd 8–10 and flat conductor up to FL 40
- Can be subjected to up to 1.5 tonne loads according to DIN EN 50085-2-2

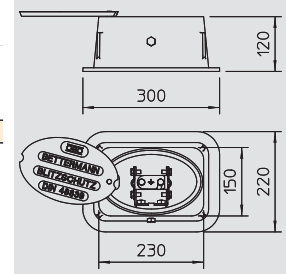

## Inspection door

Type	Pack.	Weight	Item No.
	pcs	kg/100 pcs.	
<b>5800 VZ</b>	1	46.000	<b>5106 13 3</b>

**St** Steel **FS** Strip-galvanised

/pc.

- Lightweight design for flush-mounted separation points
- Claw length approx. 80 mm

Type	Pack.	Weight	Item No.
	pcs	kg/100 pcs.	
<b>5800 VA</b>	1	46.000	<b>5106 14 1</b>

**V2A** Stainless steel, grade 304

/pc.

- Lightweight design for flush-mounted separation points
- Claw length approx. 80 mm

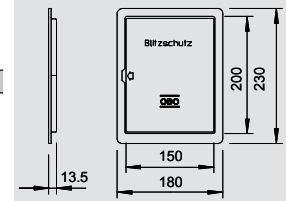
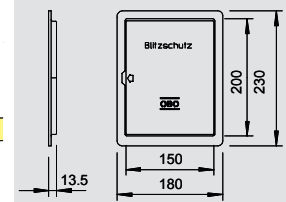

## Magnetic card PCS

Type	Pack.	Weight	Item No.
	PU	kg/100 PUs	
<b>PCS</b>	1	8.000	<b>5091 43 8</b>

/VPE

Magnetic card for recording pulsed/lightning currents.

- Contents = 10 pieces

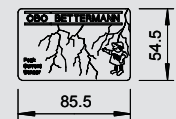

## Magnetic card and holder

Type	Pack.	Weight	Item No.
	PU	kg/100 PUs	
<b>MK-B</b>	1	31.000	<b>5091 32 2</b>

/VPE

PCS magnetic card to record pulse/lightning currents including holder

- Holder can be leaded
- For mounting on round conductor Rd 8-10
- Simple holder mounting through clamping
- 1 PU = 10 units

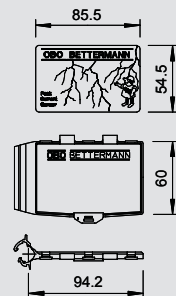



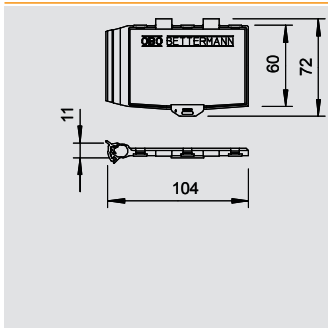

**Magnetic card holder**

Type	Pack.	Weight	Item No.
	PU	kg/100 PUs	
<b>PCS-H</b>	1	31.000	<b>5091 52 7</b>



Magnetic card holder for mounting PCS cards.

- Sealable holder
- For installing on round conductor Rd 8-10
- Simple holder installation by means of clamp
- 1 PU = 10 pieces

/VPE

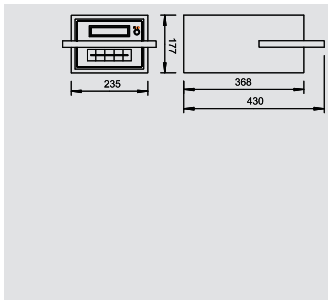

**Magnetic card reader**

Type	Country version	Nominal voltage V	Measuring range	Measuring tolerances	Pack.	Weight	Item No.
					pcs	kg/100 pcs.	
<b>PCS-CS-D</b>	EN	230	3- 120 kA	< 2 kA (< 2%)	1	750.000	<b>5091 68 3</b>
<b>PCS-CS-GB</b>	GB	230	3- 120 kA	< 2 kA (< 2%)	1	750.000	<b>5091 69 1</b>



Magnetic card reader for reading and analysing PCS cards.

- Inc. rechargeable battery for 4 h continuous, no-mains operation
- Large, clear display

/pc.

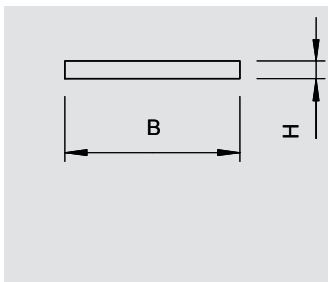

**Plastic corrosion protection strip**

Type	Width mm	Length m	Pack.	Weight	Item No.
			pcs	kg/100 pcs.	
<b>356 50</b>	50	10	1	71.500	<b>2360 05 5</b>
<b>356 100</b>	100	10	1	122.200	<b>2360 10 1</b>



Petrolatum

/pc.

- Approx. 1.1 mm thick
- Width: 50 mm or 100 mm, made of petrolatum-coated chemical fibre fabric
- Can be processed cold

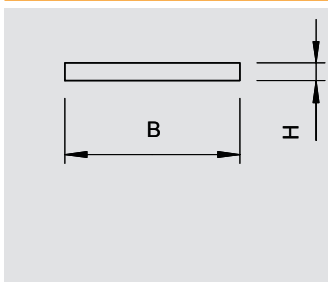

**Flat lead**

Type	Length m	Width mm	Pack.	Weight	Item No.
			kg	kg/100 pcs.	
<b>198 60</b>	21	60	1	100.000	<b>5101 06 9</b>



/kg

- Material thickness 0.55 mm
- Strip width 60 mm
- Roll weight: 7 kg (+/- 0.5 kg)
- Ordering size per roll: 7kg

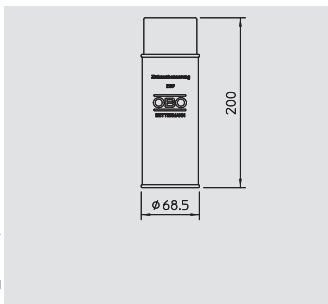

**Zinc repairs**

Type	Dimension	Pack.	Weight	Item No.
		pcs	kg/100 pcs.	
<b>ZSF</b>	400 ml	1	45.000	<b>2362 97 0</b>



/pc.

Zinc spray for treatment of unprotected surfaces and cutting edges. Can contents: 400 ml.

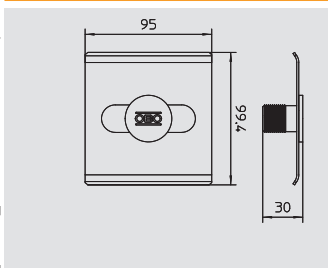

**TrayFix mounting adapter for mesh cable trays on FangFix system**

Type	Dimension	Pack.	Weight	Item No.
		pcs	kg/100 pcs.	
<b>TrayFix</b>	ø20mm	25	9.850	<b>5403 10 0</b>



/100 pc.

- Mounting system for fastening mesh cable trays on FangFix blocks of 10 or 16 kg for cable routing on flat roofs.
- Minimum width of the mesh cable tray: 100 mm

# Accessories



## Angler spreading anchor

Type	Length mm	Bore hole Ø mm	Shipping box pcs	Dowel Ø mm	Pull-out force N min/concrete	Pack. pcs	Weight kg/100 pcs.	Item No.
<b>910 N 5x25 GRW</b>	25	5	9,000	5	300	100	0.051	<b>2349 04 3</b>
<b>910 N 6x30 GRW</b>	30	6	5,000	6	550	100	0.052	<b>2349 05 1</b>
<b>910 N 6x60 GRW</b>	60	6	3,000	6	550	100	0.080	<b>2349 07 8</b>
<b>910 N 8x40 GRW</b>	40	8	3,000	8	800	100	0.140	<b>2349 08 6</b>
<b>910 N 10x50 GRW</b>	50	10	1,500	10	1,150	50	0.306	<b>2349 10 8</b>
<b>910 N 12x60 GRW</b>	60	12	750	12	1,900	25	0.459	<b>2349 12 4</b>

**PA** Polyamide /100 pc.

Required minimum screw length = anchor length + component thickness + 1 x screw Ø.  
Withdrawal force applies to wood screws of the largest screw diameter, required safety values must be taken into account.

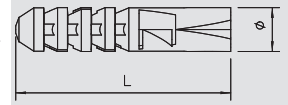

## Screw-in anchor with M6 thread

Type	Shank length mm	Shank-Ø mm	Thread length mm	Wood thread outer-Ø mm	Shipping box pcs	Pack. pcs	Weight kg/100 pcs.	Item No.
<b>985 M6 25</b>	25	4.3	8	5	3,000	100	0.412	<b>3133 02 8</b>
<b>985 M6 35</b>	35	4.3	8	5	2,000	100	0.533	<b>3133 03 6</b>

**St** Steel **G** Electrogalvanised /100 pc.

With wood screw shank and M6 thread.

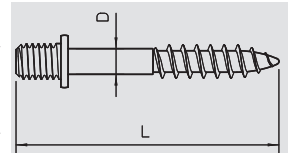

## Screw-in anchor with M8 thread

Type	Shank length mm	Thread length mm	Wood thread outer-Ø mm	Shipping box pcs	Pack. pcs	Weight kg/100 pcs.	Item No.
<b>985 M8 35</b>	35	10	6	1,200	100	1.288	<b>3133 23 0</b>

**St** Steel **G** Electrogalvanised /100 pc.

With wood screw shank and M8 thread.

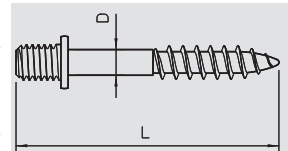

## Directional irons

Type	Length mm	Pack. pcs	Weight kg/100 pcs.	Item No.
<b>364</b>	297	1	35.000	<b>3051 01 3</b>

**St** Steel **FT** Hot-dip galvanised /pc.

• Directional iron for bending and aligning conductors

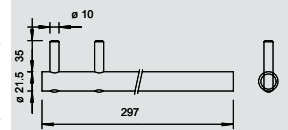

## Wire straightening machine

Type	Pack. pcs	Weight kg/100 pcs.	Item No.
<b>5900</b>	1	3,300.000	<b>3059 00 6</b>

**St** Steel /pc.

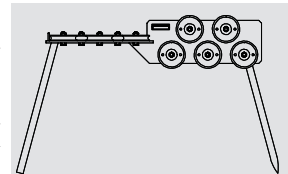

- Factory-set for round conductor Rd 8
- Structure, steel, painted
- Straightening rolls, galvanised cast iron







## Insulated lightning protection

	Insulated lightning protection	382
	OBO isCon® system	388



# Insulated lightning protection



## Insulated lightning protection set, 3-corner fastening

Type	Dimension D Ø mm	Dimension L mm	Dimension H mm	Pack. pcs	Weight kg/100 pcs.	Item No.
<b>101 3-ES-16</b>	16	750	1,500	1	207.100	<b>5408 97 6</b>

/pc.

3-corner fastening for an insulated interception unit at the separating distance  $s$ .

- Mounting on walls and roof structures with two fastening plates
- Acceptance of interception rods and round cables with 8, 16 and 20 mm diameter

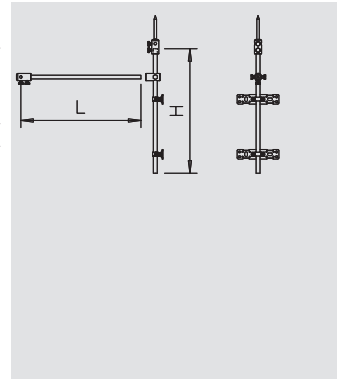

## Insulated lightning protection set, V fastening

Type	Dimension D Ø mm	Dimension L mm	Pack. pcs	Weight kg/100 pcs.	Item No.
<b>101 VS-16</b>	16	750	1	201.800	<b>5408 97 8</b>

/pc.

V fastening for an insulated interception unit at the separating distance  $s$ .

- Mounting on walls and roof structures with two wall connection brackets
- Acceptance of interception rods and round cables with 8, 16 and 20 mm diameter

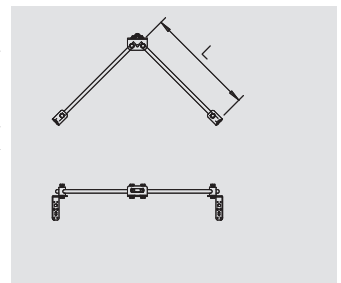

## Insulated lightning protection set, IR fastening

Type	Dimension D Ø mm	Dimension L mm	Pack. pcs	Weight kg/100 pcs.	Item No.
<b>101 FS-16</b>	16	750	1	235.500	<b>5408 98 0</b>

/pc.

Fold fastening for insulated interception unit at separating spacing  $s$ .

- Mounting on folds with thicknesses of up to 20 mm.
- Seat for interception rods and round cables of 8, 16 and 20 mm diameter

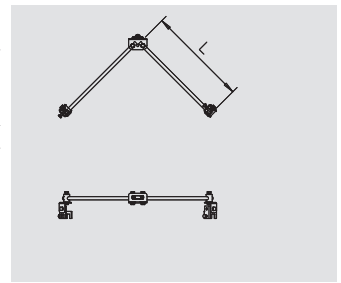

## Insulated lightning protection set, VRS fastening

Type	Dimension D Ø mm	Dimension L mm	Pack. pcs	Weight kg/100 pcs.	Item No.
<b>101 VRS-16</b>	16	750	1	209.400	<b>5408 98 2</b>

/pc.

Pipe V fastening: For an insulated interceptor unit at the separation distance, see mounting on pipes with two pipe clips. To accept interception rods and round conductors of 8, 16 and 20 mm diameter.

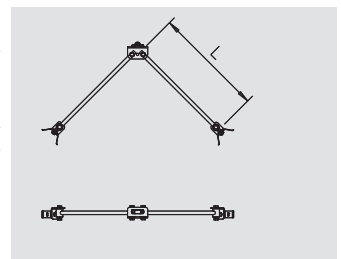

## Insulating rod

Type	Nominal size Ø mm	Length mm	Pack. pcs	Weight kg/100 pcs.	Item No.
<b>101 20-3000</b>	20	3,000	5	190.000	<b>5408 10 5</b>
<b>101 20-6000</b>	20	6,000	5	380.000	<b>5408 14 8</b>
<b>101 16-750</b>	16	750	5	30.000	<b>5408 10 7</b>
<b>101 16-1500</b>	16	1,500	5	60.000	<b>5408 10 8</b>
<b>101 16-3000</b>	16	3,000	5	120.000	<b>5408 10 9</b>

**GFK** Fibre-glass-reinforced plastic

/pc.

To erect insulated interception devices to VDE 0185-305 (IEC 62305),  $km = 0.7$

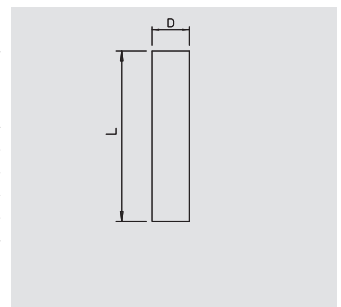

## T connector

Type	Dimension d Ø mm	Length mm	Dimension D Ø mm	Pack. pcs	Weight kg/100 pcs.	Item No.
<b>101 IT</b>	20	65	40	10	20.000	<b>5408 15 6</b>
<b>101 IT-16</b>	16	60	30	10	11.475	<b>5408 15 8</b>

**Al** Aluminium

/pc.

T-link for installation of insulation rods.

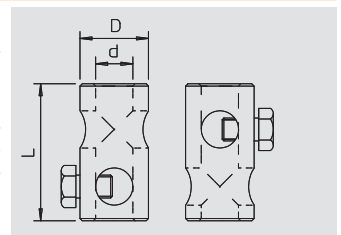

# Insulated lightning protection

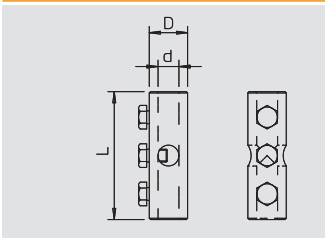

## K connector

Type	Dimension d Ø	Length	Dimension D	Pack.	Weight	Item No.
	mm	mm	Ø mm	pcs	kg/100 pcs.	
<b>101 IK</b>	20	100	40	10	20.000	<b>5408 29 6</b>
<b>101 IK-16</b>	16	100	30	10	27.090	<b>5408 29 8</b>

Al Aluminium

/pc.

K-link for installation of insulation rods.

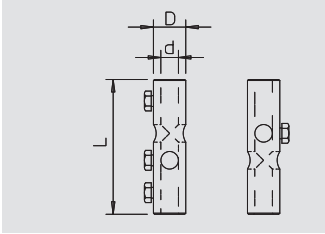

## DK connector

Type	Dimension d Ø	Length	Dimension D	Pack.	Weight	Item No.
	mm	mm	Ø mm	pcs	kg/100 pcs.	
<b>101 IDK</b>	20	125	40	10	40.000	<b>5408 24 5</b>
<b>101 IDK-16</b>	16	125	30	10	25.990	<b>5408 24 7</b>

Al Aluminium

/pc.

DK-connector link for installing insulation rods type 101 I.

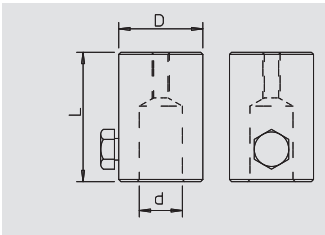

## Wall connection

Type	Dimension d Ø	Length	Dimension D	Pack.	Weight	Item No.
	mm	mm	Ø mm	pcs	kg/100 pcs.	
<b>101 IW-M10</b>	20	60	40	10	20.000	<b>5408 68 7</b>
<b>101 W-16</b>	16	60	30	10	14.200	<b>5408 68 9</b>

Al Aluminium

/pc.

With female thread M8 for installing insulating rods to structures or walls.

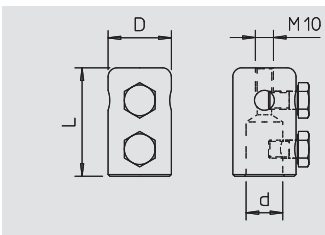

## End piece

Type	Dimension d Ø	Length	Dimension D	Pack.	Weight	Item No.
	mm	mm	Ø mm	pcs	kg/100 pcs.	
<b>101 IES</b>	20	60	35	10	20.000	<b>5408 39 3</b>
<b>101 IES-16</b>	16	60	30	10	10.000	<b>5408 39 5</b>

Al Aluminium

/pc.

End piece for attaching round conductors Rd 8-10 and interception tips, type 101 ISP.

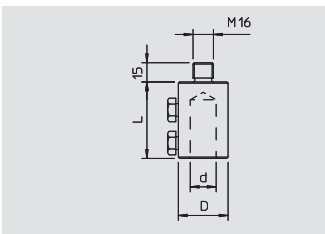

## Connection piece

Type	Dimension d Ø	Length	Dimension D	Pack.	Weight	Item No.
	mm	mm	Ø mm	pcs	kg/100 pcs.	
<b>101 A-M16</b>	20	60	40	10	20.000	<b>5408 35 0</b>
<b>101 A-16</b>	16	60	30	10	13.000	<b>5408 35 2</b>

Al Aluminium

/pc.

Fitting with M16 thread for installation on stands with M16 female thread.

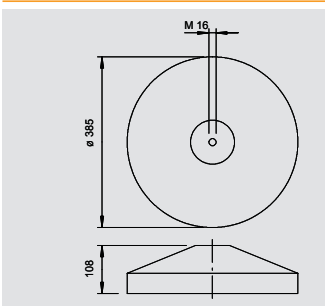

## Stand 16 kg with female thread

Type	Nominal size Ø	Thread	Pack.	Weight	Item No.
	mm		pcs	kg/100 pcs.	
<b>101 B-16 M16</b>	385	M16	1	1.600.000	<b>5402 95 6</b>

/100 pc.

- Weight 16 kg
- From frost-resistant concrete
- Female thread M16
- Recommended interception rod length max. 3.0 m, depending on wind load zone

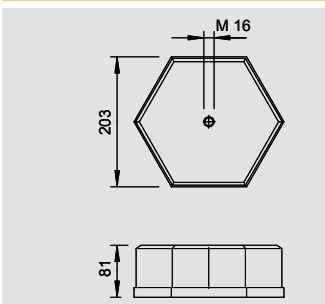

## Stand 6.9 kg with female thread

Type	Thread	Pack.	Weight	Item No.
		pcs	kg/100 pcs.	
<b>101 ST</b>	M16	4	690.000	<b>5402 89 1</b>

/100 pc.

- Weight 6.9 kg
- From frost-resistant concrete
- Female thread M16
- Recommended interception rod length max. 1.0 m



02\_TBS\_Masterkatalog\_Länder\_2012 / en / 29/05/2012 (LLEExport\_01433) / 29/05/2012

Insulated lightning protection and OBO isCon system



# Insulated lightning protection



## Connection joint

Type	Dimension d Ø	Length	Dimension D	Pack.	Weight	Item No.
	mm	mm	Ø mm	pcs	kg/100 pcs.	
<b>101 IAG</b>	20	107	40	10	40.000	<b>5408 50 4</b>
<b>101 IAG-16</b>	16	107	30	10	27.160	<b>5408 50 6</b>

Al Aluminium

/pc.

Attaching link for installation on concrete stones with thread M16 on slanting roof surfaces.

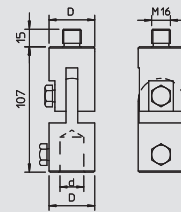

## Articulated connector

Type	Dimension d Ø	Length	Dimension D	Pack.	Weight	Item No.
	mm	mm	Ø mm	pcs	kg/100 pcs.	
<b>101 IGL</b>	20	127	40	10	40.000	<b>5408 62 8</b>
<b>101 IGL-16</b>	16	127	30	10	32.000	<b>5408 63 0</b>

Al Aluminium

/pc.

Link for installation of insulation pipes.

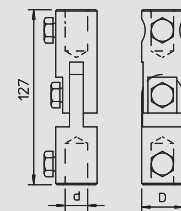

## Extension

Type	Dimension d Ø	Length	Dimension D	Pack.	Weight	Item No.
	mm	mm	Ø mm	pcs	kg/100 pcs.	
<b>101 IV</b>	20	60	40	10	20.000	<b>5408 55 5</b>
<b>101 IV-16</b>	16	60	30	10	16.000	<b>5408 55 7</b>

Al Aluminium

/pc.

Extension of insulating rods

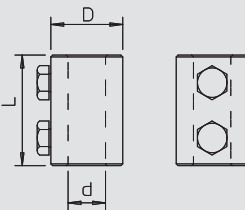

## FangFix reducing sleeve

Type	Colour	Fit	Pack.	Weight	Item No.
		mm	pcs	kg/100 pcs.	
<b>101 RH-16</b>	Black	16	25	0.190	<b>5408 10 1</b>

PA Polyamide

/100 pc.

Reduces the drill hole of the FangFix block from Ø 20 mm to Ø 16 mm. Suitable for the installation of GFK insulating rods of Ø 16 mm.

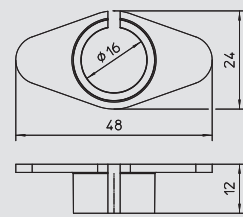

## Concrete block for FangFix-System 16 kg

Type	Nominal size Ø	Pack.	Weight	Item No.
	mm	pcs	kg/100 pcs.	
<b>F-FIX-S16</b>	365	1	1,700.000	<b>5403 22 7</b>

/100 pc.

- 16 kg stone of Ø 365 mm, high level of stability
- Concrete, frost-resistant
- Stackable

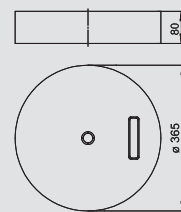

## Base for FangFix system 16 kg

Type	Nominal size Ø	Pack.	Weight	Item No.
	mm	pcs	kg/100 pcs.	
<b>F-FIX-B16</b>	373	10	12.600	<b>5403 23 5</b>

PP Polypropylene

/100 pc.

Edge protection with integrated dowel (basic) suitable for FangFix system.

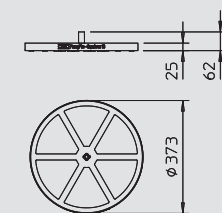

## Concrete block for FangFix system 10 kg

Type	Nominal size Ø	Pack.	Weight	Item No.
	mm	pcs	kg/100 pcs.	
<b>F-FIX-S10</b>	289	1	1,000.000	<b>5403 11 7</b>

/100 pc.

- 10 kg stone of Ø 289 mm, high level of stability
- Concrete, frost-resistant
- Stackable

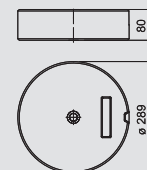



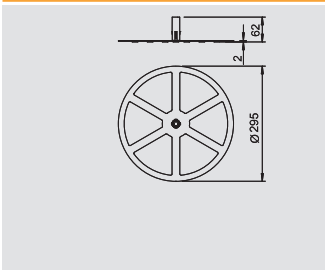

## Base for FangFix system 10 kg

Type	Nominal size Ø mm	Pack. pcs	Weight kg/100 pcs.	Item No.
<b>F-FIX-B10</b>	295	10	5.800	<b>5403 12 4</b>

PP Polypropylene /100 pc.  
Edge protection with integrated dowel (basic) suitable for FangFix 10 system.

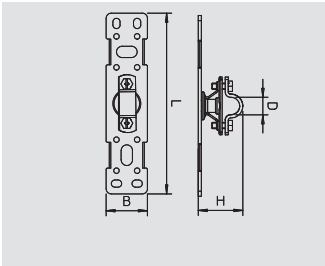

## Fastening plate

Type	Length mm	Dimension B mm	Dimension H mm	Pack. pcs	Weight kg/100 pcs.	Item No.
<b>101 BP-16</b>	175	40	42	1	21.200	<b>5408 98 4</b>

To mount insulating rods on constructions or walls  
Plate made of VA stainless steel  
Holder and crosspiece for 16 and 20 mm rods and Rd 8–10 mm

/pc.

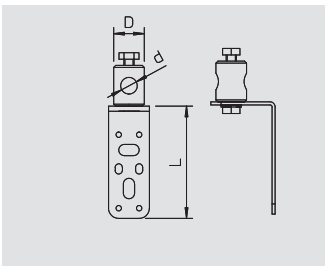

## Wall connection, angled

Type	Dimension d Ø mm	Dimension L mm	Dimension D mm	Pack. pcs	Weight kg/100 pcs.	Item No.
<b>101 WG-16</b>	16	110	30	1	27.960	<b>5408 98 6</b>

- Wall connection for GFK rods
- Dimension D Ø: 16 mm

/pc.

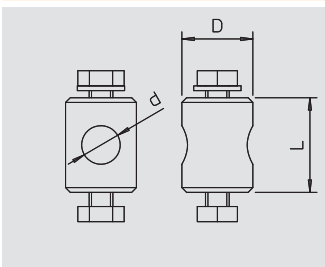

## Fastening bolt

Type	Dimension d Ø mm	Dimension L mm	Dimension D mm	Pack. pcs	Weight kg/100 pcs.	Item No.
<b>101 BB-16</b>	16	40	30	1	13.920	<b>5408 98 8</b>

For GFK rods, Dimension D Ø: 16 mm

/pc.

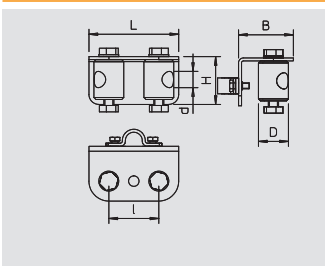

## Holder, V support

Type	Dimension d Ø mm	Dimension L mm	Dimension H mm	Dimension B mm	Pack. pcs	Weight kg/100 pcs.	Item No.
<b>101 HV-16</b>	16	90	55	48	1	50.700	<b>5408 99 0</b>

- Rod holder to accept two GFK rods
- Dimension D Ø: 16 mm

/pc.

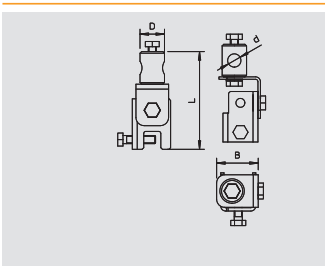

## Fold fastening

Type	Dimension d Ø mm	Dimension L mm	Dimension D mm	Pack. pcs	Weight kg/100 pcs.	Item No.
<b>101 F-16</b>	16	121	30	1	45.120	<b>5408 99 2</b>

To fasten a GFK rod on constructions of 4 to 20 mm, Dimension D Ø: 16 mm

/pc.

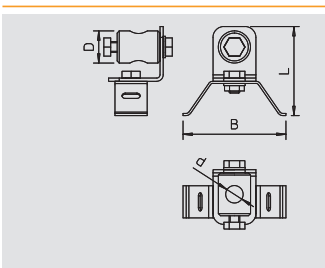

## Pipe fastening

Type	Dimension d Ø mm	Dimension L mm	Dimension D mm	Dimension B mm	Pack. pcs	Weight kg/100 pcs.	Item No.
<b>101 R-16</b>	16	81	30	96	1	26.830	<b>5408 99 4</b>

For pipe fastening of a GFK rod using tightening strap, Dimension D Ø: 16 mm

/pc.



# Insulated lightning protection



## Multi-Adapter

Type	Dimension d Ø	Dimension L	Dimension D	Dimension B	Pack.	Weight	Item No.
	mm	mm	Ø mm	mm	pcs	kg/100 pcs.	
<b>101 MA-16</b>	16	91	30	40	1	36.280	<b>5408 99 6</b>

/pc.

- Connector for two GFK rods
- Dimension D Ø: 16 mm.

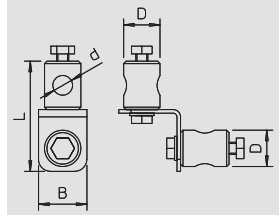

## Rod holder

Type	Fit	Pack.	Weight	Item No.
	mm	pcs	kg/100 pcs.	
<b>113 Z-20</b>	Rd 20	100	8.200	<b>5230 52 7</b>

Zn Die-cast zinc      VZ Galvanised

/100 pc.

- installed with over-piece and hex-head screws M6 x 16
- with female thread M8 or through hole Ø 7 mm.

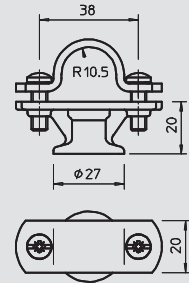

## Interception tip

Type	Length	Pack.	Weight	Item No.
	mm	pcs	kg/100 pcs.	
<b>101 ISP M10</b>	110	10	10.000	<b>5408 45 8</b>

Al Aluminium

/pc.

Interception tip for attaching to end piece, type 101 IES, with M10 thread

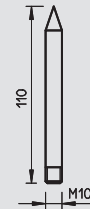

## Water repellent

Type	Length	Pack.	Weight	Item No.
	mm	pcs	kg/100 pcs.	
<b>101 IAB</b>	18	10	2.000	<b>5408 73 3</b>

Al Aluminium

/pc.

Water repellent for mounting on insulation rods with d = 20 mm

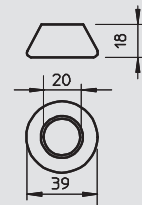

## Adjustable insulating beam – pipe

Type	Pack.	Weight	Item No.
	pcs	kg/100 pcs.	
<b>ISAV1000R</b>	1	130.000	<b>5408 84 9</b>

GFK Fibre-glass-reinforced plastic

/pc.

Variable spacer for cables and interception rods to maintain the separation distance.

- Infinitely adjustable distance range (L = 550–1,000 mm)
- Made of fibre glass-reinforced plastic (km = 0.7)
- For pipe mounting (including 2 m tightening strap and tension jack)



## Adjustable insulating beam – wall

Type	Pack.	Weight	Item No.
	pcs	kg/100 pcs.	
<b>ISAV1000W</b>	1	130.000	<b>5408 85 2</b>

GFK Fibre-glass-reinforced plastic

/pc.

Variable spacer for cables and interception rods to maintain the separation distance.

- Infinitely adjustable distance range (L = 550–1,000 mm)
- Made of fibre glass-reinforced plastic (km = 0.7)
- For wall mounting with 10 4.2 mm fastening holes and 4 6.9 mm fastening holes

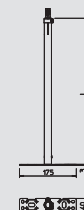

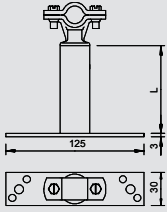

## Insulated spacer

Type	Length mm	Fit mm	Pack. pcs	Weight kg/100 pcs.	Item No.
<b>ISO-A-500</b>	500	Rd 16	15	36.000	<b>5408 80 6</b>
<b>ISO-A-800</b>	800	Rd 16	15	55.000	<b>5408 81 4</b>
<b>ISO-A-1030</b>	1,080	Rd 16	15	68.000	<b>5408 82 0</b>

Al Aluminium

/pc.

- To fasten interception rods  $\varnothing$  16 mm
- Mounting stand with 4 connection holes  $\varnothing$  6.5 mm and 2 connection holes  $\varnothing$  8.5 mm



# OBO isCon® system



## isCon® arrester

Type	Colour	Cross-section mm <sup>2</sup>	Nominal size Ø mm	Normal ring ca. m	Pack. m	Weight kg/100 m	Item No.
isCon 750 SW	Black	35	23	25	25	205.400	5408 00 2
isCon 750 SW	Black	35	23	100	100	103.400	5408 00 4
isCon 750 SW	Black	35	23	250	250	93.400	5408 00 6

/100 m

Surface discharge-free and high voltage-resistant insulated arrester to maintain the separation distance according to IEC 62305. Equivalent separation spacing  $s \leq 0.75$  m in the air.

Please refer to the mounting instructions for information on routing the OBO isCon® cable.

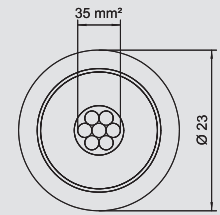

## isCon® arrester in light grey

Type	Colour	Cross-section mm <sup>2</sup>	Nominal size Ø mm	Normal ring ca. m	Pack. m	Weight kg/100 m	Item No.
isCon 750 LGR	Light grey	35	26	25	25	224.000	5407 99 5
isCon 750 LGR	Light grey	35	26	100	100	122.000	5407 99 7

/100 m

Surface discharge-free and high voltage-resistant insulated arrester to maintain the separation distance according to IEC 62305. Equivalent separation spacing  $s \leq 0.75$  m in the air.

Please refer to the mounting instructions for information on routing the OBO isCon® cable.

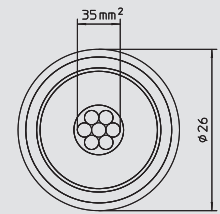

## Insulation removal pliers

Type	Clamping range D mm	Pack. pcs	Weight kg/100 pcs.	Item No.
isCon stripper	23-26	1	138.000	5408 00 9

/pc.

Pliers to remove the insulation of the OBO isCon® cable.

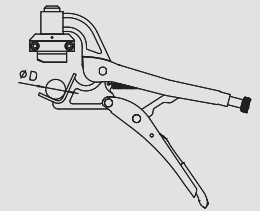

## Spare blade

Type	Dimension	Pack. pcs	Weight kg/100 pcs.	Item No.
isCon cut	34mm	5	1.200	5408 01 1

/pc.

• Replacement blade for replacing the isCon® stripping pliers

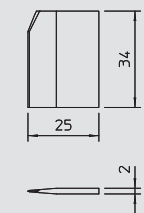

## Connection element

Type	Dimension D Ø mm	Fit mm	Pack. pcs	Weight kg/100 pcs.	Item No.
isCon connect	23	10	2	21.500	5408 02 2

V2A Stainless steel, grade 304

/pc.

Screw-on termination of the connection for the isCon® cable. Including heat-shrinkable sleeve and screw lock.

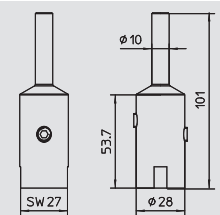

## Potential connection

Type	Fit mm	Pack. pcs	Weight kg/100 pcs.	Item No.
isCon PAE	Ø 17-25mm	2	36.500	5408 03 6

V2A Stainless steel, grade 304

/pc.

Potential control to avoid surface discharges on the isCon® cable. Installation takes place after the first 1.5 metres.

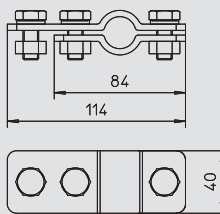

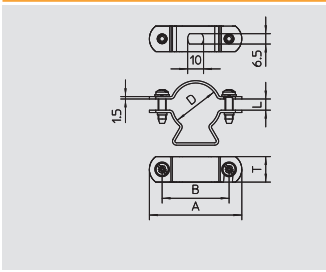

**VA cable bracket**

Type	Dimension D Ø mm	Pack. pcs	Weight kg/100 pcs.	Item No.
<b>isCon H VA</b>	23	50	2.850	<b>5408 05 6</b>
<b>isCon H 26 VA</b>	26	50	3.400	<b>5408 06 4</b>

V2A Stainless steel, grade 304

/pc.

Cable brackets for isCon® cable for mounting on roof/wall structures.

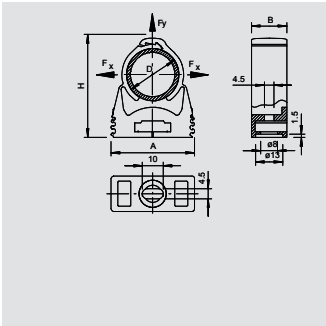

**starQuick cable bracket PA**



Type	Colour	Dimension D mm	Dimension A mm	Dimension B mm	Pack. pcs	Weight kg/100 pcs.	Item No.
<b>SQ-20 SW</b>	Jet black	23	29	17	50	0.848	<b>2146 16 4</b>
<b>SQ-25 LGR</b>	Light grey	26	40	17	50	0.970	<b>2146 20 7</b>

PP Polypropylene PA Polyamide

/100 pc.

Cable brackets for isCon® cables for mounting on the building structure. Can also be used in the first 1.5 m. Can be arranged next to each other and are made from a UV and weather-resistant polyamide.

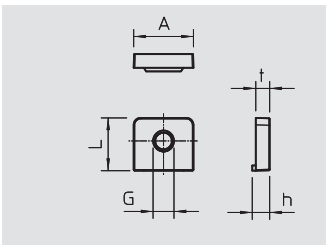

**starQuick nut M6**



Type	Colour	Thread	Dimension L mm	Dimension h mm	Dimension t mm	Pack. pcs	Weight kg/100 pcs.	Item No.
<b>SQ M6</b>	Light grey	M6	15	5	4	100	0.070	<b>2146 50 9</b>

PC Polycarbonate

/100 pc.

The starQuick nut was developed especially for the starQuick clip. Simply push into the intended opening of the starQuick. The starQuick nut is captive in the clip. Suitable for M6/M8 threads.

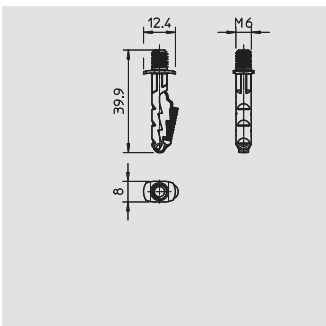

**starQuick anchor M6**



Type	Dowel Ø mm	Length mm	Bore hole Ø mm	Bore hole depth mm	Pack. pcs	Weight kg/100 pcs.	Item No.
<b>SQ PP 6</b>	6	30	6	35	50	0.100	<b>2351 70 6</b>

PA Polyamide

/100 pc.

Suitable for concrete, calcareous sandstone, brick or porous concrete masonry with interplay of the starQuick clip and starQuick nut.

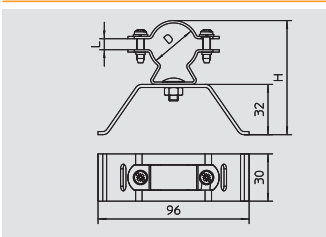

**VA cable bracket with tightening strap**

Type	Dimension D Ø mm	Pack. pcs	Weight kg/100 pcs.	Item No.
<b>isCon HS VA</b>	23	10	25.200	<b>5408 05 2</b>
<b>isCon HS 26 VA</b>	26	10	25.900	<b>5408 06 8</b>

V2A Stainless steel, grade 304

/pc.

Cable brackets for isCon® cable for pipe mounting on 2 m tightening strap.

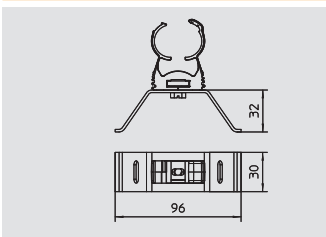

**PA cable bracket with tightening strap**

Type	Colour	Dimension Ø mm	Dimension D Ø mm	Pack. pcs	Weight kg/100 pcs.	Item No.
<b>isCon HS PA</b>	Black	Ø 23mm	23	10	23.100	<b>5408 05 4</b>
<b>isCon HS 26 PA</b>	Light grey	Ø 26mm	26	10	23.200	<b>5408 06 6</b>

PA Polyamide

/pc.

Cable brackets for isCon® cable for pipe mounting on 2 m tightening strap.

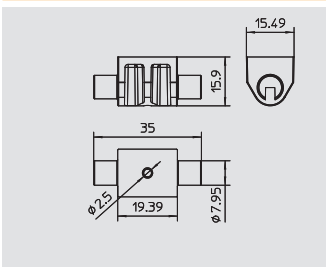

**Adapter for flat roof cable holder**

Type	Colour	Fit mm	Pack. pcs	Weight kg/100 pcs.	Item No.
<b>165 MBG UH</b>	Black	Rd 8	25	0.280	<b>5218 88 2</b>

PP Polypropylene

/pc.

Universal adapter with drillhole Ø 2.5 mm e.g. for OBO Golden Sprint screw, type 4758 4 x L (L = depending on application), for fastening to 165/MBG.



# OBO isCon® system



## M-Quick cable bracket PA

Type	Colour	Clamping range D mm	Pull-out value N	Pack. pcs	Weight kg/100 pcs.	Item No.
M-Quick M25 SW	Jet black	20-25	50	50	0.930	2153 78 7
M-Quick M32 LGR	Light grey	25-32	60	50	1.400	2153 73 4

PA Polyamide

Multi-quick metric.  
Simple fastening.  
Secure locking.  
Radial arrangement.  
Simplified storage.  
Universally applicable.

/100 pc.

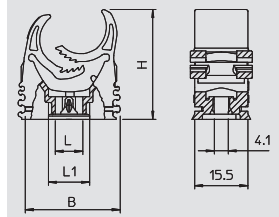

## VA roof cable holder, sloping roof

Type	Installation height mm	Dimension D Ø mm	Pack. pcs	Weight kg/100 pcs.	Item No.
isCon H280 VA	55	23	25	16.100	5408 04 7
isCon H280 26 VA	55	26	25	16.900	5408 07 4

V2A Stainless steel, grade 304

To route the isCon® cable on pitched roofs.

/pc.

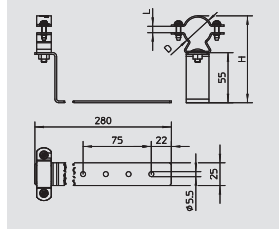

## PA roof cable holder, sloping roof

Type	Colour	Dimension mm	Dimension D Ø mm	Pack. pcs	Weight kg/100 pcs.	Item No.
isCon H280 PA	Black	280mm	23	25	13.950	5408 04 9
isCon H280 26 PA	Light grey	280mm	26	25	14.060	5408 07 2

PA Polyamide

To route the isCon® cable on pitched roofs.

/pc.

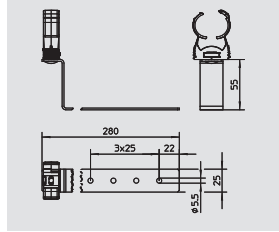

## Spacer

Type	Clamping range D mm	Pack. pcs	Weight kg/100 pcs.	Item No.
isCon DH	23-26	2	41.400	5408 04 3

GFK Fibre-glass-reinforced plastic

For stand-off installation of the isCon® cable in the area of the connection. Incl. reducing sleeve for mounting on FangFix concrete block 10 Kg.

/pc.

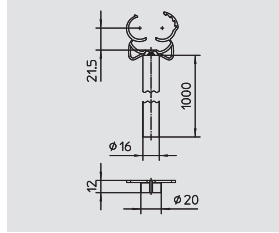

## Insulated interception rod for inner-routed isCon cable with side exit

Type	Dimension D Ø mm	Dimension A mm	Dimension H mm	Dimension B mm	Length mm	Materials combination	Pack. pcs	Weight kg/100 pcs.	Item No.
isFang IN-A 4000	50	1,325	1,500	1,000	4,000	Alu / GFK	1	535.000	5408 93 8
isFang IN-A 6000	50	3,325	1,500	1,000	6,000	Alu / GFK	1	835.000	5408 94 0

GFK Fibre-glass-reinforced plastic

- For installation of the OBO isCon® cable in the pipe
- With side cable outlet, fitting tripod stand type isFang 3B-A
- Inclusive connection element (type isCon IN connect)
- Inclusive potential connection (type isCon IN PAE)

/pc.

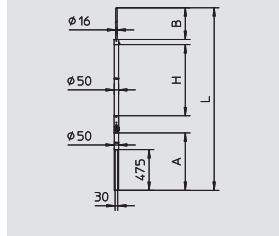

## isFang interception rod stand with side exit

Type	Dimension B mm	Dimension D Ø mm	Dimension L mm	Dimension H mm	Pack. pcs	Weight kg/100 pcs.	Item No.
isFang 3B-100-A	1,026	50	600	885	1	6,100.000	5408 93 0
isFang 3B-150-A	1,500	50	900	1,275	1	950.000	5408 93 2

V2A Stainless steel, grade 304

- Screwless installation of freestanding interception rods as well as insulated interception rods with 50 mm diameter
- e.g. for internal OBO isCon® cable
- Roof slope to max. 5 degrees
- Incl. Rd 8-10 crossbar for quick round conductor fastening
- Concrete plinths as well as threaded rods should be ordered separately

/pc.

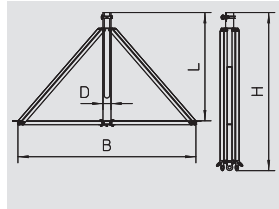

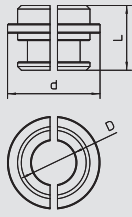

**Potential connection for installation in the insulated interception rod isFang IN**

Type	Dimension D Ø mm	Dimension d mm	Dimension L mm	Pack. pcs	Weight kg/100 pcs.	Item No.
<b>isCon IN PAE</b>	23	49.9	35	1	5.900	<b>5408 03 1</b>

**Al** Aluminium /pc.

- To avoid surface discharges on the isCon® cable
- Installation takes place after the first 1.5 metres in the insulated interception rod type isFang IN

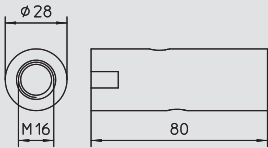

**Connection element for installation in the insulated interception rod isFang IN**

Type	Dimension D Ø mm	Thread	Pack. pcs	Weight kg/100 pcs.	Item No.
<b>isCon IN connect</b>	23	M16	1	27.800	<b>5408 02 4</b>

**V2A** Stainless steel, grade 304 /pc.

- Screw-on termination of the connection for the isCon® cable
- Connection and installation of the cable in the insulated interception rod
- Tested up to 150 kA (lightning protection Class II)

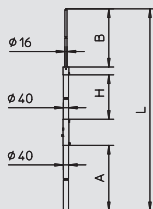

**Insulated interception rod**

Type	Dimension D Ø mm	Dimension A mm	Dimension H mm	Dimension B mm	Length mm	Materials combination	Pack. pcs	Weight kg/100 pcs.	Item No.
<b>isFang 4000 AL</b>	40	1,240	1,500	1,000	4,000	Alu / GFK	1	580.000	<b>5408 94 3</b>
<b>isFang 6000 AL</b>	40	3,340	1,500	1,000	6,000	Alu / GFK	1	600.000	<b>5408 94 7</b>
<b>isFang 4000</b>	40	1,240	1,500	1,000	4,000	V2A / GFK	1	680.000	<b>5408 94 2</b>
<b>isFang 6000</b>	40	3,340	1,500	1,000	6,000	V2A / GFK	1	1,260.000	<b>5408 94 6</b>

**GFK** Fibre-glass-reinforced plastic /pc.

Insulated support pipe for separate installation of interception units and fastening the OBO isCon® cable.

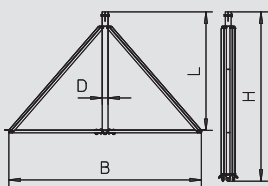

**isFang interception rod stand**

Type	Dimension B mm	Dimension D Ø mm	Dimension L mm	Dimension H mm	Pack. pcs	Weight kg/100 pcs.	Item No.
<b>isFang 3B-100 AL</b>	1,000	40	600	885	1	380.000	<b>5408 96 6</b>
<b>isFang 3B-150 AL</b>	1,500	40	900	1,275	1	560.000	<b>5408 96 7</b>
<b>isFang 3B-100</b>	1,000	40	600	885	1	620.000	<b>5408 96 8</b>
<b>isFang 3B-150</b>	1,500	40	900	1,275	1	950.000	<b>5408 96 9</b>

**V2A** Stainless steel, grade 304 **Al** Aluminium /pc.

Folding tripod stand for screwless installation of free-standing interception rods with a diameter of 40 mm, e.g. for OBO isCon® cable. Roof slope to max. 5 degrees. Incl. Rd 8-10 crossbar for rapid round conductor fastening. The concrete plinth and threaded rods are to be ordered separately.

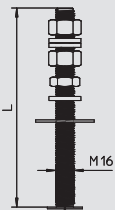

**isFang-3B threaded rod**

Type	Dimension L mm	Pack. pcs	Weight kg/100 pcs.	Item No.
<b>isFang 3B-G1</b>	270	3	48.000	<b>5408 97 1</b>
<b>isFang 3B-G2</b>	340	3	60.400	<b>5408 97 2</b>
<b>isFang 3B-G3</b>	430	3	76.600	<b>5408 97 3</b>

**V2A** Stainless steel, grade 304 /pc.

Threaded rod to fasten 1, 2 or 3 FangFix concrete bases with tripod stand. To mount the threaded rods, the edge protection must be drilled.

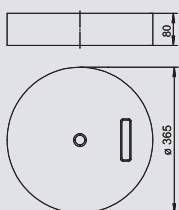

**Concrete block for FangFix-System 16 kg**

Type	Nominal size Ø mm	Pack. pcs	Weight kg/100 pcs.	Item No.
<b>F-FIX-S16</b>	365	1	1,700.000	<b>5403 22 7</b>

- 16 kg stone of Ø 365 mm, high level of stability
- Concrete, frost-resistant
- Stackable

/100 pc.



Insulated lightning protection and OBO isCon system

02\_TBS\_Masterkatalog\_Länder\_2012 / en / 29/05/2012 (LExport\_01433) / 29/05/2012

## Base for FangFix system 16 kg for mounting the isFang tripod



Type	Nominal size Ø	Dimension D	Pack.	Weight	Item No.
	mm	mm	pcs	kg/100 pcs.	
<b>F-FIX-B16 3B</b>	373	25	10		<b>5403 23 8</b>

PP Polypropylene

- Edge protection with through hole
- For mounting isFang-3B threaded rod and FangFix concrete block F-FIX-S16

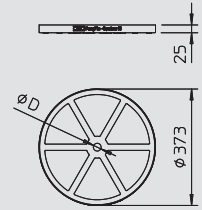

## Potential connection clip for mounting on isFang



Type	Fit	Pack.	Weight	Item No.
	mm	pcs	kg/100 pcs.	
<b>927 2 6-K</b>	3/8-4"	10	5.500	<b>5057 59 9</b>

V2A Stainless steel, grade 304

/100 pc.

Potential connection for isCon® cable for mounting on insulated interception rods of type isFang.

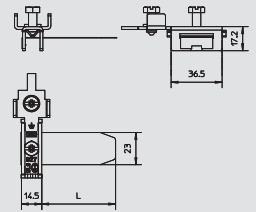

## Connection plate for one isCon® cable



Type	Dimension	Pack.	Weight	Item No.
		pcs	kg/100 pcs.	
<b>isCon AP1-16 VA</b>	16x8-10mm	1	27.400	<b>5408 02 6</b>

V2A Stainless steel, grade 304

/pc.

Connection plate to connect an isCon® cable with interception rod Ø 16 mm.

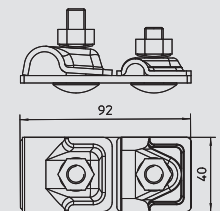

## Connection plate for two isCon® cables



Type	Dimension	Pack.	Weight	Item No.
		pcs	kg/100 pcs.	
<b>isCon AP2-16 VA</b>	16x8-10mm	1	39.500	<b>5408 02 8</b>

V2A Stainless steel, grade 304

/pc.

Connection plate to connect two isCon® cables with interception rod Ø 16 mm.

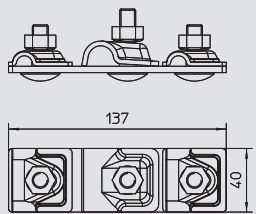

## Strip clip for fastening the isCon® cable to insulated interception rods



Type	Dimension	Max. bundle Ø	Minimum breaking load kN	Colour	Pack.	Weight	Item No.
	mm	mm			pcs	kg/100 pcs.	
<b>555 7.6x380 SWUV</b>	7.6 x 380	102	0.55	Black	100	0.606	<b>2332 78 4</b>

PA Polyamide

/100 pc.

For rapid fixing, UV and weather-resistant.

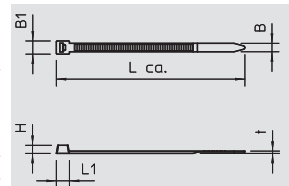

## Insulated interception rod for inner-routed isCon cable



Type	Dimension D	Dimension A	Dimension H	Dimension B	Length	Materials combination	Pack.	Weight	Item No.
	Ø mm	mm	mm	mm	mm		pcs	kg/100 pcs.	
<b>isFang IN 4000</b>	50	1,325	1,500	1,000	4,000	Alu / GFK	1	535.000	<b>5408 93 4</b>
<b>isFang IN 6000</b>	50	3,325	1,500	1,000	6,000	Alu / GFK	1	835.000	<b>5408 93 6</b>

GFK Fibre-glass-reinforced plastic

/pc.

- For installation of the OBO isCon® cable in the pipe
- For mounting on the building structure
- Inclusive connection element (type isCon IN connect)
- Inclusive potential connection (type isCon In PAE)

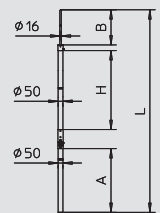

## isFang support for wall mounting, 15 mm spacing



Type	Dimension D	Dimension L	Pack.	Weight	Item No.
	Ø mm	mm	pcs	kg/100 pcs.	
<b>isFang TW30</b>	—	30	2	62.000	<b>5408 95 2</b>

V2A Stainless steel, grade 304

/pc.

Fastening clip to fasten the insulated support pipes on the structure to be protected or on the wall.

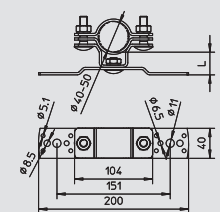



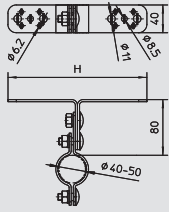

**isFang support for wall mounting, 80 mm spacing**

Type	Dimension D Ø mm	Dimension L mm	Pack. pcs	Weight kg/100 pcs.	Item No.
<b>isFang TW80</b>	–	80	2	63.000	<b>5408 95 0</b>

V2A Stainless steel, grade 304 /pc.  
Fastening clip to fasten the insulated support pipes on the structure to be protected or on the wall.

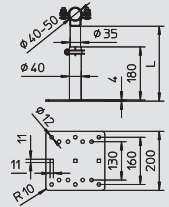

**isFang support for wall mounting, 200–300 mm spacing**

Type	Dimension D Ø mm	Dimension L mm	Pack. pcs	Weight kg/100 pcs.	Item No.
<b>isFang TW200</b>	–	300	2	230.000	<b>5408 95 4</b>

V2A Stainless steel, grade 304 /pc.  
Fastening clip to fasten the insulated support pipes on the structure to be protected or on the wall.

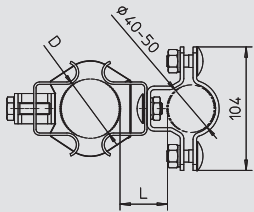

**isFang support for pipe mounting, Ø 50–300 mm**

Type	Dimension D Ø mm	Dimension L mm	Pack. pcs	Weight kg/100 pcs.	Item No.
<b>isFang TR100</b>	300	40	2	77.000	<b>5408 95 6</b>

V2A Stainless steel, grade 304 /pc.  
Tightening strap clip to fasten the insulated support pipes on the structure to be protected or for construction-side pipes of Ø 50–300mm.

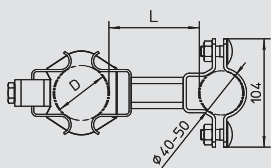

**isFang support for spaced pipe mounting, Ø 50–300 mm**

Type	Dimension D Ø mm	Dimension L mm	Pack. pcs	Weight kg/100 pcs.	Item No.
<b>isFang TR100 100</b>	300	100	2	95.500	<b>5408 95 5</b>
<b>isFang TR100 200</b>	300	200	2	121.000	<b>5408 95 7</b>
<b>isFang TR100 300</b>	300	300	2	146.000	<b>5408 95 9</b>

V2A Stainless steel, grade 304 /pc.  
Tightening strap clip to fasten the insulated support pipes on the structure to be protected or for construction-side pipes of Ø 50–300mm.

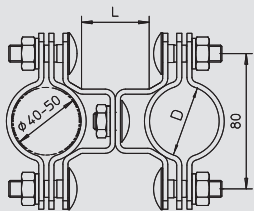

**isFang support for pipe mounting, Ø 40–50 mm**

Type	Dimension D Ø mm	Dimension L mm	Pack. pcs	Weight kg/100 pcs.	Item No.
<b>isFang TS40-50</b>	50	40	2	90.000	<b>5408 95 8</b>

V2A Stainless steel, grade 304 /pc.  
Fastening clip to fasten the insulated support pipes on the structure to be protected or for construction-side pipes of Ø 40–50mm.

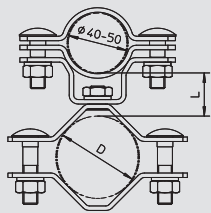

**isFang support for pipe mounting, Ø 50–60 mm**

Type	Dimension D Ø mm	Dimension L mm	Pack. pcs	Weight kg/100 pcs.	Item No.
<b>isFang TS50-60</b>	60	30	2	76.000	<b>5408 96 0</b>

V2A Stainless steel, grade 304 /pc.  
Fastening clip to fasten the insulated support pipes on the structure to be protected or for construction-side pipes of Ø 50–60mm.

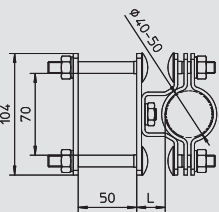

**isFang support for corner pipe mounting, 50 x 50 mm**

Type	Dimension D Ø mm	Dimension L mm	Pack. pcs	Weight kg/100 pcs.	Item No.
<b>isFang TS50x50</b>	–	30	2	82.000	<b>5408 96 4</b>

V2A Stainless steel, grade 304 /pc.  
Fastening clip to fasten the insulated support pipes on the structure to be protected or for construction-side corner pipes of 50x50mm.



02\_TBS\_Masterkatalog\_Länder\_2012 / en / 29/05/2012 (LLEExport\_01433) / 29/05/2012

Insulated lightning protection and OBO isCon system



## Information panel

Type	Pack.	Weight	Item No.
	pcs	kg/100 pcs.	
<b>isCon HWS</b>	1	2.000	<b>5408 05 8</b>

**PS** Polystyrene /pc.

Label: "NOTE! Insulated lightning protection with the OBO isCon® system. Only a lightning protection specialist may carry out changes"

- To label the lightning protection system
- Self-adhesive and with 4 fastening holes  $\varnothing$  6.5 mm

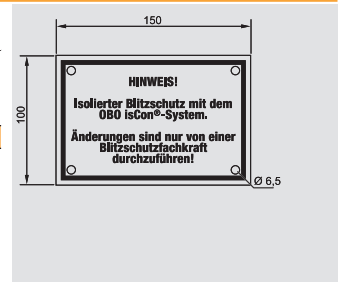

## Cleaning cloth

Type	Width	Length	Pack.	Weight	Item No.
	mm	mm	pcs	kg/100 pcs.	
<b>isCon EPPA 004</b>	140	200	50	0.420	<b>5408 06 0</b>

**Z-PP-P** Cellulose-polypropylene paper /100 pc.



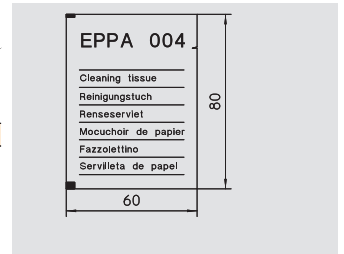

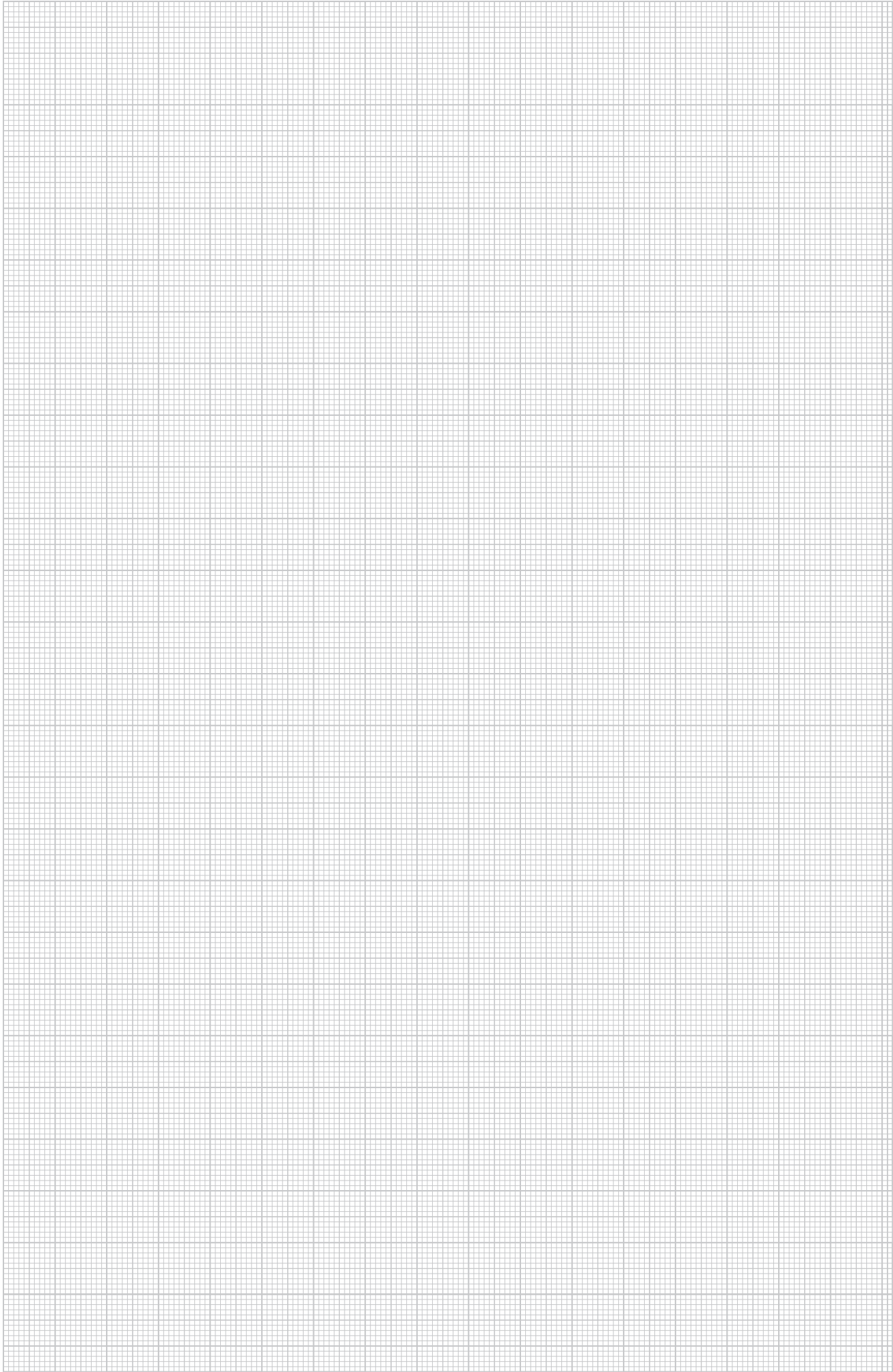
- Cellulose polypropylene paper with abrasive sections, folded multiple times
- Doused with 2.8 ml impregnation solution
- For cleaning the external jacket of the OBO isCon® cable







## Directories

	Alphabetical table of contents	398
	Numeric directory	404
	Type listing	408
	Terms and conditions of sale and delivery	419



# Alphabetical table of contents

## A

Accessories for series terminal, 280  
Adapter for flat roof cable holder, 390  
Adjustable insulating beam – pipe, 386  
Adjustable insulating beam – wall, 386  
Angler spreading anchor, 378  
Articulated connector, 384

## B

Base for FangFix Junior, 332  
Base for FangFix system 10 kg, 334, 385  
Base for FangFix system 16 kg, 333, 384  
Base for FangFix system 16 kg for mounting the, 338, 392  
isFang tripod  
Base plate, 351  
Base, Multibase, 165, 196, 205  
Base, Multibase + NPE, 165, 196, 205  
Base, Multibase + NPE with fuse monitoring, 166, 197, 206  
Base, Multibase + NPE with remote signalling, 165, 196, 205  
Base, Multibase with acoustic signalling, 166, 197, 206  
Base, Multibase with fuse monitoring, 165, 196, 205  
Base, Multibase with remote signalling, 165, 196, 205  
Basic protection for 4-wire information technology, 252  
systems with RJ45  
Basic protection for two-core systems with HF, 265  
applications 120 V  
Bi-metal roof gutter clamp for all bead thicknesses, 366  
Bi-metal separating piece for Rd 8–10 and FL 30 mm, 373  
Bi-metal separating piece for Rd 8–10 and FL 30–40, 374  
mm  
Bonding base, 348  
Bonding base including industrial bonding pad, 348  
BP earthing rod, 312  
BP earthing rod with copper sheath, 313  
Bridging cable, 369

## C

Cable bracket for flat conductor, 324  
Cable bracket for Rd 8–10 and FL 30, 324  
Cable bracket with crossbar FL 30 mm, with round, 350  
pin  
Cable bracket with crossbar FL, 30 mm mounting, 350  
height  
Cable bracket with crossbar Rd 8–10 mm, 349  
Cable bracket with crossbar Rd 8–10 mm, with, 350  
square pin  
Cable bracket with crossbar Rd 8–10 mm, with wood, 351  
screw thread  
Cable bracket with hinged crossbar Rd 8–10 mm, 349  
Cable bracket with hinged crossbar Rd 8–10, 30 mm, 349-350  
mounting height  
Cable bracket, Rd 8–10 mm with bonding base, 348  
Card reader PCS-CS..., 293  
Clamp lock for strip earthing clip, 303  
Clamp clips for screen connection, 306  
Clamping block for Rd 16 mm, 353  
Clamping block for Rd 8-10 mm, 352  
Clamping shoe, 367  
Clip branch terminal, 306  
Closed spark gap with lightning current carrying, 288  
capability  
Coaxial protection device for 7/16 connection:, 247  
male/female  
Coaxial protection device for BNC connection:, 245  
female/female  
Coaxial protection device for BNC connection:, 245  
male/female  
Coaxial protection device for BNC connection:, 246  
male/male  
Coaxial protection device for F connection:, 247  
female/female  
Coaxial protection device for F connection:, 247  
male/female

## C

Coaxial protection device for N connection:, 246  
female/female  
Coaxial protection device for N connection:, 246  
male/female  
Coaxial protection device for SAT and cable, 248  
multiswitch  
Coaxial protection device for SMA connection:, 247  
female/female  
Coaxial protection device for TNC connection:, 246  
male/female  
Coaxial protection devices for S-UHF connection:, 245  
female/female  
Coaxial protection devices for S-UHF connection:, 245  
male/female  
CombiController V50 base, 152  
CombiController V50 base with remote signalling, 152  
Combination arrester for 10Base2-/10Base5, 250  
networks  
Combination arrester for 4-wire information, 252  
technology systems with RJ45  
Combination arrester upper part, 142  
Combination arrester upper part 280 V, 163  
Combination arrester upper part 320 V, 163  
Combination arrester upper part 385 V, 163  
Combination arrester upper part 150 V, 163  
Combination arrester upper part 150 V, 151  
Combination arrester upper part 280 V, 151  
Combination arrester, 1-pole, 137, 155, 158, 162  
Combination arrester, 1-pole + NPE, 154, 156  
Combination arrester, 1-pole + NPE with remote, 157  
signalling  
Combination arrester, 1-pole NPE, 136, 156  
Combination arrester, 1-pole with function display, 137  
Combination arrester, 2-pole, 155, 158, 162  
Combination arrester, 2-pole + NPE, 156  
Combination arrester, 3-pole, 137, 158, 162  
Combination arrester, 3-pole + NPE, 136, 154, 156, 161  
Combination arrester, 3-pole + NPE with function, 136  
display  
Combination arrester, 3-pole + NPE with remote, 157, 161  
signalling  
Combination arrester, 3-pole + NPE, with acoustic, 157, 161  
signalling  
Combination arrester, 3-pole with function display, 137  
Combination arrester, 3-pole with remote signalling, 159  
Combination arrester, 3-pole, with acoustic signalling, 159  
Combination arrester, 4-pole, 158, 162  
Combination arrester, 4-pole in housing with remote, 160  
signalling  
Combination arrester, 4-pole with remote signalling, 159  
Combination arrester, 4-pole, with acoustic signalling, 159  
Combination arrester, 4-pole, with voltage monitoring, 160  
Combination protection device for ISDN, 237  
Combination protection device for ISDN and DSL, 237  
systems  
Combination protection device for ISDN bus side, 239  
Combination protection device for ISDN RJ11, 238  
Combination protection device for ISDN RJ45, 238  
Combination protection for two-core systems with HF, 265  
applications 24 V  
Combination protection for two-core systems with HF, 265  
applications 5 V  
Complete photovoltaic block V20, 1000 V DC, 223  
Complete photovoltaic block V20, 1000 V DC with IR, 223  
Complete photovoltaic block V20, 600 V DC, 222  
Complete photovoltaic block V20, 600 V DC with IR, 222  
Complete photovoltaic block V25, 900 V DC, 221  
Complete photovoltaic block V25, 900 V DC with IR, 221  
Complete photovoltaic block V50, 600 V DC, 220  
Complete photovoltaic block V50, 600 V DC with IR, 220  
Concrete block for FangFix system 10 kg, 334, 384  
Concrete block for FangFix-System 16 kg, 333, 338, 384, 392  
Connecting bridge, 143

**C**

Connecting bridge for V10 Compact 200 mm, 201  
 Connecting bridge for V10 Compact 400 mm, 201  
 Connecting bridge, Multibase base, 164  
 Connection and bridging component, 369  
 Connection and end piece, 358  
 Connection and end piece with connector, 358  
 Connection and end piece with connector and, 358  
 pressure trough  
 Connection and end piece, DIN version, 358  
 Connection and expansion strip, 369  
 Connection clip, 374  
 Connection clip for earthing rod on flat conductor, 318  
 Connection clip for earthing rod or cables, 318  
 Connection clip for earthing rod to round cables Rd, 318  
 8-10  
 Connection clip for earthing rod, universal, 318  
 Connection component, 369  
 Connection element, 388  
 Connection element for installation in the insulated, 391  
 interception rod isFang IN  
 Connection joint, 384  
 Connection piece, 383  
 Connection plate for one isCon® cable, 392  
 Connection plate for two isCon® cables, 392  
 Connection strap for Parex spark gap, 288  
 Connection terminal for reinforced steels, 322  
 Connection terminal for round cable, 322  
 Connection terminal to 14 mm, 363  
 Connection terminal, equipotential bonding, Rd 16, 306, 368  
 mm  
 Connection terminal, equipotential bonding, Rd 8-10, 305, 367  
 mm  
 Connector Rd 8-10 mm, double, 356  
 Connector Rd 8-10 mm, single, 356  
 Connector Rd 8-10 mm, triple, 357  
 Connector, Rd 8-10 mm with M10 thread, 356  
 Connector, Rd 8-10 mm with pressure trough, 357  
 Connector, Rd 8-10 mm, double, with pressure, 357  
 trough  
 Construction clamp to 20 mm, 363  
 Contact strip for 1801 VDE, 297  
 Copper bridges with step width 17.6 mm, 206  
 Copper bridges with step width 53.4 mm, 206  
 Copper flat conductor, 310  
 Cover for BigBar equipotential bonding rail, 301  
 Cover hood for 1801 VDE, 297  
 Cover hood for 1809, 298  
 Crossbar for equipotential bonding rail, 301  
 Crossbar for Rd 8-10 mm, 351  
 Crossbar, round cables and interception rods 16 mm, 353  
 Cross-connector for flat conductor, 319  
 Cross-connector for flat conductor, with intermediate, 319  
 plate  
 Cross-connector for flat conductors and round cables, 321  
 Cross-connector for Rd 8-10 x Rd 16 mm, 362  
 Cross-connector for round cables and flat conductors, 360  
 Cross-connector for round cables and flat conductors, 360  
 DIN  
 Cross-connector for round cables Rd 8-10, 319  
 Cross-connector for round cables Rd 8-10 x Rd 16, 320  
 Cross-connector Rd 8-10 mm, 361  
 Cross-connector Rd 8-10 mm, wide version, 361  
 Cross-connector with intermediate plate for Rd 8-10, 361  
 mm  
 Cross-connector with intermediate plate for Rd 8-10, 361-362  
 mm, wide version  
 Cross-connector with intermediate plate for Rd 8-10, 362  
 x Rd 16 mm  
 Cross-connector with intermediate plate for round, 320  
 cables, Rd 8-10

**C**

Cross-connector with intermediate plate for round, 320  
 cables, Rd 8-10 x Rd 16

**D**

Data cable protection device for coaxial TV / camera, 251  
 systems  
 Decoupling inductivity, 143  
 Diagonal clamp, 321  
 Diagonal clamp with bolt, 321  
 DIN cross-connector for flat conductor, 319  
 DIN cross-connector for flat conductor, with, 319  
 intermediate plate  
 Directional irons, 378  
 DK connector, 383  
 Double connection terminal, equipotential bonding,, 368  
 Rd 8-10 mm  
 Downspout clip, 370  
 Downspout clip for routing Rd 8-10 mm behind pipe, 370-371

**E**

Earth connection terminal for round cable and flat, 306  
 conductor  
 Earth entry rod with separating piece and connector, 316, 375  
 Earth entry rod, tapered and partially insulated, 316, 375  
 Earthing clip, type 925, 304  
 Earthing clip, type 942, 304  
 Earthing clip, type 952, 305  
 Earthing connection block, 323  
 Earthing fixed point, 322  
 Earthing plate, 317  
 Earthing rod for standard applications, 312  
 Earthing screw with fastening thread, 306  
 Earthing strap, type 950, 304  
 Earthing terminal for cables and flat conductors, 306  
 Earthing terminal for fastening on earthing strap, 304  
 Earthing terminal type 951, 305  
 Empty housing for arrestors, 164  
 End piece, 322-323, 368, 383  
 Equipotential bonding bar for bathroom, 299  
 Equipotential bonding rail BigBar for industrial, 301  
 application  
 Equipotential bonding rail for indoors, VDE-tested, 296  
 Equipotential bonding rail for outside installation, 300  
 Equipotential bonding rail for small systems, 298  
 Equipotential bonding rail with metal base plate, 298  
 Equipotential bonding rail with plastic base plate, 297  
 Equipotential bonding rail, simple version, 299  
 Equipotential bonding rail, solid version, 298  
 Expansion piece, 323, 369  
 Explosion-proof, closed spark gap, 288  
 Extension, 384

**F**

FangFix reducing sleeve, 384  
 Fastening bolt, 385  
 Fastening plate, 385  
 Fastening set for hat profile rail, 251  
 Fine power protection / adapter with cold device, 211  
 connector  
 Fine power protection / dado duct installation Modul, 213  
 45  
 Fine power protection / socket bar, 211  
 Fine power protection for all installation systems, 212  
 Fine power protection for through wiring, 212  
 Fine power protection with holder for GB2 and GB3, 212  
 mounting boxes  
 Fine protection device for ISDN RJ11, 238  
 Fine protection device for ISDN RJ45, 238  
 Fine protection for 10Base2-/10Base5 networks, 250  
 Fine protection for 15-pin RS232 interface, 255

## Alphabetical table of contents

### F

Fine protection for 25-pin RS232 interface, 255  
Fine protection for 25-pin RS485 interface, 256  
Fine protection for 4-wire information technology, 253 systems RJ45  
Fine protection for 4-wire information technology, 252 systems with RJ45  
Fine protection for 8-wire information technology, 253 systems RJ45  
Fine protection for 9-pin RS232 interface, 255  
Fine protection for 9-pin RS485 interface, 256  
Fine protection for Ethernet networks (Class D/CAT, 250 5)  
Fine protection for RS232 with screwless terminals, 257  
Fine protection for RS485 with screwless terminals, 257  
FineController for ISDN telephone systems and, 211 terminals  
FineController for protective contact socket, 210  
FineController for SAT systems and receivers, 210  
FineController for telephone systems and terminals, 210  
FineController for telephone systems with RJ11, 211  
FineController for video, TV and HiFi systems, 210  
Flat conductor adapter for roof cable holder, type, 345 165/MBG  
Flat conductor terminal from FL 30 for 1801 VDE, 297  
Flat conductor terminal to FL 30 for 1801 VDE, 296  
Flat conductor, copper, 330  
Flat lead, 377  
Fold fastening, 385  
Folding and construction clamp, 10–20 mm, 362  
Folding clamp and connection terminal up to 10 mm, 365 plate thickness  
Folding clamp Rd 8-10 up to 10 mm plate thickness, 363-364  
Folding clamp up to 10 mm plate thickness, 363-364  
Folding clamp up to 5 mm plate thickness, 364

### G

Galvanised steel flat conductor, 310  
Galvanised steel flat conductor for earth, 330  
Gutter clamp for all bead thicknesses, 365-366  
Gutter clamp for bead thickness 15–22 mm, 366  
Gutter clamp RK-FIX, 365

### H

Hammer insert for LightEarth earthing rod, 315  
Hammer insert, type 2500, for earthing rods ST, BP, 314 and OMEX  
Hammer insert, type 2510, for earthing rods ST, BP, 314 and OMEX  
Hammer insert, type 2520, for earthing rods ST, BP, 314 and OMEX  
Hammer insert, type 2530, for earthing rods ST, BP, 314 and OMEX  
Hammer insert, type 2531, for earthing rods ST, BP, 314 and OMEX  
Hammer insert, type 2535, for earthing rods ST, BP, 315 and OMEX  
Hammer insert, type 2536, for earthing rods ST, BP, 315 and OMEX  
Hinge crossbar for FL 30 mm, 351  
Hinge crossbar for Rd 8-10 mm, 351  
Holder for installation in GB2 and GB3 mounting, 212 boxes  
Holder, V support, 385

### I

Impact head for earthing rods ST, BP and OMEX, 314  
Impact head for LightEarth earthing rod, 313  
Impact point for LightEarth earthing rod, 313  
Impact point for OMEX earthing rod, 313  
Impact point for ST and BP earthing rod, 313  
Inspection door, 376  
Installation strip for strip earthing clip, 303

### I

Insulated interception rod, 337, 391  
Insulated interception rod for inner-routed isCon cable, 338, 393  
Insulated interception rod for inner-routed isCon cable, 337, 390 with side exit  
Insulated lightning protection set, 3-corner fastening, 382  
Insulated lightning protection set, IR fastening, 382  
Insulated lightning protection set, V fastening, 382  
Insulated lightning protection set, VRS fastening, 382  
Insulated spacer, 387  
Insulating rod, 382  
Insulation removal pliers, 388  
Interception rod for FangFix-Junior, 332  
Interception rod holder for ridge tiles, 336  
Interception rod holder for sloping roof, 335  
Interception rod, one end rounded, 334  
Interception rod, one end rounded with connection, 334 strap  
Interception tip, 332, 386  
Interception/earth entry rod with connection tabs, 316, 335, 375  
Interception/earth entry rod with connection tabs and, 335 connector  
Interception/earth entry rod, rounded-off on both, 315, 332-333, 375 sides  
isCon® arrestor, 388  
isCon® arrestor in light grey, 388  
isFang interception rod, 337  
isFang interception rod stand, 337, 391  
isFang interception rod stand with side exit, 337, 391  
isFang support for corner pipe mounting, 50 x 50 mm, 339  
isFang support for pipe mounting,  $\varnothing$  40–50 mm, 339, 394  
isFang support for pipe mounting,  $\varnothing$  50–300 mm, 339, 393  
isFang support for pipe mounting,  $\varnothing$  50–60 mm, 339  
isFang support for spaced pipe mounting,  $\varnothing$  50–300, 339, 394 mm  
isFang support for wall mounting, 15 mm spacing, 338, 393  
isFang support for wall mounting, 200–300 mm, 338, 393 spacing  
isFang support for wall mounting, 80 mm spacing, 338, 393  
isFang-3B threaded rod, 338, 392  
ISOLAB measuring system arrestor tester, 292

### K

K connector, 383

### L

LightEarth earthing rod, 312  
Lightning arrestor/combination arrestor base, 143  
Lightning current and surge arrestor, 1-pole + NPE, 148  
Lightning current and surge arrestor, 1-pole + NPE, 149 with remote signalling  
Lightning current and surge arrestor, 2-pole + NPE, 148  
Lightning current and surge arrestor, 3-pole, 150  
Lightning current and surge arrestor, 3-pole + NPE, 148  
Lightning current and surge arrestor, 3-pole + NPE, 149 with remote signalling  
Lightning current and surge arrestor, 3-pole with, 150 remote signalling  
Lightning current and surge arrestor, 4-pole, 150  
Lightning current and surge arrestor, 4-pole with, 150 remote signalling  
Lightning current arrestor, 1-pole, 141  
Lightning current arrestor, 1-pole NPE, 140  
Lightning current arrestor, 1-pole with function display, 141  
Lightning current arrestor, 3-pole, 141  
Lightning current arrestor, 3-pole + NPE, 140  
LSA-Plus technology / LSA basic protection, 241  
LSA-Plus technology / LSA connection strip, 241  
LSA-Plus technology / LSA earthing rail for LSA-BF, 242  
LSA-Plus technology / LSA earthing strip, 241  
LSA-Plus technology / LSA installation trough, 242  
LSA-Plus technology / LSA separating strip, 241  
LSA-Plus technology / LSA simple tool, 243



**L**

LSA-Plus technology / protective housing, 243  
 LSA-Plus technology/LSA basic and fine protection, 242

**M**

Magnetic card and holder, 376  
 Magnetic card and holder MK-B, 293  
 Magnetic card holder, 377  
 Magnetic card holder PCS-H, 293  
 Magnetic card PCS, 293, 376  
 Magnetic card reader, 377  
 Malleable iron separating piece, 374  
 MCR protection for 2-pin for power supply with leak, 217, 263  
 current-free remote signalling, 110 V AC/DC  
 MCR protection for 2-pin for power supply with leak, 217, 263  
 current-free remote signalling, 230 V AC/DC  
 MCR protection for 2-pin for power supply with leak, 217, 263  
 current-free remote signalling, 24 V AC/DC  
 MCR protection for 2-pin for power supply with, 216, 262  
 remote signalling, 110 V AC/DC  
 MCR protection for 2-pin for power supply with, 261  
 remote signalling, 12 V AC/DC  
 MCR protection for 2-pin for power supply with, 216, 262  
 remote signalling, 230 V AC  
 MCR protection for 2-pin for power supply with, 216, 261  
 remote signalling, 24 V AC/DC  
 MCR protection for 2-pin for power supply with, 261  
 remote signalling, 48 V AC/DC  
 MCR protection for 2-pin for power supply with, 262  
 remote signalling, 60 V AC  
 MCR protection for 2-pin for power supply, 110 V, 215, 260  
 MCR protection for 2-pin for power supply, 12 V, 214, 259  
 MCR protection for 2-pin for power supply, 230 V, 215, 260  
 MCR protection for 2-pin for power supply, 24 V, 214, 259  
 MCR protection for 2-pin for power supply, 48 V, 214, 259  
 MCR protection for 2-pin for power supply, 60 V, 214, 259  
 MCR protection for explosive areas, 2-pole, 24 V, 282  
 MCR protection for explosive areas, 3-pole, 24 V, 282  
 Medium and fine protection for two-core systems 110, 267, 270,  
 V 272  
 Medium and fine protection for two-core systems 12, 266, 269,  
 V 271  
 Medium and fine protection for two-core systems 24, 266, 268-  
 V 269, 271  
 Medium and fine protection for two-core systems 48, 266, 269,  
 V 271  
 Medium and fine protection for two-core systems 5 V, 266, 268-  
 269, 271  
 Medium and fine protection for two-core systems 60, 270  
 V  
 M-Quick cable bracket PA, 390  
 Multi-Adapter, 386  
 Multibase MB25 base, 191  
 Multibase MB25 base with remote signalling, 191  
 Mushroom-shaped interceptor with connectors, 336

**N**

Number plates, 326, 374

**O**

OMEX earthing rod, 313

**P**

PA cable bracket with tightening strap, 389  
 PA roof cable holder, sloping roof, 390  
 Parallel clamp, 322  
 Parallel connector Rd 8 mm, M10 x 30, 359  
 Parallel connector Rd 8–10 mm, M6 x 20, 359  
 Parallel connector Rd 8–10 mm, M8 x 25, 358  
 Photovoltaic housing 600 V DC with connection, 227  
 terminals with IR  
 Photovoltaic housing 900 V DC with connection, 227  
 terminals with IR

**P**

Photovoltaic housing for inverter with 2 MPP trackers,, 224  
 type 1+2, 900 V DC  
 Photovoltaic housing for inverter with 2 MPP trackers,, 224  
 type 2, 1000 V DC  
 Photovoltaic housing for inverter with 2 MPP trackers,, 230  
 unequipped  
 Photovoltaic housing for inverter with 3 MPP trackers,, 224  
 type 1+2, 900 V DC  
 Photovoltaic housing for inverter with 3 MPP trackers,, 224  
 type 2, 1000 V DC  
 Photovoltaic housing for inverter with 3 MPP trackers,, 230  
 unequipped  
 Photovoltaic housing with 4 fuses, 225  
 Photovoltaic housing with 6 fuses, 225  
 Photovoltaic housing with connection terminals, type, 226  
 1+2, 600 V DC  
 Photovoltaic housing with connection terminals, type, 226  
 1+2, 900 V DC  
 Photovoltaic housing with connection terminals, type, 226  
 2, 1000 V DC  
 Photovoltaic housing with connection terminals,, 230  
 unequipped  
 Photovoltaic housing with MC 4 connector,, 230  
 unequipped  
 Photovoltaic housing with V-Tec entry, 228  
 Photovoltaic system solution, type 1+2, with MC, 229  
 connector, 600 V DC  
 Photovoltaic system solution, type 1+2, with MC, 229  
 connector, 900 V DC  
 Photovoltaic system solution, type 2, with MC, 229  
 connector, 1000 V DC  
 Photovoltaic system solution, type 2, with MC, 229  
 connector, 600 V DC  
 Photovoltaic upper part– lightning and surge arrestors, 231  
 Photovoltaic upper part– surge arrestors, 231  
 Photovoltaic upper part – lightning and surge, 231  
 arrestors  
 Photovoltaic upper part – surge arrestors, 231  
 Pipe clamp, 371  
 Pipe fastening, 385  
 Plastic corrosion protection strip, 326, 377  
 Potential and earth connection block, 302  
 Potential connection, 388  
 Potential connection clip for mounting on isFang, 392  
 Potential connection for installation in the insulated, 391  
 interception rod isFang IN  
 Profile earthing rod connection with connecting lug, 316  
 Profile earthing rod connection with round cable lug, 317  
 Profile rail, 306  
 Profile earthing rod connection with strip steel lug, 316  
 Protection package, SAT applications, 207  
 Protection package, telecommunications, 207  
 Protection package, TV, 207  
 Protection set MCD + V20 1-pole + NPE, 167  
 Protection set MCD + V20 3-pole, 168  
 Protection set MCD + V20 3-pole + NPE, 167  
 Protection set MCD + V20 3-pole + NPE with remote, 167  
 signalling  
 Protection set MCD + V20 3-pole with remote, 168  
 signalling  
 Protection set MCD + V20, leakage current-free, 3-, 170  
 pole  
 Protection set MCD + V20, leakage current-free, 3-, 169  
 pole + NPE  
 Protection set MCD + V20, leakage current-free, 3-, 169  
 pole + NPE with remote signalling  
 Protection set MCD + V20, leakage current-free, 3-, 170  
 pole with remote signalling  
 Protective spark gap, 289  
 PV base, 2-pole in Y circuit, 232  
 PV base, 2-pole in Y circuit with remote signalling, 232  
 PV base, 3-pole in Y circuit, 232  
 PV base, 3-pole in Y circuit with remote signalling, 232

## Alphabetical table of contents

### R

Rail stands for 1801 VDE, 297  
Remote signalling replacement connector for, 164, 197  
Multibase  
Replacement connector for VF remote signalling, 280  
Ridge conductor holder with tensioning spring, 340  
Rod clamp, 374  
Rod holder, 386  
Rod holder for 16 mm interception and earth entry, 352  
rods  
Rod holder for 16 mm interception and earth entry, 353  
rods, with square pin  
Rod holder for 16 mm interception and earth, 353  
entry rods, with screw and anchor  
Rod holder for 20 mm rods, 353-354  
Roof cable holder for flat roofs, 345  
Roof cable holder for flat roofs, plastic sleeve, 345  
Roof cable holder for flat roofs, recyclable, 346  
Roof cable holder for flat roofs, with increased base, 345  
section  
Roof cable holder for flat roofs, with raised cable, 346  
bracket  
Roof cable holder for flat roofs, without base, 345  
Roof cable holder for ridge tiles with M8 threaded, 341  
bolts  
Roof cable holder for ridge tiles, 180–240 mm, Rd, 341  
8–10  
Roof cable holder for ridge tiles, 185–260 mm, Rd 8, 340  
Roof cable holder for ridge tiles, 185–260 mm, Rd, 340-341  
8–10  
Roof cable holder for slated roofs with M8 threaded, 344  
bolts  
Roof cable holder for slated roofs, crimped, Rd 8, 342-343  
Roof cable holder for slated roofs, crimped, Rd 8–10, 343  
Roof cable holder for slated roofs, Rd 8, 343  
Roof cable holder for slated roofs, Rd 8–10, 343  
Roof cable holder for tiled and slated roofs, 74 mm, 344  
height  
Roof cable holder for tiled and slated roofs, Rd 8–10, 343  
Roof cable holder for tiled roofs, angled, flexible, Rd, 342  
8  
Roof cable holder for tiled roofs, angled, Rd 8, 342  
Roof cable holder for tiled roofs, angled, Rd 8–10, 342  
Roof cable holder for tiled roofs, Rd 8, 341  
Roof cable holder for tiled roofs, Rd 8–10, 341-342  
Roof cable holder for tiled, slated and corrugated, 344  
roofs, Rd 8  
Roof cable holder for tiled, slated and corrugated, 344  
roofs, Rd 8–10  
Roof cable holder for tiled, slated and corrugated, 344  
roofs, with cable bracket  
Roof cable holder for tiled, slated and corrugated, 344  
roofs, with crossbar  
Roof cable holder, 55 mm, suitable for bonding, 346  
straight to flat roofs  
Roof cable holder, suitable for bonding straight to flat, 346  
roofs  
Roof gutter clamp for all bead thicknesses, 366  
Roof penetration, 336  
Round cable terminal from 25 mm<sup>2</sup> for 1801 VDE, 296  
Round cable terminal to 25 mm<sup>2</sup> for 1801 VDE, 296  
Round cable, aluminium, 311, 331  
Round cable, aluminium with PVC sheathing, 331  
Round cable, aluminium, with PVC sheathing, 311  
Round cable, copper, 311, 331  
Round cable, galvanised steel, 310, 330  
Round cable, galvanised steel with PVC jacketing, 310, 330  
Round cable, stainless steel, 311, 331

### S

Screw-in anchor with M6 thread, 378  
Screw-in anchor with M8 thread, 378  
Screwless cable bracket for Rd 8 mm, fastening with, 347  
screw and anchor

### S

Screwless cable bracket for Rd 8 mm, through-way Ø, 347  
5 mm  
Screwless cable bracket for Rd 8 mm, through-way Ø, 347  
7 mm  
Screwless cable bracket, raised construction type, for, 347  
Rd 8 mm, through-way Ø 5 mm  
Separating piece for Rd 8–10 and FL 30 mm, 373  
Separating piece for Rd 8–10 and FL 30–40 mm, 373  
Separating piece, closed, 372  
Separating piece, open, 372  
Series protection device, 2-pole, 12 V version, 278  
Series protection device, 2-pole, 24 V version, 275, 279  
Series protection device, 2-pole, 48 V version, 276  
Series protection device, 2-pole, 5 V version, 274  
Series protection device, 3-pole, 24 V version, 275  
Series protection device, 3-pole, 48 V version, 276  
Series protection device, 3-pole, 5 V version, 274  
Series protection device, 4-pole, 12 V version, 278  
Series protection device, 4-pole, 24 V version, 275, 279  
Series protection device, 4-pole, 24 V version, Ex-, 284  
tested  
Series protection device, 4-pole, 48 V version, 276  
Series protection device, 4-pole, 48 V version, Ex-, 284  
tested  
Series protection device, 4-pole, 5 V version, 274, 277  
Series protection device, 4-pole, 5 V version, Ex-, 284  
tested  
Shock Guard for Multibase base, 164  
Shock Guard locking, 206  
Snow catching grate clamp, 367  
Spacer, 323, 390  
Spacer clip for flat conductor with fastening hole Ø, 324  
6.5  
Spacer clip for flat conductor, with fastening hole Ø 7, 324  
Spacer clip for flat conductor, with polyamide base, 324  
Spacer clip for flat conductor, with square pin, 325  
Spacer clip for flat conductor, with steel spreading, 325  
anchor Ø 10  
Spacer clip for flat conductor, with threaded, 324  
connection M6  
Spacer clip for flat conductor, with wood screw and, 325  
spacer  
Spare blade, 388  
Spark gap / surge voltage protection for coupling, 289  
earthing systems  
Stainless steel flat conductor, 310, 330  
Stand 16 kg with female thread, 335, 383  
Stand 6.9 kg with female thread, 335, 383  
Stand for FangFix Junior system, 332  
Stand for FangFix system 10 kg, 333  
Stand for FangFix system 16 kg, 333  
starQuick anchor M6, 389  
starQuick cable bracket PA, 389  
starQuick nut M6, 389  
Straight connector Rd 8 mm, 359  
Straight connector Rd 8–10 mm, 359  
Strip clip for fastening the isCon® cable to insulated, 393  
interception rods  
Strip earthing clip VA, 303  
Strip earthing clip, nickel-plated, 303  
Strip steel crimp, 326  
Surge arrester Compact 150 V, 200  
Surge arrester Compact 280 V, 200  
Surge arrester Compact 385 V, 200  
Surge arrester Compact with acoustic signalling, 200  
Surge arrester, 1-pole, 178, 181, 186, 188  
Surge arrester, 1-pole + NPE, 176, 179, 185, 202  
Surge arrester, 1-pole + NPE with remote signalling, 180  
Surge arrester, 1-pole NPE, 179, 195  
Surge arrester, 1-pole with remote signalling, 182  
Surge arrester, 1-pole, leakage current-free, 192  
Surge arrester, 2-pole, 178, 181, 186, 188

## S

Surge arrester, 2-pole + NPE, 176, 179  
 Surge arrester, 2-pole + NPE with remote signalling, 177, 180  
 Surge arrester, 2-pole with remote signalling, 182, 189  
 Surge arrester, 2-pole, with acoustic signalling, 183  
 Surge arrester, 3-pole, 178, 181, 186, 188  
 Surge arrester, 3-pole + NPE, 176, 179, 185, 202-203  
 Surge arrester, 3-pole + NPE with acoustic signalling, 180  
 Surge arrester, 3-pole + NPE with remote signalling, 177, 180, 185, 202  
 Surge arrester, 3-pole with acoustic signalling, 183  
 Surge arrester, 3-pole with fuse monitoring, 184  
 Surge arrester, 3-pole with NPE, 191  
 Surge arrester, 3-pole with NPE and remote signalling, 191  
 Surge arrester, 3-pole with remote signalling, 182, 187, 189  
 Surge arrester, 4-pole, 181, 186, 188  
 Surge arrester, 4-pole with acoustic signalling, 183  
 Surge arrester, 4-pole with fuse monitoring, 184  
 Surge arrester, 4-pole with remote signalling, 182, 189  
 Surge protection for high-speed networks up to 10, 250 GBit (Class EA/CAT6A)

## T

T connector, 382  
 T connector Rd 8 mm, 359  
 T connector Rd 8–10 mm, 359-360  
 T connector Rd 8-10 mm, triple-screwed, 360  
 Tapered pipe interception rod, 332  
 Terminal for FangFix system, 334  
 Testing unit for lightning barriers, 292  
 TrayFix mounting adapter for mesh cable trays on, 334, 377  
 FangFix system

## U

Underfloor test box, 376  
 Underfloor test box with integrated separation point, 376  
 Universal adapter for roof cable holder, type, 345 165/MBG  
 Universal bi-metal separating piece, 373  
 Universal cable bracket Rd 8–10 mm, 348  
 Universal cable bracket Rd 8–10 mm with pre-, 348 mounted wood screw  
 Universal cable bracket Rd 8–10 mm, copper-plated, 348  
 Universal clamping block Rd 8–10 mm, 368  
 Universal downspout clip 60–130 mm, 369-370  
 Universal separating piece, 372-373  
 Upper part total spark gap between N and PE 255 V, 164, 195  
 Upper part, combination arrester with function display, 142  
 Upper part, lightning current arrester, 142  
 Upper part, lightning current arrester with function, 142 display  
 Upper part, surge arrester 150 V, 193, 204  
 Upper part, surge arrester 280 V, 193, 204  
 Upper part, surge arrester 320 V, 193, 204  
 Upper part, surge arrester 335 V, 194  
 Upper part, surge arrester 385 V, 194, 204  
 Upper part, surge arrester 440 V, 194  
 Upper part, surge arrester 550 V, 194  
 Upper part, surge arrester 75 V, 193  
 Upper part, surge protection, leak current-free, 195

## V

VA cable bracket, 389  
 VA cable bracket with tightening strap, 389  
 VA roof cable holder, sloping roof, 390  
 Variable bi-metal quick connector, 355  
 Variable earthing connector Rd 6-8 / 8-10 mm, 355-356  
 Variable earthing terminal, 322  
 Vario quick connector, 355  
 Vario quick connector Rd 8-10x16, 356  
 VG housing with MC 50-B/3, 139  
 VG housing with MC 50-B/3+1, 138

## V

VG housing with MCD 50-B/3, 139  
 VG housing with MCD 50-B/3+1, 138

## W

Wall connection, 383  
 Wall connection, angled, 385  
 Washer for cable bracket, type 177, 347  
 Water repellent, 386  
 Wedge connector, 323  
 Wire straightening machine, 378

## Z

Zinc repairs, 377

# Numeric directory

Structure of the GTIN: Country code **40**    Manufacturer code **1219**    Individual GTIN **5647589**

GTIN	Art. no.	Price	Page	GTIN	Art. no.	Price	Page	GTIN	Art. no.	Price	Page	GTIN	Art. no.	Price	Page
504651	<b>1117 02 5</b>	/100 m	306	525039	<b>3133 02 8</b>	/100 pc.	378	569934	<b>5015 83 6</b>	/pc.	301	538551	<b>5040 13 2</b>	/100 pc.	304
504657	<b>1117 03 3</b>		306	525045	<b>3133 03 6</b>		378	500226	<b>5015 84 2</b>		301	538557	<b>5040 15 9</b>		304
				525057	<b>3133 23 0</b>		378	569935	<b>5015 84 4</b>		301	538593	<b>5040 50 7</b>		304
543237	<b>1167 00 6</b>	/100 pc.	306			/pc.		569936	<b>5015 84 7</b>		301				
543243	<b>1167 01 4</b>		306	537129	<b>5000 01 7</b>		313	569940	<b>5015 84 9</b>		301	538599	<b>5043 01 8</b>		306
543249	<b>1167 02 2</b>		306	537135	<b>5000 02 5</b>		313	500227	<b>5015 85 4</b>		301	538605	<b>5043 10 7</b>		306
543255	<b>1167 03 0</b>		306	537147	<b>5000 20 3</b>		313	500228	<b>5015 86 6</b>		301				
543261	<b>1167 04 9</b>		306	537147	<b>5000 20 3</b>		313	503361	<b>5015 88 0</b>		301	538611	<b>5050 03 0</b>		304
				501800	<b>5000 29 7</b>		312	503367	<b>5015 88 4</b>		301	538617	<b>5050 05 7</b>		304
				561735	<b>5000 30 0</b>		312	503373	<b>5015 89 0</b>		301	538623	<b>5050 07 3</b>		304
511671	<b>1362 01 1</b>		352	570883	<b>5000 33 5</b>		312				301	538629	<b>5050 08 1</b>		304
511683	<b>1362 04 6</b>		354	537171	<b>5000 50 5</b>		313	537909	<b>5016 02 9</b>		302	538635	<b>5050 11 1</b>		304
				501804	<b>5000 74 2</b>		312	537915	<b>5016 03 7</b>		302	538641	<b>5050 13 8</b>		304
565536	<b>2146 16 4</b>		389	581445	<b>5000 75 0</b>		312	537921	<b>5016 04 5</b>		302	538647	<b>5050 15 4</b>		304
559571	<b>2146 20 7</b>		389	511104	<b>5000 76 9</b>		312	592221	<b>5016 09 6</b>		302	538653	<b>5050 17 0</b>		304
501606	<b>2146 50 9</b>		389	574065	<b>5000 85 8</b>		312	580035	<b>5016 11 8</b>		302	538659	<b>5050 19 7</b>		304
				537183	<b>5000 86 6</b>		312	592227	<b>5016 12 6</b>		302				
				537189	<b>5000 94 7</b>		312	537927	<b>5016 14 2</b>		323	538665	<b>5051 50 9</b>		305
574167	<b>2153 73 4</b>		390	537195	<b>5000 95 5</b>		312								
550539	<b>2153 78 7</b>		390							/100 m					305
				537237	<b>5001 21 8</b>		318	580041	<b>5018 50 1</b>		310	538683	<b>5052 07 6</b>		305
				537243	<b>5001 22 6</b>		318	580047	<b>5018 70 6</b>		310	538689	<b>5052 09 2</b>		305
589692	<b>2332 78 4</b>		393	563547	<b>5001 36 6</b>		318	502201	<b>5018 73 0</b>		310	538695	<b>5052 11 4</b>		305
				537255	<b>5001 40 4</b>		318					538701	<b>5052 13 0</b>		305
522885	<b>2349 04 3</b>		378	537261	<b>5001 41 2</b>		318	568046	<b>5019 34 0</b>		310	538707	<b>5052 15 7</b>		305
522891	<b>2349 05 1</b>		378	537285	<b>5001 56 0</b>		318	569400	<b>5019 34 2</b>		310	538719	<b>5052 18 1</b>		305
522897	<b>2349 07 8</b>		378	563523	<b>5001 61 7</b>		318	569401	<b>5019 34 4</b>		310	538851	<b>5057 50 7</b>		303
522903	<b>2349 08 6</b>		378	575265	<b>5001 62 5</b>		318	568047	<b>5019 34 5</b>		310	538857	<b>5057 51 5</b>		303
522915	<b>2349 10 8</b>		378	586269	<b>5001 63 3</b>		318	568048	<b>5019 34 7</b>		310	538863	<b>5057 52 3</b>		303
522921	<b>2349 12 4</b>		378	537291	<b>5001 64 1</b>		318	568049	<b>5019 35 0</b>		310	538869	<b>5057 55 8</b>		303
				537297	<b>5001 66 8</b>		318	568050	<b>5019 35 5</b>		310	569965	<b>5057 59 9</b>		392
501618	<b>2351 70 6</b>		389	590125	<b>5001 67 2</b>		318	568051	<b>5019 36 0</b>		310				
		/pc.		575487	<b>5001 74 9</b>		318	538155	<b>5021 08 1</b>		310	580545	<b>5057 92 2</b>	/100 m	303
523053	<b>2360 05 5</b>		326					538161	<b>5021 10 3</b>		310	580551	<b>5057 93 0</b>	/100 pc.	303
523059	<b>2360 10 1</b>		326	537357	<b>5003 00 8</b>		316	538173	<b>5021 16 2</b>		310				
				537363	<b>5003 01 6</b>		316	580137	<b>5021 22 7</b>		311	538887	<b>5059 35 6</b>		326
				537369	<b>5003 02 4</b>		316	568052	<b>5021 23 5</b>		311	538905	<b>5059 49 6</b>		326
551841	<b>2362 97 0</b>		377	537375	<b>5003 03 2</b>		316	568056	<b>5021 23 9</b>		311				
				537381	<b>5003 04 0</b>		316	538191	<b>5021 28 6</b>		311	538923	<b>5064 01 5</b>		306
				537399	<b>5003 25 3</b>		316	590127	<b>5021 29 4</b>		311				
524271	<b>3041 20 4</b>		313	537405	<b>5003 26 1</b>		316	538197	<b>5021 30 8</b>		311				
524277	<b>3041 21 2</b>		313	537411	<b>5003 28 8</b>		316	506747	<b>5021 33 2</b>		311				
524283	<b>3041 25 5</b>		313	537417	<b>5003 29 6</b>		316	538203	<b>5021 48 0</b>		311	591597	<b>5080 05 3</b>	/pc.	255
561723	<b>3041 40 9</b>		313	537423	<b>5003 31 8</b>		316	538209	<b>5021 50 2</b>		311	591627	<b>5080 06 1</b>		256
524295	<b>3041 95 6</b>		313	537471	<b>5003 77 6</b>		317	590205	<b>5021 64 2</b>		311	591603	<b>5080 15 0</b>		255
				537477	<b>5003 78 4</b>		317	568057	<b>5021 64 4</b>		311	591621	<b>5080 27 4</b>		255
524313	<b>3042 20 0</b>		314					568058	<b>5021 64 7</b>		311	591639	<b>5080 28 2</b>		256
524319	<b>3042 25 1</b>		314	537687	<b>5009 21 9</b>		317	538221	<b>5021 65 0</b>						
561729	<b>3042 30 8</b>		313	537693	<b>5009 22 7</b>		317	583620	<b>5021 65 4</b>			588945	<b>5081 54 8</b>		239
				537699	<b>5009 23 5</b>		317	538233	<b>5021 80 4</b>		310	550263	<b>5081 64 5</b>		253
524331	<b>3043 20 7</b>		314			/100 pc.				/100 pc.		550269	<b>5081 64 7</b>		253
524337	<b>3043 25 8</b>		314	537771	<b>5012 01 5</b>		322	538269	<b>5025 20 6</b>		325	583479	<b>5081 68 8</b>		237
571749	<b>3043 31 2</b>		314			/pc.		538305	<b>5028 03 5</b>		325	523995	<b>5081 72 6</b>		252
524355	<b>3043 40 1</b>		314					538311	<b>5028 04 3</b>		325	523989	<b>5081 73 4</b>		252
524361	<b>3043 45 2</b>		314	537789	<b>5014 01 8</b>		323				325	546243	<b>5081 79 3</b>		250
511116	<b>3043 60 2</b>		315	537795	<b>5014 02 6</b>		323					561436	<b>5081 80 0</b>		250
561741	<b>3043 60 6</b>		315	537801	<b>5014 21 2</b>		323	538341	<b>5030 02 1</b>		325	568053	<b>5081 92 0</b>		237
508707	<b>3043 61 0</b>		315	590193	<b>5014 42 5</b>		322	538365	<b>5030 23 4</b>			568041	<b>5081 93 9</b>		238
508713	<b>3043 61 4</b>		315	510501	<b>5014 46 8</b>		322	538371	<b>5030 24 2</b>			579111	<b>5081 96 3</b>		238
511164	<b>3043 61 8</b>		315	510507	<b>5014 47 6</b>		322					579105	<b>5081 97 1</b>		238
542162	<b>3043 62 8</b>		315					538383	<b>5032 03 2</b>		324				
524379	<b>3043 70 3</b>		314	537807	<b>5015 01 4</b>		299	538389	<b>5032 04 0</b>		324	568533	<b>5082 38 2</b>		251
524385	<b>3043 75 4</b>		314	537813	<b>5015 05 7</b>		298	538395	<b>5032 23 7</b>		324	568491	<b>5082 41 2</b>		250
564231	<b>3043 90 8</b>		314	537819	<b>5015 06 5</b>			538401	<b>5032 24 5</b>		324	568485	<b>5082 42 0</b>		250
545379	<b>3043 91 6</b>		315	537825	<b>5015 07 3</b>		297	538413	<b>5032 53 9</b>		324	568507	<b>5082 42 2</b>		251
				537831	<b>5015 08 1</b>		298	538419	<b>5032 54 7</b>		324				
564297	<b>3044 83 1</b>		315	595942	<b>5015 11 1</b>		300					591759	<b>5083 06 0</b>		257
564303	<b>3044 90 4</b>		315	580011	<b>5015 20 0</b>		298	538443	<b>5033 03 9</b>		324	591771	<b>5083 08 7</b>		257
545397	<b>3044 91 2</b>		315	537837	<b>5015 50 2</b>		298	543375	<b>5033 20 9</b>		324	502297	<b>5083 40 0</b>		248
				537843	<b>5015 54 5</b>										
				537849	<b>5015 55 3</b>		299	538455	<b>5038 01 4</b>		304	552513	<b>5084 00 8</b>		241
		/100 pc.		547783	<b>5015 55 7</b>			538461	<b>5038 03 0</b>		304	552519	<b>5084 01 2</b>		241
563169	<b>3049 20 5</b>		326	537855	<b>5015 65 0</b>		296	538467	<b>5038 05 7</b>		304	552525	<b>5084 01 6</b>		241
563163	<b>3049 22 1</b>		326	537861	<b>5015 70 7</b>		297	538473	<b>5038 07 3</b>		304	552531	<b>5084 02 0</b>		241
563157	<b>3049 25 6</b>		326	537867	<b>5015 71 5</b>		297	538479	<b>5038 08 1</b>		304	552537	<b>5084 02 4</b>		242
563151	<b>3049 30 2</b>		326	537873	<b>5015 72 3</b>		297	538485	<b>5038 11 1</b>		304	552543	<b>5084 02 8</b>		242
563145	<b>3049 32 9</b>		326	537879	<b>5015 73 1</b>		296	538491	<b>5038 13 8</b>		304	552549	<b>5084 03 2</b>		242
563139	<b>3049 34 5</b>		326	537885	<b>5015 75 8</b>		296	538497	<b>5038 15 4</b>		304	552555	<b>5084 03 6</b>		242
				537891	<b>5015 76 6</b>		296					552561	<b>5084 04 0</b>		243
				545583											

# Numeric directory

GTIN	Art. no.	Price	Page	GTIN	Art. no.	Price	Page	GTIN	Art. no.	Price	Page	GTIN	Art. no.	Price	Page
		/pc.				/pc.				/pc.				/pc.	
589080	<b>5088 60 5</b>		230	547855	<b>5093 62 8</b>		220	536393	<b>5094 92 4</b>		203	557813	<b>5097 61 5</b>		214
589081	<b>5088 60 9</b>		230	570906	<b>5093 62 9</b>		220	536394	<b>5094 93 1</b>		202	557814	<b>5097 62 3</b>		214
587264	<b>5088 62 5</b>		224	536190	<b>5093 63 1</b>		150					557815	<b>5097 63 1</b>		215
587265	<b>5088 62 9</b>		224	536191	<b>5093 64 3</b>		150	591939	<b>5095 60 3</b>		164	557816	<b>5097 65 0</b>		215
582946	<b>5088 64 6</b>		224	536192	<b>5093 64 7</b>		150	554295	<b>5095 60 6</b>		156	557818	<b>5097 82 0</b>		216
582947	<b>5088 64 8</b>		224	568842	<b>5093 65 3</b>		148					581225	<b>5097 82 2</b>		261
578070	<b>5088 65 0</b>		226	542512	<b>5093 65 4</b>		148	539319	<b>5096 25 1</b>		184	581226	<b>5097 82 4</b>		262
578071	<b>5088 65 1</b>		225	583679	<b>5093 65 5</b>		148	539325	<b>5096 27 8</b>		184	557819	<b>5097 84 6</b>		216
578072	<b>5088 65 2</b>		225	568843	<b>5093 66 1</b>		149	539355	<b>5096 35 9</b>		165	557821	<b>5097 85 8</b>		216
570895	<b>5088 67 0</b>		229	542513	<b>5093 66 2</b>		149	539361	<b>5096 36 7</b>		165	557824	<b>5097 93 1</b>		217
570896	<b>5088 67 2</b>		229	536195	<b>5093 72 4</b>		151	506340	<b>5096 37 0</b>		166	557825	<b>5097 93 5</b>		217
570900	<b>5088 67 6</b>		229	570884	<b>5093 72 6</b>		231	524710	<b>5096 37 2</b>		166	557826	<b>5097 93 9</b>		217
570901	<b>5088 67 8</b>		229	596224	<b>5093 98 8</b>		246	539367	<b>5096 37 5</b>		183	557827	<b>5097 97 6</b>		265
561370	<b>5088 69 1</b>		226	580599	<b>5093 99 6</b>		246	539373	<b>5096 38 3</b>		183				
561371	<b>5088 69 2</b>		226					539379	<b>5096 39 1</b>		183	568333	<b>5098 38 0</b>		282
561372	<b>5088 69 3</b>		226	568193	<b>5094 40 0</b>		151	561747	<b>5096 39 7</b>		180	568334	<b>5098 38 2</b>		282
537109	<b>5088 69 4</b>		230	545747	<b>5094 40 1</b>		155	539385	<b>5096 41 3</b>		166	568338	<b>5098 39 0</b>		282
583564	<b>5088 69 5</b>		227	538281	<b>5094 40 3</b>		155	539391	<b>5096 42 1</b>		166	568339	<b>5098 39 2</b>		282
583565	<b>5088 69 6</b>		227	540655	<b>5094 41 8</b>		158	539397	<b>5096 44 8</b>		166	540683	<b>5098 40 4</b>		274
547320	<b>5088 69 9</b>		230	538282	<b>5094 42 1</b>		158	546445	<b>5096 63 7</b>		232	540684	<b>5098 40 7</b>		274
570401	<b>5088 70 3</b>		228	523973	<b>5094 42 3</b>		158	546446	<b>5096 63 9</b>		232	540685	<b>5098 41 1</b>		274
504715	<b>5088 87 9</b>		164	523974	<b>5094 42 6</b>		158	564849	<b>5096 64 6</b>		232	584851	<b>5098 41 2</b>		284
				540656	<b>5094 43 1</b>		162	529945	<b>5096 64 7</b>		232	562512	<b>5098 41 3</b>		277
553101	<b>5089 20 0</b>		138	538283	<b>5094 43 4</b>		162	541573	<b>5096 64 8</b>		165	578737	<b>5098 41 5</b>		278
553107	<b>5089 21 2</b>		139	523975	<b>5094 43 7</b>		162	541574	<b>5096 64 9</b>		165	577361	<b>5098 41 9</b>		278
523734	<b>5089 65 0</b>		201	523976	<b>5094 44 0</b>		162	541577	<b>5096 65 0</b>		165	540686	<b>5098 42 2</b>		275
529940	<b>5089 65 2</b>		201	537488	<b>5094 44 4</b>		157	541578	<b>5096 65 1</b>		165	578738	<b>5098 42 5</b>		279
523735	<b>5089 65 5</b>		164	538284	<b>5094 44 8</b>		154	541579	<b>5096 65 3</b>		165	540687	<b>5098 42 7</b>		275
570935	<b>5089 66 0</b>		206	523981	<b>5094 45 4</b>		154	541580	<b>5096 65 4</b>		165	540688	<b>5098 43 1</b>		275
570936	<b>5089 66 2</b>		206	538285	<b>5094 45 7</b>		156	506748	<b>5096 65 5</b>		165	584852	<b>5098 43 2</b>		284
575978	<b>5089 74 8</b>		167	523982	<b>5094 46 0</b>		156	506749	<b>5096 65 7</b>		165	562513	<b>5098 43 3</b>		279
540552	<b>5089 75 4</b>		168	523986	<b>5094 46 3</b>		156	506750	<b>5096 66 5</b>		165	540689	<b>5098 44 2</b>		276
580681	<b>5089 75 5</b>		168	523988	<b>5094 47 8</b>		161	506753	<b>5096 66 7</b>		165	540690	<b>5098 44 6</b>		276
540553	<b>5089 75 6</b>		168	523992	<b>5094 49 0</b>		159	506754	<b>5096 66 9</b>		165	540691	<b>5098 45 0</b>		276
581661	<b>5089 75 7</b>		168	523993	<b>5094 49 3</b>		159	506755	<b>5096 67 1</b>		165	584853	<b>5098 45 2</b>		284
540554	<b>5089 76 1</b>		167	523994	<b>5094 51 0</b>		157	587120	<b>5096 67 2</b>		191	541046	<b>5098 47 0</b>		280
540555	<b>5089 76 3</b>		167	523999	<b>5094 52 6</b>		161	587124	<b>5096 67 3</b>		191	581352	<b>5098 47 5</b>		280
540556	<b>5089 76 8</b>		170	524001	<b>5094 55 2</b>		160	542514	<b>5096 67 5</b>		152	557828	<b>5098 49 2</b>		266
540557	<b>5089 77 0</b>		169	570907	<b>5094 57 2</b>		222	542515	<b>5096 67 7</b>		152	557829	<b>5098 50 6</b>		266
540558	<b>5089 77 5</b>		170	564848	<b>5094 57 4</b>		223	506756	<b>5096 68 0</b>		165	557830	<b>5098 51 4</b>		266
540559	<b>5089 77 7</b>		169	570908	<b>5094 57 6</b>		222	506759	<b>5096 68 2</b>		165	557831	<b>5098 52 2</b>		266
		/VPE		570887	<b>5094 60 5</b>		222	581348	<b>5096 69 3</b>		164	557833	<b>5098 55 7</b>		267
				547862	<b>5094 60 8</b>		223	561637	<b>5096 69 5</b>		164	557834	<b>5098 57 1</b>		265
546111	<b>5091 32 2</b>		293	570888	<b>5094 61 3</b>		222	551913	<b>5096 70 7</b>		193	557835	<b>5098 57 5</b>		265
546129	<b>5091 43 8</b>		293	570911	<b>5094 61 5</b>		223	542518	<b>5096 78 6</b>		292	557836	<b>5098 60 0</b>		269
546147	<b>5091 52 7</b>		293	547866	<b>5094 61 7</b>		223	592173	<b>5096 81 2</b>		292	557837	<b>5098 60 3</b>		269
		/pc.		540659	<b>5094 61 8</b>		181	548073	<b>5096 82 0</b>		142	557838	<b>5098 61 1</b>		269
546165	<b>5091 68 3</b>		293	538286	<b>5094 62 1</b>		181	554451	<b>5096 82 2</b>		142	557839	<b>5098 63 0</b>		269
589611	<b>5091 69 1</b>		293	524002	<b>5094 62 4</b>		181	505142	<b>5096 82 5</b>		142	557840	<b>5098 63 8</b>		270
				524003	<b>5094 62 7</b>		181	505147	<b>5096 82 7</b>		142	557841	<b>5098 64 6</b>		270
508088	<b>5092 45 1</b>		212	537492	<b>5094 63 2</b>		182	528828	<b>5096 83 5</b>		137	557842	<b>5098 72 7</b>		268
524709	<b>5092 46 0</b>		212	537498	<b>5094 63 6</b>		189	528829	<b>5096 83 6</b>		136	557843	<b>5098 79 4</b>		268
547580	<b>5092 46 6</b>		212	538296	<b>5094 63 9</b>		176	548079	<b>5096 83 9</b>		143	557844	<b>5098 80 8</b>		271
561358	<b>5092 47 0</b>		212	524004	<b>5094 64 1</b>		176	596638	<b>5096 84 7</b>		141	557845	<b>5098 81 6</b>		271
561359	<b>5092 47 2</b>		212	524005	<b>5094 64 4</b>		176	554115	<b>5096 84 9</b>		137	557846	<b>5098 82 4</b>		271
531483	<b>5092 60 4</b>		211	538297	<b>5094 65 0</b>		179	505141	<b>5096 85 1</b>		141	557851	<b>5098 85 9</b>		272
595281	<b>5092 70 1</b>		211	524006	<b>5094 65 3</b>		179	505146	<b>5096 85 2</b>		137	557852	<b>5098 86 7</b>		271
503505	<b>5092 80 0</b>		210	524009	<b>5094 65 6</b>		179	596644	<b>5096 86 3</b>		140				
503511	<b>5092 80 8</b>		210	538298	<b>5094 66 6</b>		185	554139	<b>5096 86 5</b>		136	540671	<b>5099 47 5</b>		192
504722	<b>5092 81 2</b>		211	524011	<b>5094 66 8</b>		185	536202	<b>5096 87 4</b>		139	539673	<b>5099 57 9</b>		193
503517	<b>5092 81 6</b>		210	540661	<b>5094 67 7</b>		178	536203	<b>5096 87 5</b>		138	539685	<b>5099 59 5</b>		194
503523	<b>5092 82 4</b>		210	538288	<b>5094 67 9</b>		178	507704	<b>5096 87 6</b>		141	539691	<b>5099 60 9</b>		193
504725	<b>5092 82 8</b>		211	524012	<b>5094 68 0</b>		178	507707	<b>5096 87 7</b>		137	570890	<b>5099 61 1</b>		231
				540665	<b>5094 70 3</b>		186	507708	<b>5096 87 8</b>		140	580761	<b>5099 61 3</b>		195
539067	<b>5093 01 5</b>		245	538289	<b>5094 70 4</b>		186	507709	<b>5096 87 9</b>		136	539697	<b>5099 61 7</b>		194
539073	<b>5093 02 3</b>		245	524015	<b>5094 70 5</b>		186	553113	<b>5096 88 4</b>		143	594249	<b>5099 70 6</b>		194

# Numeric directory

Structure of the GTIN: Country code **40** Manufacturer code **1219** Individual GTIN **5647589**

GTIN	Art. no.	Price	Page	GTIN	Art. no.	Price	Page	GTIN	Art. no.	Price	Page	GTIN	Art. no.	Price	Page
540039	<b>5102 27 8</b>	/100 pc.	371	540879	<b>5218 68 3</b>	/100 pc.	345	541647	<b>5304 60 1</b>	/100 pc.	358	543368	<b>5316 45 0</b>	/100 pc.	365
				540885	<b>5218 69 1</b>		345	581775	<b>5304 66 0</b>		358	543372	<b>5316 45 9</b>		365
		/pc.		590451	<b>5218 74 8</b>		345	541695	<b>5304 97 0</b>		358	543373	<b>5316 46 8</b>		365
540087	<b>5106 00 1</b>		376	581463	<b>5218 75 6</b>		345	541707	<b>5304 99 7</b>		322	542031	<b>5316 51 0</b>		367
540093	<b>5106 02 8</b>		376	540891	<b>5218 81 0</b>		346					542037	<b>5316 55 3</b>		367
590037	<b>5106 13 3</b>		376	540897	<b>5218 82 9</b>		346								
590043	<b>5106 14 1</b>		376	540903	<b>5218 86 1</b>		345	541731	<b>5311 03 9</b>		359	542043	<b>5317 01 0</b>		363
								541737	<b>5311 10 1</b>		359	542049	<b>5317 05 3</b>		363
		/100 pc.		567458	<b>5218 88 2</b>		345	541743	<b>5311 15 2</b>		360	542055	<b>5317 20 7</b>		363
540159	<b>5201 10 1</b>		336					541749	<b>5311 20 9</b>		360	589315	<b>5317 20 8</b>		363
				562305	<b>5218 88 5</b>		345	541755	<b>5311 26 8</b>		360			/100 pc.	
590433	<b>5202 21 3</b>		344	540909	<b>5218 92 6</b>		369	581658	<b>5311 41 0</b>		355	542061	<b>5317 22 3</b>		364
540213	<b>5202 24 8</b>		344	595221	<b>5218 97 7</b>		346	581659	<b>5311 41 7</b>		356	542067	<b>5317 25 8</b>		364
540303	<b>5202 51 5</b>		340	562588	<b>5218 99 7</b>		346	541767	<b>5311 50 0</b>		355	542073	<b>5317 27 4</b>		364
590229	<b>5202 56 6</b>		341					573706	<b>5311 50 3</b>		305	542079	<b>5317 40 1</b>		364
589412	<b>5202 56 8</b>		341	540945	<b>5223 07 5</b>		350	541773	<b>5311 51 9</b>		355	542085	<b>5317 42 8</b>		365
589422	<b>5202 56 9</b>		344	540951	<b>5223 10 5</b>		350	541779	<b>5311 52 7</b>		355	542091	<b>5317 45 2</b>		364
590223	<b>5202 59 0</b>		341	540963	<b>5223 15 6</b>		350	583539	<b>5311 53 0</b>		301	542097	<b>5317 47 9</b>		365
540381	<b>5202 83 3</b>		340	540975	<b>5223 20 2</b>		350	541785	<b>5311 53 5</b>		355	585086	<b>5317 48 1</b>		364
578492	<b>5202 83 6</b>		340	540993	<b>5223 60 1</b>		350	541791	<b>5311 55 1</b>		355				
590217	<b>5202 86 8</b>		340					583534	<b>5311 55 4</b>		301	542103	<b>5318 08 4</b>		363
				541041	<b>5226 57 0</b>		350	569378	<b>5311 57 3</b>		306	542109	<b>5318 14 9</b>		363
503826	<b>5203 01 5</b>		340					546619	<b>5311 58 5</b>		305				
578496	<b>5203 01 8</b>		340	541053	<b>5227 07 0</b>		351	592544	<b>5311 59 0</b>		356	542127	<b>5320 01 1</b>		368
528974	<b>5203 02 3</b>		340	541059	<b>5227 08 9</b>		351					542133	<b>5320 05 4</b>		368
				541065	<b>5227 10 0</b>		351	545199	<b>5311 70 5</b>		355	542151	<b>5320 69 0</b>		369
540465	<b>5207 25 8</b>		348	541071	<b>5227 15 1</b>		351	545205	<b>5311 71 3</b>		355	542157	<b>5320 70 4</b>		369
511039	<b>5207 26 6</b>		348									542163	<b>5320 71 2</b>		369
540477	<b>5207 33 9</b>		347	541083	<b>5228 02 6</b>		351	541797	<b>5312 03 5</b>		361				
573576	<b>5207 34 2</b>		347	541095	<b>5228 12 3</b>		351	541803	<b>5312 13 2</b>		361	542187	<b>5325 30 7</b>		367
540483	<b>5207 34 7</b>		347	541101	<b>5228 13 1</b>		351	541809	<b>5312 31 0</b>		320	542193	<b>5325 31 5</b>		367
506954	<b>5207 37 1</b>		347	585101	<b>5228 13 4</b>		351	570086	<b>5312 31 8</b>		320				
540489	<b>5207 44 4</b>		348	541107	<b>5228 22 0</b>		353	541815	<b>5312 34 5</b>		320	542241	<b>5326 30 3</b>		368
500972	<b>5207 45 1</b>		348	541119	<b>5228 32 8</b>		351					542247	<b>5326 31 1</b>		368
540495	<b>5207 46 0</b>		348					589310	<b>5312 34 6</b>		320	542253	<b>5326 33 8</b>		368
540501	<b>5207 48 7</b>		348	541149	<b>5229 16 2</b>		349								
590499	<b>5207 74 6</b>		348	541155	<b>5229 36 7</b>		350					545361	<b>5328 20 9</b>		359
590505	<b>5207 75 4</b>		348	541161	<b>5229 38 3</b>		350	541821	<b>5312 41 8</b>		320	545367	<b>5328 28 4</b>		359
590511	<b>5207 76 2</b>		348	541167	<b>5229 46 4</b>		350	541827	<b>5312 44 2</b>		320				
590487	<b>5207 80 0</b>		347	541173	<b>5229 48 0</b>		350	541833	<b>5312 60 4</b>		319	542319	<b>5329 07 8</b>		359
590493	<b>5207 81 9</b>		347	541197	<b>5229 55 3</b>		350	541839	<b>5312 65 5</b>		321				
533643	<b>5207 85 1</b>		348	541215	<b>5229 83 9</b>		349					588557	<b>5331 00 8</b>		369
533481	<b>5207 87 8</b>		348	541221	<b>5229 96 0</b>		349	589314	<b>5312 65 6</b>		321	542337	<b>5331 01 3</b>		369
591583	<b>5207 90 1</b>		347	584088	<b>5229 96 1</b>		349					588558	<b>5331 01 7</b>		369
												542343	<b>5331 50 1</b>		369
		/100 pc.		544623	<b>5230 21 7</b>		349	541857	<b>5312 80 9</b>		320				
540525	<b>5208 01 7</b>		351	562953	<b>5230 32 2</b>		349	541869	<b>5312 90 6</b>		321	562911	<b>5334 93 4</b>		323
				562947	<b>5230 36 5</b>		349	541875	<b>5312 92 2</b>		321	595966	<b>5334 94 2</b>		323
590367	<b>5215 27 7</b>		343	573999	<b>5230 44 6</b>		324	570087	<b>5312 92 5</b>		321				
590379	<b>5215 30 7</b>		344	574005	<b>5230 46 2</b>		324					589005	<b>5335 14 0</b>		372
581187	<b>5215 37 4</b>		343	595960	<b>5230 52 7</b>		353	574053	<b>5313 01 5</b>		321	589011	<b>5335 16 7</b>		372
581193	<b>5215 38 2</b>		343					574047	<b>5313 02 3</b>		321	542361	<b>5335 20 5</b>		372
540717	<b>5215 43 9</b>		343					554301	<b>5313 03 1</b>		321	542367	<b>5335 25 6</b>		372
581211	<b>5215 47 1</b>		343					580653	<b>5313 06 6</b>		321				
540723	<b>5215 50 1</b>		342	541257	<b>5240 03 4</b>		288					542421	<b>5336 00 7</b>		372
578497	<b>5215 50 4</b>		342	541263	<b>5240 05 0</b>		289	541899	<b>5314 03 8</b>		361	542427	<b>5336 02 3</b>		373
590259	<b>5215 54 4</b>		341	541269	<b>5240 06 9</b>		288	541911	<b>5314 13 5</b>		361	542433	<b>5336 05 8</b>		372
540729	<b>5215 55 2</b>		341	541275	<b>5240 07 7</b>		288					542439	<b>5336 07 4</b>		373
578498	<b>5215 55 5</b>		341	541281	<b>5240 08 5</b>		288	541917	<b>5314 51 8</b>		319	542445	<b>5336 09 0</b>		373
581223	<b>5215 57 9</b>		341					541923	<b>5314 53 4</b>		319	542463	<b>5336 30 9</b>		373
578501	<b>5215 58 2</b>		341	541299	<b>5240 22 0</b>		288	541929	<b>5314 61 5</b>		319	542475	<b>5336 34 1</b>		373
581229	<b>5215 58 7</b>		341	541305	<b>5240 23 9</b>		288	589309	<b>5314 61 6</b>		319	542481	<b>5336 37 6</b>		373
581235	<b>5215 59 5</b>		341	541311	<b>5240 24 7</b>		288					542487	<b>5336 45 7</b>		373
578502	<b>5215 59 8</b>		341	541317	<b>5240 25 5</b>		288	541935	<b>5314 62 3</b>		319	542493	<b>5336 50 3</b>		374
581241	<b>5215 60 9</b>		341	541323	<b>5240 30 1</b>		288	541947	<b>5314 65 8</b>		319				
540735	<b>5215 62 5</b>		342	541329	<b>5240 32 8</b>		288	589308	<b>5314 65 9</b>		319	542499	<b>5340 01 2</b>		374
581253	<b>5215 66 8</b>		342	541335	<b>5240 33 6</b>		288								
581259	<b>5215 74 9</b>		342	541341	<b>5240 34 4</b>		288	541953	<b>5314 66 6</b>		319	542559	<b>5350 08 5</b>		370
590235	<b>5215 80 3</b>		343					592587	<b>5314 72 0</b>		319	542565	<b>5350 09 3</b>		370
590241	<b>5215 83 8</b>		343									542571	<b>5350 10 7</b>		370
590247	<b>5215 85 4</b>		343									542577	<b>5350 11 5</b>		370
553179	<b>5215 87 5</b>		342	541569	<b>5304 00 8</b>		356	541971	<b>5315 50 6</b>		358	542583	<b>5350 12 3</b>		3

GTIN	Art. no.	Price	Page	GTIN	Art. no.	Price	Page	GTIN	Art. no.	Price	Page
589071	<b>5351 37 5</b>	/100 pc.	370	581378	<b>5408 06 0</b>	/100 pc.		575229	<b>5412 81 1</b>	/100 pc.	353
542721	<b>5351 45 6</b>		371			/pc.	389	542967	<b>5416 56 6</b>		374
542727	<b>5351 47 2</b>		371	587269	<b>5408 06 4</b>		389				
				587270	<b>5408 06 6</b>		389			/pc.	
542757	<b>5400 15 5</b>		315	587274	<b>5408 06 8</b>		389				
562905	<b>5400 62 7</b>		315	587275	<b>5408 07 2</b>		390	590049	<b>5420 00 8</b>		322
				587276	<b>5408 07 4</b>		390	562929	<b>5420 01 6</b>		322
590133	<b>5401 77 1</b>		334			/100 pc.				/100 pc.	
542781	<b>5401 80 1</b>		334	567492	<b>5408 10 1</b>		384	575157	<b>5420 50 4</b>		315
542787	<b>5401 83 6</b>		334			/pc.	382	533157	<b>5420 53 9</b>		315
589839	<b>5401 85 2</b>		334	569073	<b>5408 10 5</b>		382				
590211	<b>5401 87 9</b>		334	561320	<b>5408 10 7</b>		382	543009	<b>5424 10 0</b>		335
503481	<b>5401 97 0</b>		332	561321	<b>5408 10 8</b>		382	543021	<b>5424 15 1</b>		316
510561	<b>5401 98 0</b>		332	561322	<b>5408 10 9</b>		382	543033	<b>5424 20 8</b>		316
510777	<b>5401 98 3</b>		332	563673	<b>5408 14 8</b>		382				
510867	<b>5401 98 6</b>		332	568149	<b>5408 15 6</b>		382			/pc.	
510873	<b>5401 98 9</b>		332	561323	<b>5408 15 8</b>		382	590145	<b>5430 01 1</b>		316
504535	<b>5401 99 3</b>		332	589581	<b>5408 24 5</b>		383	590157	<b>5430 06 2</b>		316
505080	<b>5401 99 5</b>		332	561324	<b>5408 24 7</b>		383			/100 pc.	
				589587	<b>5408 29 6</b>		383	543057	<b>5430 15 1</b>		316
542805	<b>5402 10 7</b>		335	561325	<b>5408 29 8</b>		383				
542817	<b>5402 15 8</b>		335	567447	<b>5408 35 0</b>		383				
542841	<b>5402 80 8</b>		334	561326	<b>5408 35 2</b>		383			/pc.	
542847	<b>5402 85 9</b>		334	567441	<b>5408 39 3</b>		383	611761	<b>6117 46 5</b>		213
		/pc.		561327	<b>5408 39 5</b>		383	500622	<b>6117 46 7</b>		213
567473	<b>5402 86 4</b>		337	567435	<b>5408 45 8</b>		386	611767	<b>6117 47 3</b>		213
567474	<b>5402 86 6</b>		337	567429	<b>5408 50 4</b>		384	500621	<b>6117 47 5</b>		213
567475	<b>5402 86 8</b>		337	561328	<b>5408 50 6</b>		384				
567476	<b>5402 87 0</b>		337	567423	<b>5408 55 5</b>		384				
567479	<b>5402 87 2</b>		337	561329	<b>5408 55 7</b>		384			/100 pc.	
567480	<b>5402 87 4</b>		337	567417	<b>5408 62 8</b>		384	604908	<b>6404 00 6</b>		306
567481	<b>5402 87 6</b>		337	561331	<b>5408 63 0</b>		384	604920	<b>6404 01 4</b>		306
567482	<b>5402 87 8</b>		337	567381	<b>5408 68 7</b>		383				
567485	<b>5402 88 0</b>		337	561330	<b>5408 68 9</b>		383				
		/100 pc.		567375	<b>5408 73 3</b>		386				
542853	<b>5402 89 1</b>		335	554277	<b>5408 80 6</b>		387				
589791	<b>5402 95 6</b>		335	554283	<b>5408 81 4</b>		387				
				577049	<b>5408 82 0</b>		387				
573842	<b>5403 10 0</b>		334	500460	<b>5408 84 9</b>		386				
507005	<b>5403 10 3</b>		333	500973	<b>5408 85 2</b>		386				
507006	<b>5403 11 0</b>		333	585955	<b>5408 93 0</b>		337				
507007	<b>5403 11 7</b>		334	585956	<b>5408 93 2</b>		337				
507008	<b>5403 12 4</b>		334	587161	<b>5408 93 4</b>		338				
554871	<b>5403 20 0</b>		333	587162	<b>5408 93 6</b>		338				
511063	<b>5403 20 5</b>		333	587166	<b>5408 93 8</b>		337				
554877	<b>5403 21 9</b>		334	587167	<b>5408 94 0</b>		337				
554889	<b>5403 22 7</b>		333	567005	<b>5408 94 2</b>		337				
554895	<b>5403 23 5</b>		333	578533	<b>5408 94 3</b>		337				
592632	<b>5403 23 8</b>		338	567006	<b>5408 94 6</b>		337				
		/pc.		578534	<b>5408 94 7</b>		337				
503487	<b>5403 30 8</b>		332	567007	<b>5408 95 0</b>		338				
503493	<b>5403 32 4</b>		332	567008	<b>5408 95 2</b>		338				
561357	<b>5403 33 0</b>		336	567009	<b>5408 95 4</b>		338				
581390	<b>5403 33 3</b>		336	584936	<b>5408 95 5</b>		339				
567073	<b>5403 33 5</b>		335	567010	<b>5408 95 6</b>		339				
		/100 pc.		584939	<b>5408 95 7</b>		339				
542865	<b>5405 06 8</b>		332	567011	<b>5408 95 8</b>		339				
		/pc.		584940	<b>5408 95 9</b>		339				
542871	<b>5405 76 9</b>		336	567012	<b>5408 96 0</b>		339				
		/100 m		567013	<b>5408 96 4</b>		339				
588812	<b>5407 99 5</b>		388	580243	<b>5408 96 6</b>		337				
588815	<b>5407 99 7</b>		388	580244	<b>5408 96 7</b>		337				
				567014	<b>5408 96 8</b>		337				
567457	<b>5408 00 2</b>		388	567493	<b>5408 96 9</b>		337				
567462	<b>5408 00 4</b>		388	567494	<b>5408 97 1</b>		338				
585426	<b>5408 00 6</b>		388	567497	<b>5408 97 2</b>		338				
		/pc.		567498	<b>5408 97 3</b>		338				
567463	<b>5408 00 9</b>		388	561332	<b>5408 97 6</b>		382				
567464	<b>5408 01 1</b>		388	561333	<b>5408 97 8</b>		382				
567468	<b>5408 02 2</b>		388	561334	<b>5408 98 0</b>		382				
586417	<b>5408 02 4</b>		391	561335	<b>5408 98 2</b>		382				
567469	<b>5408 02 6</b>		392	561336	<b>5408 98 4</b>		385				
567470	<b>5408 02 8</b>		392	561337	<b>5408 98 6</b>		385				
				561338	<b>5408 98 8</b>		385				
587156	<b>5408 03 1</b>		391	561341	<b>5408 99 0</b>		385				
567471	<b>5408 03 6</b>		388	561342	<b>5408 99 2</b>		385				
				561343	<b>5408 99 4</b>		385				
567486	<b>5408 04 3</b>		390	561344	<b>5408 99 6</b>		386				
567487	<b>5408 04 7</b>		390			/100 pc.	353				
567488	<b>5408 04 9</b>		390	542889	<b>5410 09 6</b>		353				
567472	<b>5408 05 2</b>		389	542907	<b>5410 30 4</b>		353				
567491	<b>5408 05 4</b>		389								
569966	<b>5408 05 6</b>		389	542961	<b>5412 60 9</b>		352				
581377	<b>5408 05 8</b>		389	544641	<b>5412 63 3</b>		352				
				575235	<b>5412 80 3</b>		353				

# Type listing

Structure of the GTIN: Country code **40**    Manufacturer code **1219**    Individual GTIN **5647589**

Type	Dimensions/Colour/Div.	GTIN	Art. no.	Price	Page	Type	Dimensions/Colour/Div.	GTIN	Art. no.	Price	Page
101 16-1500	1500 / GFK	5613213	5408 10 8	/pc.	382	101 VL2500	2500 / AI	5108672	5401 98 6	/100 pc.	332
101 16-3000	3000 / GFK	5613220	5408 10 9		382	101 VL3000	3000 / AI	5108733	5401 98 9		332
101 16-750	750 / GFK	5613206	5408 10 7		382	101 VL3500	3500 / AI	5045359	5401 99 3		332
101 20-3000	3000 / GFK	5690733	5408 10 5		382	101 VL4000	4000 / AI	5050803	5401 99 5		332
101 20-6000	6000 / GFK	5636731	5408 14 8		382					/pc.	
101 3B-4000	2000 / AI	5674733	5402 86 4		337	101 VRS-16	750	5613350	5408 98 2		382
101 3B-4500	2500 / AI	5674740	5402 86 6		337	101 VS-16	750	5613336	5408 97 8		382
101 3B-5000	3000 / AI	5674757	5402 86 8		337	101 W-16	1660 / AI	5613305	5408 68 9		383
101 3B-5500	3500 / AI	5674764	5402 87 0		337	101 WG-16	16110	5613374	5408 98 6		385
101 3B-6000	4000 / AI	5674795	5402 87 2		337						
101 3B-6500	4500 / AI	5674801	5402 87 4		337						
101 3B-7000	5000 / AI	5674818	5402 87 6		337	108 B DIN	/ St / FT	5429678	5416 56 6	/100 pc.	374
101 3B-7500	5500 / AI	5674825	5402 87 8		337						
101 3B-8000	5500 / AI	5674856	5402 88 0		337	112 DIN-100	100 / St / F	5428893	5410 09 6		353
101 3-ES-16	750	5613329	5408 97 6		382	112 DIN-CU-100	100 / Cu	5429074	5410 30 4		353
				/100 pc.							
101 A-1500	1500 / St / FT	5427575	5400 15 5		315	113 8-10	/ Zn / Cu	5446231	5230 21 7		349
101 A-1500	1500 / St / FT	5427575	5400 15 5		332	113 B-HD-16	/ Zn / Cu	5752295	5412 81 1		353
101 A-1500	1500 / St / FT	5427575	5400 15 5		375	113 B-MS-HD 8-10	/ Zn / Cu	5629474	5230 36 5		349
				/pc.		113 BZ-FL	/ Zn / G	5739999	5230 44 6		324
101 A-16	1660 / AI	5613268	5408 35 2		383	113 B-Z-HD	/ Zn / VZ	5629535	5230 32 2		349
				/100 pc.		113 B-Z-HD	/ Zn / VZ	5752356	5412 80 3		353
101 A-CU	1500 / Cu	5629054	5400 62 7		315	113 B-Z-HD-FL	/ Zn / G	5740056	5230 46 2		324
101 A-CU	1500 / Cu	5629054	5400 62 7		333	113 Z-16	/ Zn / VZ	5429616	5412 60 9		352
101 A-CU	1500 / Cu	5629054	5400 62 7		375	113 Z-20	/ Zn / VZ	5959601	5230 52 7		353
101 A-L100	1000 / St / FT	5428411	5402 80 8		334	113 Z-20	/ Zn / VZ	5959601	5230 52 7		386
101 AL-150	1500 / St / FT	5428473	5402 85 9		334	113 Z-10	/ Zn / G	5412212	5229 96 0		349
101 ALU-1000	1000 / AI	5901334	5401 77 1		334	113 Z-K 8-10	/ Zn / G	5840886	5229 96 1		349
101 ALU-1500	1500 / AI	5427810	5401 80 1		334	113 ZN-16	/ Zn / Cu	5446415	5412 63 3		352
101 ALU-2000	2000 / AI	5427872	5401 83 6		334						
101 ALU-2500	2500 / AI	5898399	5401 85 2		334	120 A	/ Zn / G	5428657	5405 06 8		332
101 ALU-3000	3000 / AI	5902119	5401 87 9		334						
				/pc.						/pc.	
101 A-M16	2060 / AI	5674474	5408 35 0		383	128 F	/ St / FT	5428718	5405 76 9		336
				/100 pc.							
101 B-16 M16	M16	5897910	5402 95 6		335					/100 pc.	
101 B-16 M16	M16	5897910	5402 95 6		383	132 CU	/ Cu	5902171	5202 86 8		340
				/pc.		132 GB-M8	/ St / FT	5894124	5202 56 8		341
101 BB-16	1640	5613381	5408 98 8		385	132 K-CU	/ Cu	5902232	5202 59 0		341
101 BP-16	17540	5613367	5408 98 4		385	132 K-VA	/ V2A	5403036	5202 51 5		340
				/100 pc.		132 N-DK	/ St / FT	5902294	5202 56 6		341
101 F1000	1000 / St / FT	5430094	5424 10 0		335	132 U	/ V2A	5038269	5203 01 5		340
101 F1500	1500 / St / FT	5430216	5424 15 1		316	132 U 35	/ V2A	5784968	5203 01 8		340
101 F1500	1500 / St / FT	5430216	5424 15 1		375	132 U-CU	/ V2A / Cu	5289746	5203 02 3		340
101 F1500	1500 / St / FT	5430216	5424 15 1		335	132 VA	/ V2A	5403814	5202 83 3		340
				/pc.		132 VA 35	/ V2A	5784920	5202 83 6		340
101 F-16	16121	5613428	5408 99 2		385						
				/100 pc.		133 A	/ PA	5402138	5202 24 8		344
101 F2000	2000 / St / FT	5430339	5424 20 8		316	133 NB	/ PA	5904335	5202 21 3		344
101 F2000	2000 / St / FT	5430339	5424 20 8		375						
101 F2000	2000 / St / FT	5430339	5424 20 8		335	156 16	/ St / FT	5411079	5228 22 0		353
				/pc.		156 8-10	/ St / FT	5410836	5228 02 6		351
101 FS-16	750	5613343	5408 98 0		382	156 FL	/ St / FT	5411192	5228 32 8		351
				/100 pc.		156 K8-10 CU	/ Cu	5411017	5228 13 1		351
101 G1000	1000 / St / FT	5428053	5402 10 7		335	156 K8-10 ST	/ St / FT	5410959	5228 12 3		351
101 G1500	1500 / St / FT	5428176	5402 15 8		335	156 K8-10 VA	/ V2A	5851011	5228 13 4		351
				/pc.							
101 HV-16	1690	5613411	5408 99 0		385	157 E-CU	265 / Cu	5902355	5215 80 3		343
101 IAB	18 / AI	5673750	5408 73 3		386	157 EK-CU	265 / Cu	5902478	5215 85 4		343
101 IAG	20107 / AI	5674290	5408 50 4		384	157 EK-VA	265 / V2A	5902416	5215 83 8		343
101 IAG-16	16107 / AI	5613282	5408 50 6		384	157 E-VA	265 / V2A	5407232	5215 50 1		342
101 IDK	20125 / AI	5895817	5408 24 5		383	157 E-VA 35	265 / V2A	5784975	5215 50 4		342
101 IDK-16	16125 / AI	5613244	5408 24 7		383	157 F-CU 230	/ Cu	5902539	5216 19 2		341
101 IES	2060 / AI	5674412	5408 39 3		383	157 F-CU 280	/ Cu	5813019	5216 20 6		341
101 IES-16	1660 / AI	5613275	5408 39 5		383	157 F-CU 410	/ Cu	5813132	5216 25 7		341
101 IGL	20127 / AI	5674177	5408 62 8		384	157 FK-CU 230	/ Cu	5902652	5216 18 4		342
101 IGL-16	16127 / AI	5613312	5408 63 0		384	157 FK-CU 280	/ Cu	5813071	5216 21 4		342
101 IK	20100 / AI	5895879	5408 29 6		383	157 FK-CU 410	/ Cu	5813194	5216 26 5		342
101 IK-16	16100 / AI	5613251	5408 29 8		383	157 FK-VA 230	/ V2A	5902591	5215 54 7		341
101 ISP M10	110 / AI	5674351	5408 45 8		386	157 FK-VA 280	/ V2A	5812296	5215 58 7		341
101 IT	2065 / AI	5681496	5408 15 6		382	157 FK-VA 410	/ V2A	5812418	5215 60 9		341
101 IT-16	1660 / AI	5613237	5408 15 8		382	157 F-VA 230	/ V2A	5407294	5215 55 2		341
101 IV	2060 / AI	5674238	5408 55 5		384	157 F-VA 230 35	/ V2A	5784982	5215 55 5		341
101 IV-16	1660 / AI	5613299	5408 55 7		384	157 F-VA 280	/ V2A	5812234	5215 57 9		341
101 IW-M10	2060 / AI	5673811	5408 68 7		383	157 F-VA 280 35	/ V2A	5785019	5215 58 2		341
				/100 pc.		157 F-VA 410	/ V2A	5812357	5215 59 5		341
101 J1000	1000 / AI	5034810	5401 97 0		332	157 F-VA 410 35	/ V2A	5785026	5215 59 8		341
				/pc.		157 FX-AL	/ AI	5531791	5215 87 5		342
101 MA-16	1691	5613442	5408 99 6		386	157 FX-CU	/ Cu	5531852	5215 87 9		342
101 R-16	1681	5613435	5408 99 4		385	157 GB-M8	260 / V2A	5894223	5202 56 9		344
				/100 pc.		157 I-CU	/ Cu	5812593	5215 74 9		342
101 RH-16	Black / PA	5674924	5408 10 1		384	157 IK-VA	/ V2A	5812531	5215 66 8		342
101 ST	M16	5428534	5402 89 1		335	157 IVA	/ V2A	5407355	5215 62 5		342
101 ST	M16	5428534	5402 89 1		383	157 L-CU	212 / Cu	5812111	5215 47 1		343
101 VL1500	1500 / AI	5105619	5401 98 0		332	157 LK-CU	212 / Cu	5811930	5215 38 2		343
101 VL2000	2000 / AI	5107774	5401 98 3		332	157 LK-VA	212 / V2A	5811879	5215 37 4		343

02\_TBS\_Masterkatalog\_Länder\_2012 / en / 10/04/2012 (LLEXP01433)



Type	Dimensions/Colour/Div.	GTIN	Art. no.	Price	Page	Type	Dimensions/Colour/Div.	GTIN	Art. no.	Price	Page	
157 L-VA	212/ V2A	5407171	5215 43 9	/100 pc.	343	204 KS-2000	2000/ St / F	5901457	5430 01 1	/pc.	375	
157 NB-VA	260/ V2A	5903673	5215 27 7		343	204 KS-2500	2500/ St / F	5901570	5430 06 2		316	
157 ND-VA	260/ V2A	5903796	5215 30 7		344	204 KS-2500	2500/ St / F	5901570	5430 06 2		375	
159 K-VA	/ V2A	5813255	5216 81 8	/100 pc.	344	205 B-M10 VA	M10/ V4A	5900498	5420 00 8	/pc.	322	
159 VA-V	/ V2A	5407959	5217 07 5		344	205 B-M12 VA	M12/ V4A	5629290	5420 01 6		322	
163 100 CU	100/ Cu	5409939	5223 60 1	/100 pc.	350					/pc.		
163 100 FT	100/ St / FT	5409519	5223 10 5		350	213 1000 DIN	1000/ St / FT	5373575	5003 00 8		316	
163 150 FT	150/ St / FT	5409632	5223 15 6		350	213 1000 M	1000/ St / FT	5373995	5003 25 3		316	
163 200 FT	200/ St / FT	5409755	5223 20 2		350	213 1500 DIN	1500/ St / FT	5373636	5003 01 6		316	
163 70 FT	70/ St / FT	5409458	5223 07 5		350	213 1500 F	1500/ St / FT	5374718	5003 77 6		317	
							213 1500 M	1500/ St / FT	5374053		5003 26 1	316
							213 2000 DIN	2000/ St / FT	5373698		5003 02 4	316
165 B 100	/ St / FT	5408970	5218 82 9	346	213 2000 F	2000/ St / FT	5374770	5003 78 4	317			
165 B 60	/ St / FT	5408918	5218 81 0	346	213 2000 M	2000/ St / FT	5374114	5003 28 8	316			
165 KR	/ PE	5409038	5218 86 1	345	213 2500 DIN	2500/ St / FT	5373759	5003 03 2	316			
165 KRB SO		5952213	5218 97 7	346	213 2500 M	2500/ St / FT	5374176	5003 29 6	316			
165 MBG HFL	Black/ PP	5623052	5218 88 5	345	213 3000 DIN	3000/ St / FT	5373810	5003 04 0	316			
165 MBG UH	Black/ PP	5674580	5218 88 2	345	213 3000 M	3000/ St / FT	5374237	5003 31 8	316			
165 MBG UH	Black/ PP	5674580	5218 88 2	390								
165 MBG-10	/ PA/PE	5408734	5218 67 5	/100 pc.	345	219 20 BP CU	1500/ St / Cu	5371717	5000 50 5	/100 pc.	313	
165 MBG-10 200	/ PE	5814634	5218 75 6		345	219 20 BP FT	1500/ St / FT	5371892	5000 94 7		312	
165 MBG-8	/ PA/PE	5408857	5218 69 1		345	219 20 BP V4A	1000/ V4A	5740650	5000 85 8		312	
165 MBG-8 200	/ PE	5904519	5218 74 8		345	219 20 BP V4A	1500/ V4A	5371830	5000 86 6		312	
165 NBK 55	55/ PA	5904274	5218 31 4		345	219 20 OMEX FT	1500/ St / FT	5371298	5000 01 7		313	
165 OBG-8	/ PE	5408796	5218 68 3		346	219 20 OMEX FT	2000/ St / FT	5371472	5000 20 3		313	
165 R-8-10	/ PE	5625889	5218 99 7		345	219 20 ST FT	1000/ St / FT	5018049	5000 74 2		312	
					346	219 20 ST FT	1500/ St / FT	5814450	5000 75 0		312	
							219 25 BP FT	1500/ St / FT	5371953		5000 95 5	312
							219 25 OMEX FT	1500/ St / FT	5371359		5000 02 5	313
166 LS 70	70/ St / FT	5410416	5226 57 0	350	219 25 ST FT	1500/ St / FT	5111047	5000 76 9	312			
168 8-10 M6	M6/ Zn / G	5411499	5229 16 2	349								
168 DIN 30	56/ Zn / G	5411734	5229 48 0	350								
168 DIN-K-M8	M8/ Zn / G	5412151	5229 83 9	349								
168 DIN-K-M8	M8/ Zn / Cu	5411611	5229 38 3	350	223 DIN MS	/ Zn / Cu	5423676	5335 25 6	372			
168 FL30-M6	56/ Zn / VZ	5411673	5229 46 4	350	223 DIN ZN	/ Zn / G	5423614	5335 20 5	372			
168 FL40-M8	66/ TG / FT	5411970	5229 55 3	350	223 O DIN MS	/ Zn / Cu	5890119	5335 16 7	372			
168 ZN-M6	M6/ Zn / Cu	5411550	5229 36 7	350	223 O DIN ZN	/ Zn / G	5890058	5335 14 0	372			
172 AR	/ Al	5409090	5218 92 6	369	226 8-10	/ St / FT	5424215	5336 00 7	372			
176 A 100	100/ TG / F	5410652	5227 10 0	351	226 CU	/ Cu	5424277	5336 02 3	373			
176 A 150	150/ TG / F	5410713	5227 15 1	351	226 VA	/ V2A	5424338	5336 05 8	372			
176 A 65	65/ TG / F	5410539	5227 07 0	351	226 ZV CU	/ V2A	5424451	5336 09 0	373			
176 A 80	80/ TG / F	5410591	5227 08 9	351	226 ZV VA	/ Cu	5424390	5336 07 4	373			
						233 8	/ St / FT	5424635	5336 30 9	373		
177 20 CU	/ PA	5904991	5207 74 6	348	233 A VA	/ V2A	5424871	5336 45 7	373			
177 20 KL	/ PA	5009726	5207 45 1	348	233 A ZV	/ Cu	5424932	5336 50 3	374			
177 20 M8	/ PA	5404897	5207 44 4	348	233 VA	/ V2A	5424758	5336 34 1	373			
177 20 VA B-HD	/ V2A	5915836	5207 90 1	347	233 ZV	/ V2A	5424819	5336 37 6	373			
177 20 VA M6	/ V2A	5404774	5207 33 9	347	237 N CU	/ Cu	5453673	5328 28 4	359			
177 20 VA M8	/ V2A	5404835	5207 34 7	347	237 N FT	/ St / F	5453611	5328 20 9	359			
177 20 VA-VK M6	/ V2A / Cu	5904878	5207 80 0	347								
177 20 VA-VK M8	/ V2A / Cu	5904939	5207 81 9	347	239	/ Zn / G	5423195	5329 07 8	359			
177 30 CU	/ PA	5905059	5207 75 4	348								
177 30 M8	/ PA	5404958	5207 46 0	348	244	/ Zn / G	5417316	5311 03 9	359			
177 35 VA M6	/ V2A	5735762	5207 34 2	347								
177 55 CU	/ PA	5905110	5207 76 2	348	245 8-10 CU	/ Cu	5417439	5311 15 2	360			
177 55 M8	/ PA	5405016	5207 48 7	348	245 8-10 FT	/ St / FT	5417378	5311 10 1	359			
177 B-HD20	/ PA	5336433	5207 85 1	348								
177 B-HD30	/ PA	5334811	5207 87 8	348	247 8-10 CU	/ Cu	5417552	5311 26 8	360			
177 U	Light grey/ PP	5069546	5207 37 1	347	247 8-10 FT	/ St / FT	5417491	5311 20 9	360			
194	Grey M8/ PA	5404651	5207 25 8	348	249 6-10 CU	40/ Cu	5816591	5311 41 7	356			
194 K	Grey M8/ PA	5110392	5207 26 6	348	249 6-10 ST	40/ St / FT	5816584	5311 41 0	355			
198 60	2160	5399674	5101 06 9	377	249 8-10 ALU	44/ Al	5417736	5311 51 9	355			
199 DIN	M8/ St / FS	5405252	5208 01 7	351	249 8-10 ALU-OT	44/ Al	5466192	5311 58 5	305			
200 V4A-1500	1500/ V4A	5751571	5420 50 4	/kg	315	249 8-10 ALU-OT	44/ Al	5466192	5311 58 5	/100 pc.	352	
200 V4A-1500	1500/ V4A	5751571	5420 50 4		377	249 8-10 ALU-OT	44/ Al	5466192	5311 58 5		367	
200 V4A-1500	1500/ V4A	5751571	5420 50 4		375	249 8-10 CU	40/ Cu	5417798	5311 52 7		355	
200 V4A-2000	2000/ V4A	5331575	5420 53 9		315	249 8-10 CU-OT	40/ Cu	5835394	5311 53 0		301	
200 V4A-2000	2000/ V4A	5331575	5420 53 9		333	249 8-10 CU-OT	40/ Cu	5835394	5311 53 0		305	
200 V4A-2000	2000/ V4A	5331575	5420 53 9		375	249 8-10 CU-OT	40/ Cu	5835394	5311 53 0		352	
204 KL-1500	/ St	5430575	5430 15 1		316	249 8-10 CU-OT	40/ Cu	5835394	5311 53 0		367	
204 KL-1500	/ St	5430575	5430 15 1		375	249 8-10 ST	40/ St / FT	5417675	5311 50 0		355	
204 KS-2000	2000/ St / F	5901457	5430 01 1		316	249 8-10 ST-OT	40/ St / FT	5737063	5311 50 3		305	
							249 8-10 ST-OT	40/ St / FT	5737063		5311 50 3	352
							249 8-10 ST-OT	40/ St / FT	5737063		5311 50 3	367
							249 8-10 VA	40/ V2A	5417910		5311 55 1	355
						249 8-10 VA-OT	40/ V2A	5835349	5311 55 4	301		
						249 8-10 VA-OT	40/ V2A	5835349	5311 55 4	305		
						249 8-10 VA-OT	40/ V2A	5835349	5311 55 4	352		
						249 8-10 VA-OT	40/ V2A	5835349	5311 55 4	367		
						249 8-10 ZV	44/ Cu	5417859	5311 53 5	355		

02\_TBS\_Masterkatalog\_Länder\_2012 / en / 10/04/2012 (LLEExport\_01433)

# Type listing

Structure of the GTIN: Country code **40**      Manufacturer code **1219**      Individual GTIN **5647589**

Type	Dimensions/Colour/Div.	GTIN	Art. no.	Price	Page	Type	Dimensions/Colour/Div.	GTIN	Art. no.	Price	Page
249 8-10X16 VA	/ V2A	5925446	5311 59 0	/100 pc.	356	264 CU	/ Cu	5420378	5316 55 3	/100 pc.	367
249 B ALU	44/ Al	5452058	5311 71 3		355	267	/ St / FT	5420132	5316 30 8	365	
249 B ST	40/ FT	5451990	5311 70 5		306	267 VA	/ V2A	5420194	5316 32 4	366	
249 VA-OT	/ V2A	5693789	5311 57 3		353	269 8-10	/ Zn / G	5420439	5317 01 0	363	
249 VA-OT	/ V2A	5693789	5311 57 3		368	269 MS	/ Zn / Cu	5420491	5317 05 3	363	
250	/ St / FT	5418696	5312 90 6		321	270 8-10 CU	/ Cu	5420675	5317 25 8	364	
250	/ St / FT	5418696	5312 90 6		360	270 8-10 FT	/ St / FT	5420552	5317 20 7	363	
250 A-BO	25/ St / F	5806530	5313 06 6		321	270 8-10 VA	/ V2A	5893158	5317 20 8	363	
250 A-FT	40/ St / FT	5740537	5313 01 5		321						
250 AS-FT	20/ St / FT	5543015	5313 03 1		321						
250 A-VA	40/ V2A	5740476	5313 02 3		321	271 8-10	/ St / FT	5420798	5317 40 1	/100 pc.	364
250 V4A	/ V4A	5700876	5312 92 5	360	271 8-10 VA	/ V2A	5850861	5317 48 1	364		
250 V4A	/ V4A	5700876	5312 92 5	321	271 CU	/ Cu	5420910	5317 45 2	364		
250 VA	/ V2A	5418757	5312 92 2	360							
251 8-10	/ St / FT	5417972	5312 03 5	361	272 14	/ TG / FT	5421092	5318 14 9	363		
251 CU	/ Cu	5418030	5312 13 2	361	272 8	/ TG / FT	5421030	5318 08 4	363		
252 8-10 CU	/ Cu	5418214	5312 41 8	320	273 8-10	/ St / FT	5420613	5317 22 3	364		
252 8-10 CU	/ Cu	5418214	5312 41 8	362	273 CU	/ Cu	5420736	5317 27 4	364		
252 8-10 FT	/ St / FT	5418092	5312 31 0	320	274 8-10	/ St / FT	5420859	5317 42 8	365		
252 8-10 FT	/ St / FT	5418092	5312 31 0	361	274 CU	/ Cu	5420972	5317 47 9	365		
252 8-10 V4A	/ V4A	5700869	5312 31 8	320							
252 8-10 V4A	/ V4A	5700869	5312 31 8	362	280 8-10	/ Zn / G	5421276	5320 01 1	368		
252 8-10X16 CU	/ Cu	5418276	5312 44 2	320	280 VK	/ Zn	5421337	5320 05 4	368		
252 8-10X16 CU	/ Cu	5418276	5312 44 2	362							
252 8-10X16 FT	/ St / FT	5418153	5312 34 5	320	287	/ Al	5421573	5320 70 4	369		
252 8-10X16 FT	/ St / FT	5418153	5312 34 5	362	287 CU	/ Cu	5421511	5320 69 0	369		
252 8-10x16 V4A	/ V4A	5893103	5312 34 6	320							
252 8-10x16 V4A	/ V4A	5893103	5312 34 6	362	288 DIN	/ Al	5421634	5320 71 2	369		
252 8-10XFL30 FT	/ St / F	5418399	5312 65 5	321	292 DIN	/ TG / F	5424994	5340 01 2	374		
252 8-10XFL30 FT	/ St / F	5418399	5312 65 5	360	301 CU-100	/ Cu	5426370	5350 70 0	370		
252 8-10xFL30V4A	/ V4A	5893141	5312 65 6	321	301 CU-110	/ Cu	5426431	5350 71 9	370		
252 8-10xFL30V4A	/ V4A	5893141	5312 65 6	360	301 CU-120	/ Cu	5426493	5350 72 7	370		
					301 CU-80	/ Cu	5426257	5350 68 9	370		
					301 CU-90	/ Cu	5426318	5350 69 7	370		
					301 DIN-100	/ St / FS	5425717	5350 10 7	370		
					301 DIN-110	/ St / FS	5425779	5350 11 5	370		
253 10X16	/ St / F	5418573	5312 80 9	320	301 DIN-120	/ St / FS	5425830	5350 12 3	370		
253 10X16	/ St / F	5418573	5312 80 9	362	301 DIN-80	/ St / FS	5425595	5350 08 5	370		
253 8X8	/ St / F	5418337	5312 60 4	319	301 DIN-90	/ St / FS	5425656	5350 09 3	370		
253 8X8	/ St / F	5418337	5312 60 4	361	301 S-100	/ St / FS	5426974	5351 05 7	370		
254 DIN 8-10 CU	/ Cu	5419112	5314 13 5	361	301 S-120	/ St / FS	5427032	5351 07 3	370		
254 DIN 8-10 FT	/ St / FT	5418993	5314 03 8	361	301 S-AL-100	/ Al	5890652	5351 35 9	370		
					301 S-AL-120	/ Al	5890713	5351 37 5	370		
					301 S-CU-100	/ Cu	5427216	5351 45 6	371		
					301 S-CU-120	/ Cu	5427278	5351 47 2	371		
255 30	52/ St / FT	5419174	5314 51 8	319	301 S-VA-100	/ V2A	5427094	5351 25 1	371		
255 A-FL30 FT	60/ St / FT	5419235	5314 53 4	319	301 S-VA-120	/ V2A	5427155	5351 28 6	371		
					301 V	/ St / FS	5426790	5350 86 7	369		
256 A-DIN 30 FT	60/ St / FT	5419471	5314 65 8	319	301 V-CU	/ Cu	5426851	5350 88 3	370		
256 A-DIN 30 V4A	60/ V4A	5893080	5314 65 9	319	301 V-VA	/ V2A	5426912	5350 90 5	370		
256 A-DIN 30 VA	60/ V2A	5925873	5314 72 0	319	303 DIN-1	/ St / FT	5399971	5102 11 1	371		
256 A-DIN 40 FT	80/ St / FT	5419532	5314 66 6	319	303 DIN-1 1/2	/ St / FT	5400097	5102 15 4	371		
256 DIN 30 FT	60/ St / FT	5419297	5314 61 5	319	303 DIN-1 1/4	/ St / FT	5400035	5102 13 8	371		
256 DIN 30 V4A	60/ V4A	5893097	5314 61 6	319	303 DIN-1/2	/ St / FT	5399858	5102 07 3	371		
					303 DIN-2	/ St / FT	5400158	5102 19 7	371		
256 DIN 40 FT	80/ St / FT	5419358	5314 62 3	319	303 DIN-2 1/2	/ St / FT	5400219	5102 21 9	371		
					303 DIN-3	/ St / FT	5400271	5102 23 5	371		
					303 DIN-3 1/2	/ St / FT	5400332	5102 25 1	371		
259 8-10	/ TG / FT	5419716	5315 50 6	358	303 DIN-3/4	/ St / FT	5399919	5102 08 1	371		
259 A FT	/ St / FT	5740414	5315 51 4	322	303 DIN-3/8	/ St / FT	5399797	5102 05 7	371		
259 A FT 8-OT	/ St / FT	5737070	5315 51 7	368	303 DIN-4	/ St / FT	5400394	5102 27 8	371		
259 A ST	/ St	5237198	5315 55 7	322							
259 A VA	/ V2A	5740353	5315 52 2	322	311 N-ALU 16	/ Al	5631392	3049 34 5	326		
					311 N-ALU 16	/ Al	5631392	3049 34 5	374		
260 8	/ Zn / G	5419839	5315 70 0	359	311 N-ALU 8-10		5631576	3049 25 6	326		
260 8-10 MS	/ CuZn / Cu	5419778	5315 65 4	359	311 N-ALU 8-10		5631576	3049 25 6	374		
					311 N-CU 16	/ Cu	5631514	3049 30 2	326		
262	/ St / FT	5419891	5316 01 4	366	311 N-CU 16	/ Cu	5631514	3049 30 2	374		
					311 N-CU 8-10	/ Cu	5631699	3049 20 5	326		
262 A-DIN CU	/ Cu	5420071	5316 25 1	366	311 N-CU 8-10	/ Cu	5631699	3049 20 5	374		
262 A-DIN FT	/ St / FT	5420019	5316 21 9	366	311 N-VA 16	/ V2A	5631453	3049 32 9	326		
262 CU	/ Cu	5419952	5316 15 4	366	311 N-VA 16	/ V2A	5631453	3049 32 9	374		
262 ZM	/ St / FT	5818359	5316 17 0	366	311 N-VA 8-10	/ V2A	5631637	3049 22 1	326		
					311 N-VA 8-10	/ V2A	5631637	3049 22 1	374		
264	/ St / F	5420316	5316 51 0	367	319 10	/ TG / F	5421931	5325 31 5	367		

02\_TBS\_Masterkatalog\_Länder\_2012 / en / 10/04/2012 (LLEExport\_01433)

Type	Dimensions/Colour/Div.	GTIN	Art. no.	Price	Page	Type	Dimensions/Colour/Div.	GTIN	Art. no.	Price	Page
319 8	/ TG / F	5421870	5325 30 7	/100 pc.	367	910 N 6x60 GRW	660/ PA	5228974	2349 07 8	/100 pc.	378
						910 N 8x40 GRW	840/ PA	5229032	2349 08 6		378
324 S-CU	/ Cu	5422532	5326 33 8		368	925 1	7031,7-33,7 / St / G	5385455	5040 11 6		304
324 S-FT	/ St / FT	5422419	5326 30 3		368	925 1 1/2	8846,3-48,3 / St / G	5385578	5040 15 9		304
324 S-VA	/ V2A	5422471	5326 31 1		368	925 1 1/4	8140,4-42,4 / St / G	5385516	5040 13 2		304
330 K	/ PA	5401599	5201 10 1		336	925 1/2	5619,3-21,3 / St / G	5385332	5040 07 8		304
						925 1/4	4811,5-13,5 / St / G	5385219	5040 03 5		304
						925 3/4	6224,9-26,9 / St / G	5385394	5040 09 4		304
						925 3/8	5215,2-17,2 / St / G	5385271	5040 05 1		304
356 100	10010	5230595	2360 10 1	/pc.	326	927 0	/ CuZn / N	5388517	5057 50 7		303
356 100	10010	5230595	2360 10 1		377	927 1	/ V2A	5388579	5057 51 5		303
356 50	5010	5230533	2360 05 5		326	927 2	/ V2A	5388630	5057 52 3		303
356 50	5010	5230533	2360 05 5		377	927 2 6-K	/ V2A	5699651	5057 59 9		392
						927 4	/ V2A	5388692	5057 55 8		303
364	297/ St / FT	5244219	3051 01 3		378	927 BAND-VA	230,3/ V2A	5805458	5057 92 2	/100 m	303
						927 SCH-K-VA	/ V2A	5805519	5057 93 0	/100 pc.	303
366 35	35/ St / FT	5388876	5059 35 6	/100 pc.	326	928	240/ CuZn / N	5385936	5040 50 7		304
366 50	50/ St / FT	5389057	5059 49 6		326	937 50	100/ St / FT	5385998	5043 01 8		306
370 H	55/ St / FT	5382690	5025 20 6		325	939	150/ St / G	5386056	5043 10 7		306
470 4-16	/ CuZn / N	5389231	5064 01 5		306	942 11	448-11 / Cu / N	5384557	5038 01 4		304
						942 15	5013-15 / Cu / N	5384618	5038 03 0		304
480 180		5412571	5240 03 4	/pc.	288	942 18	5216-18 / Cu / N	5384670	5038 05 7		304
480 250		5412755	5240 07 7		288	942 22	5519-22 / Cu / N	5384731	5038 07 3		304
480 350		5412694	5240 06 9		288	942 28	6324-28 / Cu / N	5384793	5038 08 1		304
						942 35	7130-35 / Cu / N	5384854	5038 11 1		304
481		5412816	5240 08 5		288	942 43	8139-43 / Cu / N	5384915	5038 13 8		304
						942 49	8644-49 / Cu / N	5384977	5038 15 4		304
482		5412632	5240 05 0		289	950 Z 1	6631,5-34,5 / Zn / G	5386353	5050 11 1		304
						950 Z 1 1/2	8446,5-49,5 / Zn / G	5386476	5050 15 4		304
484 M12	13/ St / F	5412991	5240 22 0		288	950 Z 1 1/4	7840,5-43,5 / Zn / G	5386414	5050 13 8		304
484 M16	17/ St / F	5413059	5240 23 9		288	950 Z 1 3/4	8851-54 / Zn / G	5386537	5050 17 0		304
484 M20	21/ St / F	5413110	5240 24 7		288	950 Z 1/2	5420-22,5 / Zn / G	5386230	5050 07 3		304
484 M24	25/ St / F	5413172	5240 25 5		288	950 Z 1/4	4512-14 / Zn / G	5386117	5050 03 0		304
						950 Z 2	9658,5-61,5 / Zn / G	5386599	5050 19 7		304
485 M10	11/ St / F	5413233	5240 30 1		288	950 Z 3/4	6125-28 / Zn / G	5386292	5050 08 1		304
485 M12	13/ St / F	5413295	5240 32 8		288	950 Z 3/8	5015,5-17,5 / Zn / G	5386179	5050 05 7		304
485 M16	17/ St / F	5413356	5240 33 6		288	951	120/ V2A	5386650	5051 50 9		305
485 M20	21/ St / F	5413417	5240 34 4		288	952 Z 1	7730,5-33,5 / St / FT	5386957	5052 11 4		305
						952 Z 1 1/2	9445,5-48,5 / St / FT	5387077	5052 15 7		305
555 7.6x380 SWUV	7.6 x 380 102/ PA	5896920	2332 78 4	/100 pc.	393	952 Z 1 1/4	8739,5-42,5 / St / FT	5387015	5052 13 0		305
						952 Z 1/2	6518,5-21,5 / St / FT	5386834	5052 07 6		305
708 30 HG	52/ St / G	5383659	5030 23 4			952 Z 2	10557-60 / St / FT	5387190	5052 18 1		305
708 30 SP	52/ St / G	5383413	5030 02 1		325	952 Z 3/4	7124-27 / St / FT	5386896	5052 09 2		305
708 40 HG	52/ St / G	5383710	5030 24 2			985 M6 25	25,4,3/ St / G	5250395	3133 02 8		378
710 30	52/ St / G	5383055	5028 03 5		325	985 M6 35	35,4,3/ St / G	5250456	3133 03 6		378
710 40	62/ St / G	5383116	5028 04 3		325	985 M8 35	3510/ St / G	5250579	3133 23 0		378
733 16 VA	14-16 6,5 x 10/ V2A	5116714	1362 01 1		352	1801 AH	Grey/ PS	5378617	5015 70 7	/pc.	297
733 21 VA	19-21 6,5 x 10/ V2A	5116837	1362 04 6		354	1801 KL1	212/ CuZn	5378730	5015 72 3		297
831 30	54/ St / FT	5383833	5032 03 2		324	1801 KL2	430/ CuZn	5378976	5015 80 4		297
831 30 M6	54/ St / FT	5383956	5032 23 7		324	1801 KL3	645/ CuZn	5379034	5015 81 2		297
831 40	65/ St / FT	5383895	5032 04 0		324	1801 RK25	/ St / G	5378853	5015 75 8		296
831 40 M6	65/ St / FT	5384014	5032 24 5		324	1801 RK30	/ St / G	5378792	5015 73 1		296
						1801 RK40	/ St / G	5455837	5015 77 4		297
832 30	55/ St / FT	5384137	5032 53 9		324	1801 RK95	/ St / G	5378914	5015 76 6		296
832 40	65/ St / FT	5384199	5032 54 7		324	1801 SCH	Grey/ PS	5378679	5015 71 5		297
						1801 VDE	Grey/ CuZn	5378556	5015 65 0		296
833 35	60/ St / FT	5384434	5033 03 9		324	1802 10 CU	40/ Cu	5002260	5015 84 2		301
835	/ St / FT	5433750	5033 20 9		324	1802 10 VA	40/ V2A	5002284	5015 86 6		301
						1802 12 CU	40/ Cu	5699354	5015 84 4		301
						1802 14 CU	40/ Cu	5699361	5015 84 7		301
853 200	200/ Cu	5885573	5331 00 8		369	1802 20 CU	40/ Cu	5699408	5015 84 9		301
853 300	300/ Cu	5423379	5331 01 3		369	1802 5 CU	40/ Cu	5002253	5015 83 0		301
853 400	400/ Cu	5885580	5331 01 7		369	1802 5 VA	40/ V2A	5002277	5015 85 4		301
						1802 6 CU	40/ Cu	5699330	5015 83 2		301
856	/ Cu	5423430	5331 50 1		369	1802 8 CU	40/ Cu	5699347	5015 83 6		301
						1802 AH 10	/ V2A	5033677	5015 88 4		301
						1802 AH 5	/ V2A	5033615	5015 88 0		301
910 N 10x50 GRW	1050/ PA	5229155	2349 10 8		378	1802 KL	/ V2A	5033738	5015 89 0		301
910 N 12x60 GRW	1260/ PA	5229216	2349 12 4		378	1804	/ CuZn	5378495	5015 55 3		299
910 N 5x25 GRW	525/ PA	5228851	2349 04 3		378	1804 AP	/ PE	5477839	5015 55 7		299
910 N 6x30 GRW	630/ PA	5228912	2349 05 1		378						

# Type listing

Structure of the GTIN: Country code **40** Manufacturer code **1219** Individual GTIN **5647589**

Type	Dimensions/Colour/Div.	GTIN	Art. no.	Price	Page	Type	Dimensions/Colour/Div.	GTIN	Art. no.	Price	Page
1804 UP	/ CuZn	5378433	5015 54 5	/pc.		2710 20	84/ St / FT	5372370	5001 21 8	/pc.	318
1805 2 FT	200110/ St / FT	5379096	5016 02 9		302	2710 25	89/ St / FT	5372431	5001 22 6		318
1805 2 FT	200110/ St / FT	5379096	5016 02 9		323	2730 20 FT	84/ St / FT	5372554	5001 40 4		318
1805 2 VA	200110/ V4A	5922216	5016 09 6		323	2730 20 VA	84/ V2A	5635475	5001 36 6		318
1805 2 VA	200110/ V4A	5922216	5016 09 6		302	2730 25 FT	89/ St / FT	5372615	5001 41 2		318
1805 4 FT	302212/ St / FT	5379157	5016 03 7		302						
1805 4 FT	302212/ St / FT	5379157	5016 03 7		323	2745 20 MS	/ CuZn / Cu	5372851	5001 56 0		318
1805 4 VA	302212/ V4A	5800354	5016 11 8		323	2745 20 MS	/ CuZn / Cu	5372851	5001 56 0		374
1805 4 VA	302212/ V4A	5800354	5016 11 8		302						
1805 6 FT	404314/ St / FT	5379218	5016 04 5		302	2760 20 FT	101/ St / FT	5372912	5001 64 1		318
1805 6 FT	404314/ St / FT	5379218	5016 04 5		323	2760 20 V4A	101/ V4A	5862697	5001 63 3		318
1805 6 VA	404314/ V4A	5922278	5016 12 6		323	2760 20 VA	101/ V2A	5635239	5001 61 7		318
1805 6 VA	404314/ V4A	5922278	5016 12 6		302	2760 25 FT	110/ St / FT	5372974	5001 66 8		318
						2760 25 V4A	110/ V4A	5901259	5001 67 2		318
1807	/ Al	5379270	5016 14 2		323						
						2760 B-20 FT	101/ St / FT	5754879	5001 74 9	/pc.	318
1808	/ CuZn	5378075	5015 01 4		299	2760 B-20 VA	101/ V2A	5752653	5001 62 5		318
1809	Grey/ CuZn	5378259	5015 07 3		297						
1809 30 AH	Grey/ PS	5800118	5015 20 0		298	5000	/ St / F	5415695	5304 00 8	/100 pc.	356
1809 A	Black/ V2A	5959427	5015 11 1		300						
1809 BG	Grey/ CuZn	5378372	5015 50 2		298	5001 DIN-FT	/ St / FT	5415879	5304 10 5		356
1809 M	Grey/ CuZn	5378310	5015 08 1		298	5001 DIN-FT+VA	/ St / FT	5858034	5304 10 7		356
1809 UP	/ CuZn	5378198	5015 06 5			5001 N-Cu	/ Cu	5817574	5304 17 2		357
						5001 N-FT	/ St / FT	5817512	5304 16 4		357
1810	/ St / F	5378136	5015 05 7		298	5001 N-VA	/ V2A	5892809	5304 17 6		357
										/100 pc.	
1811	250/ St / FT	5377894	5014 01 8		323	5001 ZN-CU	/ Zn / Cu	5415930	5304 11 3		356
1811 L	400/ St / FT	5377955	5014 02 6		323						
						5002 DIN-FT	/ St / FT	5416050	5304 20 2		356
1813 DIN	/ St / FT	5378013	5014 21 2		323	5002 N-VA	/ V2A	5892847	5304 27 0		357
1813 KL	/ St / FT	5901938	5014 42 5		322						
										/100 pc.	
1814 FT	/ St / FT	5105015	5014 46 8		322	5003	/ TG / FT	5416234	5304 31 8		357
1814 ST	/ St	5105077	5014 47 6		322						
						5004 DIN-FT 12	/ TG / FT	5416357	5304 40 7		362
1816 F-1000X1000	/ St / FT	5376996	5009 23 5		317	5004 DIN-FT 20	/ TG / FT	5416418	5304 50 4		362
1816 F-500X1000	/ St / FT	5376934	5009 22 7		317						
1816 F-500X500	/ St / FT	5376873	5009 21 9		317	5005 DIN-FT	/ St / F	5416470	5304 60 1		358
				/100 pc.		5005 N-FT	/ St / FT	5817758	5304 66 0		358
1818	/ St / FT	5377719	5012 01 5		322	5009	/ St / F	5416951	5304 97 0		358
				/pc.		5010 20 FT	/ St / FT	5503057	5304 52 0		363
1819 20	/ TG / FT	5242710	3041 20 4		313						
1819 20BP	/ TG / FT	5242772	3041 21 2		313	5011	/ St / FT	5417071	5304 99 7		322
1819 25	/ TG / FT	5242833	3041 25 5		313	5011	/ St / FT	5417071	5304 99 7		358
1819 25BP	/ TG / FT	5242956	3041 95 6		313						
						5011 VA M10	/ V4A	5629115	5334 93 4		323
1820 20	/ St	5243137	3042 20 0		314	5011 VA M10	/ V4A	5629115	5334 93 4		358
1820 25	/ St	5243199	3042 25 1		314	5011 VA M12	/ V4A	5959663	5334 94 2		323
						5011 VA M12	/ V4A	5959663	5334 94 2		358
				/100 pc.							
2056N SAS 12 VA	8-12 / V2A	5432432	1167 01 4		306						
2056N SAS 16 VA	12-16 / V2A	5432494	1167 02 2		306					/100 m	
2056N SAS 22 VA	16-22 / V2A	5432555	1167 03 0		306	5052 DIN 20X2.5	20 x 2,5/ St / FT	5680468	5019 34 0		310
2056N SAS 28 VA	22-28 / V2A	5432616	1167 04 9		306	5052 DIN 20X2.5	20 x 2,5/ St / FT	5680468	5019 34 0		330
2056N SAS 8 VA	4-8 / V2A	5432371	1167 00 6		306	5052 DIN 25X3	25 x 3/ St / FT	5694007	5019 34 2		310
						5052 DIN 25X3	25 x 3/ St / FT	5694007	5019 34 2		330
				/100 m		5052 DIN 30X3	30 x 3/ St / FT	5694014	5019 34 4		310
2066 2M F	25 x 12/ St / F	5046516	1117 02 5		306	5052 DIN 30X3	30 x 3/ St / FT	5694014	5019 34 4		330
2066 2M FS	25 x 12/ St / FS	5046578	1117 03 3		306	5052 DIN 30X3.5	30 x 3,5/ St / FT	5680475	5019 34 5		310
						5052 DIN 30X3.5	30 x 3,5/ St / FT	5680475	5019 34 5		330
						5052 DIN 30X3.5	30 x 3,5/ St / FT	5680482	5019 34 7		310
				/pc.		5052 DIN 30X3.5	30 x 3,5/ St / FT	5680482	5019 34 7		330
2500 20	/ St	5243311	3043 20 7		314	5052 DIN 30X4	30 x 4/ St / FT	5680499	5019 35 0		310
2500 25	/ St	5243373	3043 25 8		314	5052 DIN 30X4	30 x 4/ St / FT	5680499	5019 35 0		330
						5052 DIN 40X4	40 x 4/ St / FT	5680505	5019 35 5		310
2510 20	/ St	5717492	3043 31 2		314	5052 DIN 40X4	40 x 4/ St / FT	5680505	5019 35 5		330
						5052 DIN 40X5	40 x 5/ St / FT	5680512	5019 36 0		310
2520 20	/ St	5243793	3043 70 3		314	5052 DIN 40X5	40 x 5/ St / FT	5680512	5019 36 0		330
2520 25	/ St	5243854	3043 75 4		314	5052 V2A 30X3.5	30 x 3,5/ V2A	5800415	5018 50 1		310
						5052 V2A 30X3.5	30 x 3,5/ V2A	5800415	5018 50 1		330
2530 20	/ St	5243557	3043 40 1		314	5052 V4A 30X3.5	30 x 3,5/ V4A	5800477	5018 70 6		310
2530 25	/ St	5243618	3043 45 2		314	5052 V4A 30X3.5	30 x 3,5/ V4A	5800477	5018 70 6		330
						5052 V4A 30X3.5	30 x 3,5/ V4A	5022015	5018 73 0		310
2531 20	/ St	5642312	3043 90 8		314	5052 V4A 30X3.5	30 x 3,5/ V4A	5022015	5018 73 0		330
2535 20	/ St	5453796	3043 91 6		315					/pc.	
2535 25	/ St	5453970	3044 91 2		315						
						5700 A DIN		5400936	5106 02 8		376
2536 20	/ St	5643036	3044 90 4		315	5700 DIN		5400875	5106 00 1		376
2536 25	/ St	5642978	3044 83 1		315						
						5800 VA	/ V2A	5900436	5106 14 1		376
						5800 VZ	/ St / FS	5900375	5106 13 3		376

02\_TBS\_Masterkatalog\_Länder\_2012 / en / 10/04/2012 (LLEExport\_01433)

Type	Dimensions/Colour/Div.	GTIN	Art. no.	Price	Page	Type	Dimensions/Colour/Div.	GTIN	Art. no.	Price	Page
5900	/ st	5244813	3059 00 6	/pc.	378	FL 20-CU	20 x 2,5/ Cu	5382331	5021 80 4	/100 m	310
ASP-V11EI 4		5917717	5083 08 7		257	FL 20-CU	20 x 2,5/ Cu	5382331	5021 80 4		330
ASP-V24T 4		5917595	5083 06 0		257						
B 33020	228/ CuZn	6049080	6404 00 6	/100 pc.	306	FLD 110		5578413	5098 64 6	/pc.	270
B 33021	2610/ CuZn	6049202	6404 01 4		306	FLD 12		5578376	5098 60 3		269
						FLD 2-110		5578512	5098 85 9		272
						FLD 2-12		5578444	5098 80 8		271
						FLD 2-24		5578451	5098 81 6		271
						FLD 24		5578383	5098 61 1		269
						FLD 2-48		5578468	5098 82 4		271
C 25-B+C 0		5919391	5095 60 3	/pc.	164	FLD 2-5		5578529	5098 86 7		271
C 25-B+C 0		5919391	5095 60 3		195	FLD 48		5578390	5098 63 0		269
C 25-B+C 1		5542957	5095 60 6		156	FLD 5		5578369	5098 60 0		269
C 25-B+C 1		5542957	5095 60 6		179	FLD 60		5578406	5098 63 8		270
C 25-B+C 1		5542957	5095 60 6		195						
CNS 3-D-D	ENBlack	5952817	5092 70 1		211	FRD 110		5578338	5098 55 7		267
						FRD 12		5578291	5098 50 6		266
						FRD 2-24		5578420	5098 72 7		268
CNS-D-D	ENLight grey	5314837	5092 60 4		211	FRD 24		5578307	5098 51 4		266
						FRD 24 HF		5578352	5098 57 5		265
DLS-BS		5685333	5082 38 2		251	FRD 2-5		5578437	5098 79 4		268
						FRD 48		5578314	5098 52 2		266
DS-7 16 M/W		5030881	5093 17 1		247	FRD 5		5578284	5098 49 2		266
						FRD 5 HF		5578345	5098 57 1		265
DS-BNC M/M		5391098	5093 26 0		246						
DS-BNC M/W		5391036	5093 25 2		245	FS-V20		5397458	5099 80 3		289
DS-BNC W/W		5390978	5093 23 6		245						
DS-F M/W		5022732	5093 27 5		247	ISAV1000R	/ GFK	5004608	5408 84 9		386
DS-F W/W		5022619	5093 27 2		247	ISAV1000W	/ GFK	5009733	5408 85 2		386
DS-N M/W		5805991	5093 99 6		246					/100 m	
DS-N W/W		5962243	5093 98 8		246	isCon 750 LGR	Light grey	5888123	5407 99 5		388
						isCon 750 LGR	Light grey	5888154	5407 99 7		388
DS-SMA W/W		5867050	5093 27 7		247	isCon 750 SW	Black	5674573	5408 00 2		388
						isCon 750 SW	Black	5674627	5408 00 4		388
DS-TNC M/W		5087250	5093 27 0		246	isCon 750 SW	Black	5854265	5408 00 6		388
FC-D	ENPure white	5035053	5092 80 0		210	isCon AP1-16 VA	/ V2A	5674696	5408 02 6	/pc.	392
						isCon AP2-16 VA	/ V2A	5674702	5408 02 8		392
FC-ISDN-D	ENPure white	5047223	5092 81 2		211	isCon connect	/ V2A	5674689	5408 02 2		388
						isCon cut		5674641	5408 01 1		388
FC-RJD	ENPure white	5047254	5092 82 8		211	isCon DH	23-26 / GFK	5674863	5408 04 3	/100 pc.	390
FC-SAT-D	ENPure white	5035176	5092 81 6		210	isCon EPPA 004	140200/ Z-PP-P	5813781	5408 06 0		
FC-TAE-D	ENPure white	5035237	5092 82 4		210	isCon H 26 VA	/ V2A	5872696	5408 06 4	/pc.	389
FC-TV-D	ENPure white	5035114	5092 80 8		210	isCon H VA	/ V2A	5699668	5408 05 6		389
						isCon H280 26 PA	Light grey/ PA	5872757	5408 07 2		390
FDB-2 24-M	3222	5683339	5098 38 0		282	isCon H280 26 VA	/ V2A	5872764	5408 07 4		390
FDB-2 24-N	3222	5683384	5098 39 0		282	isCon H280 PA	Black/ PA	5674887	5408 04 9		390
FDB-3 24-M	3222	5683346	5098 38 2		282	isCon H280 VA	/ V2A	5674870	5408 04 7		390
FDB-3 24-N	3222	5683391	5098 39 2		282	isCon HS 26 PA	Light grey/ PA	5872702	5408 06 6		389
						isCon HS 26 VA	/ V2A	5872740	5408 06 8		389
						isCon HS PA	Black/ PA	5674917	5408 05 4		389
						isCon HS VA	/ V2A	5674726	5408 05 2		389
F-FIX-10		5070054	5403 10 3	/100 pc.	333	isCon HWS	/ PS	5813774	5408 05 8		
F-FIX-10B		5070061	5403 11 0		333	isCon IN connect	M16/ V2A	5864172	5408 02 4		391
F-FIX-132	110/ V2A	5613572	5403 33 0	/pc.	336	isCon IN PAE	49,9/ AI	5871569	5408 03 1		391
						isCon PAE	/ V2A	5674719	5408 03 6		388
F-Fix-132-300	300/ V2A	5813903	5403 33 3		336	isCon stripper	23-26	5674634	5408 00 9		388
F-FIX-16		5548713	5403 20 0	/100 pc.	333	isFang 3B-100	1000/ V2A	5670148	5408 96 8		337
F-FIX-16B		5110637	5403 20 5		333	isFang 3B-100	1000/ V2A	5670148	5408 96 8		391
F-FIX-B10	/ PP	5070085	5403 12 4		334	isFang 3B-100 AL	1000/ AI	5802433	5408 96 6		337
F-FIX-B10	/ PP	5070085	5403 12 4		385	isFang 3B-100 AL	1000/ AI	5802433	5408 96 6		391
F-FIX-B16	/ PP	5548959	5403 23 5		333	isFang 3B-100-A	1026/ V2A	5859550	5408 93 0		337
F-FIX-B16	/ PP	5548959	5403 23 5		384	isFang 3B-100-A	1026/ V2A	5859550	5408 93 0		391
F-FIX-B16 3B	25/ PP	5926320	5403 23 8		338	isFang 3B-150	1500/ V2A	5674931	5408 96 9		337
F-FIX-B16 3B	25/ PP	5926320	5403 23 8		392	isFang 3B-150	1500/ V2A	5674931	5408 96 9		391
						isFang 3B-150 AL	1500/ AI	5802440	5408 96 7		337
F-FIX-BASIS	/ PP	5034933	5403 32 4	/pc.	332	isFang 3B-150 AL	1500/ AI	5802440	5408 96 7		391
F-FIX-JUNIOR	1000/ AI	5034872	5403 30 8		332	isFang 3B-150-A	1500/ V2A	5859567	5408 93 2		337
						isFang 3B-150-A	1500/ V2A	5859567	5408 93 2		391
F-FIX-KL	/ V2A	5548775	5403 21 9		334	isFang 3B-G1	270/ V2A	5674948	5408 97 1		338
F-FIX-S10		5070078	5403 11 7		334	isFang 3B-G1	270/ V2A	5674948	5408 97 1		392
F-FIX-S10		5070078	5403 11 7		384	isFang 3B-G2	340/ V2A	5674979	5408 97 2		338
F-FIX-S16		5548898	5403 22 7		333	isFang 3B-G2	340/ V2A	5674979	5408 97 2		392
F-FIX-S16		5548898	5403 22 7		338	isFang 3B-G3	430/ V2A	5674986	5408 97 3		338
F-FIX-S16		5548898	5403 22 7		384	isFang 3B-G3	430/ V2A	5674986	5408 97 3		392
F-FIX-S16		5548898	5403 22 7		392	isFang 4000	1240/ GFK	5670056	5408 94 2		337
						isFang 4000	1240/ GFK	5670056	5408 94 2		391

# Type listing

Structure of the GTIN: Country code 40    Manufacturer code 1219    Individual GTIN 5647589

Type	Dimensions/Colour/Div.	GTIN	Art. no.	Price	Page	Type	Dimensions/Colour/Div.	GTIN	Art. no.	Price	Page
isFang 4000 AL	1240/ GFK	5785330	5408 94 3	/pc.	337	MB 1		5415732	5096 64 8	/pc.	205
isFang 4000 AL	1240/ GFK	5785330	5408 94 3		391	MB 1+FS		5415749	5096 64 9		165
isFang 6000	3340/ GFK	5670063	5408 94 6		337	MB 1+FS		5415749	5096 64 9		196
isFang 6000	3340/ GFK	5670063	5408 94 6		391	MB 1+FS		5415749	5096 64 9		205
isFang 6000 AL	3340/ GFK	5785347	5408 94 7		337	MB 1+NPE		5415770	5096 65 0		165
isFang 6000 AL	3340/ GFK	5785347	5408 94 7		391	MB 1+NPE		5415770	5096 65 0		196
isFang IN 4000	1325/ GFK	5871613	5408 93 4		338	MB 1+NPE		5415770	5096 65 0		205
isFang IN 4000	1325/ GFK	5871613	5408 93 4		393	MB 1+NPE+FS		5415787	5096 65 1		165
isFang IN 6000	3325/ GFK	5871620	5408 93 6		338	MB 1+NPE+FS		5415787	5096 65 1		196
isFang IN 6000	3325/ GFK	5871620	5408 93 6		393	MB 1+NPE+FS		5415787	5096 65 1		205
isFang IN-A 4000	1325/ GFK	5871668	5408 93 8		337						
isFang IN-A 4000	1325/ GFK	5871668	5408 93 8		390	MB 2		5415794	5096 65 3		165
isFang IN-A 6000	3325/ GFK	5871675	5408 94 0		337	MB 2		5415794	5096 65 3		196
isFang IN-A 6000	3325/ GFK	5871675	5408 94 0		390	MB 2		5415794	5096 65 3		205
isFang TR100	40/ V2A	5670100	5408 95 6		339	MB 2+FS		5415800	5096 65 4		165
isFang TR100	40/ V2A	5670100	5408 95 6		393	MB 2+FS		5415800	5096 65 4		196
isFang TR100 100	100/ V2A	5849360	5408 95 5		339	MB 2+FS		5415800	5096 65 4		205
isFang TR100 100	100/ V2A	5849360	5408 95 5		394	MB 2+NPE		5067481	5096 65 5		165
isFang TR100 200	200/ V2A	5849391	5408 95 7		339	MB 2+NPE		5067481	5096 65 5		196
isFang TR100 200	200/ V2A	5849391	5408 95 7		394	MB 2+NPE		5067481	5096 65 5		205
isFang TR100 300	300/ V2A	5849407	5408 95 9		339	MB 2+NPE+FS		5067498	5096 65 7		165
isFang TR100 300	300/ V2A	5849407	5408 95 9		394	MB 2+NPE+FS		5067498	5096 65 7		196
isFang TS40-50	40/ V2A	5670117	5408 95 8		339	MB 2+NPE+FS		5067498	5096 65 7		205
isFang TS40-50	40/ V2A	5670117	5408 95 8		394						
isFang TS50-60	30/ V2A	5670124	5408 96 0			MB 3		5067504	5096 66 5		165
isFang TS50-60	30/ V2A	5670124	5408 96 0		339	MB 3		5067504	5096 66 5		196
isFang TS50x50	30/ V2A	5670131	5408 96 4			MB 3		5067504	5096 66 5		205
isFang TS50x50	30/ V2A	5670131	5408 96 4		339	MB 3+FS		5067535	5096 66 7		165
isFang TW200	300/ V2A	5670094	5408 95 4		338	MB 3+FS		5067535	5096 66 7		196
isFang TW200	300/ V2A	5670094	5408 95 4		393	MB 3+FS		5067535	5096 66 7		205
isFang TW30	30/ V2A	5670087	5408 95 2		338	MB 3+NPE		5067542	5096 66 9		165
isFang TW30	30/ V2A	5670087	5408 95 2		393	MB 3+NPE		5067542	5096 66 9		196
isFang TW80	80/ V2A	5670070	5408 95 0		338	MB 3+NPE		5067542	5096 66 9		205
isFang TW80	80/ V2A	5670070	5408 95 0		393	MB 3+NPE+FS		5067559	5096 67 1		165
						MB 3+NPE+FS		5067559	5096 67 1		196
						MB 3+NPE+FS		5067559	5096 67 1		205
ISO-A-1030	1080/ AI	5770497	5408 82 0		387	MB 3+NPE+FS		5067559	5096 67 1		205
ISO-A-500	500/ AI	5542773	5408 80 6		387						
ISO-A-800	800/ AI	5542834	5408 81 4		387	MB 4		5067566	5096 68 0		165
						MB 4		5067566	5096 68 0		196
						MB 4		5067566	5096 68 0		205
ISOLAB	D/GB	5921738	5096 81 2		292	MB 4+FS		5067597	5096 68 2		165
KB MB		5709350	5089 66 0		206	MB 4+FS		5067597	5096 68 2		196
KB MB		5709367	5089 66 2		206	MB 4+FS		5067597	5096 68 2		205
						MB 50-3+NPE		5425144	5096 67 5		152
KOAX B-E2 MF-C		5684916	5082 41 2		250	MB 50-3+NPE+FS		5425151	5096 67 7		152
KOAX B-E2 MF-F		5684855	5082 42 0		250						
						MB25-3+NPE		5871200	5096 67 2		191
KoaxB-E2 FF-F		5685074	5082 42 2		251	MB25-3+NPE+FS		5871248	5096 67 3		191
LC 63		5509899	5096 97 0		143	MB-FS		5813484	5096 69 3		
						MB-FS		5813484	5096 69 3		164
						MB-FS		5813484	5096 69 3		197
LE ERDER FT	1000/ St / FT	5018001	5000 29 7		312						
LE ERDER FT	1500/ St / FT	5617358	5000 30 0		312	MB-SG	Blue/ PA	5616375	5096 69 5		
LE ERDER V4A	1500/ V4A	5708834	5000 33 5		312	MB-SG	Blue/ PA	5616375	5096 69 5		164
						MB-SG	Blue/ PA	5616375	5096 69 5		206
LE HAMMER-AC	/ St	5111641	3043 61 8		315	MC 125-B NPE		5966449	5096 86 3		140
LE HAMMER-B	/ St	5087137	3043 61 4		315						
LE HAMMER-B-II	/ St	5421627	3043 62 8		315	MC 50-B 0 VDE		5480730	5096 82 0		142
LE HAMMER-H	/ St	5087076	3043 61 0		315	MC 50-B 0-OS		5051428	5096 82 5		142
LE HAMMER-SDS-M	/ St	5111160	3043 60 2		315	MC 50-B 3		5077046	5096 87 6		141
LE HAMMER-W	/ St	5617419	3043 60 6		315	MC 50-B 3+1		5077084	5096 87 8		140
						MC 50-B U VDE		5480792	5096 83 9		143
						MC 50-B VDE		5966388	5096 84 7		141
						MC 50-B-OS		5051411	5096 85 1		141
LE KOPF	/ St / FT	5617297	3042 30 8		313						
LE SPITZE	/ St / FT	5617235	3041 40 9		313	MC V3	/ Cu	5531135	5096 88 4		143
						MC V4	/ Cu	5531197	5096 88 6		143
LFC		5425182	5096 78 6		292	MCD 125-B NPE		5541394	5096 86 5		136
						MCD 50-B		5541158	5096 84 9		137
LSA-A-LEI	Grey	5525134	5084 00 8		241	MCD 50-B 0		5544517	5096 82 2		142
LSA-BF-180		5525370	5084 02 4		242	MCD 50-B 0-OS		5051473	5096 82 7		142
LSA-BF-24		5525431	5084 02 8		242	MCD 50-B 3		5077077	5096 87 7		137
LSA-B-MAG		5525318	5084 02 0		241	MCD 50-B 3+1		5077091	5096 87 9		136
LSA-E		5525493	5084 03 2		242	MCD 50-B 3+1-OS		5288299	5096 83 6		136
LSA-E-LEI	Red	5525257	5084 01 6		241	MCD 50-B 3+1-VG		5362036	5096 87 5		138
LSA-G	Light grey/ PA	5110750	5084 04 8		243	MCD 50-B 3-OS		5288282	5096 83 5		137
LSA-M	/ St	5525554	5084 03 6		242	MCD 50-B 3-VG		5362029	5096 87 4		139
LSA-T-LEI	White	5525196	5084 01 2		241	MCD 50-B-OS		5051466	5096 85 2		137
LSA-TOOL		5525615	5084 04 0		243						
						MDP-2 D-12-T-10		5787372	5098 41 5		278
MB 1		5415732	5096 64 8		165	MDP-2 D-24-T		5406860	5098 42 2		275
MB 1		5415732	5096 64 8		196	MDP-2 D-24-T-10		5787389	5098 42 5		279

02\_TBS\_Masterkatalog\_Länder\_2012 / en / 10/04/2012 (LLExpert\_01433)

Type	Dimensions/Colour/Div.	GTIN	Art. no.	Price	Page	Type	Dimensions/Colour/Div.	GTIN	Art. no.	Price	Page
MDP-2 D-48-T		5406891	5098 44 2	/pc.	276	RD 8-FT	/ St / FT	5381556	5021 08 1	/100 m	330
MDP-2 D-5-T		5406839	5098 40 4		274	RD 8-PVC	Cream8/ Al	5067474	5021 33 2		311
MDP-3 D-24-T		5406877	5098 42 7		275	RD 8-PVC	Cream8/ Al	5067474	5021 33 2		331
MDP-3 D-48-T		5406907	5098 44 6		276	RD 8-V2A	/ V2A	5680529	5021 23 5		311
MDP-3 D-5-T		5406846	5098 40 7		274	RD 8-V2A	/ V2A	5680529	5021 23 5		331
MDP-4 D-12-T-10		5773610	5098 41 9		278	RD 8-V4A	/ V4A	5680574	5021 64 4		311
MDP-4 D-24-EX		5848523	5098 43 2		284	RD 8-V4A	/ V4A	5680574	5021 64 4		331
MDP-4 D-24-T		5406884	5098 43 1		275						
MDP-4 D-24-T-10		5625131	5098 43 3		279						
MDP-4 D-48-EX		5848530	5098 45 2		284						
MDP-4 D-48-T		5406914	5098 45 0		276	RJ11-TELE 4-C		5680536	5081 92 0	/pc.	237
MDP-4 D-5-EX		5848516	5098 41 2		284	RJ11-TELE 4-C		5680536	5081 92 0		238
MDP-4 D-5-T		5406853	5098 41 1		274	RJ11-TELE 4-F		5680413	5081 93 9		238
MDP-4 D-5-T-10		5625124	5098 41 3		277						
				/VPE		RJ45 S-ATM 8-F		5462439	5081 79 3		250
						RJ45 S-E100 4-B		5239956	5081 72 6		252
MK-B		5461111	5091 32 2		293	RJ45 S-E100 4-C		5239895	5081 73 4		252
MK-B		5461111	5091 32 2		376	RJ45 S-E100 4-F		5239833	5081 74 2		252
						RJ45-ISDN 4-C-G		5889458	5081 54 8		239
						RJ45S-V24T 4-F		5502630	5081 64 5		253
						RJ45S-V24T 8-F		5502692	5081 64 7		253
M-Quick M25 SW	Jet black 20-25 / PA	5505396	2153 78 7	/100 pc.	390	RJ45-TELE 4-C		5791119	5081 96 3		238
M-Quick M32 LGR	Light grey 25-32 / PA	5741671	2153 73 4		390	RJ45-TELE 4-F		5791058	5081 97 1		238
				/pc.						/100 pc.	
ND-CAT6A/EA		5614364	5081 80 0		250	RK-FIX	/ St / FT	5433682	5316 45 0		365
						RK-FIX CU	/ V2A / Cu	5433736	5316 46 8		365
						RK-FIX VA	/ V2A	5433729	5316 45 9		365
PCS		5461296	5091 43 8		293						
PCS		5461296	5091 43 8		376						
				/pc.						/100 m	
PCS-CS-D	EN	5461654	5091 68 3		293	S 11-CU	10,5/ Cu	5836209	5021 65 4		
PCS-CS-D	EN	5461654	5091 68 3		377	S 11-CU	10,5/ Cu	5836209	5021 65 4		
PCS-CS-GB	GB	5896111	5091 69 1		293	S 9-CU	9/ Cu	5382218	5021 65 0		
PCS-CS-GB	GB	5896111	5091 69 1		377	S 9-CU	9/ Cu	5382218	5021 65 0		
				/VPE							
PCSH		5461470	5091 52 7		293						
PCSH		5461470	5091 52 7		377						
				/pc.						/pc.	
PS 2-B+C/TT+TNS		5759782	5089 74 8		167	SC-TELE 4-C-G		5834793	5081 68 8		237
						SD09-V11 9		5916277	5080 06 1		256
						SD09-V24 9		5915973	5080 05 3		255
PS3-B+C TNC		5405528	5089 75 4		168						
PS3-B+C TNC+FS		5405535	5089 75 6		168	SD15-V24 15		5916031	5080 15 0		255
PS3-B+C-320		5806813	5089 75 5		168						
PS3-B+C-320+FS		5816614	5089 75 7		168	SD25-V11 25		5916390	5080 28 2		256
PS3-VA TNC		5405566	5089 76 8		170	SD25-V24 25		5916215	5080 27 4		255
PS3-VA TNC+FS		5405580	5089 77 5		170						
PS4-B+C TNS+FS		5405559	5089 76 3		167	SD-Fix	/ V2A	5670735	5403 33 5		335
PS4-B+C TT+TNS		5405542	5089 76 1		167						
PS4-VA TT+FS		5405597	5089 77 7		169						
PS4-VA TT+TNS		5405573	5089 77 0		169						
				/100 pc.						/100 pc.	
P-TK		5017387	5086 01 9		207	SQ M6	Light grey M6/ PC	5016069	2146 50 9		389
P-TK+SAT		5017448	5086 02 3		207	SQ PP	630/ PA	5016182	2351 70 6		389
P-TK+TV		5017509	5086 02 7		207						
				/100 m							
RD 10	/ St / FT	5381617	5021 10 3		310						
RD 10	/ St / FT	5381617	5021 10 3		330						
RD 10-ALU	/ Al	5381976	5021 30 8		311	S-UHF M/W		5390732	5093 02 3	/pc.	245
RD 10-ALU	/ Al	5381976	5021 30 8		331	S-UHF W/W		5390671	5093 01 5		245
RD 10-CU	/ Cu	5382096	5021 50 2		311						
RD 10-CU	/ Cu	5382096	5021 50 2		331	TKS-B		5578277	5097 97 6		265
RD 10-PVC	Black 10/ st / FT	5381730	5021 16 2		310						
RD 10-PVC	Black 10/ st / FT	5381730	5021 16 2		330						
RD 10-V2A	/ V2A	5801375	5021 22 7		311						
RD 10-V2A	/ V2A	5801375	5021 22 7		331	TrayFix		5738428	5403 10 0	/100 pc.	334
RD 10-V2A	/ V2A	5680567	5021 23 9		311	TrayFix		5738428	5403 10 0		377
RD 10-V2A	/ V2A	5680567	5021 23 9		331						
RD 10-V4A	/ V4A	5902058	5021 64 2		311						
RD 10-V4A	/ V4A	5902058	5021 64 2		331						
RD 10-V4A	/ V4A	5680581	5021 64 7		311	TV 4+1		5022978	5083 40 0	/pc.	248
RD 10-V4A	/ V4A	5680581	5021 64 7		331						
						ÜSM-A		5080886	5092 45 1		212
RD 8-ALU	/ Al	5381914	5021 28 6		311	ÜSM-A-150		5475804	5092 46 6		212
RD 8-ALU	/ Al	5381914	5021 28 6		331	ÜSM-A-2		5247098	5092 46 0		212
RD 8-ALU-T	/ Al	5901273	5021 29 4		311	ÜSM-A-4		5613596	5092 47 2		212
RD 8-ALU-T	/ Al	5901273	5021 29 4		331	ÜSM-A-TW		5613589	5092 47 0		212
RD 8-CU	/ Cu	5382034	5021 48 0		311						
RD 8-CU	/ Cu	5382034	5021 48 0		331						
RD 8-FT	/ St / FT	5381556	5021 08 1		310	ÜSS 45-A-ALU	Aluminium painted	5006220	6117 46 7		213

# Type listing

Structure of the GTIN: Country code **40** Manufacturer code **1219** Individual GTIN **5647589**

Type	Dimensions/Colour/Div.	GTIN	Art. no.	Price	Page	Type	Dimensions/Colour/Div.	GTIN	Art. no.	Price	Page
				/pc.						/pc.	
ÜSS 45-A-RW	Pure white	6117611	6117 46 5		213	V20-C U-2 AS		5393856	5096 41 3		206
ÜSS 45-O-ALU	Aluminium painted	5006213	6117 47 5		213	V20-C U-2 PH		5464457	5096 63 7		232
ÜSS 45-O-RW	Pure white	6117673	6117 47 3		213	V20-C U-2 PH+FS		5464464	5096 63 9		232
						V20-C U-3 AS		5393917	5096 42 1		166
						V20-C U-3 AS		5393917	5096 42 1		197
V 20-C 3+NPE+FS		5616382	5094 76 4		177	V20-C U-3 AS		5393917	5096 42 1		206
						V20-C U-3 FS-SÜ		5393559	5096 35 9		165
V 50-B+C 0-150	200	5681939	5094 40 0		151	V20-C U-3 FS-SÜ		5393559	5096 35 9		196
						V20-C U-3 FS-SÜ		5393559	5096 35 9		205
V10 COMPACT 150		5246268	5093 37 8		200	V20-C U-3+NPE		5063407	5096 37 0		166
V10 COMPACT 255		5076551	5093 38 0		200	V20-C U-3+NPE		5063407	5096 37 0		197
V10 COMPACT 385		5126041	5093 38 4		200	V20-C U-3+NPE		5063407	5096 37 0		206
V10 COMPACT-AS		5299448	5093 39 1		200	V20-C U-3+NPE-AS		5247104	5096 37 2		166
						V20-C U-3+NPE-AS		5247104	5096 37 2		197
V10-C 0-150		5158103	5093 40 0		204	V20-C U-3+NPE-AS		5247104	5096 37 2		206
V10-C 0-280		5012825	5093 40 2		204	V20-C U-3PH-Y		5299455	5096 64 7		232
V10-C 0-320		5012832	5093 40 4		204	V20-C U-3PH-Y-FS		5648499	5096 64 6		232
V10-C 0-385		5004660	5093 40 6		204	V20-C U-4 AS		5393979	5096 44 8		166
V10-C 1+NPE-280		5382799	5093 41 8		202	V20-C U-4 AS		5393979	5096 44 8		197
V10-C 3+NPE		5363903	5094 92 0		202	V20-C U-4 AS		5393979	5096 44 8		206
V10-C 3+NPE+FS		5363941	5094 93 1		202	V20-C U-4 FS-SÜ		5393610	5096 36 7		165
V10-C 3+NPE-320		5363934	5094 92 4		203	V20-C U-4 FS-SÜ		5393610	5096 36 7		196
						V20-C U-4 FS-SÜ		5393610	5096 36 7		205
V20-C 0-150	200	5519133	5096 70 7		193	V20-C3+NPE400+FS		5871262	5094 90 2		191
V20-C 0-280	350	5396918	5099 60 9		193	V20-VA 0		5807612	5099 61 3		195
V20-C 0-300PV	300	5708902	5099 61 1		231	V20-VA 1-385		5406716	5099 47 5		192
V20-C 0-320-SP	420	5570318	5099 84 8		193						
V20-C 0-335	420	5481270	5099 85 0		194	V25-B+C 0-150	200	5965664	5097 08 8		163
V20-C 0-385	505	5396857	5099 59 5		194	V25-B+C 0-280	350	5394099	5097 05 3		163
V20-C 0-440	585	5942498	5099 70 6		194	V25-B+C 0-320	420	5711551	5097 29 0		163
V20-C 0-500PV	500	5708933	5099 70 8		231	V25-B+C 0-385	505	5766636	5097 06 1		163
V20-C 0-550	745	5396970	5099 61 7		194	V25-B+C 0-450PV	450	5708896	5097 06 5		231
V20-C 0-75	100	5396734	5099 57 9		193	V25-B+C 1+NPE		5382850	5094 45 7		156
V20-C 1+FS-280		5406679	5094 72 7		182	V25-B+C 1+NPE+FS		5374886	5094 44 4		157
V20-C 1+NPE+FS		5382911	5094 76 0		180	V25-B+C 1-150		5457473	5094 40 1		155
V20-C 1+NPE-150		5382966	5094 63 9		176	V25-B+C 1-280		5406556	5094 41 8		158
V20-C 1+NPE-280		5382973	5094 65 0		179	V25-B+C 1-385		5406563	5094 43 1		162
V20-C 1+NPE-385		5382980	5094 66 6		185	V25-B+C 1NPE150		5382843	5094 44 8		154
V20-C 1-150		5406617	5094 67 7		178	V25-B+C 2+NPE		5239826	5094 46 0		156
V20-C 1-280		5406594	5094 61 8		181	V25-B+C 2-150		5382812	5094 40 3		155
V20-C 1-385		5406655	5094 70 3		186	V25-B+C 2-280		5382829	5094 42 1		158
V20-C 1-550		5406662	5094 71 3		188	V25-B+C 2-385		5382836	5094 43 4		162
V20-C 2+AS-280		5393672	5096 37 5		183	V25-B+C 2-PH900	900	5478690	5097 45 7		221
V20-C 2+FS-280		5374923	5094 63 2		182	V25-B+C 2PHFS900	900	5709138	5097 45 8		221
V20-C 2+FS-550		5374985	5094 63 6		189	V25-B+C 3+AS		5945314	5097 18 5		159
V20-C 2+NPE+FS		5240235	5094 76 2		180	V25-B+C 3+NPE		5239864	5094 46 3		156
V20-C 2+NPE-150		5240044	5094 64 1		176	V25-B+C 3+NPE+AS		5617532	5097 43 2		157
V20-C 2+NPE-280		5240068	5094 65 3		179	V25-B+C 3+NPE-FS		5239949	5094 51 0		157
V20-C 2+NPEFS15		5240228	5094 75 0		177	V25-B+C 3-280		5239734	5094 42 3		158
V20-C 2-150		5382881	5094 67 9		178	V25-B+C 3-385		5239758	5094 43 7		162
V20-C 2-280		5382867	5094 62 1		181	V25-B+C 3-FS280		5239925	5094 49 0		159
V20-C 2-385		5382898	5094 70 4		186	V25-B+C 3NPE150		5239819	5094 45 4		154
V20-C 2-550		5382904	5094 71 4		188	V25-B+C 3NPE385		5239888	5094 47 8		161
V20-C 2-PH-1000	1000	5478669	5094 61 7		223	V25-B+C 3NPEAS38		5542056	5097 11 1		161
V20-C 2PH-600	600	5708889	5094 61 3		222	V25-B+C 3NPEFS38		5239994	5094 52 6		161
V20-C 2PHFS-1000	1000	5709114	5094 61 5		223	V25-B+C 3-PH900	900	5478683	5097 44 7		221
V20-C 2PHFS-600	600	5709077	5094 57 2		222	V25-B+C 3PHFS900	900	5709121	5097 44 8		221
V20-C 3+AS-280		5393733	5096 38 3		183	V25-B+C 4+AS280		5394211	5097 19 3		159
V20-C 3+FS-280		5240198	5094 73 1		182	V25-B+C 4+FS-SÜ		5394396	5097 35 5		160
V20-C 3+FS-385		5240280	5094 78 0		187	V25-B+C 4-280		5239741	5094 42 6		158
V20-C 3+FS-550		5240334	5094 79 2		189	V25-B+C 4-385		5239765	5094 44 0		162
V20-C 3+FS-SÜ		5393191	5096 25 1		184	V25-B+C 4-FS280		5239932	5094 49 3		159
V20-C 3+NPE+AS		5617471	5096 39 7		180	V25-B+C 4-FS-G		5240013	5094 55 2		160
V20-C 3+NPE+FS		5240242	5094 76 5		180						
V20-C 3+NPE-150		5240051	5094 64 4		176	V50-B+C 0-280	350	5361954	5093 72 4		151
V20-C 3+NPE-280		5240099	5094 65 6		179	V50-B+C 0-300PV	300	5708841	5093 72 6		231
V20-C 3+NPE-385		5240112	5094 66 8		185	V50-B+C 1+NPE		5688426	5093 65 3		148
V20-C 3+NPE400		5871255	5094 90 0		191	V50-B+C 1+NPE+FS		5688433	5093 66 1		149
V20-C 3+NPEFS38		5240303	5094 78 8		185	V50-B+C 2+NPE		5836797	5093 65 5		148
V20-C 3-150		5240129	5094 68 0		178	V50-B+C 2-PH600	600	5478553	5093 62 8		220
V20-C 3-280		5240020	5094 62 4		181	V50-B+C 2PHFS600	600	5709060	5093 62 9		220
V20-C 3-385		5240150	5094 70 5		186	V50-B+C 3+FS280		5361916	5093 64 3		150
V20-C 3-550		5240174	5094 71 5		188	V50-B+C 3+NPE		5425120	5093 65 4		148
V20-C 3-PH-1000	1000	5478621	5094 60 8		223	V50-B+C 3+NPE+FS		5425137	5093 66 2		149
V20-C 3PH-600	600	5708872	5094 60 5		222	V50-B+C 3-280		5361893	5093 62 7		150
V20-C 3PHFS-1000	1000	5648482	5094 57 4		223	V50-B+C 3-PH600	600	5478546	5093 62 3		220
V20-C 3PHFS-600	600	5709084	5094 57 6		222	V50-B+C 3PHFS600	600	5709022	5093 62 5		220
V20-C 4+AS-280		5393795	5096 39 1		183	V50-B+C 4		5361909	5093 63 1		150
V20-C 4+FS-280		5240204	5094 73 4		182	V50-B+C 4+FS		5361923	5093 64 7		150
V20-C 4+FS-550		5240341	5094 79 5		189						
V20-C 4+FS-SÜ		5393252	5096 27 8		184	VB-MDP 10-MD	/ Cu	5410461	5098 47 0		280
V20-C 4-280		5240037	5094 62 7		181	VB-MULTIBASE250		5237358	5089 65 5		164
V20-C 4-385		5240167	5094 70 8		186						
V20-C 4-550		5240181	5094 71 8		188	VB-V10 COMPACT-2		5237341	5089 65 0		201
V20-C U-2 AS		5393856	5096 41 3		166	VB-V10 COMPACT-4		5299400	5089 65 2		201
V20-C U-2 AS		5393856	5096 41 3		197						

02\_TBS\_Masterkatalog\_Länder\_2012 / en / 10/04/2012 (LLEExport\_01433)



Type	Dimensions/Colour/Div.	GTIN	Art. no.	Price	Page
				/pc.	
VF110-AC DC	150	5578154	5097 63 1		215
VF110-AC DC	150	5578154	5097 63 1		260
VF110-AC DC-FS	200150	5578192	5097 84 6		216
VF110-AC DC-FS	200150	5578192	5097 84 6		262
VF12-AC DC	13,5	5578116	5097 45 3		214
VF12-AC DC	13,5	5578116	5097 45 3		259
VF12-AC/DC-FS	1813,5	5736561	5097 45 4		261
VF2-110-AC/DCFS	150200	5578253	5097 93 5		217
VF2-110-AC/DCFS	150200	5578253	5097 93 5		263
VF2-230-AC/DC-FS	255350	5578260	5097 93 9		217
VF2-230-AC/DC-FS	255350	5578260	5097 93 9		263
VF2-24-AC/DC-FS	3446	5578246	5097 93 1		217
VF2-24-AC/DC-FS	3446	5578246	5097 93 1		263
VF230-AC/DC	255	5578161	5097 65 0		215
VF230-AC/DC	255	5578161	5097 65 0		260
VF230-AC-FS	255	5578215	5097 85 8		216
VF230-AC-FS	255	5578215	5097 85 8		262
VF24-AC/DC	34	5578123	5097 60 7		214
VF24-AC/DC	34	5578123	5097 60 7		259
VF24-AC/DC-FS	4634	5578185	5097 82 0		216
VF24-AC/DC-FS	4634	5578185	5097 82 0		261
VF48-AC/DC	60	5578130	5097 61 5		214
VF48-AC/DC	60	5578130	5097 61 5		259
VF48-AC/DC-FS	8060	5812258	5097 82 2		261
VF60-AC/DC	80	5578147	5097 62 3		214
VF60-AC/DC	80	5578147	5097 62 3		259
VF60-AC/DC-FS	11080	5812265	5097 82 4		262
VF-FS		5813521	5098 47 5		280
VG 3-B TNC		5531074	5089 21 2		139
VG 4-B TNS+TT		5531012	5089 20 0		138
VG LM	/ PA	5047155	5088 87 9		164
VG-BC DC-MSFS600	600	5835646	5088 69 5		227
VG-BC DC-MSFS900	900	5835653	5088 69 6		227
VG-BC DCPH900-21	900	5872641	5088 62 5		224
VG-BC DCPH900-31	900	5872658	5088 62 9		224
VG-BC DCPH-MS600	600	5613725	5088 69 3		226
VG-BC DCPH-MS900	900	5613718	5088 69 2		226
VG-BC DCPH-Y600	600	5709008	5088 67 6		229
VG-BC DCPH-Y900	900	5709015	5088 67 8		229
VG-C DCPH1000-21	1000	5829461	5088 64 6		224
VG-C DCPH1000-31	1000	5829478	5088 64 8		224
VG-C DC-PH1000-4	1000	5704010	5088 70 3		228
VG-C DCPH1000-4K	1000	5780700	5088 65 0		226
VG-C DCPH1000-4S	1000	5780717	5088 65 1		225
VG-C DCPH1000-6S	1000	5780724	5088 65 2		225
VG-C DC-PH-21	1000	5890805	5088 60 5		230
VG-C DC-PH-31	1000	5890812	5088 60 9		230
VG-C DC-PH-MS	1000	5371090	5088 69 4		230
VG-C DCPH-MS1000	1000	5613701	5088 69 1		226
VG-C DC-PH-Y	1000	5473206	5088 69 9		230
VG-C DCPH-Y1000	1000	5708964	5088 67 2		229
VG-C DCPH-Y600	600	5708957	5088 67 0		229
ZSF		5518419	2362 97 0		377

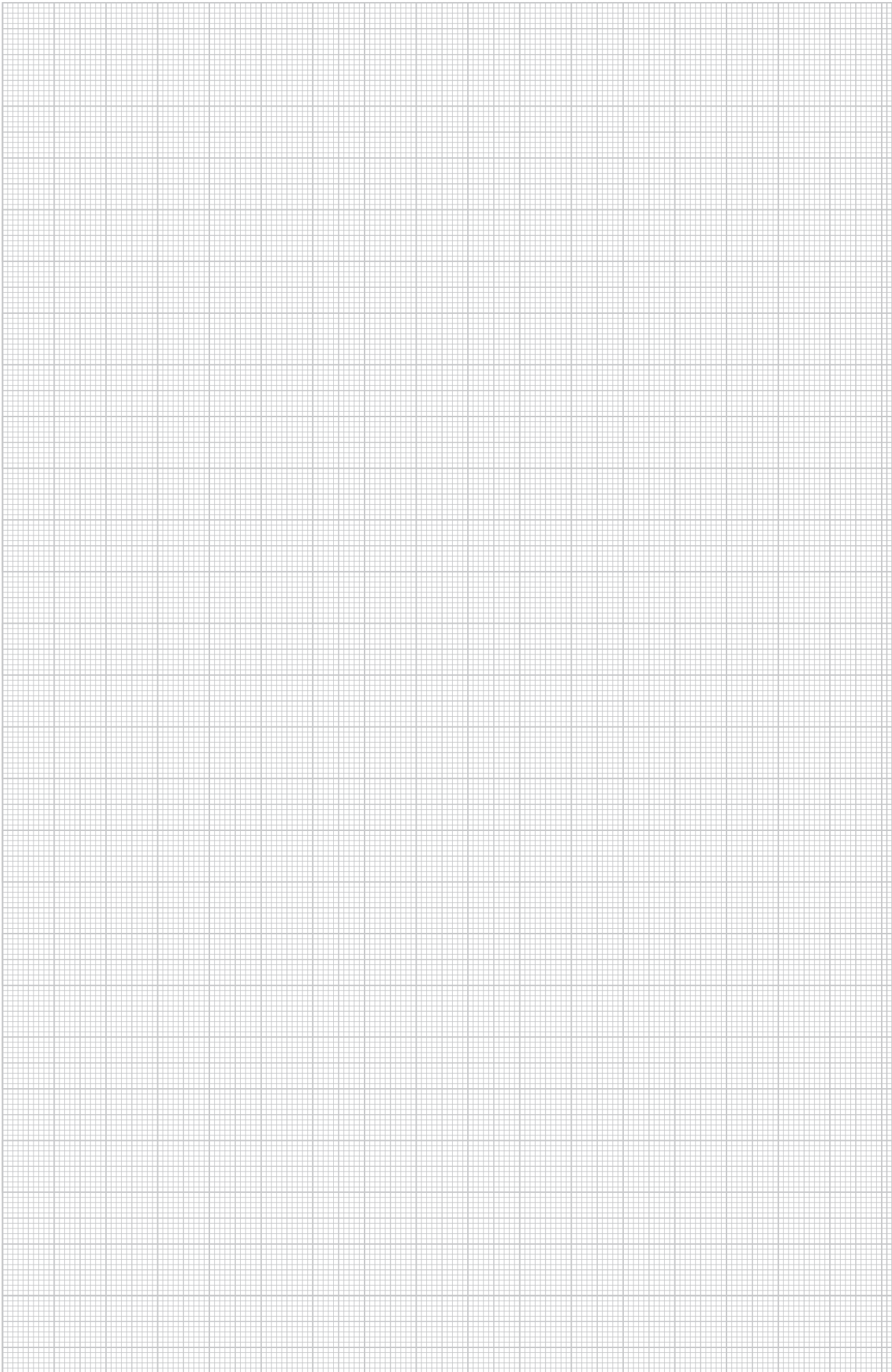

**Terms and conditions of sale and delivery**  
**of OBO BETTERMANN GmbH & Co. KG, OBO BETTERMANN Projekt und Systemtechnik GmbH**  
**and OBO Befestigungselemente GmbH, Menden.**

1. All our supplies and services shall be governed exclusively by the following terms and conditions, including our additional terms and conditions for cable tray business transactions. Any terms and conditions of business and purchasing of the customer shall be valid only if we have acknowledged them in writing. Our quotations are without engagement; they are mere invitations to submit contract offers. Any and all transactions and agreements, including those entered into by our employees and agents shall only be binding upon our written confirmation or invoicing. The foregoing provision shall also apply to any modifications of the agreed formal requirements.

2. The documents and data pertaining to the quotation, such as illustrations, brochures, drawings, dimensions, loading capacity values and weight details are approximate only, unless they are expressly stipulated to be binding.

Samples are non-binding samples for inspection. Any purchase according to sample will be subject to customary deviations and deviations resulting from normal production processes. The properties of the sample shall be no guaranteed quality of the purchase object unless expressly stated otherwise in the confirmation of order. Samples must be returned to us at the latest within four weeks in perfect condition. If they are not returned within this period in proper condition, we shall be entitled to charge the purchase price for the sample in accordance with our current price list. All information on our products, in particular the illustrations, drawings, weight, dimension and performance data included in our quotations and printed matter shall be regarded as approximate average values and shall not represent any quality guarantee.

With regard to products made according to customer drawings, samples and other instructions of the customer, we will not provide any warranty nor assume any liability for the due and proper functioning of the product or for any other defects if and to the extent they are based upon the customer's specifications. The customer shall indemnify us from any third party claims, including claims for product liability as may be asserted against us for damages resulting from the products unless we have caused such damages by intent or gross negligence. The customer shall warrant that the manufacture and supply of products made in accordance with his instructions will not infringe any proprietary rights of third parties. Should any proprietary rights be asserted against us, we shall be entitled, without any legal review of the third party claims, to withdraw from the contract after hearing the customer, unless the third party withdraws the claims asserted against us under its proprietary rights within eight days by written declaration. The customer shall compensate us for any damage sustained as a result of the assertion of proprietary rights. In case of withdrawal, the work we have carried out so far shall be remunerated. Further rights under the statutory provisions shall not be affected thereby.

Any moulds, tools and design data produced by us for the execution of the order shall be our exclusive property. Unless expressly agreed otherwise, the customer shall not have any claims thereto, even if he has contributed to the costs of producing any such moulds, tools and design data.

3. The packing, shipping route and means of transportation shall be left to our discretion in the absence of any other agreements. They shall be charged at their cost price. We will take back undamaged cases, when being returned carriage paid, at 2/3 of the amount invoiced. The one-way or pool pallets used for transport shall be either exchanged upon taking delivery or returned. The smallest packing units stocked and listed may not be broken up for rationalisation reasons. In case of orders for different quantities, the nearest packing unit will be supplied.

We reserve the right to deviate from the agreed delivery quantity, in particular in the case of custom-made products, to a customary extent or in conformity with national or international standards. In case of a demand for adhering to a precise quantity, an express reference is necessary and subject to confirmation.

Master and call orders shall oblige the customer to accept the total quantity on which the master/call order is based. Where no particular call orders are specified in the contract, the total quantity of the master call order must be called within twelve months. If the customer fails to adhere to call deadlines, we shall be entitled to deliver and charge the total quantity in full after four weeks from written notice with reference to the consequences of any failure to call. Our rights arising from any default of the customer shall not be affected thereby.

4. Unless otherwise agreed, our prices are quoted ex works and do not include packing and insurance. The value added tax at the rate applicable on the date of dispatch will be added to our prices. The purchaser shall ensure the correctness of his VAT identification number, which he must notify to us immediately without being asked. He shall undertake to inform both us and the competent domestic tax authority without delay of any change in his name, address and VAT identification number.

Delivery shall be franco domicile within Germany, i.e. carriage and packing prepaid, if the net order value is in excess of € 1,200. For small orders below € 100 (net excluding value added tax), we shall invoice a lower quantity surcharge of € 10 (net) per order. Upon transfer of our supplies and services to a carrier or forwarding agent, at the latest upon their leaving our warehouse or supply plant, the risk shall pass to the recipient, even in case of deliveries free place of destination.

5. Delivery periods and delivery deadlines shall be approximate only unless we have expressly stated in writing that they are binding. Delivery periods shall commence upon receipt of our confirmation of order, but not before clarification of all execution details, ex place of delivery. The customer shall only be entitled to withdraw from the contract after having granted a reasonable extension of time. We reserve the right to make partial deliveries. Claims for damages and reimbursement of expenses - for any reason whatsoever - shall be subject to the provisions set out in article 10.

In the event of any circumstances that are beyond our control within the scope of normal operating risks and obstruct or make impracticable any delivery, we shall be entitled to suspend delivery by the duration of such obstruction plus a reasonable start-up period or to withdraw from the contract for the part not yet fulfilled. The purchaser can demand a statement from us as to whether we wish to deliver within a reasonable period or withdraw. If we fail to make such a statement, the purchaser may withdraw. Our notice to the purchaser shall be deemed to be sufficient evidence that we have been prevented from delivering.

Delivery time is extended in case of such events as labour disputes, strikes and lockouts, orders from the authorities, difficulties with the procurement of materials, spoiled work or post-processing, shutdowns and staff shortage as well as shortage of means of transport, and general occurrence of unforeseen events beyond our scope of influence, by the length of duration of these events.

6. Payments shall be made upon receipt of invoice less a 3% cash discount for payment within 10 days or net after 30 days from date of invoice. Erection work and all paid labour work must be paid within 10 days without deduction of any cash discount. In case of non-cash payments, the date of the credit note will be deemed to be the date of receipt of payment. Payments received shall always be credited first against costs, then against interest and then against the earliest liability. Cheques and bills of exchange shall only be accepted as means of payment.

Any payment by bill of exchange shall be subject to a prior separate and written agreement, whereby all bill costs shall be borne by the customer and no discount can be granted. The customer shall have no right to refuse performance and no right of retention - for any legal reason whatsoever - unless we have acknowledged his claim beforehand in writing or his claim has the force of law.

The customer shall only be entitled to set off claims which have the force of law, are undisputed or acknowledged by us in writing.

7. We shall retain title to the goods supplied by us until all our claims arising from our business transactions with the customer have been satisfied - current account clause - and all bills of exchange or cheques submitted for payment by the customer have been honoured.

Any treatment or processing of goods subject to our retention of title (reserved goods) shall be carried out for us as the manufacturer in accordance with § 950 BGB (German Civil Code) without any obligation on our part. If our reserved goods are to be regarded as the main item or the main item is owned by the customer, full title to the new item shall pass to us when it is created. In other cases, we shall acquire a co-ownership interest in the new item in the proportion of the sales value of our reserved goods to the other goods used for the new item at the time of processing, intermingling, joining or mixing. The customer shall take custody of our ownership or co-ownership interest free of charge; it shall be treated as reserved goods.

Before transfer of title, our goods shall be neither pledged nor assigned as collateral without our prior consent. In addition, any third party rights or pledges shall be notified to us immediately and we shall be given all details and provided all documents necessary for intervention; otherwise the customer must bear our loss. In the latter case, our total claims against the customer shall also be immediately payable.

The customer shall be entitled to sell or to use our reserved goods in the ordinary course of business subject to the condition that the relevant claims are transferred in accordance with article 8 below. This right shall lapse upon the customer's failure to promptly meet his payment obligations towards us or in the event of any cheque or bill protests or his suspension of payments. In such cases, we shall be entitled to take back the goods provisionally at

the customer's expense and to sell them at our duly exercised discretion after a corresponding reminder has been sent to the customer. We will then pass the due amount to the customer's credit.

8. If our goods are sold before payment of our claim, the customer shall be obliged to retain our title against his purchaser until the goods have been paid for in full by the purchaser. The claim arising against the purchaser from such resale as well as any other ancillary rights or security interests of the customer resulting from the sale and any claims for compensation in case of damage to or destruction of our reserved property, including the relevant insurance sum shall hereby be assigned to us. We hereby accept this assignment. Where our co-ownership interest is sold, the relevant claims shall be assigned in the amount corresponding to the value of our interest.

The customer shall, at our request, inform us of his purchasers, notify them of the assignment made and provide us with any and all documents required to assert our rights.

As long as the customer meets his contractual obligations without delay, he shall be authorised to collect the claims assigned. He shall keep the amounts collected on our behalf separately and remit them to us immediately as soon and as far as our claims become due. The authorisation shall lapse in case of any cheque or bill protest of the customer or his definite suspension of payments. The customer shall bear the costs incurred for any action taken against third parties and shall advance them upon request.

If the security provided to us by the retention of title and the anticipatory assignment should exceed the claims to be secured by more than 20%, we shall, at the customer's request, release paid supplies of our choice. Upon payment of all our claims by the customer, assigned claims shall pass to the customer.

9. Any complaints for obvious defects regarding the quantity or quality of our supplies and services that are identifiable upon careful inspection shall without delay, but at the latest within the period of limitation of eight days from arrival of the goods at the address of the customer or the person appointed by him, be notified in writing to us, not to our representatives. Slight deviations in dimensions and designs within the scope of defined technical tolerances shall not give rise to any right of complaint. Any rejected goods may only be returned to us with our prior written authorisation.

In case of justified complaints within the prescribed period, we shall, at our option, take remedial action by way of subsequent performance, by rectifying the defect, supplying non-defective goods or providing a credit note for the lower value calculated.

We shall be entitled to refuse subsequent performance in accordance with the statutory provisions. If we refuse subsequent performance, if any subsequent performance remains unsuccessful or if the customer cannot be reasonably expected to accept any subsequent performance, the latter shall be entitled to withdraw from the contract in compliance with the provisions of the following sentences. The customer shall only be entitled to withdraw from the contract - where a withdrawal is not excluded by law - upon the unsuccessful expiry of a reasonable period for subsequent performance set by him, unless this period was not required under the statutory provisions (§§ 281 para. 2, 323 para. 2, 440, 441 para. 1 BGB (German Civil Code)).

In case of his withdrawal, the customer shall be liable for any deterioration, destruction or loss of use resulting from any negligence or intent on his part. Any claims for damages or reimbursement of expenses of the customer shall be subject to the provisions set out in article 10.

In the case of any fraudulent concealment of a defect or in the case of any provision of a quality guarantee for the goods sold at the time of the passing of risk within the meaning of § 444 BGB (German Civil Code) (seller's declaration that the object sold has a specific property at the time of the passing of risk and that the seller, regardless of any fault on his part, intends to be answerable for any and all consequences resulting from its absence), the customer's rights shall be exclusively governed by the statutory provisions.

We shall - in addition to the statutory grounds for refusal - also be entitled to refuse subsequent performance if and as long as the customer fails to send us, at our request, the rejected goods or a sample thereof; the customer shall have no right of withdrawal for any such refusal. We may further refuse any subsequent performance if the goods concerned have been altered or modified without our consent unless the customer can prove that the defect was not caused by such alteration or modification.

The limitation period for any claims arising from defects shall be one year; in the case of goods which have been used in accordance with their intended purpose for a building and have caused its defectiveness, the limitation period shall be two years. The provisions of §§ 478, 479 BGB (German Civil Code) on recourse in the chain of suppliers shall not be affected thereby.

10. In the case of a pre-contractual, contractual or non-contractual breach of duty, including unsatisfactory delivery, tortious conduct and producer's liability, we shall only be liable for compensatory damages and reimbursement of expenses - subject to further contractual or statutory liability requirements - in the case of intent, gross negligence or slightly negligent breach of a material contractual duty (contractual duty the infringement of which jeopardises the fulfilment of the object of the contract). However - except in the case of intent - our liability shall be limited to the typical contractual damage that was foreseeable at the time the contract was entered into.

The purchaser shall not be permitted to make a claim for expenses incurred in vain. Except for any breach of material duties, our liability for slight negligence shall be excluded, but in any case be limited to the amount of the purchase price.

Any claim asserted by the customer or a third party for payment of a contractual penalty shall be excluded.

With regard to damages caused by delay, we shall only be liable for slight negligence up to the amount of 5% of the purchase price agreed with us.

The exclusions and limitations of liability set forth above shall not apply in the event that a guarantee is given with respect to the quality of the object sold within the meaning of § 444 BGB (German Civil Code) if a defect is fraudulently concealed or in the event of injury to life, physical injury or injury to health, or strict liability under the German Product Liability Act.

Any and all claims for damages against us, for any legal reason whatsoever, shall become statute-barred at the latest after one year from delivery of the goods to the customer, in the case of tortious liability from the time of knowledge, or grossly negligent ignorance, of the circumstances giving rise to the claim and the person liable to pay damages. This provision shall not apply in the case of liability for intent and in the event that a guarantee is given for the quality of the object sold, in the case of fraudulent concealment of a defect or in the event of injury to life, physical injury or injury to health, or strict liability under the German Product Liability Act. Any shorter limitation periods shall take precedence.

11. We shall be entitled to process and store any customer data obtained with regard to or in connection with the business relationship in accordance with the German Federal Data Protection Act, irrespective of whether such data is provided by the purchaser himself or by any third parties.

12. Place of performance for delivery and payment is Menden/Sauerland. The court of competent jurisdiction for any and all disputes, including disputes with regard to bills of exchange and cheques, is the Local Court (Amtsgericht) of Menden or, at our option, the District Court (Landgericht) of Arnsberg, irrespective of the value of the object in dispute. We shall, however, also be entitled to take legal proceedings against the customer at the place of his registered office.

German law shall be exclusively applicable. The application of international purchase laws is hereby excluded.

Should, for any reason whatsoever, individual provisions of our terms and conditions of sale and delivery be invalid, the validity and binding nature of the other provisions shall not be affected thereby. The customer agrees, that the invalid provision shall be replaced by a valid provision that comes as close as possible to the economic meaning of the invalid provision.

13. The prices of products made of brass and copper are subject to certain fluctuations that are based on the relevant DEL listings. The prices of our brass articles are based on a DEL listing of € 150 for Ms 58, those of our copper products on a DEL value for electrolyte copper of € 200.

In case of any increase or reduction in these prices by more than € 15, a five per cent surcharge or deduction shall be made for each 15 points. The calculation of any such surcharges or deductions shall be based on the DEL listing of the date of our receipt of the order.

Valid from January 2010



## Terms and conditions of sale and delivery of OBO BETTERMANN GmbH & Co. KG, OBO BETTERMANN Projekt und Systemtechnik GmbH and OBO Befestigungselemente GmbH, Menden.

1. All our supplies and services shall be governed exclusively by the following terms and conditions, including our additional terms and conditions for cable tray business transactions. Any terms and conditions of business and purchasing of the customer shall be valid only if we have acknowledged them in writing. Our quotations are without engagement; they are mere invitations to submit contract offers. Any and all transactions and agreements, including those entered into by our employees and agents shall only be binding upon our written confirmation or invoicing. The foregoing provision shall also apply to any modifications of the agreed formal requirements.

2. The documents and data pertaining to the quotation, such as illustrations, brochures, drawings, dimensions, loading capacity values and weight details are approximate only, unless they are expressly stipulated to be binding.

Samples are non-binding samples for inspection. Any purchase according to sample will be subject to customary deviations and deviations resulting from normal production processes. The properties of the sample shall be no guaranteed quality of the purchase object unless expressly stated otherwise in the confirmation of order. Samples must be returned to us at the latest within four weeks in perfect condition. If they are not returned within this period in proper condition, we shall be entitled to charge the purchase price for the sample in accordance with our current price list. All information on our products, in particular the illustrations, drawings, weight, dimension and performance data included in our quotations and printed matter shall be regarded as approximate average values and shall not represent any quality guarantee.

With regard to products made according to customer drawings, samples and other instructions of the customer, we will not provide any warranty nor assume any liability for the due and proper functioning of the product or for any other defects if and to the extent they are based upon the customer's specifications. The customer shall indemnify us from any third party claims, including claims for product liability as may be asserted against us for damages resulting from the products unless we have caused such damages by intent or gross negligence. The customer shall warrant that the manufacture and supply of products made in accordance with his instructions will not infringe any proprietary rights of third parties. Should any proprietary rights be asserted against us, we shall be entitled, without any legal review of the third party claims, to withdraw from the contract after hearing the customer, unless the third party withdraws the claims asserted against us under its proprietary rights within eight days by written declaration. The customer shall compensate us for any damage sustained as a result of the assertion of proprietary rights. In case of withdrawal, the work we have carried out so far shall be remunerated. Further rights under the statutory provisions shall not be affected thereby.

Any moulds, tools and design data produced by us for the execution of the order shall be our exclusive property. Unless expressly agreed otherwise, the customer shall not have any claims thereto, even if he has contributed to the costs of producing any such moulds, tools and design data.

3. The packing, shipping route and means of transportation shall be left to our discretion in the absence of any other agreements. They shall be charged at their cost price. We will take back undamaged cases, when being returned carriage paid, at 2/3 of the amount invoiced. The one-way or pool pallets used for transport shall be either exchanged upon taking delivery or returned. The smallest packing units stocked and listed may not be broken up for rationalisation reasons. In case of orders for different quantities, the nearest packing unit will be supplied.

We reserve the right to deviate from the agreed delivery quantity, in particular in the case of custom-made products, to a customary extent or in conformity with national or international standards. In case of a demand for adhering to a precise quantity, an express reference is necessary and subject to confirmation.

Master and call orders shall oblige the customer to accept the total quantity on which the master/call order is based. Where no particular call orders are specified in the contract, the total quantity of the master call order must be called within twelve months. If the customer fails to adhere to call deadlines, we shall be entitled to deliver and charge the total quantity in full after four weeks from written notice with reference to the consequences of any failure to call. Our rights arising from any default of the customer shall not be affected thereby.

4. Unless otherwise agreed, our prices are quoted ex works and do not include packing and insurance. The value added tax at the rate applicable on the date of dispatch will be added to our prices. The purchaser shall ensure the correctness of his VAT identification number, which he must notify to us immediately without being asked. He shall undertake to inform both us and the competent domestic tax authority without delay of any change in his name, address and VAT identification number.

Delivery shall be franco domicile within Germany, i.e. carriage and packing prepaid, if the net order value is in excess of € 1,200. For small orders below € 100 (net excluding value added tax), we shall invoice a lower quantity surcharge of € 10 (net) per order. Upon transfer of our supplies and services to a carrier or forwarding agent, at the latest upon their leaving our warehouse or supply plant, the risk shall pass to the recipient, even in case of deliveries free place of destination.

5. Delivery periods and delivery deadlines shall be approximate only unless we have expressly stated in writing that they are binding. Delivery periods shall commence upon receipt of our confirmation of order, but not before clarification of all execution details, ex place of delivery. The customer shall only be entitled to withdraw from the contract after having granted a reasonable extension of time. We reserve the right to make partial deliveries. Claims for damages and reimbursement of expenses - for any reason whatsoever - shall be subject to the provisions set out in article 10.

In the event of any circumstances that are beyond our control within the scope of normal operating risks and obstruct or make impracticable any delivery, we shall be entitled to suspend delivery by the duration of such obstruction plus a reasonable start-up period or to withdraw from the contract for the part not yet fulfilled. The purchaser can demand a statement from us as to whether we wish to deliver within a reasonable period or withdraw. If we fail to make such a statement, the purchaser may withdraw. Our notice to the purchaser shall be deemed to be sufficient evidence that we have been prevented from delivering.

Delivery time is extended in case of such events as labour disputes, strikes and lockouts, orders from the authorities, difficulties with the procurement of materials, spoiled work or post-processing, shutdowns and staff shortage as well as shortage of means of transport, and general occurrence of unforeseen events beyond our scope of influence, by the length of duration of these events.

6. Payments shall be made upon receipt of invoice less a 3% cash discount for payment within 10 days or net after 30 days from date of invoice. Erection work and all paid labour work must be paid within 10 days without deduction of any cash discount. In case of non-cash payments, the date of the credit note will be deemed to be the date of receipt of payment. Payments received shall always be credited first against costs, then against interest and then against the earliest liability. Cheques and bills of exchange shall only be accepted as means of payment.

Any payment by bill of exchange shall be subject to a prior separate and written agreement, whereby all bill costs shall be borne by the customer and no discount can be granted. The customer shall have no right to refuse performance and no right of retention - for any legal reason whatsoever - unless we have acknowledged his claim beforehand in writing or his claim has the force of law.

The customer shall only be entitled to set off claims which have the force of law, are undisputed or acknowledged by us in writing.

7. We shall retain title to the goods supplied by us until all our claims arising from our business transactions with the customer have been satisfied - current account clause - and all bills of exchange or cheques submitted for payment by the customer have been honoured.

Any treatment or processing of goods subject to our retention of title (reserved goods) shall be carried out for us as the manufacturer in accordance with § 950 BGB (German Civil Code) without any obligation on our part. If our reserved goods are to be regarded as the main item or the main item is owned by the customer, full title to the new item shall pass to us when it is created. In other cases, we shall acquire a co-ownership interest in the new item in the proportion of the sales value of our reserved goods to the other goods used for the new item at the time of processing, intermingling, joining or mixing. The customer shall take custody of our ownership or co-ownership interest free of charge; it shall be treated as reserved goods.

Before transfer of title, our goods shall be neither pledged nor assigned as collateral without our prior consent. In addition, any third party rights or pledges shall be notified to us immediately and we shall be given all details and provided all documents necessary for intervention; otherwise the customer must bear our loss. In the latter case, our total claims against the customer shall also be immediately payable.

The customer shall be entitled to sell or to use our reserved goods in the ordinary course of business subject to the condition that the relevant claims are transferred in accordance with article 8 below. This right shall lapse upon the customer's failure to promptly meet his payment obligations towards us or in the event of any cheque or bill protests or his suspension of payments. In such cases, we shall be entitled to take back the goods provisionally at

the customer's expense and to sell them at our duly exercised discretion after a corresponding reminder has been sent to the customer. We will then pass the due amount to the customer's credit.

8. If our goods are sold before payment of our claim, the customer shall be obliged to retain our title against his purchaser until the goods have been paid for in full by the purchaser. The claim arising against the purchaser from such resale as well as any other ancillary rights or security interests of the customer resulting from the sale and any claims for compensation in case of damage to or destruction of our reserved property, including the relevant insurance sum shall hereby be assigned to us. We hereby accept this assignment. Where our co-ownership interest is sold, the relevant claims shall be assigned in the amount corresponding to the value of our interest.

The customer shall, at our request, inform us of his purchasers, notify them of the assignment made and provide us with any and all documents required to assert our rights.

As long as the customer meets his contractual obligations without delay, he shall be authorised to collect the claims assigned. He shall keep the amounts collected on our behalf separately and remit them to us immediately as soon and as far as our claims become due. The authorisation shall lapse in case of any cheque or bill protest of the customer or his definite suspension of payments. The customer shall bear the costs incurred for any action taken against third parties and shall advance them upon request.

If the security provided to us by the retention of title and the anticipatory assignment should exceed the claims to be secured by more than 20%, we shall, at the customer's request, release paid supplies of our choice. Upon payment of all our claims by the customer, assigned claims shall pass to the customer.

9. Any complaints for obvious defects regarding the quantity or quality of our supplies and services that are identifiable upon careful inspection shall without delay, but at the latest within the period of limitation of eight days from arrival of the goods at the address of the customer or the person appointed by him, be notified in writing to us, not to our representatives. Slight deviations in dimensions and designs within the scope of defined technical tolerances shall not give rise to any right of complaint. Any rejected goods may only be returned to us with our prior written authorisation.

In case of justified complaints within the prescribed period, we shall, at our option, take remedial action by way of subsequent performance, by rectifying the defect, supplying non-defective goods or providing a credit note for the lower value calculated.

We shall be entitled to refuse subsequent performance in accordance with the statutory provisions. If we refuse subsequent performance, if any subsequent performance remains unsuccessful or if the customer cannot be reasonably expected to accept any subsequent performance, the latter shall be entitled to withdraw from the contract in compliance with the provisions of the following sentences. The customer shall only be entitled to withdraw from the contract - where a withdrawal is not excluded by law - upon the unsuccessful expiry of a reasonable period for subsequent performance set by him, unless this period was not required under the statutory provisions (§§ 281 para. 2, 323 para. 2, 440, 441 para. 1 BGB (German Civil Code)).

In case of his withdrawal, the customer shall be liable for any deterioration, destruction or loss of use resulting from any negligence or intent on his part. Any claims for damages or reimbursement of expenses of the customer shall be subject to the provisions set out in article 10.

In the case of any fraudulent concealment of a defect or in the case of any provision of a quality guarantee for the goods sold at the time of the passing of risk within the meaning of § 444 BGB (German Civil Code) (seller's declaration that the object sold has a specific property at the time of the passing of risk and that the seller, regardless of any fault on his part, intends to be answerable for any and all consequences resulting from its absence), the customer's rights shall be exclusively governed by the statutory provisions.

We shall - in addition to the statutory grounds for refusal - also be entitled to refuse subsequent performance if and as long as the customer fails to send us, at our request, the rejected goods or a sample thereof; the customer shall have no right of withdrawal for any such refusal. We may further refuse any subsequent performance if the goods concerned have been altered or modified without our consent unless the customer can prove that the defect was not caused by such alteration or modification.

The limitation period for any claims arising from defects shall be one year; in the case of goods which have been used in accordance with their intended purpose for a building and have caused its defectiveness, the limitation period shall be two years. The provisions of §§ 478, 479 BGB (German Civil Code) on recourse in the chain of suppliers shall not be affected thereby.

10. In the case of a pre-contractual, contractual or non-contractual breach of duty, including unsatisfactory delivery, tortious conduct and producer's liability, we shall only be liable for compensatory damages and reimbursement of expenses - subject to further contractual or statutory liability requirements - in the case of intent, gross negligence or slightly negligent breach of a material contractual duty (contractual duty the infringement of which jeopardises the fulfilment of the object of the contract). However - except in the case of intent - our liability shall be limited to the typical contractual damage that was foreseeable at the time the contract was entered into.

The purchaser shall not be permitted to make a claim for expenses incurred in vain. Except for any breach of material duties, our liability for slight negligence shall be excluded, but in any case be limited to the amount of the purchase price.

Any claim asserted by the customer or a third party for payment of a contractual penalty shall be excluded.

With regard to damages caused by delay, we shall only be liable for slight negligence up to the amount of 5% of the purchase price agreed with us.

The exclusions and limitations of liability set forth above shall not apply in the event that a guarantee is given with respect to the quality of the object sold within the meaning of § 444 BGB (German Civil Code) if a defect is fraudulently concealed or in the event of injury to life, physical injury or injury to health, or strict liability under the German Product Liability Act.

Any and all claims for damages against us, for any legal reason whatsoever, shall become statute-barred at the latest after one year from delivery of the goods to the customer, in the case of tortious liability from the time of knowledge, or grossly negligent ignorance, of the circumstances giving rise to the claim and the person liable to pay damages. This provision shall not apply in the case of liability for intent and in the event that a guarantee is given for the quality of the object sold, in the case of fraudulent concealment of a defect or in the event of injury to life, physical injury or injury to health, or strict liability under the German Product Liability Act. Any shorter limitation periods shall take precedence.

11. We shall be entitled to process and store any customer data obtained with regard to or in connection with the business relationship in accordance with the German Federal Data Protection Act, irrespective of whether such data is provided by the purchaser himself or by any third parties.

12. Place of performance for delivery and payment is Menden/Sauerland. The court of competent jurisdiction for any and all disputes, including disputes with regard to bills of exchange and cheques, is the Local Court (Amtsgericht) of Menden or, at our option, the District Court (Landgericht) of Arnsberg, irrespective of the value of the object in dispute. We shall, however, also be entitled to take legal proceedings against the customer at the place of his registered office.

German law shall be exclusively applicable. The application of international purchase laws is hereby excluded.

Should, for any reason whatsoever, individual provisions of our terms and conditions of sale and delivery be invalid, the validity and binding nature of the other provisions shall not be affected thereby. The customer agrees, that the invalid provision shall be replaced by a valid provision that comes as close as possible to the economic meaning of the invalid provision.

13. The prices of products made of brass and copper are subject to certain fluctuations that are based on the relevant DEL listings. The prices of our brass articles are based on a DEL listing of € 150 for Ms 58, those of our copper products on a DEL value for electrolyte copper of € 200.

In case of any increase or reduction in these prices by more than € 15, a five per cent surcharge or deduction shall be made for each 15 points. The calculation of any such surcharges or deductions shall be based on the DEL listing of the date of our receipt of the order.

Valid from January 2010





#### **QR-Code**

With the QR Code you have direct access to our products on the Internet.

You can find further information on the QR Code at [www.obo-bettermann.com](http://www.obo-bettermann.com).

#### **OBO BETTERMANN GmbH & Co. KG**

P.O. Box 1120  
58694 Menden, Germany

#### **Customer Service Germany**

Tel. +49 (0)2373 89-1500  
Fax +49 (0)2373 89-7777  
E-mail: [info@obo.de](mailto:info@obo.de)

[www.obo-bettermann.com](http://www.obo-bettermann.com)